

Analog Devices Welcomes Hittite Microwave Corporation

NO CONTENT ON THE ATTACHED DOCUMENT HAS CHANGED



HMC1133* Product Page Quick Links

Last Content Update: 08/30/2016

[Comparable Parts](#)

View a parametric search of comparable parts

[Evaluation Kits](#)

- EV1HMC1133LP5 Evaluation Board

[Documentation](#)

Data Sheet

- HMC1133LP5E: GaAs MMIC 6-BIT Digital Phase Shifter, 4.8-6.2 GHz Data Sheet

[Design Resources](#)

- HMC1133 Material Declaration
- PCN-PDN Information
- Quality And Reliability
- Symbols and Footprints

[Discussions](#)

View all HMC1133 EngineerZone Discussions

[Sample and Buy](#)

Visit the product page to see pricing options

[Technical Support](#)

Submit a technical question or find your regional support number

THIS PAGE INTENTIONALLY LEFT BLANK



GaAs MMIC 6-BIT DIGITAL PHASE SHIFTER, 4.8 - 6.2 GHz

Typical Applications

The HMC1133LP5E is ideal for:

- EW Receivers
- Weather & Military Radar
- Satellite Communications
- Beamforming Modules
- Phase Cancellation

Features

- Low RMS Phase Error: 2.8°
- Low Insertion Loss: 5 dB
- High Linearity: +46 dBm
- Positive Control Logic
- 360° Coverage, LSB = 5.625°
- 32 Lead 5x5mm SMT Package: 25mm²

Functional Diagram

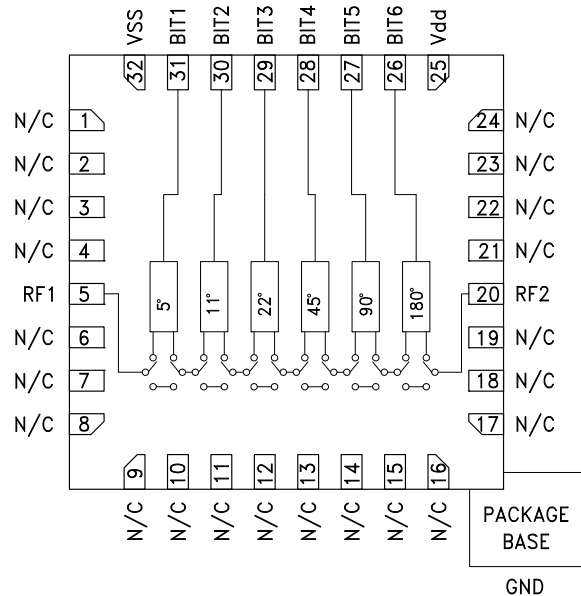

General Description

The HMC1133LP5E is a 6-bit digital phase shifter which is rated from 4.0 to 7 GHz, providing 360 degrees of phase coverage, with a LSB of 5.625 degrees. The HMC1133LP5E features very low RMS phase error of 2.8 degrees and extremely low insertion loss variation of ±0.4 dB across all phase states. This high accuracy phase shifter is controlled with positive control logic of 0/+5V. The HMC1133LP5E is housed in a compact 5x5 mm plastic leadless SMT package and is internally matched to 50 Ohms with no external components.

Electrical Specifications

$T_A = +25^\circ\text{C}$, $V_{SS} = -5\text{V}$, $V_{DD} = +5\text{V}$, BIT1 to BIT6 = 0/ +5V, 50 Ohm System

Parameter	Min.	Typ.	Max.	Units
Frequency Range	4.8		6.2	GHz
Insertion Loss*	3.5		6.8	dB
Input Return Loss*		13		dB
Output Return Loss*		15		dB
Phase Error*		±5.625	±10	deg
RMS Phase Error		2.8		deg
Insertion Loss Variation*		±0.4		dB
Input Power for 1 dB Compression		30		dBm
Input Third Order Intercept		46		dBm
Control Voltage Current		10		μA
Bias Control Current		13.5		mA

*Note: Major States Shown



**GaAs MMIC 6-BIT DIGITAL
PHASE SHIFTER, 4.8 - 6.2 GHz**

Insertion Loss, Major States Only

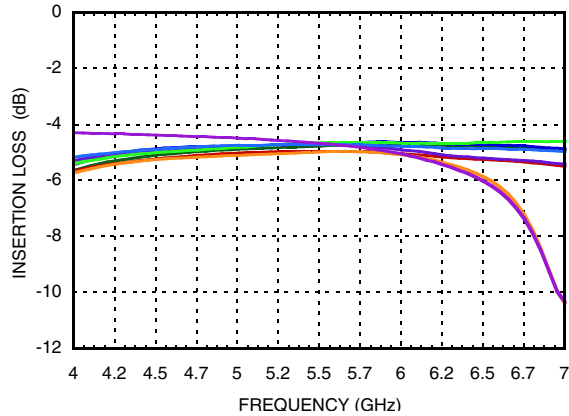

Normalized Loss, Major States Only

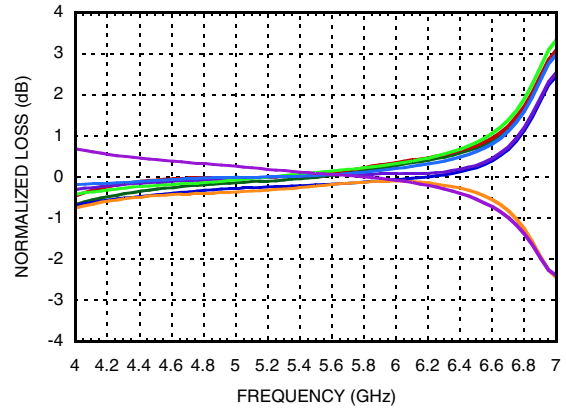

Input Return Loss, Major States Only

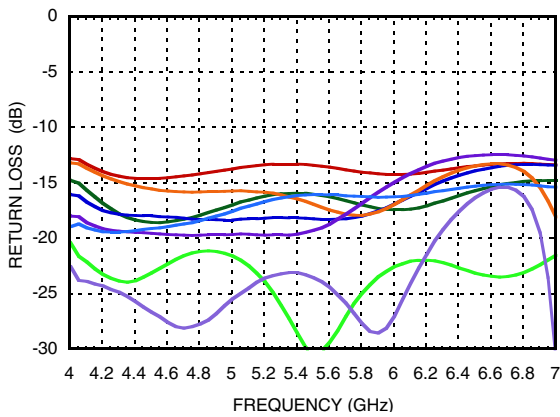

Phase Error, Major States Only

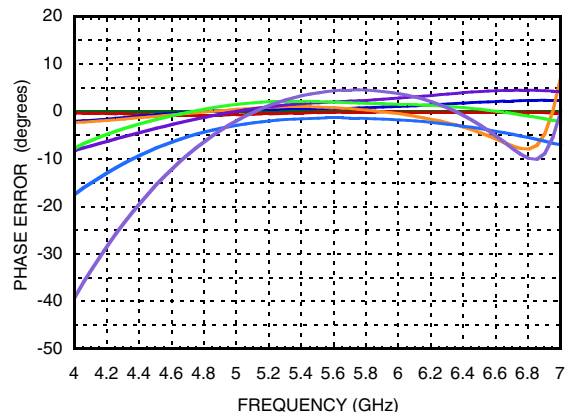

Output Return Loss, Major States Only

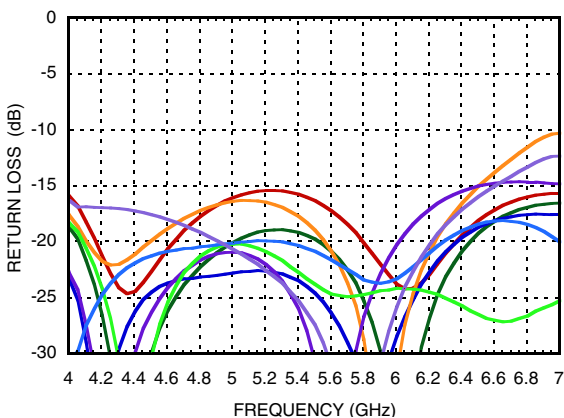

**Relative Phase Shift
Major States Including All Bits**

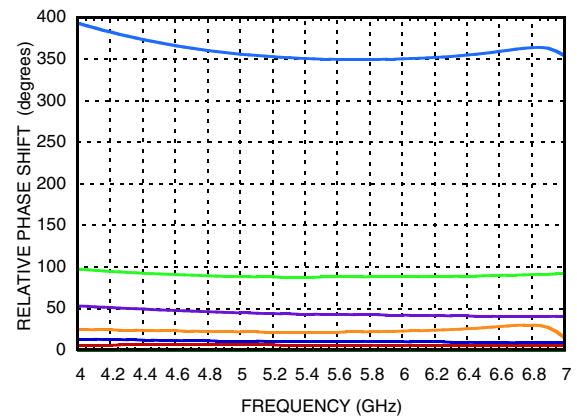



**GaAs MMIC 6-BIT DIGITAL
 PHASE SHIFTER, 4.8 - 6.2 GHz**

**Relative Phase Shift,
 RMS, Average, Max, All States**

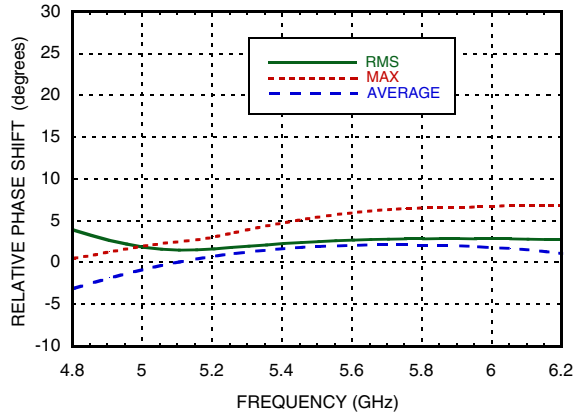

Input IP3, Major States Only

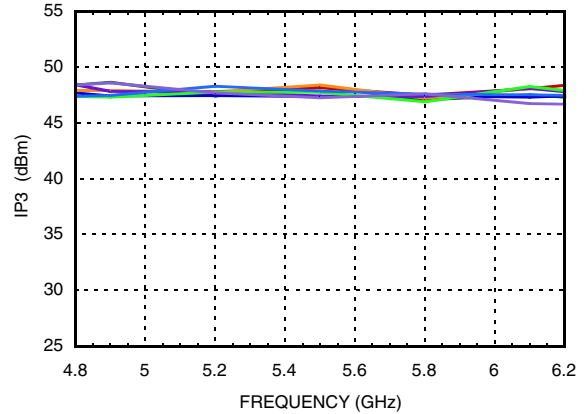

Input IP2, Major States Only

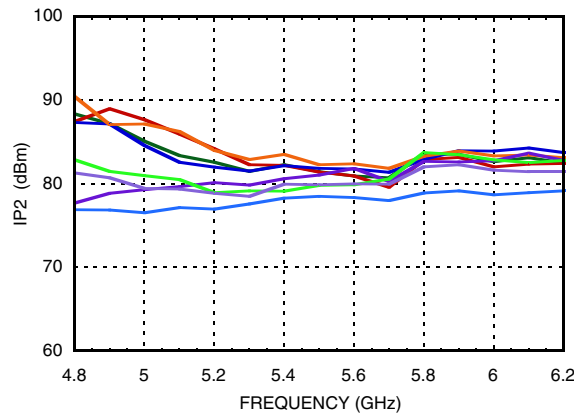

Input P1dB, Major States Only

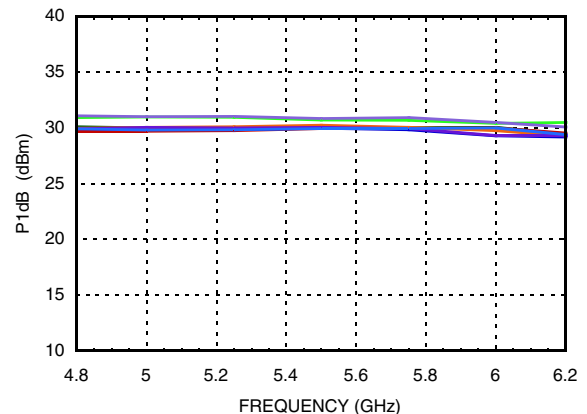

RMS Phase Error vs. Temperature

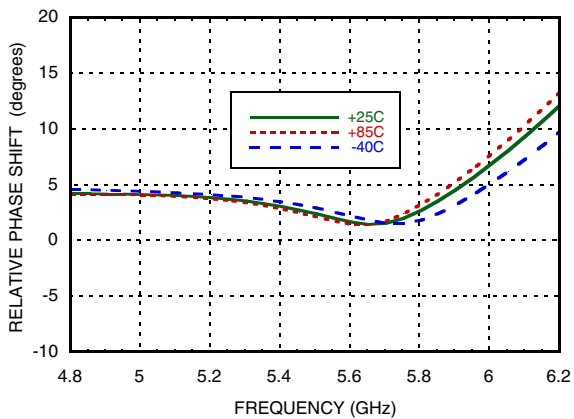

**Insertion Loss vs. Temperature,
 Major States Only**

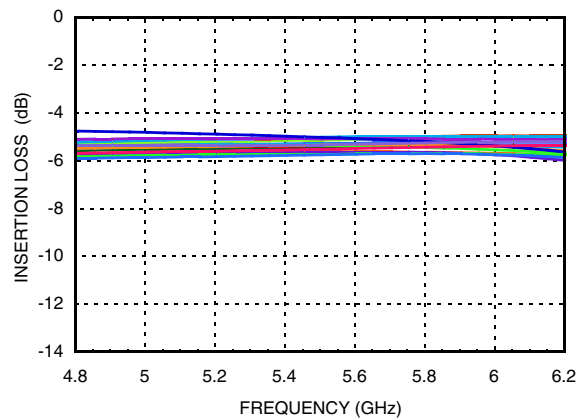



**GaAs MMIC 6-BIT DIGITAL
PHASE SHIFTER, 4.8 - 6.2 GHz**

Phase Error vs. State

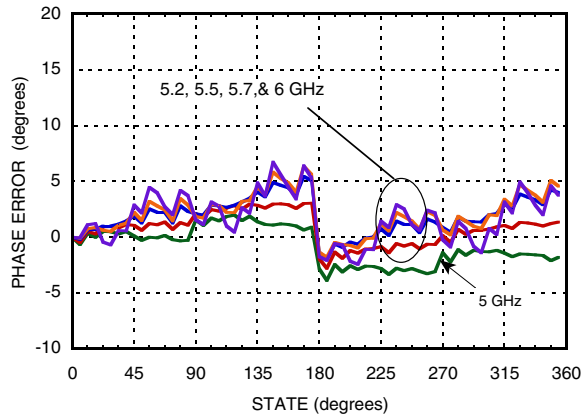

Bias Voltage & Current

Vdd	Idd
5.0	6mA
Vss	Iss
-5.0	7.5mA

Control Voltage

State	Bias Condition
Low (0)	0 to 0.2 Vdc
High (1)	Vdd ±0.2 Vdc @ 10 µA Typ.

Absolute Maximum Ratings

Input Power (RFIN)	29 dBm (T= +85 °C)
Bias Voltage Range (Vdd)	-0.2 to +7V
Bias Voltage Range (Vss)	+0.2 to -7V
Channel Temperature (Tc)	150 °C
Thermal Resistance (channel to ground paddle)	109 °C/W
Storage Temperature	-65 to +150 °C
Operating Temperature	-40 to +85 °C
ESD sensitivity (HBM)	Class1A (passed 250V)



**ELECTROSTATIC SENSITIVE DEVICE
OBSERVE HANDLING PRECAUTIONS**

Truth Table

Control Voltage Input						Phase Shift (Degrees) RFIN - RFOUT
Bit 1	Bit 2	Bit 3	Bit 4	Bit 5	Bit 6	
0	0	0	0	0	0	Reference*
1	0	0	0	0	0	5.625
0	1	0	0	0	0	11.25
0	0	1	0	0	0	22.5
0	0	0	1	0	0	45.0
0	0	0	0	1	0	90.0
0	0	0	0	0	1	180.0
1	1	1	1	1	1	354.375

Any combination of the above states will provide a phase shift approximately equal to the sum of the bits selected.
*Reference corresponds to monotonic setting



**GaAs MMIC 6-BIT DIGITAL
PHASE SHIFTER, 4.8 - 6.2 GHz**

Outline Drawing

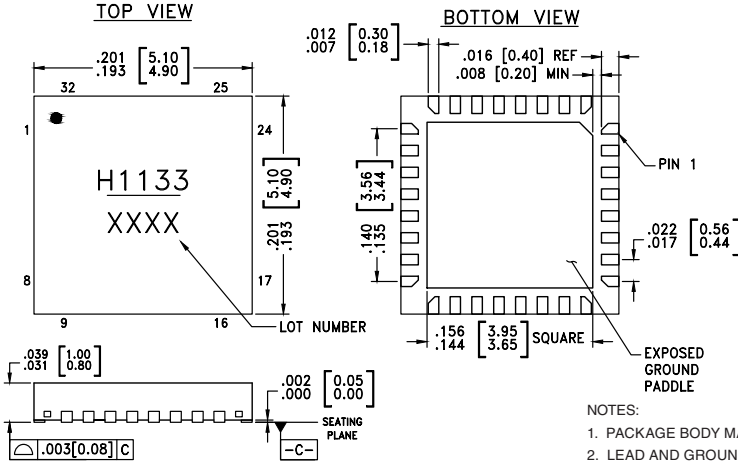

NOTES:

1. PACKAGE BODY MATERIAL: ALUMINA
2. LEAD AND GROUND PADDLE PLATING: 30-80 MICROINCHES GOLD OVER 50 MICROINCHES MINIMUM NICKEL.
3. DIMENSIONS ARE IN INCHES [MILLIMETERS].
4. LEAD SPACING TOLERANCE IS NON-CUMULATIVE
5. PACKAGE WARP SHALL NOT EXCEED 0.05mm DATUM -C-
6. ALL GROUND LEADS AND GROUND PADDLE MUST BE SOLDERED TO PCB RF GROUND.
7. CLASSIFIED AS MOISTURE SENSITIVITY LEVEL (MSL) 1.

Package Information

Part Number	Package Body Material	Lead Finish	MSL Rating	Package Marking [2]
HMC1133LP5E	RoHS-compliant Low Stress Injection Molded Plastic	100% matte Sn	MSL3 [1]	H1133 XXXX

[1] Max peak reflow temperature of 260 °C
[2] 4-Digit lot number XXXX

Pin Descriptions

Pin Number	Function	Description	Interface Schematic
1 - 4, 6 - 19, 21 - 24	N/C	No connection required. These pins may be connected to RF/DC ground without affecting performance.	
5	RF1	This port is DC coupled and matched to 50 Ohms.	RF1 ○ —
26 - 31	BIT6, BIT5, BIT4, BIT3, BIT2, BIT1	Control Input. See truth table and control voltage tables.	
32	Vss	Voltage supply.	
25	Vdd	Voltage supply.	
20	RF2	This port is DC coupled and matched to 50 Ohms.	— ○ RF2
	GND	Exposed ground paddle must be connected to RF/DC ground	○ GND ⏏

Evaluation PCB

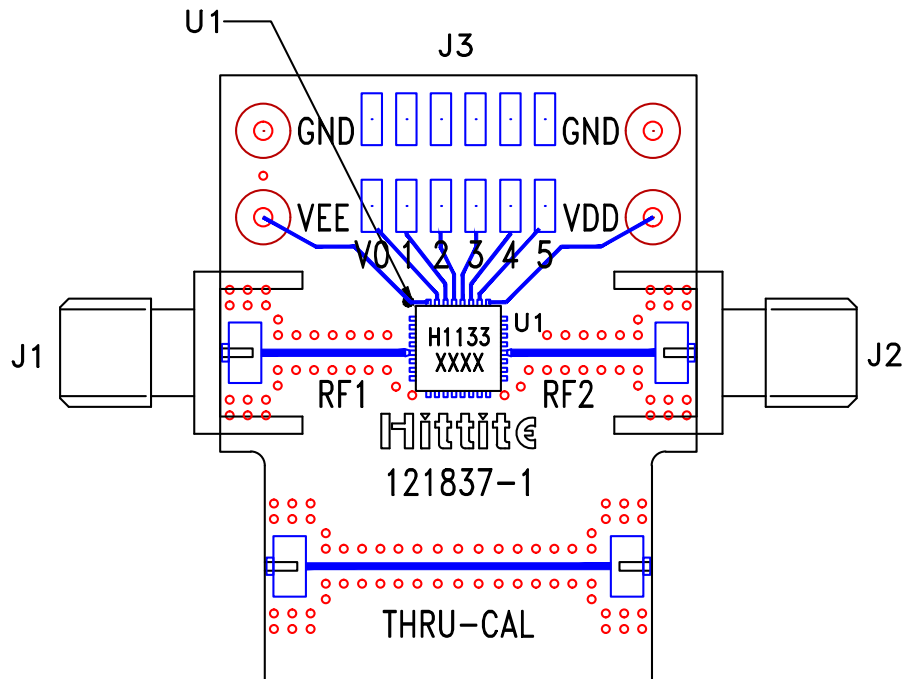

List of Materials for Evaluation PCB EV1HMC1133LP5 [1][3]

Item	Description
J1 - J2	PCB Mount SMA RF Connector
J3 - J4	Molex Header 2mm
U1	HMC1133LP5 6-Bit Digital Phase Shifter
PCB [2]	121837 Evaluation PCB

[1] Reference this number when ordering complete evaluation PCB

[2] Circuit Board Material: Rogers 4350 or Arlon 25FR

[3] Please refer to part's pin description and functional diagram for pin out assignments on evaluation board.

The circuit board used in the final application should use RF circuit design techniques. Signal lines should have 50 ohm impedance while the package ground leads and exposed paddle should be connected directly to the ground plane similar to that shown. A sufficient number of via holes should be used to connect the top and bottom ground planes. The evaluation board should be mounted to an appropriate heat sink. The evaluation circuit board shown is available from Hittite upon request.