

SPDT SWITCH GaAs MMIC

■ GENERAL DESCRIPTION

NJG1608KB2 is a SPDT switch IC featured low insertion loss, medium handling power and high isolation.

This device is suitable for switching of Tx/Rx signals at sub-microwave applications.

This switch exhibits wide frequency range from 100MHz to 6.0GHz at low operating voltage of 2.5V, and is operated up to 25dBm at 3.0V operating voltage.

The Pb free FLP6 package is applied.

■ PACKAGE OUTLINE



NJG1608KB2

■ FEATURES

- Single low voltage control +2.5~+6.5V
- Low insertion loss
 - 0.3dB typ. @f=2.5GHz
 - 0.35dB typ. @f=2.5GHz
 - 0.6dB typ. @f=5.85GHz
- High isolation
 - 29dB typ. @f=2.5GHz
 - 30dB typ. @f=2.5GHz,
 - 18dB typ. @f=5.85GHz
- Handling power 30dBm typ. @f=2.5GHz, $V_{CTL}=3.0V$
- Ultra small & ultra thin package FLP6-B2 (Package size: 2.0x2.1x0.75mm)

■ PIN CONFIGURATION

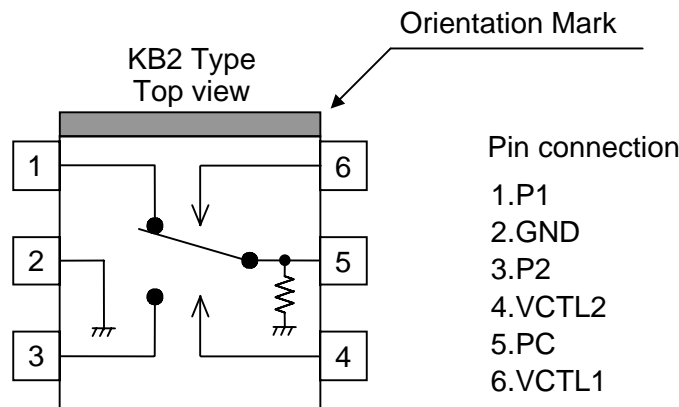

■ TRUTH TABLE

“H”= $V_{CTL(H)}$, “L”= $V_{CTL(L)}$

V_{CTL1}	H	L
V_{CTL2}	L	H
PC – P1	OFF	ON
PC – P2	ON	OFF

NJG1608KB2

■ ABSOLUTE MAXIMUM RATINGS

($T_a=25^{\circ}\text{C}$, $Z_s=Z_l=50\Omega$)

PARAMETER	SYMBOL	CONDITIONS	RATINGS	UNITS
Input Power	P_{in}	$V_{CTL(L)}=0\text{V}$, $V_{CTL(H)}=3.0\text{V}$	32	dBm
Control Voltage	V_{CTL}	$V_{CTL(H)}-V_{CTL(L)}$	7.5	V
Power Dissipation	P_D	At on PCB board	550	mW
Operating Temp.	T_{opr}		-40~+85	$^{\circ}\text{C}$
Storage Temp.	T_{stg}		-55~+150	$^{\circ}\text{C}$

■ ELECTRICAL CHARACTERISTICS

(with application circuit, $V_{CTL(L)}=0\text{V}$, $V_{CTL(H)}=3.0\text{V}$, $Z_s=Z_l=50\Omega$, $T_a=25^{\circ}\text{C}$)

PARAMETERS	SYMBOL	CONDITIONS	MIN	TYP	MAX	UNITS
Operating voltage (LOW)	$V_{CTL(L)}$		-0.2	0	0.2	V
Operating voltage (HIGH)	$V_{CTL(H)}$		2.5	3.0	6.5	V
Control current	I_{CTL}	$f=2.0\text{GHz}$	-	5	10	μA
Insertion loss 1	LOSS1	$f=2.0\text{GHz}$	-	0.3	0.45	dB
Insertion loss 2	LOSS2	$f=2.5\text{GHz}$	-	0.35	0.5	dB
Insertion loss 3	LOSS3	$f=5.85\text{GHz}$		0.6	0.8	dB
Isolation 1 (PC-P1, PC-P2, P1-P2)	ISL1	$f=2.0\text{GHz}$,	26	29	-	dB
Isolation 2 (PC-P1, PC-P2, P1-P2)	ISL2	$f=2.5\text{GHz}$,	27	30	-	dB
Isolation 3 (PC-P1, PC-P2, P1-P2)	ISL3	$f=5.85\text{GHz}$	16	18		dB
Pin at 1dB compression point 1	$P_{-1\text{dB}}(1)$	$f=2.5\text{GHz}$	28	30	-	dBm
Pin at 1dB compression point 2	$P_{-1\text{dB}}(2)$	$f=5.85\text{GHz}$	25	27	-	dBm
VSWR (PC, P1, P2)	VSWR	$f=0.1\sim 5.85\text{GHz}$, ON State	-	1.4	1.6	
Switching time	T_{sw}	$f_{in}=0.1\sim 5.85\text{GHz}$	-	100	-	ns

■ TERMINAL INFORMATION

No.	SYMBOL	DESCRIPTION
1	P1	RF port. This port is connected with PC port by controlling 4 th pin ($V_{CTL(H)}$) to 2.5~6.5V and 6 th pin($V_{CTL(L)}$) to -0.2~+0.2V. An external capacitor is required to block the DC bias voltage of internal circuit
2	GND	Ground terminal. Please connect this terminal with ground plane as close as possible for excellent RF performance.
3	P2	RF port. This port is connected with PC port by controlling 6 th pin ($V_{CTL(H)}$) to 2.5~6.5V and 4 th pin($V_{CTL(L)}$) to -0.2~+0.2V. An external capacitor is required to block the DC bias voltage of internal circuit.
4	VCTL2	Control port 2. The voltage of this port controls PC to P1 state. The 'ON' and 'OFF' state is toggled by controlling voltage of this terminal such as high-state (2.5~6.5V) or low-state (-0.2~+0.2V). The voltage of 6 th pin have to be set to opposite state. The bypass capacitor has to be chosen to reduce switching time delay from 10pF~1000pF range.
5	PC	Common RF port. In order to block the DC bias voltage of internal circuit, an external capacitor is required.
6	VCTL1	Control port 1. The voltage of this port controls PC to P2 state. The 'ON' and 'OFF' state is toggled by controlling voltage of this terminal such as high-state (2.5~6.5V) or low-state (-0.2~+0.2V). The voltage of 4 th pin have to be set to opposite state. The bypass capacitor has to be chosen to reduce switching time delay from 10pF~1000pF range.

NJG1608KB2

■ ELECTRICAL CHARACTERISTICS

(0.1~6.0GHz, with application circuit, without DC Blocking Capacitor, Losses of external circuit are excluded.)

PC-P1 Insertion Loss vs. Frequency
(VCTL1=0V, VCTL2=3V)

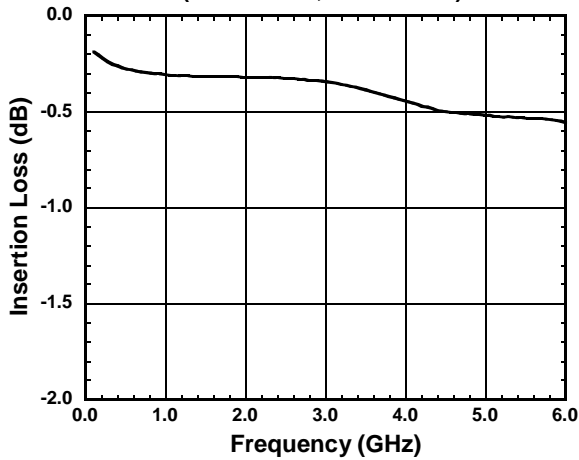

PC-P2 Insertion Loss vs. Frequency
(VCTL1=3V, VCTL2=0V)

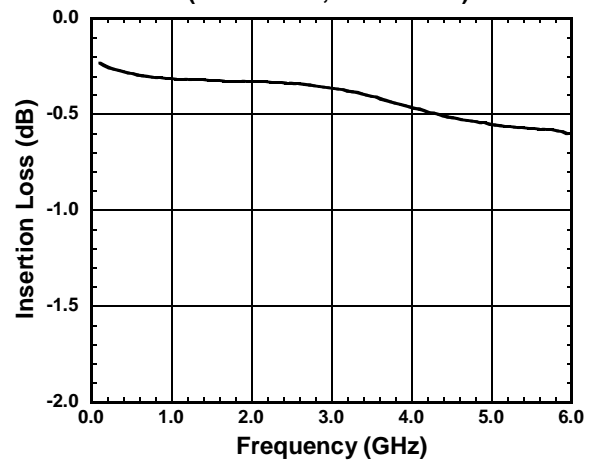

PC VSWR vs. Frequency

(PC-P1 ON, VCTL1=0V, VCTL2=3V)

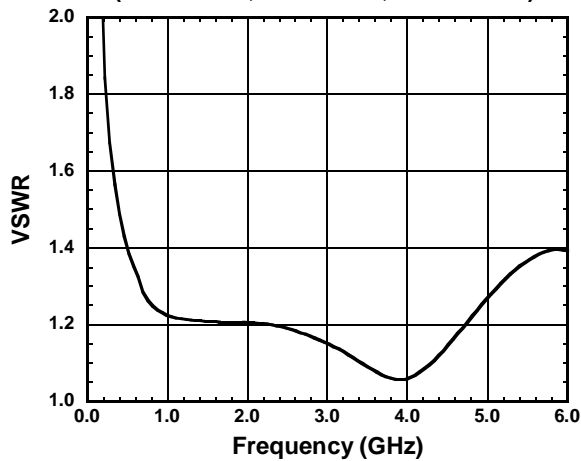

PC-P1 Isolation vs. Frequency

(VCTL1=3V, VCTL2=0V)

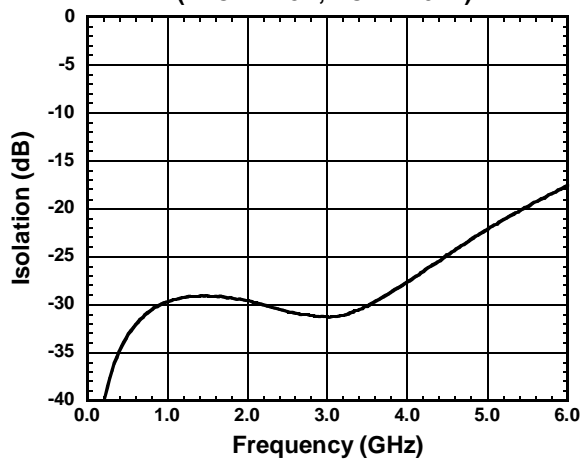

PC-P2 Isolation vs. Frequency

(VCTL1=0V, VCTL2=3V)

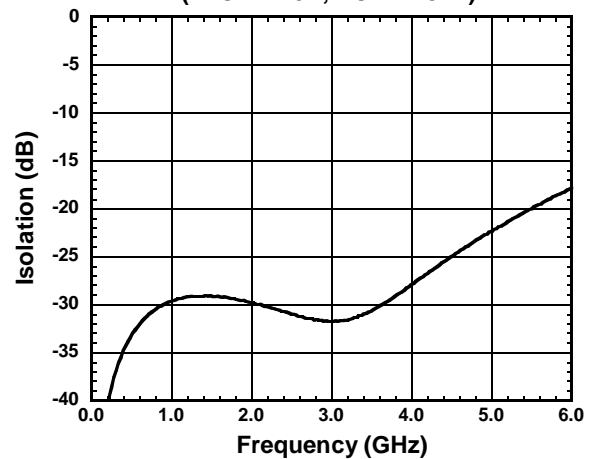

ELECTRICAL CHARACTERISTICS

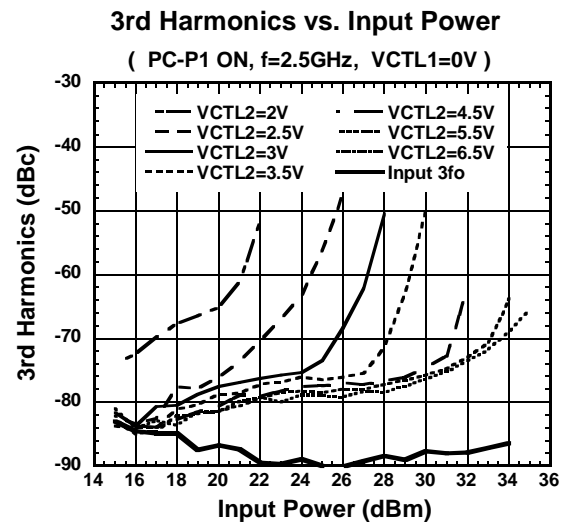
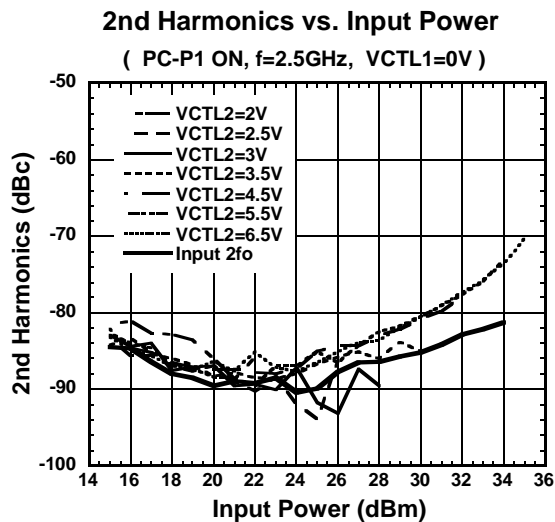
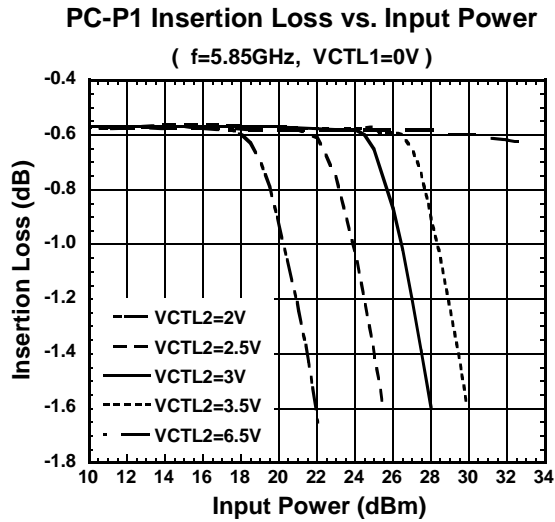
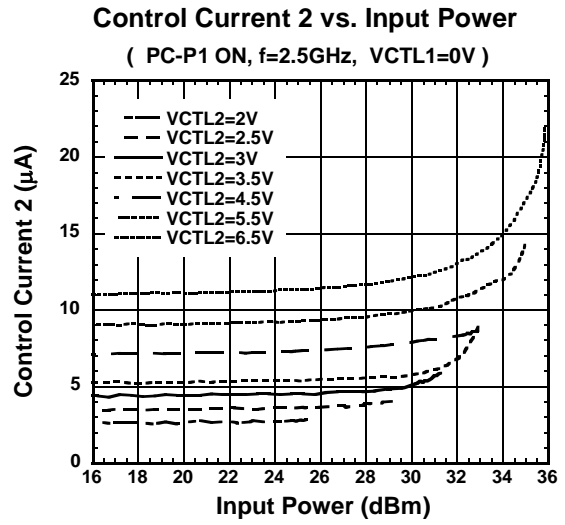
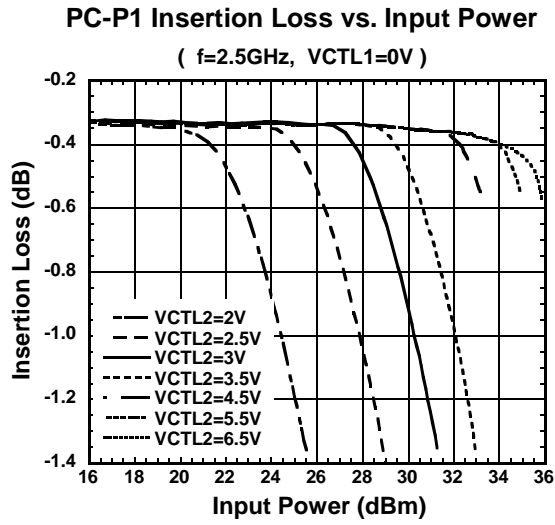

NJG1608KB2

ELECTRICAL CHARACTERISTICS

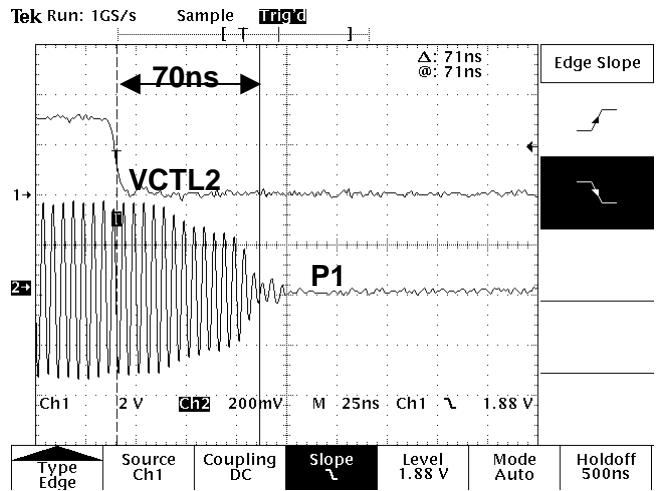
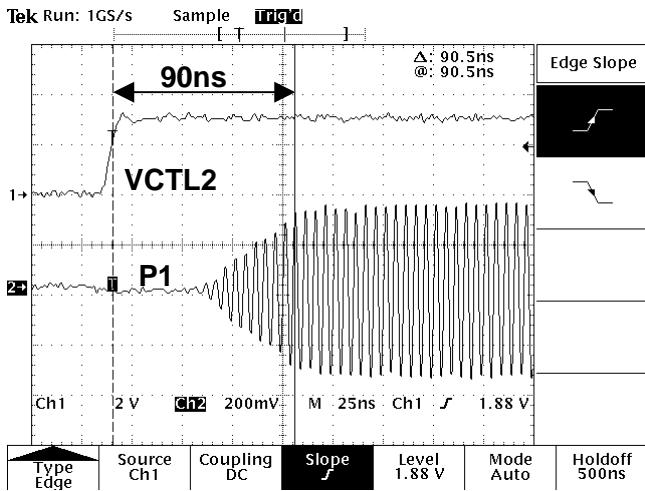

APPLICATION CIRCUIT

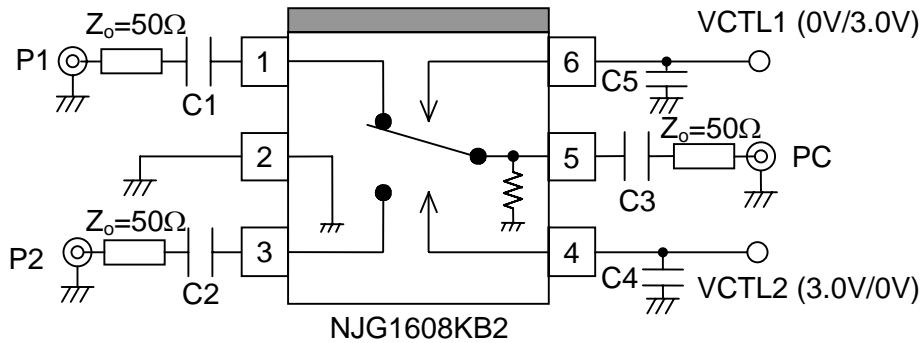

Parts List

Parts number	List 1	List 2	List 3	Notes
	100~500MHz	0.5~2.0GHz	2.0~6.0GHz	
C1~C3	1000pF	56pF	16pF	GRM15 MURATA
C4, C5	10pF	10pF	10pF	GRM15 MURATA

RECOMMENDED PCB DESIGN

(TOP VIEW)

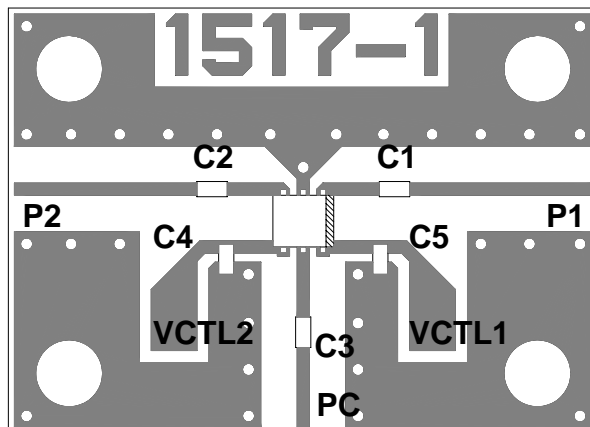

PCB SIZE=19.4x14.0mm
 PCB: FR-4, t=0.2mm
 CAPACITOR: size 1005
 STRIPLINE WIDTH=0.4mm

PRECAUTIONS

- [1] The DC blocking capacitors have to be placed at RF terminal of P1, P2 and PC.
Please choose appropriate capacitance values to the application frequency.
- [2] To reduce stripline influence on RF characteristics, please locate bypass capacitors (C4, C5) close to each terminals.
- [3] For good isolation, the GND terminal (2nd pin) must be placed possibly close to ground plane of substrate, and through holes for GND should be placed near by the pin connection.

NJG1608KB2

PACKAGE OUTLINE (FLP6-B2)

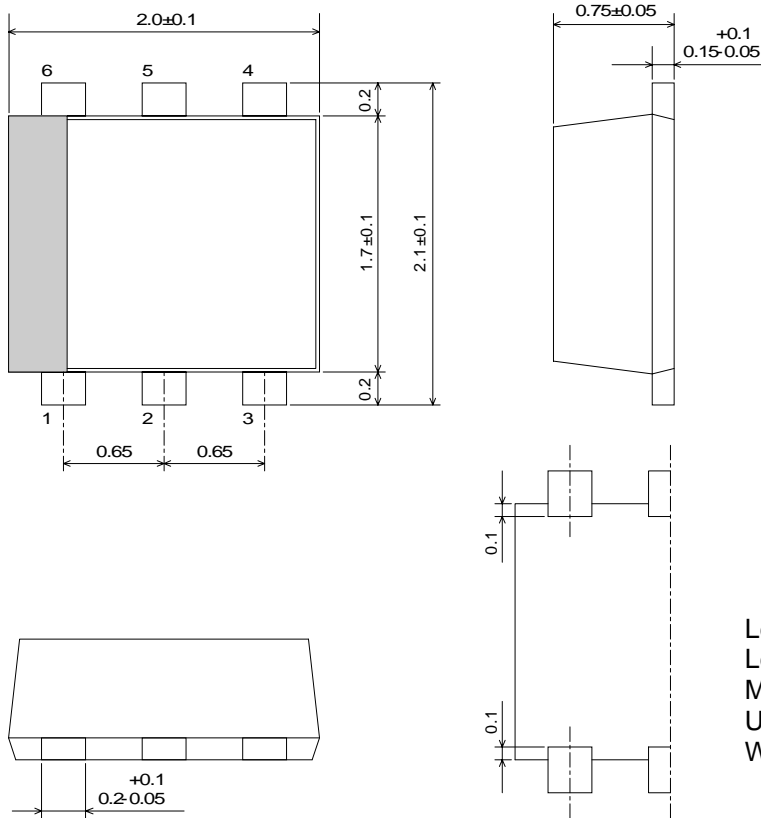

Lead material : Copper
 Lead surface finish : Solder plating
 Molding material : Epoxy resin
 UNIT : mm
 Weight : 6.5mg

Cautions on using this product

This product contains Gallium-Arsenide (GaAs) which is a harmful material.

- Do NOT eat or put into mouth.
- Do NOT dispose in fire or break up this product.
- Do NOT chemically make gas or powder with this product.
- To waste this product, please obey the relating law of your country.

[CAUTION]

The specifications on this databook are only given for information, without any guarantee as regards either mistakes or omissions. The application circuits in this databook are described only to show representative usages of the product and not intended for the guarantee or permission of any right including the industrial rights.

This product may be damaged with electric static discharge (ESD) or spike voltage. Please handle with care to avoid these damages.