

Panasonic
ideas for life

onlinecomponents.com

THE ONLINE DISTRIBUTOR OF ELECTRONIC COMPONENTS

NARROW-PITCH CONNECTORS FOR BOARD-TO-BOARD CONNECTION

NARROW PITCH (0.5mm) CONNECTORS P5 SERIES — P5KL —



Socket



Header



FEATURES

1. Low profile mating height of 1.2 mm with 0.5 mm pitch, was obtained. It contributes to device compactness.

2. Strong resistance to adverse environments! Utilizes **TOUGH CONTACT** construction for high contact reliability.

1) Contacts are highly resistant to shock caused by dropping and employ our original bellows contact construction.

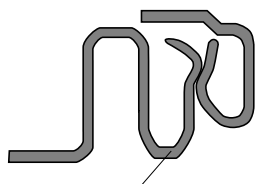

Since the contact is formed by bending thin plate, it has a spring-like quality. This structure makes it resistant to dropping and twisting.

2) V notch construction used for excellent resistance against foreign matters.

● What is V notch construction?

By using the edge for the contacting part and increasing contact pressure per unit area, the effectiveness in removing flux and contaminants is increased compared to its predecessor. This is also effective in preventing the trapping of contaminants.

[Cross section of contacting part]

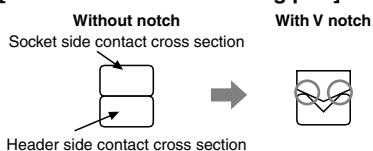

3) Use of Ni barrier construction is standard. Highly effective against solder creeping. (Available from Nov. 2005)

● What is Ni barrier construction?

By providing an exposed nickel part on the gold (Au) plated contact, solder creeping is prevented despite the ultra low profile.

[Contact]

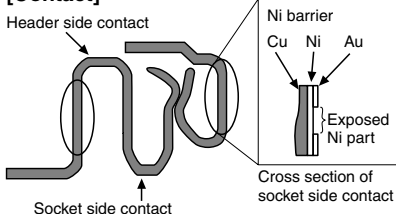

4) Porosity treatment applied for improved resistance against corrosion.

What is porosity treatment?

This treatment consists of coating the surface with a very thin film to seal pinholes in the gold plating. This porosity treatment technology ensures the same contact reliability for thin gold plating as that of thick gold plating.

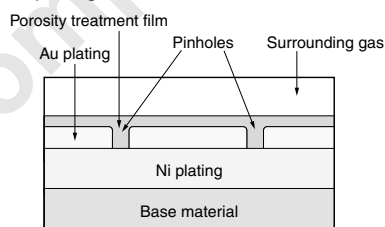

- Improvement in insertion/removal durability
- Improvement in resistance to corrosion
- Improvement in contact reliability for digital signals

3. Simple lock structure employed to further increase connection reliability

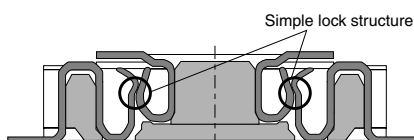

4. Effective mating length 0.3 mm

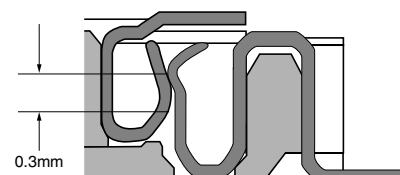

5. Compliance with RoHS' Directive
Environmentally friendly, the connectors' comply with Europe's RoHS' Directive. Cadmium, lead, mercury, hexavalent, chromium, PBB and PBDE are not used.

APPLICATIONS

- Cellular phones
- PHS
- Portable data terminals
- Digital cameras
- Compact portable devices

Ideal for Board-to-FPC connections

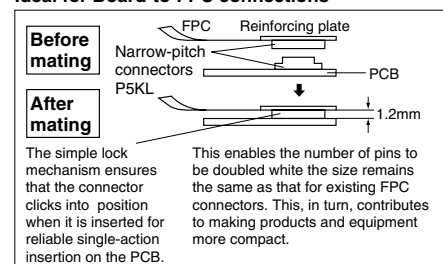

AXK(5/6)L

TABLE OF PRODUCT TYPES

P5KL (0.5 mm pitch): Without retention fitting



Socket



Header

☆: Available for sale

Mated height	1.2mm	
	10	☆
Number of contacts	12	☆
	20	☆
	24	☆
	30	☆
	34	☆
	40	☆
	50	☆
	60	☆

- Notes: 1. The standard type comes with positioning bosses.
Connectors with positioning boss are available for on-demand production.
2. Please consult us regarding numbers of contacts other than those given above.

ORDERING INFORMATION

AXK

5L: Narrow Pitch Connector P5KL (0.5 mm pitch) Socket
6L: Narrow Pitch Connector P5KL (0.5 mm pitch) Header

Number of contacts (2 digits)

Mated height

<Socket>

3: For mated height 1.2 mm

<Header>

3: For mated height 1.2 mm

Functions

3: With positioning bosses

4: Without positioning bosses

Surface treatment (Contact portion / Terminal portion)

5: Ni plating on base, Au plating on surface

7: Ni plating on base, Au plating on surface (for Ni barrier product available from Nov. 2005)

Packing ^{Note)}

G: 3,000 pieces embossed tape and plastic reel × 2 (for Ni barrier product available from Nov. 2005)

J: 3,000 pieces embossed tape and paper reel × 2

V: 3,000 pieces embossed tape and paper reel × 5

Note) For packaging, models without Ni barrier only support "J" and "V". Models with Ni barrier support only "G".

PRODUCT TYPES

Mated height	No. of contacts	Part No.				Packing quantity	
		Socket		Header		Inner carton (1-reel)	Outer carton
		Ni barrier product: Not available (Paper reel)	TOUGH CONTACT (Plastic reel) (Recommendation)	Ni barrier product: Not available (Paper reel)	TOUGH CONTACT (Plastic reel) (Recommendation)		
1.2 mm	10	AXK5L10345*	AXK5L10347G (From Nov. 2005)	AXK6L10345*	AXK6L10347G (From Nov. 2005)	Asterisk "*" mark on end of part No.; J: 3,000 pieces V: 3,000 pieces "G" mark on end of part No.; 3,000 pieces	Asterisk "*" mark on end of part No.; J: 6,000 pieces (2-reel) V: 15,000 pieces (5-reel) "G" mark on end of part No.; 6,000 pieces (2-reel)
	12	AXK5L12345*	AXK5L12347G (From Nov. 2005)	AXK6L12345*	AXK6L12347G (From Nov. 2005)		
	20	AXK5L20345*	AXK5L20347G (From Nov. 2005)	AXK6L20345*	AXK6L20347G (From Nov. 2005)		
	24	AXK5L24345*	AXK5L24347G (From Nov. 2005)	AXK6L24345*	AXK6L24347G (From Nov. 2005)		
	30	AXK5L30345*	AXK5L30347G (From Nov. 2005)	AXK6L30345*	AXK6L30347G (From Nov. 2005)		
	34	AXK5L34345*	AXK5L34347G (From Nov. 2005)	AXK6L34345*	AXK6L34347G (From Nov. 2005)		
	40	AXK5L40345*	AXK5L40347G (From Nov. 2005)	AXK6L40345*	AXK6L40347G (From Nov. 2005)		
	50	AXK5L50345*	AXK5L50347G (From Nov. 2005)	AXK6L50345*	AXK6L50347G (From Nov. 2005)		
	60	AXK5L60345*	AXK5L60347G (From Nov. 2005)	AXK6L60345*	AXK6L60347G (From Nov. 2005)		

Notes) 1. Regarding ordering units: During production, Please make orders in 1-reel units. Samples for mounting confirmation: Please consult us. Samples: Small lot orders are possible. Please consult us.

2. The standard type comes without positioning bosses. Connectors with positioning bosses are available for on-demand production.
For this type of connector, 9th digit of the part no. changes from 4 to 3. e.g. 10 contacts for sockets: AXK5L10337G

SPECIFICATIONS

1. Characteristics

	Item	Specifications	Conditions
Electrical characteristics	Rated current	0.5A/contact (Max. 10 A at total contacts)	
	Rated voltage	60V AC/DC	
	Breakdown voltage	150V AC for 1 minute	Detection current: 1mA
	Insulation resistance	Min. 1,000M Ω (initial)	Using 500V DC megger
	Contact resistance	Max. 90m Ω	Measured based on the HP4338B measurement method of JIS C 5402
Mechanical characteristics	Composite insertion force	Max. 0.981N {100gf}/contacts \times contacts (initial)	
	Composite removal force	Min. 0.0588N {6gf}/contacts \times contacts	
	Holding force of terminal securing section	Min. 0.981N {100gf}/contact	Measures the maximum load in the post axial direction until removal
Environmental characteristics	Ambient temperature	-55°C to +85°C	No freezing at low temperatures
	Soldering heat resistance	Max. peak temperature of 245°C	Infrared reflow soldering
		300°C within 5 seconds 350°C within 3 seconds	Soldering iron
	Thermal shock resistance (header and socket mated)	5 cycles, insulation resistance min. 100M Ω , contact resistance max. 90m Ω	Sequence 1. -55 \pm 3°C, 30 minutes 2. ~, Max. 5 minutes 3. 85 \pm 3°C, 30 minutes 4. ~, Max. 5 minutes
	Humidity resistance (header and socket mated)	120 hours, insulation resistance min. 100M Ω , contact resistance max. 90m Ω	Bath temperature 40 \pm 2°C, humidity 90 to 95% R.H.
	Saltwater spray resistance (header and socket mated)	24 hours, insulation resistance min. 100M Ω , contact resistance max. 90m Ω	Bath temperature 35 \pm 2°C, saltwater concentration 5 \pm 1%
	H ₂ S resistance (header and socket mated)	48 hours, contact resistance max. 90m Ω	Bath temperature 40 \pm 2°C, gas concentration 3 \pm 1 ppm, humidity 75 to 80% R.H.
Lifetime characteristics	Insertion and removal life	50 times	Repeated insertion and removal speed of max. 200 times/hours
Unit weight		20 contacts; Socket: 0.05g; Header: 0.02g	

2. Material and surface treatment

Part name	Material	Surface treatment
Molded portion	Heat-resistant resin (UL94V-0), Ivory white	—
Contact/Post	Copper alloy	Contact portion: Ni plating on base, Au plating on surface Terminal portion: Ni plating on base, Au plating on surface (Except for thick of terminal) However, the area adjacent to the terminal on Ni barrier models is exposed to Ni on base.

AXK(5/6)L

DIMENSIONS

- Socket (Mated height: 1.2mm)

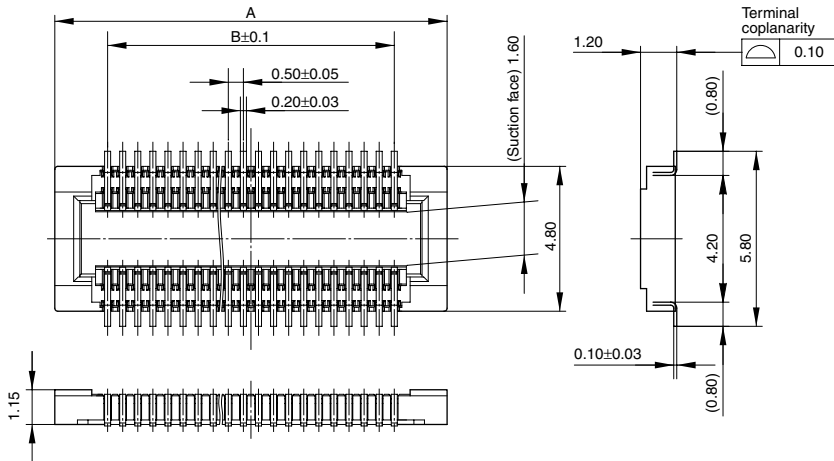

Dimension table (mm)

No. of contacts	A	B
10	5.50	2.00
12	6.00	2.50
20	8.00	4.50
24	9.00	5.50
30	10.50	7.00
34	11.50	8.00
40	13.00	9.50
50	15.50	12.00
60	18.00	14.50

- Header (Mated height: 1.2mm)

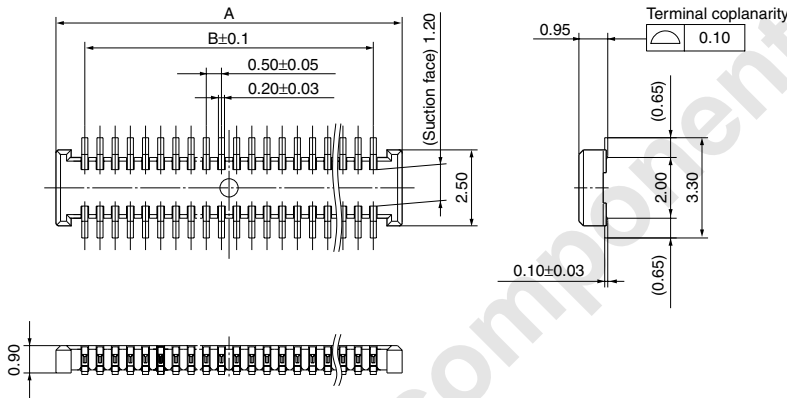

Dimension table (mm)

No. of contacts	A	B
10	3.90	2.00
12	4.40	2.50
20	6.40	4.50
24	7.40	5.50
30	8.90	7.00
34	9.90	8.00
40	11.40	9.50
50	13.90	12.00
60	16.40	14.50

- Socket and header are mated

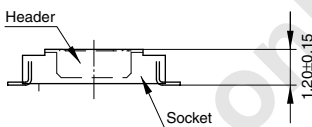

EMBOSSED TAPE DIMENSIONS (unit:mm, Common for respective contact type, socket and header)

• Tape dimensions (Conforming to JIS C 0806-1990.
However, some tapes have mounting hole pitches that do not comply with the standard.)

• Plastic reel dimensions (Conforming to EIAJ ET-7200B)/
Paper reel dimensions (Conforming to JIS C 0806-1990)

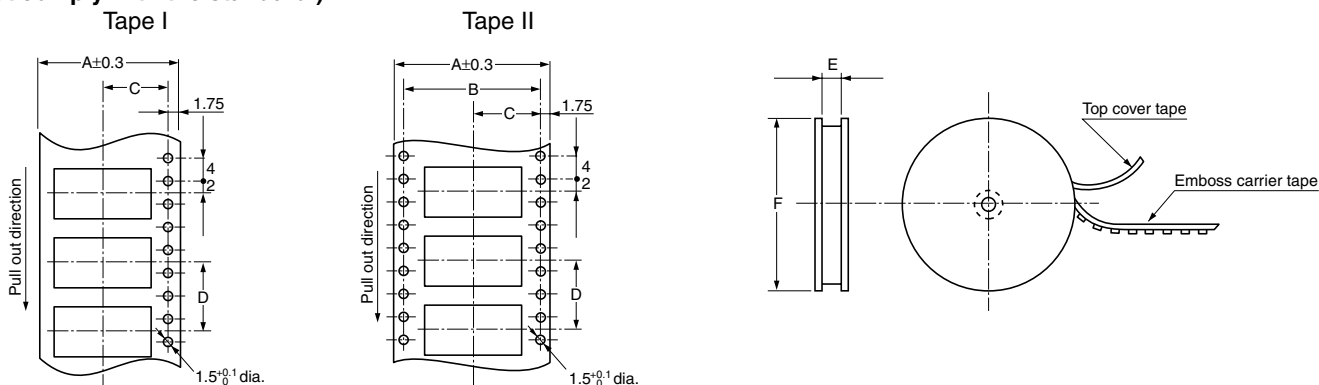

Dimension table (mm)

(1) Suffix: G (1 reel, 3,000 pieces embossed tape: Plastic reel package) ... From Nov. 2005

Mated height	No. of contacts	Type of taping	A	B	C	D	E	F	Quantity per reel
Socket and header are common: 1.2mm	10 to 18	Tape I	16.0	—	7.5	8.0	17.4±1	380 dia.	3,000 pcs.
	20 to 50	Tape I	24.0	—	11.5	8.0	25.4±1	380 dia.	3,000 pcs.
	60	Tape II	32.0	28.4	14.2	8.0	33.4±1	380 dia.	3,000 pcs.

(2) Suffix: J, V (1 reel, 3,000 pieces embossed tape: Paper reel package)

Mated height	No. of contacts	Type of taping	A	B	C	D	E	F	Quantity per reel
Socket and header are common: 1.2mm	10 to 18	Tape I	16.0	—	7.5	8.0	16.4 ⁺² ₀	370 dia.	3,000 pcs.
	20 to 50	Tape I	24.0	—	11.5	8.0	24.4 ⁺² ₀	370 dia.	3,000 pcs.
	60	Tape II	32.0	28.4	14.2	8.0	32.4 ⁺² ₀	370 dia.	3,000 pcs.

Connector orientation with respect to direction of progress of embossed tape

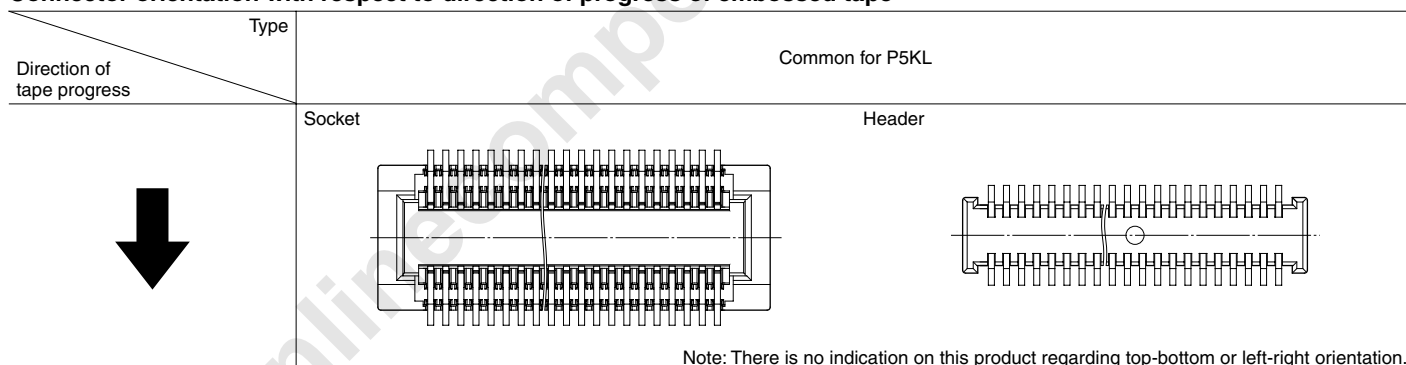

NOTES

1. As shown below, excess force during insertion may result in damage to the connector or removal of the solder. Please be careful. Also, to prevent connector damage please confirm the correct position before mating connectors.

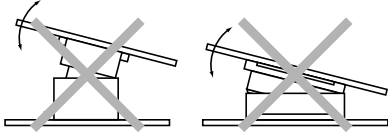

2. Keep the PC board warp no more than 0.03 mm in relation to the overall length of the connector.

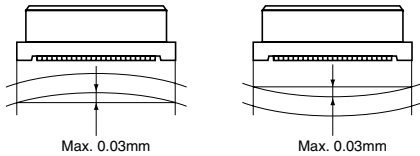

3. PC Boards and Recommended Metal Mask Patterns

Connectors are mounted with high density, with a pitch interval of 0.4 to 0.5 mm. It is therefore necessary to make sure that the right levels of solder are used, in order to reduce solder bridge and other issues. The figures to the right are recommended metal mask patterns. Please use them as a reference.

• Socket

Recommended PC board pattern (TOP VIEW)

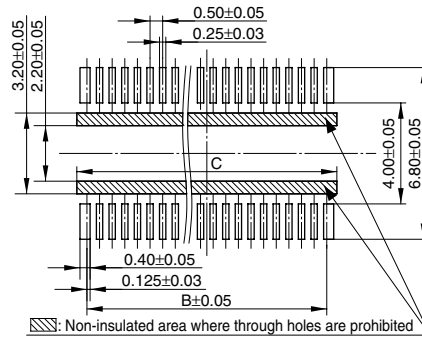

Recommended metal mask pattern

Metal mask thickness: 150 μm
(Terminal portion opening area ratio: 57%)

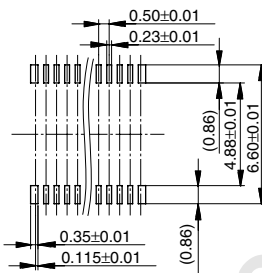

Recommended metal mask pattern

Metal mask thickness: 120 μm
(Terminal portion opening area ratio: 70%)

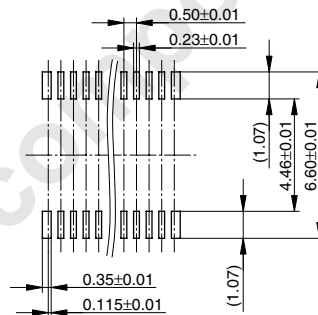

• Header

Recommended PC board pattern (TOP VIEW)

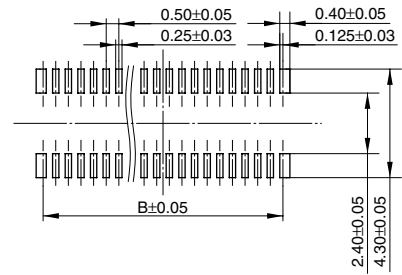

Recommended metal mask pattern

Metal mask thickness: 150 μm
(Terminal portion opening area ratio: 56%)

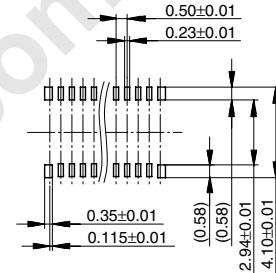

Recommended metal mask pattern

Metal mask thickness: 120 μm
(Terminal portion opening area ratio: 70%)

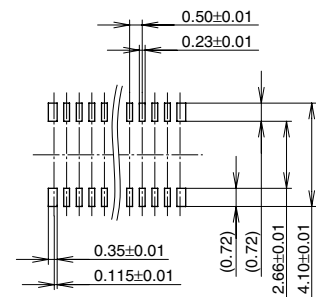

Regarding general notes, please refer to page 12.

For other details, please verify with the product specification sheets.