

Amphenol® ACA-B Reverse Bayonet Coupling Connectors

12-027-1



**The Industrial Connector for Factory Automation, Robotics,
Process Control and Test & Measurement Equipment.**

Amphenol

Table of Contents	Page No.
Amphenol® ACA-B Reverse Bayonet Coupling Connectors	
General Description	1
Insert availability	2-4
Insert alternate positioning	5
Contact arrangements.	6-24
ACA-B Connector Classes	25
ACA 3100F-B wall mount receptacle for front panel mounting	26
ACA 3100E-B wall mount receptacle for front panel mounting	27
ACA 3100G-B wall mount receptacle for front panel mounting	28
ACA 3100R-B wall mount receptacle for front panel mounting	29
ACA 3101F-B cable connecting receptacle	30
ACA 3101E-B cable connecting receptacle	31
ACA 3101G-B cable connecting receptacle	32
ACA 3101R-B cable connecting receptacle	33
ACA 3102E-B box mount receptacle for front panel mounting	34
ACA 3103F-B wall mount receptacle for rear panel mounting	35
ACA 3103E-B wall mount receptacle for rear panel mounting	36
ACA 3103G-B wall mount receptacle for rear panel mounting	37
ACA 3103R-B wall mount receptacle for rear panel mounting	38
ACA 3106F-B straight plug	39
ACA 3106E-B straight plug	40
ACA 3106G-B straight plug	41
ACA 3106R-B straight plug	42
ACA 3107A-B jam nut receptacle.	43
ACA 3108F-B 90 degree angle plug	44
ACA 3108E-B 90 degree angle plug	45
Connector Accessories - sealing gaskets	46
Connector Accessories - receptacle protection caps	47
Accessories - plug protection caps	48
Accessories - rear mounting data - receptacles, sealing plugs, sealing ranges.	49
Accessories - crimp and solder contact information.	50-52
ACA-B Connectors How to Order, connector intermateability.	53
Sales office listing	

For further information on your individual application requirements, contact:

Amphenol Corporation
Amphenol Industrial Operations
40-60 Delaware Avenue
Sidney, New York 13838-1395

Phone: 607-563-5011 Fax: 607-563-5351

View and download or print Amphenol catalogs on-line at: www.amphenol-industrial.com

Amphenol Aerospace is a Certified ISO 9001 Manufacturer

Amphenol® ACA-B Connectors

with reverse bayonet coupling



Features of the Amphenol® ACA-B Reverse Bayonet Coupling Connectors with MIL-DTL-5015 insert patterns:

- Quick positive coupling
- Audible and tactile indication of full coupling
- Waterproof - IP67 rated
- No lockwiring required
- High shock and vibration capabilities
- Inserts available in Neoprene
- Available in both crimp and solder terminations
- Contacts available in gold and silver plating
- Numerous finishes available
- Zinc alloy plating (cadmium free) available
- Rugged construction
- Intermateable with existing VG95234 connectors
- 500 couplings minimum
- Up to 50% more ampacity with the use of RADSOK® socket contacts. Consult Amphenol Industrial Operations for more information or see Amphenol® Amphe-Power Connectors with RADSOK® Technology, SL-391 (online at www.amphenol-industrial.com).
- Operating temperature range: -55°C to 125°C

RoHS Compliant Product Available – Consult Amphenol Industrial Operations.



The ACA-B is designed for commercial and Industrial environments requiring a rugged bayonet style connector for heavy duty power and signal applications.

A comprehensive selection of insert arrangements and accessory hardware configurations are featured to accommodate heavy-duty, commercial wire and cable.

ACA-B is manufactured in accordance with MIL-DTL-5015 and VG95234. The insulators are made of high quality polychloroprene material and can withstand temperatures of -55 to +125 degrees C. The rugged shell is made from aluminum alloy and plated with a variety of finishes to meet any application. Contacts are machined from copper alloy or brass and can be plated with gold or silver.

Common applications include automation, machine tool, robotics, instrumentation, process control, material handling, and test and measurement.



ACA-B

insert availability

Insert Arrangement	Service Rating	Total Contacts	Contact Size											
			0	4	8	12	16	Coax						
								0	4	8	12			
10SL-3	A	3					3							
10SL-4†	A	2					2							
14S-2	Inst.	4					4							
14S-4	D	1					1							
14S-5	Inst.	5					5							
14S-6	Inst.	6					6							
14S-7	A	3					3							
14S-9	A	2					2							
14S-10	Inst.	4					4							
14S-12	A	3					3							
14S-A7	A	7					7							
16S-1	A	7					7							
16S-3	B	1					1							
16S-4	D	2					2							
16S-5	A	3					3							
16S-6	A	3					3							
16S-8	A	5					5							
16-2	E	1				1								
16-7	A	3			1		2							
16-9	A	4				2	2							
16-10	A	3				3								
16-11	A	2				2								
16-12	A	1		1										
16-13	A	2				2								
16-59	A	4				4								
18-1	A/Inst.	10					10							
18-3	D	2				2								
18-4	D	4					4							
18-5	D	3				2	1							
18-6	D	1		1										
18-7	B	1			1									
18-8	A	8				1	7							
18-9	Inst.	7				2	5							
18-10	A	4				4								
18-11	A	5				5								
18-12	A	6					6							
18-13	A	4			1	3								
18-14	A	2		1			1							
18-15	A	4				4								
18-17	Inst.	7				2	5							
18-19	A	10					10							
18-20	A	5					5							
18-22	D	3					3							
18-24	A/Inst.	10					10							
18-29	A	5					5							
18-30	A	5					5							
18-31	A	5					5							

Crimp contacts accommodate wire the same size as the contact as well as wire of the next smaller, even size. Arrangements identified with an asterisk () are exceptions. See insert arrangement drawings on pages 6-24 for application wire size.

Insert Arrangement	Service Rating	Total Contacts	Contact Size											
			0	4	8	12	16	Coax						
								0	4	8	12			
20-2	D	1	1											
20-3	D	3				3								
20-4	D	4				4								
20-6	D	3					3							
20-7	D/A	8					8							
20-8	Inst.	6			2		4							
20-9	D/A	8				1	7							
20-11	Inst.	13					13							
20-12	A	2		1			1							
20-14	A	5			2	3								
20-15	A	7				7								
20-16	A	9				2	7							
20-17	A	6				5	1							
20-18	A	9				3	6							
20-19	A	3			3									
20-20	A	4		1		3								
20-21	A	9				1	8							
20-22	A	6			3		3							
20-23	A	2			2									
20-24	A	4			2		2							
20-25	Inst.	13					13							
20-26	A	19					19							
20-27	A	14					14							
20-29	A	17					17							
20-30	Inst.	13					13							
20-33	A	11					11							
20-51	A	3			3									
20-57	A	7				7*								
20-58	A	10				5	5							
20-59	A	3			3*									
20-66	A	6				5*	1							
20-79	A/D	8				1	7							
22-1	D	2			2									
22-2	D	3			3									
22-4	A	4			2	2								
22-5	D	6				2	4							
22-6	D	3			2		1							
22-7	E	1	1											
22-8	E	2				2								
22-9	E	3				3								
22-10	E	4					4							
22-11	B	2					2							
22-12	D	5			2		3							
22-13	D/A	5				4	1							
22-14	A	19					19							
22-15	E/A	6				5	1							

†10SL-4 arrangement available only with pin contacts in receptacle and socket contacts in plug

**Coaxial cable data can be found on insert arrangement drawings, pages 6-24. For further information on coaxial contacts and cable see catalog 12-130.

ACA-B

insert availability, cont.

Insert Arrangement	Service Rating	Total Contacts	Contact Size											
			0	4	8	12	16	Coax**						
								0	4	8	12			
22-16	A	9				3	6							
22-17	D/A	9				1	8							
22-18	D/A	8					8							
22-19	A	14					14							
22-20	A	9					9							
22-21	A	3	1				2							
22-22	A	4			4									
22-23	D/A	8				8								
22-24	D/A	6				2	4							
22-27	D/A	9			1		8							
22-28	A	7				7								
22-33	D/A	7					7							
22-34	D	5				3	2							
22-63	A	12				4	8							
22-65	D/A	8				8*								
22-70	A	13				8	5							
22-80	A	3			3*									
24-2	D	7				7								
24-3	D	7				2	5							
24-5	A	16					16							
24-6	D/A	8				8								
24-7	A	16				2	14							
24-9	A	2		2										
24-10	A	7			7									
24-11	A	9			3	6								
24-12	A	5		2		3								
24-16	D/A	7			1	3	3							
24-17	D	5				2	3							
24-19	A	12					12							
24-20	D	11				2	9							
24-21	D	10			1		9							
24-22	D	4			4									
24-27	E	7					7							
24-28	Inst.	24					24							
24-51	A	5			5									
24-52	Hi Volt.	1				1								
24-53	A	5			5									
24-58	A	13			3	3	7							
24-59	A	14				7	7							
24-60	A	7			7*									
24-65	A	15				11	4							
24-66	D	7				7								
24-67	Inst.	19				19								
24-71	A	7			7*									
24-75	A	7			7*									
24-79	A	5			5									
24-80	Inst.	23					23							

Crimp contacts accommodate wire the same size as the contact as well as wire of the next smaller, even size. Arrangements identified with an asterisk () are exceptions. See insert arrangement drawings on pages 6-24 for application wire size.

Insert Arrangement	Service Rating	Total Contacts	Contact Size											
			0	4	8	12	16	Coax**						
								0	4	8	12			
24-84	A	19				1							18	
24-96	Inst.	28					28							
24-AJ	A	25					25							
28-1	D/A	9			3	6								
28-2	D	14				2	12							
28-3	E	3			3									
28-4	E/D	9				2	7							
28-5	D	5		2		1	2							
28-6	D	3		3										
28-7	D	2		2										
28-8	E/D/A	12				2	10							
28-9	D	12				6	6							
28-10	D/A	7		2	2	3								
28-11	A	22				4	18							
28-12	A	26					26							
28-13	A	26					26							
28-15	A	35					35							
28-16	A	20					20							
28-17	B/D/A	15					15							
28-18	C/D/A/Inst.	12					12							
28-19	B/D/A	10				4	6							
28-20	A	14				10	4							
28-21	A	37					37							
28-22	D	6		3			3							
28-51	A	12				12								
28-59	A	17				7	10							
28-66	A	16			2	14								
28-72	Coax	3									3			
28-74	A	16			7*		9							
28-75	A	16			7*		9							
28-79	A	16			7		9							
28-82	D	6			2	4								
28-84	A	9			9									
28-AY	A	9		4			5							
32-1	E/D	5	2			3								
32-2	E	5		3			2							
32-3	D	9	1	2		2	4							
32-4	A/D	14				2	12							
32-5	D	2	2											
32-6	A	23		2	3	2	16							
32-7	Inst./A	35				7	28							
32-8	A	30				6	24							
32-9	D	14		2			12							
32-10	E/B/D/A	7		2	2		3							
32-12	A/D	15				5	10							
32-13	D	23				5	18							

**Coaxial cable data can be found on insert arrangement drawings, pages 6-24. For further information on coaxial contacts and cable see catalog 12-130.

ACA-B

insert availability, cont.

Insert Arrangement	Service Rating	Total Contacts	Contact Size											
			0	4	8	12	16	Coax**						
								0	4	8	12			
32-15	D	8	2			6								
32-16	A	23		2	3	2	16							
32-17	D	4		4										
32-22	A	54					54							
32-25	A	25				25								
32-31	A	31					31							
32-48	Inst.	48					48							
32-52	D	8	2			6								
32-53	E/Inst.	42				5	37							
32-56	A	30				6*	24							
32-57	Coax	8				6		2						
32-58	Coax	4							4					
32-59	A	42					40			2				
32-60	A	23					15			8				
32-62	Coax	23		2	1	2	16			2				
32-64	Inst.	54					54							
32-68	A	16					12	4						
32-73	A	46					46							
32-75	Coax	9				2				7				
32-76	A	19				19								
32-79	D	5		4	1									
32-82	A	16		4			12							
32-AF	A	55					55							
32-AM	A	1	1 size 4/0											
36-1	D	22				4	18							
36-3	D	6	3			3								
36-4	D/A	3	3											
36-5	A	4	4											
36-6	A	6	2	4										
36-7	A	47				7	40							
36-8	A	47				1	46							
36-9	A	31		1	2	14	14							
36-10	A	48					48							

Crimp contacts accommodate wire the same size as the contact as well as wire of the next smaller, even size. Arrangements identified with an asterisk () are exceptions. See insert arrangement drawings on pages 6-24 for application wire size.

Insert Arrangement	Service Rating	Total Contacts	Contact Size											
			0	4	8	12	16	Coax**						
								0	4	8	12			
36-11	A	48					48							
36-12	A	48					48							
36-13	E/A	17				2	15							
36-14	D	16			5	5	6							
36-15	D/A	35					35							
36-16	A	47				7	40							
36-17	A	47				7	40							
36-18	A	31		1	2	14	14							
36-20	A	34			2	2	30							
36-22	D	22				22								
36-51	D	4	2	2										
36-52	A	52					52							
36-54	A	39			8		31							
36-55	A	39			8*		31							
36-59	A	53				3*	50							
36-60	A	47				7*	40							
36-64	Coax	4								4				
36-65	Coax	4								4				
36-71	A	53				3	50							
36-73	Coax	7								7				
36-74	A	44					43				1			
36-75	A	48					48*							
36-76	A	47					47							
36-77	D	7		7										
36-78	A	14			12		2							
36-79	A	20				20								
36-80	A	20				20*								
36-83	Coax	7								7				
36-85	A/D	35					35*							
36-97	C	1	1 size 4/0											
36-99	D	12		3	3	3	3							
36-AF	A	48					48							

**Coaxial cable data can be found on insert arrangement drawings, pages 6-24. For further information on coaxial contacts and cable see catalog 12-130.

ACA-B

insert alternate positioning

To avoid cross-plugging problems in applications requiring the use of more than one connector of the same size and arrangement, alternate rotations are available as indicated in the accompanying charts.

As shown in the diagram below, the front face of the pin insert is rotated within the shell in a clockwise direction from the normal shell key. The socket insert would be rotated counter-clockwise the same number of degrees in respect to the normal shell key.

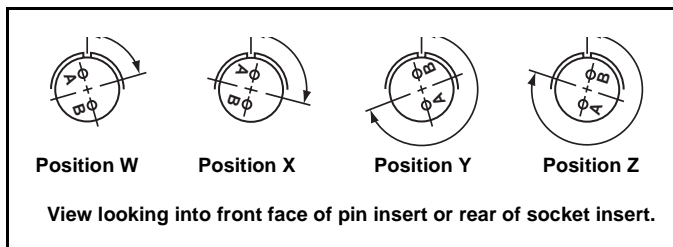

The following insert arrangements have the same alternate insert rotations for W, X, Y and Z, which are:

Degrees			
W	X	Y	Z
80	110	250	280

16-7	20-16	22-18	24-4	24-28	28-16	32-10
18-5	20-20	22-19	24-5	24-AJ	28-17	32-12
18-9	20-22	22-21	24-6	28-1	28-19	32-13
18-13	22-3	22-24	24-7	28-4	28-20	32-22
18-14	22-6	22-25	24-12	28-8	28-21	32-AF
20-7	22-12	22-29	24-14	28-9	32-1	36-1
20-8	22-14	22-33	24-16	28-10	32-3	36-7
20-9	22-15	22-34	24-17	28-11	32-4	36-8
20-12	22-16	24-1	24-20	28-14	32-6	36-13
20-14	22-17	24-3	24-21	28-15	32-9	

Insert Arrangement	Degrees			
	W	X	Y	Z
10SL-4	63	-	-	-
14S-2	-	120	240	-
14S-5	-	110	-	-
14S-7	90	180	270	-
14S-9	70	145	215	290
16-9	35	110	250	325
16-10	90	180	270	-
16-11	35	110	250	325
16-13	35	110	250	325
16S-1	80	-	-	280
16S-4	35	110	250	325
16S-5	70	145	215	290
16S-6	90	180	270	-
16S-8	-	170	265	-
18-1	70	145	215	290
18-3	35	110	250	325
18-4	35	110	250	325
18-8	70	-	-	290
18-10	-	120	240	-
18-11	-	170	265	-
18-12	80	-	-	280
18-15	-	120	240	-
18-20	90	180	270	-
18-22	70	145	215	290
18-29	90	180	270	-
20-3	70	145	215	290
20-4	45	110	250	-
20-5	35	110	250	325
20-6	70	145	215	290
20-15	80	-	-	280
20-17	90	180	270	-
20-18	35	110	250	325
20-19	90	180	270	-

Insert Arrangement	Degrees			
	W	X	Y	Z
20-21	35	110	250	325
20-23	35	110	250	325
20-24	35	110	250	325
20-27	35	110	250	325
20-29	80	-	-	280
20-33	-	-	-	280
22-1	35	110	250	325
22-2	70	145	215	290
22-4	35	110	250	325
22-5	35	110	250	325
22-8	35	110	250	325
22-9	70	145	215	290
22-10	35	110	250	325
22-11	35	110	250	325
22-13	35	110	250	325
22-20	35	110	250	325
22-22	-	110	250	-
22-23	35	-	250	-
22-27	80	-	250	280
22-28	80	-	-	280
24-2	80	-	-	280
24-9	35	110	250	325
24-10	80	-	-	280
24-11	35	110	250	325
24-22	45	110	250	-
24-27	80	-	-	280
24-96	65	-	-	-
28-2	35	110	250	325
28-3	70	145	215	290
28-5	35	110	250	325
28-6	70	145	215	290
28-7	35	110	250	325

Insert Arrangement	Degrees			
	W	X	Y	Z
28-12	90	180	270	-
28-18	70	145	215	290
28-22	70	145	215	290
28-AY	45	110	250	-
32-2	70	145	215	290
32-5	35	110	250	325
32-7	80	125	235	280
32-8	80	125	235	280
32-15	35	110	250	280
32-17	45	110	250	-
32-25	60	120	-	-
32-64*	80	100	110	250
32-68	30	-	-	-
32-82	30	-	-	-
36-3	70	145	215	290
36-4	70	145	215	290
36-5	-	120	240	-
36-6	35	110	250	325
36-9	80	125	235	280
36-10	80	125	235	280
36-14	90	180	270	-
36-15	60	125	245	305
36-AF	65	-	-	-

*Additional rotations available; consult Amphenol for information.

ACA-B

contact arrangements

front face of pin insert or rear face of socket insert illustrated

Insert Arrangement	10SL-3	10SL-4	14S-2	14S-4	14S-5
Service Rating	A	A	Inst.	D	Inst.
Number of Contacts	3	2	4	1	5
Contact Size	16	16	16	16	16

Insert Arrangement	14S-6	14S-7	14S-9	14S-10	14S-12	14S-A7
Service Rating	Inst.	A	A	Inst.	A	A
Number of Contacts	6	3	2	4	3	7
Contact Size	16	16	16	16	16	16

Insert Arrangement	16S-1	16S-3	16S-4	16S-5	16S-6	16S-8
Service Rating	A	B	D	A	A	A
Number of Contacts	7	1	2	3	3	5
Contact Size	16	16	16	16	16	16

Insert Arrangement	16-2	16-7	16-9
Service Rating	E	A	A
Number of Contacts	1	1 2	2 2
Contact Size	12	8 16	12 16

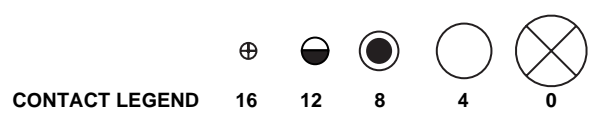

ACA-B

contact arrangements

front face of pin insert or rear face of socket insert illustrated

Insert Arrangement	16-10	16-11	16-12	16-13	16-59
Service Rating	A	A	A	A	A
Number of Contacts	3	2	1	2*	4
Contact Size	12	12	4	12	12

Insert Arrangement	18-1	18-3	18-4	18-5	18-6	18-7
Service Rating	B, C, F, G = A; Bal. = Inst.	D	D	D	D	B
Number of Contacts	10	2	4	2 1	1	1
Contact Size	16	12	16	12 16	4	8

Insert Arrangement	18-8	18-9	18-10	18-11	18-12	18-13
Service Rating	A	Inst.	A	A	A	A
Number of Contacts	1 7	2 5	4	5	6	1 3
Contact Size	12 16	12 16	12	12	16	8 12

Insert Arrangement	18-14	18-15	of 18-9 18-17	18-19	18-20
Service Rating	A	A	Inst.	A	A
Number of Contacts	1 1	4**	2 5	10	5
Contact Size	4 16	12	12 16	16	16



* A = Iron; B = Constantan
 **A, C = Iron; B, D = Constantan

ACA-B

contact arrangements

front face of pin insert or rear face of socket insert illustrated

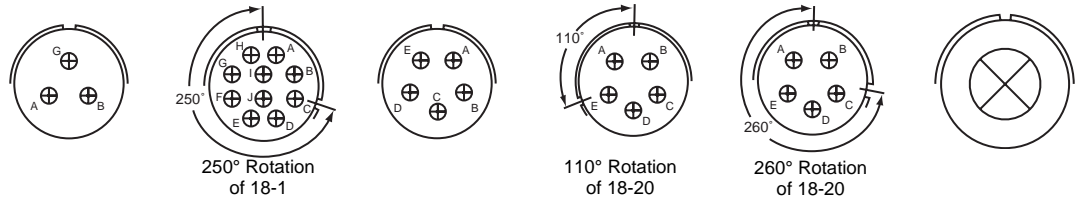

Insert Arrangement	18-22	18-24	18-29	18-30	18-31	20-2
Service Rating	D	B, C, F, G = A; Bal. = Inst.	A	A	A	D
Number of Contacts	3	10	5	5	5	1
Contact Size	16	16	16	16	16	0

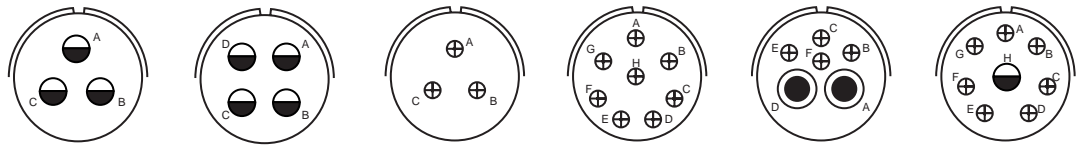

Insert Arrangement	20-3	20-4	20-6	20-7	20-8	20-9
Service Rating	D	D	D	A, B, H, G = D; C, D, E, F = A	Inst.	H = D; Bal. = A
Number of Contacts	3	4	3	8	2 4	1 7
Contact Size	12	12	16	16	8 16	12 16

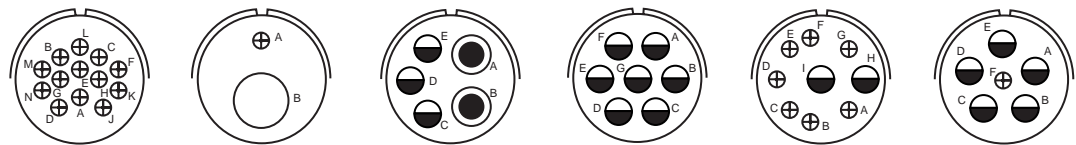

Insert Arrangement	20-11	20-12	20-14	20-15	20-16	20-17
Service Rating	Inst.	A	A	A	A	A
Number of Contacts	13	1 1	2 3	7	2 7	5 1
Contact Size	16	4 16	8 12	12	12 16	12 16



ACA-B

contact arrangements

front face of pin insert or rear face of socket insert illustrated

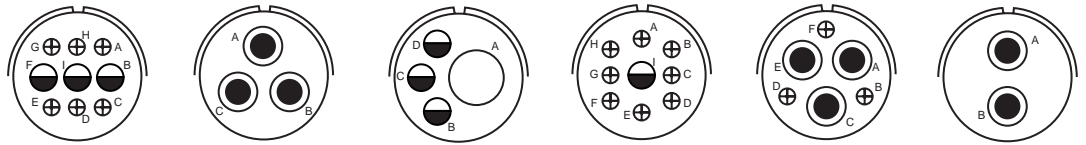

Insert Arrangement	20-18	20-19	20-20	20-21	20-22	20-23
Service Rating	A	A	A	A	A	A
Number of Contacts	3 6	3	1 3	1 8	3 3	2
Contact Size	12 16	8	4 12	12 16	8 16	8

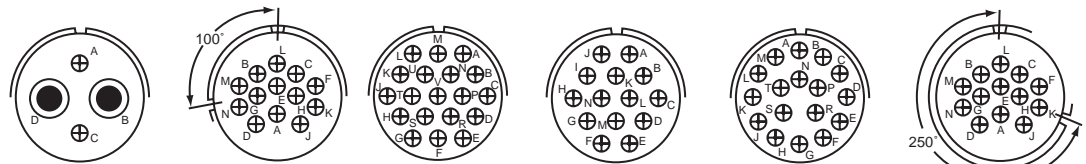

Insert Arrangement	20-24	20-25	20-26	20-27	20-29	20-30
Service Rating	A	Inst.	A	A	A	Inst.
Number of Contacts	2 2	13	19	14	17	13
Contact Size	8 16	16	16	16	16	16

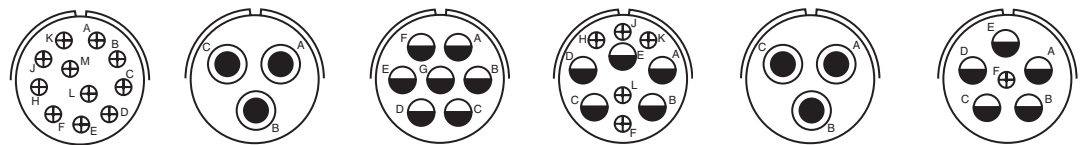

Insert Arrangement	20-33	20-51	20-57	20-58	20-59	20-66
Service Rating	A	A	A	A	A	A
Number of Contacts	11	3*	7*	5 5	3*	1 5
Contact Size	16	8	12 for #14 or 16 wire	12 16	8 for #10 or 12 wire	16 12 for #10 wire

* Solderless



ACA-B

contact arrangements

front face of pin insert or rear face of socket insert illustrated

Insert Arrangement	20-79	22-1	22-2	22-4	22-5
Service Rating	H=D; Bal. = A	D	D	A	D
Number of Contacts	7* 1*	2	3	2 2	2 4
Contact Size	16 12 for #16 wire	8	8	8 12	12 16

Insert Arrangement	22-6	22-7	22-8	22-9	22-10
Service Rating	D	E	E	E	E
Number of Contacts	2 1	1	2	3	4
Contact Size	8 16	0	12	12	16

Insert Arrangement	22-11	22-12	22-13	22-14	22-15
Service Rating	B	D	E = D; A, B, C, D = A	A	D = E; A, B, C, E, F = A
Number of Contacts	2	2 3	4 1	19	5 1
Contact Size	16	8 16	12 16	16	12 16

* Solderless

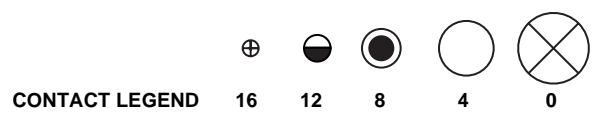

ACA-B

contact arrangements

front face of pin insert or rear face of socket insert illustrated

Insert Arrangement	22-16	22-17	22-18	22-19	22-20
Service Rating	A	A = D; Bal. = A	A, B, F, G, H = D; C, D, E = A	A	A
Number of Contacts	3 6	1 8	8	14	9
Contact Size	12 16	12 16	16	16	16
Insert Arrangement	22-21	22-22	22-23	22-24	22-27
Service Rating	A	A	H = D; Bal. = A	C, D, E = D; A, B, F = A	J = D; Bal. = A
Number of Contacts	1 2	4	8	2 4	1 8
Contact Size	0 16	8	12	12 16	8 16
Insert Arrangement	22-28	22-33	22-34	22-63	22-65
Service Rating	A	A, B, C, D = D; E, F, G = A	D	A	H = D; Bal. = A
Number of Contacts	7	7	3 2	4 8	8*
Contact Size	12	16	12 16	12 16	12 for #14 or 16 wire

* Solderless



ACA-B

contact arrangements

front face of pin insert or rear face of socket insert illustrated

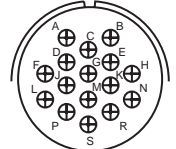
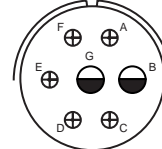
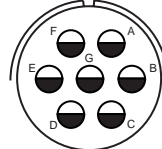
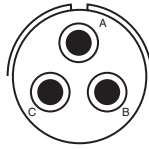
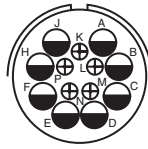

Insert Arrangement	22-70	22-80	24-2	24-3	24-5
Service Rating	A	A	D	D	A
Number of Contacts	8 5	3*	7	2 5	16
Contact Size	12 16	8 for #10 or 12 wire	12	12 16	16

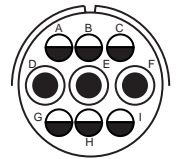
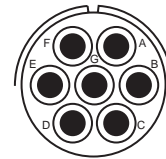
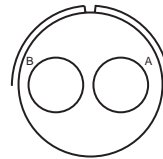
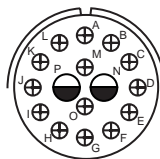
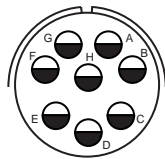

Insert Arrangement	24-6	24-7	24-9	24-10	24-11
Service Rating	A, G, H = D; Bal. = A	A	A	A	A
Number of Contacts	8	2 14	2	7	3 6
Contact Size	12	12 16	4	8	8 12

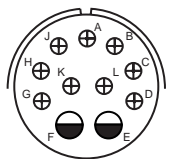
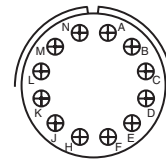
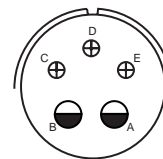
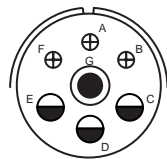
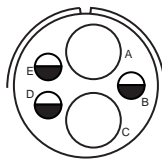

Insert Arrangement	24-12	24-16	24-17	24-19	24-20
Service Rating	A	A, B, F, G = D; C, D, E = A	D	A	D
Number of Contacts	2 3	1 3 3	2 3	12	2 9
Contact Size	4 12	8 12 16	12 16	16	12 16

* Solderless

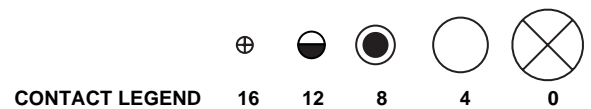

ACA-B

contact arrangements

front face of pin insert or rear face of socket insert illustrated

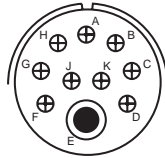

24-21

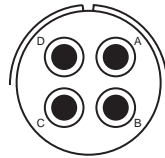

24-22

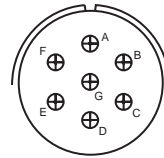

24-27

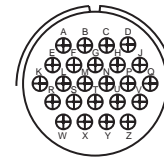

24-28

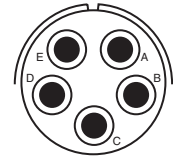

24-51

Insert Arrangement
Service Rating
Number of Contacts
Contact Size

D
1 9
8 16

D
4
8

E
7
16

Inst.
24
16

B, E for AN #10 or 12 wire
A, C, D for AN #8 wire

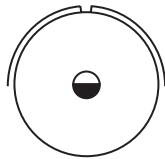

24-52

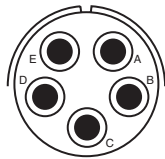

24-53

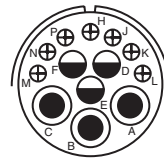

24-58

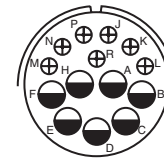

24-59

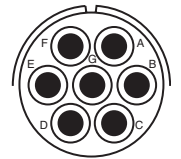

24-60

Insert Arrangement
Service Rating
Number of Contacts
Contact Size

Hi-Volt
1
12

A
5*
8

A
3 3 7
8 12 16

A
7 7
12 16

A
7*
8 for #10 or 12 wire

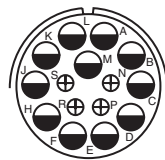

24-65

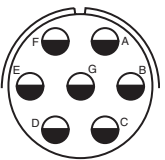

24-66

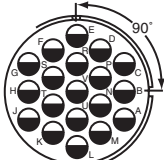

24-67

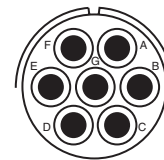

24-71

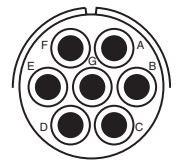

24-75

Insert Arrangement
Service Rating
Number of Contacts
Contact Size

A
11 4
12 16

D
7
12

Inst.
19
12

A
2* 5*
8 8 for #10 or 12 wire

A
5 2
8 8 for #16 wire

* Solderless

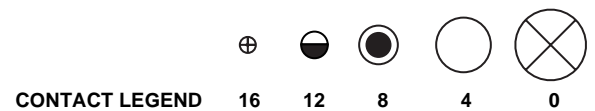

ACA-B

contact arrangements

front face of pin insert or rear face of socket insert illustrated

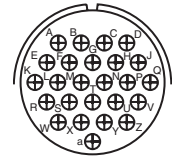
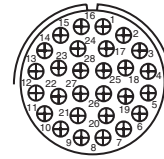
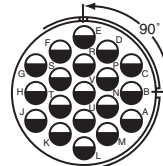
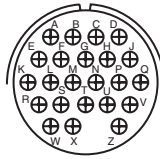
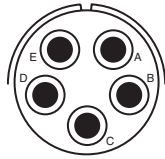

Insert Arrangement	24-79	24-80	24-84	24-96	24-AJ
Service Rating	A	Inst.	A	Inst.	A
Number of Contacts	5	23	1 18	28	25
Contact Size	8	16	12 12 (Coax) RG-188/U or RG-174/U	16	16

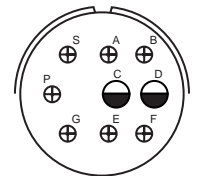
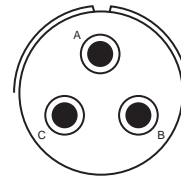
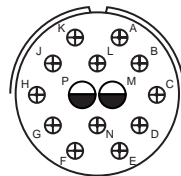
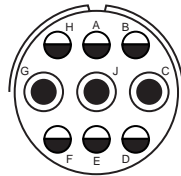

Insert Arrangement	28-1	28-2	28-3	28-4
Service Rating	A, J, E = D; Bal. = A	D	E	G, P, S = E; Bal. = D
Number of Contacts	3 6	2 12	3	2 7
Contact Size	8 12	12 16	8	12 16

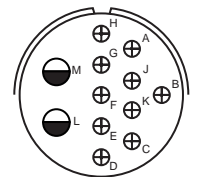
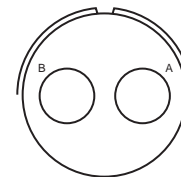
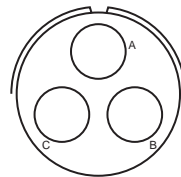
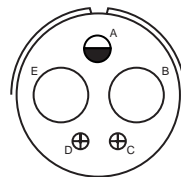

Insert Arrangement	28-5	28-6	28-7	28-8
Service Rating	D	D	D	L, M = E; B = D; Bal. = A
Number of Contacts	2 1 2	3	2	2 10
Contact Size	4 12 16	4	4	12 16

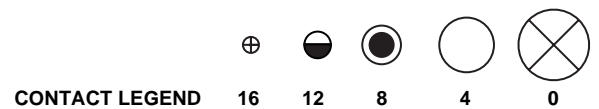

ACA-B

contact arrangements

front face of pin insert or rear face of socket insert illustrated

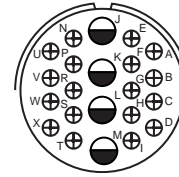
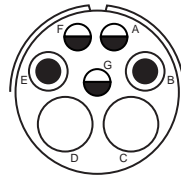
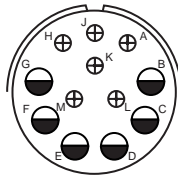

Insert Arrangement	28-9	28-10	28-11	28-12
Service Rating	D	G = D; Bal. = A	A	A
Number of Contacts	6 6	2 2 3	4 18	26
Contact Size	12 16	4 8 12	12 16	16

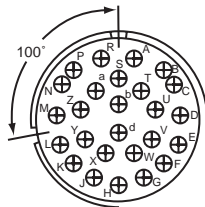

100° Rotation
of 32-6

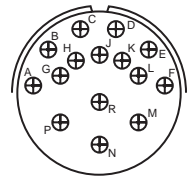
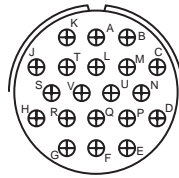
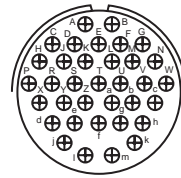

Insert Arrangement	28-13	28-15	28-16	28-17
Service Rating	A	A	A	R = B; M, N, P = D; A to L = A
Number of Contacts	26	35	20	15
Contact Size	16	16	16	16

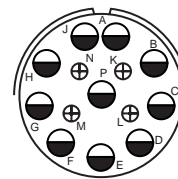
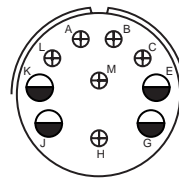
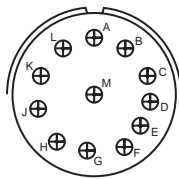

Insert Arrangement	28-18	28-19	28-20
Service Rating	M = C; G, H, J, K, L = D; A, B = A; Bal. = Inst.	H, M = B; A, B = D; Bal. = A	A
Number of Contacts	12	4 6	10 4
Contact Size	16	12 16	12 16

* Solderless



ACA-B

contact arrangements

front face of pin insert or rear face of socket insert illustrated

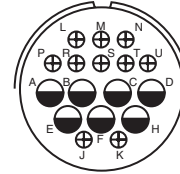
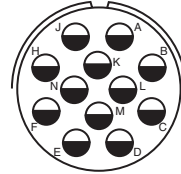
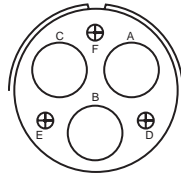
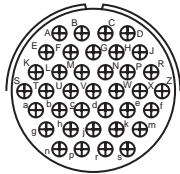

Insert Arrangement
Service Rating
Number of Contacts
Contact Size

28-21
A
37
16

28-22
D
3 3
4 16

28-51
A
12
12

28-59
A
7 10
12 16

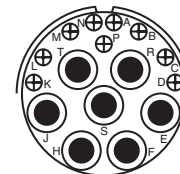
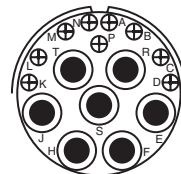
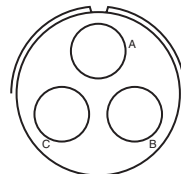
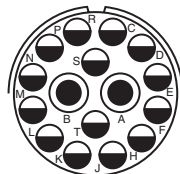

Insert Arrangement
Service Rating
Number of Contacts
Contact Size

28-66
A
2 14
8 12

28-72
-
3
4 (Coax) RG-59A/U
or RG-62A/U

28-74
A
9* 4* 3*
16 8 8 for #10 wire
(S, T, R)

28-75
A
9* 7*
16 8 for #10 wire

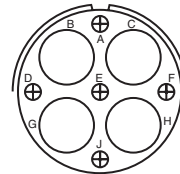
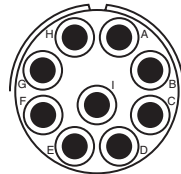
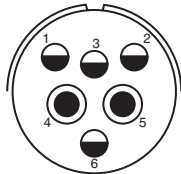

Insert Arrangement
Service Rating
Number of Contacts
Contact Size

28-79
A
7 9
8 16

28-82
D
2 4
8 12

28-84
A
9
8

28-AY
A
4 5
4 16

* Solderless



ACA-B

contact arrangements

front face of pin insert or rear face of socket insert illustrated

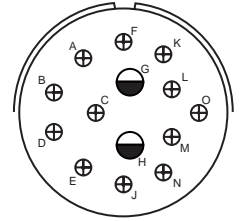
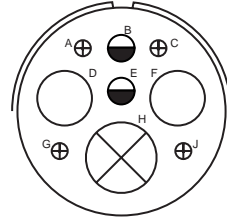
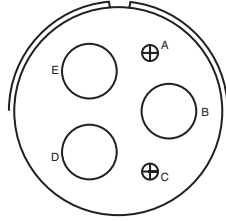
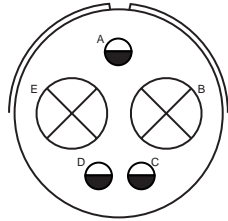

Insert Arrangement
Service Rating
Number of Contacts
Contact Size

32-1
A = E; B, C, D, E = D
2 3
0 12

32-2
E
3 2
4 16

32-3
D
1 2 2 4
0 4 12 16

32-4
F, J, K, N = A; Bal. = D
2 12
12 16

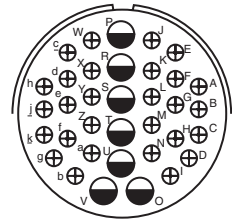
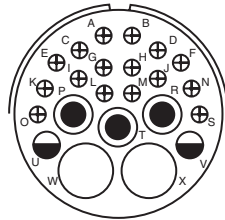
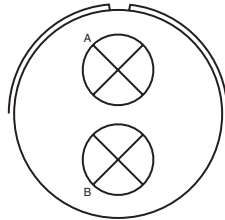

Insert Arrangement
Service Rating
Number of Contacts
Contact Size

32-5
D
2
0

32-6
A
2 3 2 16
4 8 12 16

32-7
A, B, h, j = Inst.; Bal. = A
7 28
12 16

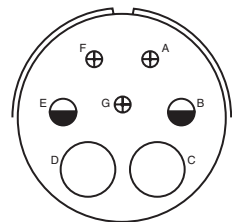
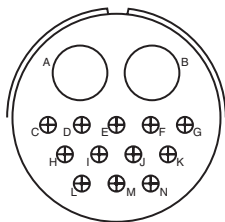
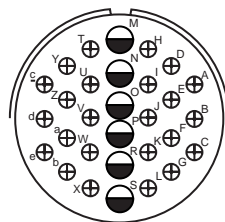

Insert Arrangement
Service Rating
Number of Contacts
Contact Size

32-8
A
6 24
12 16

32-9
D
2 12
4 16

32-10
A, F = E; G = B; B, E = D; C, D = A
2 2 3
4 8 16

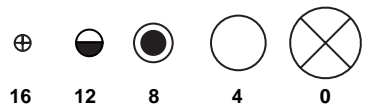

ACA-B

contact arrangements

front face of pin insert or rear face of socket insert illustrated

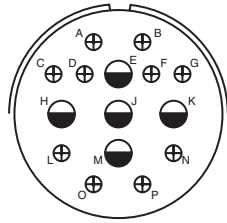

Insert Arrangement	32-12
Service Rating	C, D, E, F, G = A; Bal. = D
Number of Contacts	5 10
Contact Size	12 16

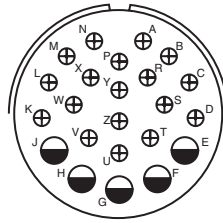

Insert Arrangement	32-13
Service Rating	D
Number of Contacts	5 18
Contact Size	12 16

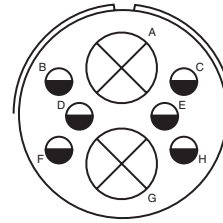

Insert Arrangement	32-15
Service Rating	D
Number of Contacts	2 6
Contact Size	0 12

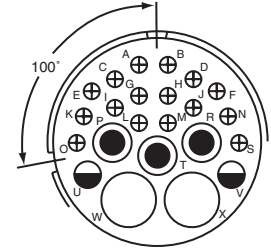

100° Rotation
of 32-6

Insert Arrangement	32-16
Service Rating	A
Number of Contacts	2 3 2 16
Contact Size	4 8 12 16

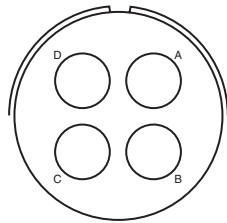

Insert Arrangement	32-17
Service Rating	D
Number of Contacts	4
Contact Size	4

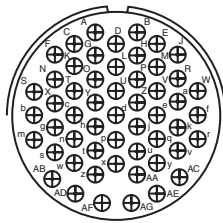

Insert Arrangement	32-22
Service Rating	A
Number of Contacts	54
Contact Size	16

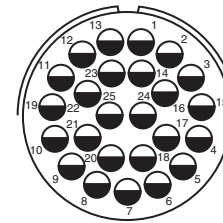

Insert Arrangement	32-25
Service Rating	A
Number of Contacts	25
Contact Size	12

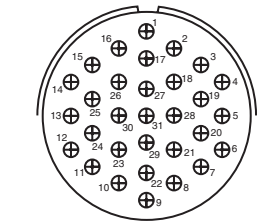

Insert Arrangement	32-31
Service Rating	A
Number of Contacts	31
Contact Size	16

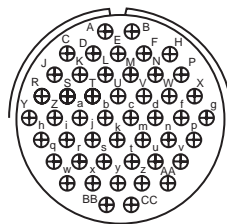

Insert Arrangement	32-48
Service Rating	Inst.
Number of Contacts	48
Contact Size	16

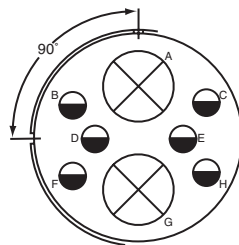

90° CW Rotation
of 32-15

Insert Arrangement	32-52
Service Rating	D
Number of Contacts	2 6
Contact Size	0 12

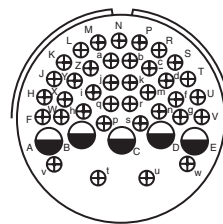

Insert Arrangement	32-53
Service Rating	t, u = E; Bal. = Inst.
Number of Contacts	5 37
Contact Size	12 16

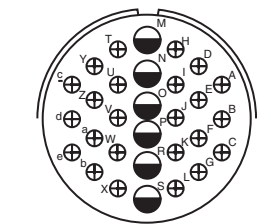

Insert Arrangement	32-56
Service Rating	A
Number of Contacts	24 6
Contact Size	16 12 for #10 wire



ACA-B

contact arrangements

front face of pin insert or rear face of socket insert illustrated

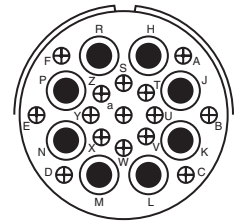
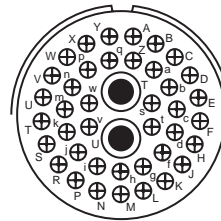
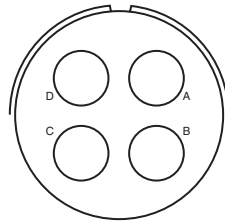
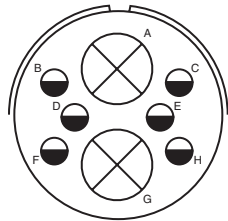

Insert Arrangement	32-57		32-58		32-59		32-60	
Service Rating	**		-		A		A	
Number of Contacts	6	2	4		40	2	15	8
Contact Size	12 0 (Coax) RG-71/U		4 (Coax) RG-161/U or RG-179/U		16	8 (Coax) RG-161/U	16	8 (Coax) RG-124/U

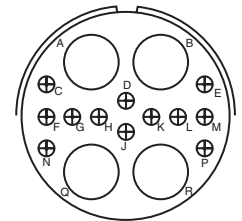
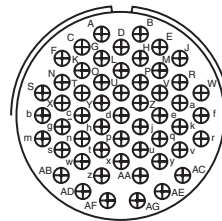
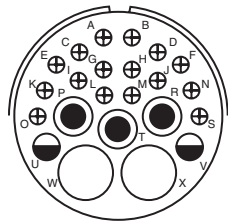

Insert Arrangement	32-62					32-64		32-68	
Service Rating	**					Inst.		A	
Number of Contacts	2	1	2	16	2	54		12	4
Contact Size	4	8	12	16	8 (Coax) RG-124/U	16		16	4 (Coax) RG-58C/U

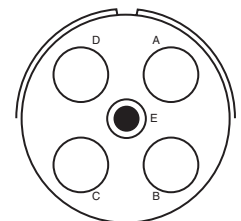
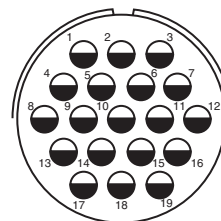
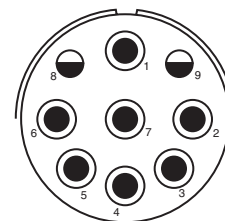
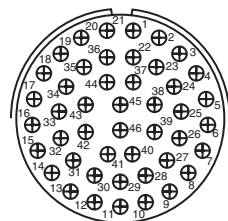

Insert Arrangement	32-73		32-75		32-76		32-79	
Service Rating	A		8, 9 = D		A		D	
Number of Contacts	46		2	7	19		4	1
Contact Size	16		12	8 (Coax) RG-180B/U	12		4	8



** Consult Amphenol, Sidney, NY for service rating of power contacts.

ACA-B

contact arrangements

front face of pin insert or rear face of socket insert illustrated

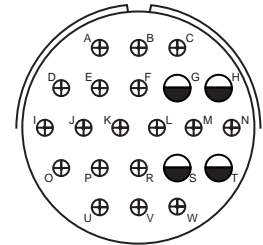
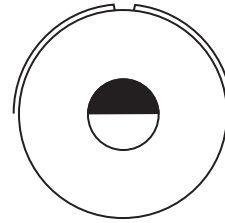
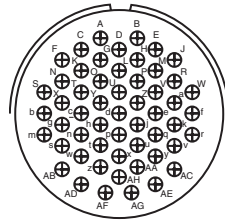
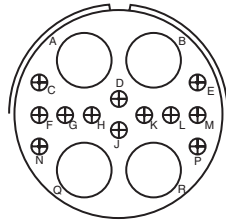

Insert Arrangement	32-82	32-AF	32-AM	36-1
Service Rating	A	A	A	D
Number of Contacts	4 12	55	1	4 18
Contact Size	4 16	16	4/0	12 16

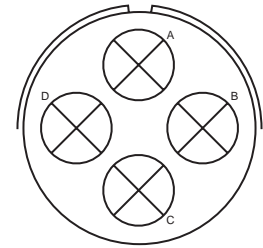
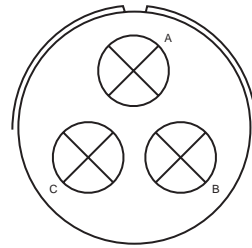
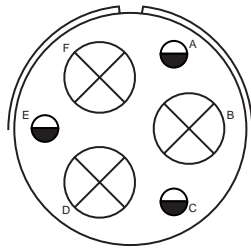

Insert Arrangement	36-3	36-4	36-5
Service Rating	D	A = D; B, C = A	A
Number of Contacts	3 3	3	4
Contact Size	0 12	0	0

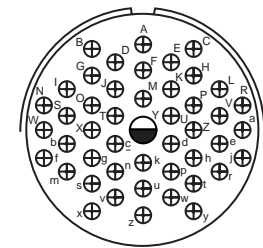
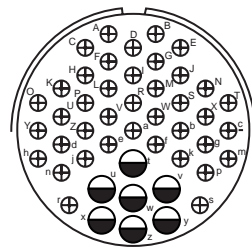
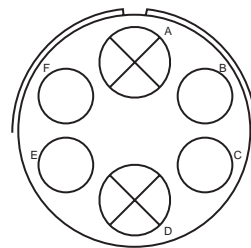

Insert Arrangement	36-6	36-7	36-8
Service Rating	A	A	A
Number of Contacts	2 4	7 40	1 46
Contact Size	0 4	12 16	12 16

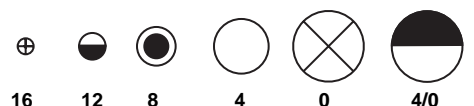

ACA-B

contact arrangements

front face of pin insert or rear face of socket insert illustrated

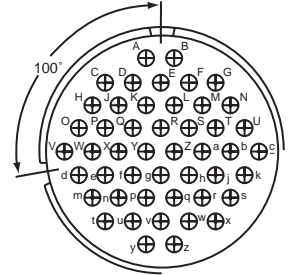
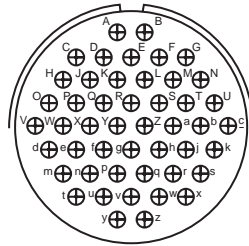
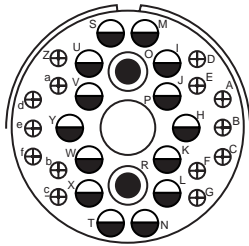

Insert Arrangement	36-9		
Service Rating	A		
Number of Contacts	1	2	14 14
Contact Size	4	8	12 16

36-10
A
48
16

100° Rotation
of 36-10

36-11
A
48
16

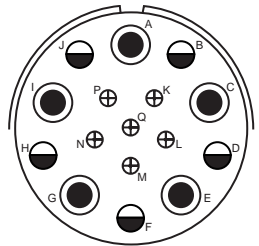
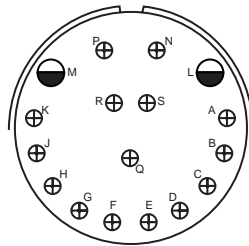
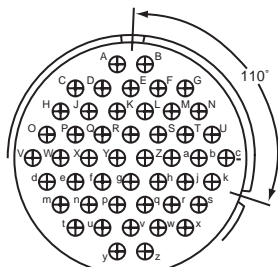

Insert Arrangement	36-12		
Service Rating	A		
Number of Contacts	48		
Contact Size	16		

36-13
N, P, Q = E; Bal. = A
2 15
12 16

36-14
D
5 5 6
8 12 16

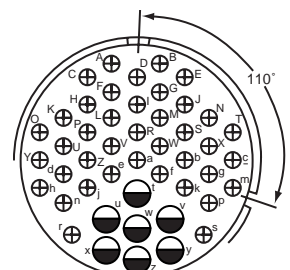
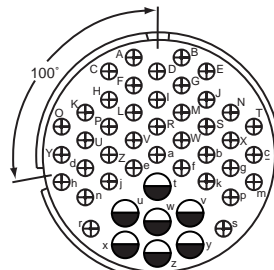
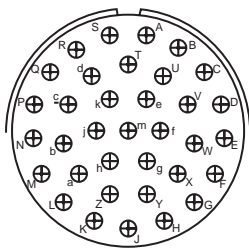

Insert Arrangement	36-15		
Service Rating	M = D; Bal. = A		
Number of Contacts	35		
Contact Size	16		

100° Rotation
of 36-7

36-16
A
7 40
12 16

110° Rotation
of 36-7

36-17
A
7 40
12 16

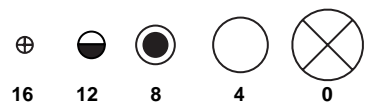

CONTACT LEGEND

16 12 8 4 0

ACA-B

contact arrangements

front face of pin insert or rear face of socket insert illustrated

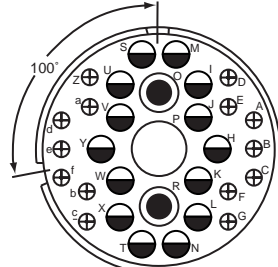

100° Rotation
of 36-9

Insert Arrangement

36-18

Service Rating

A

Number of Contacts

1 2 14 14

Contact Size

4 8 12 16

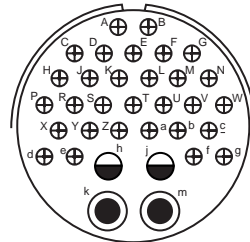

36-20

A

2 2 30

8 12 16

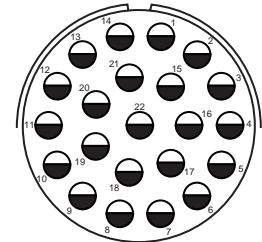

36-22

D

22

12

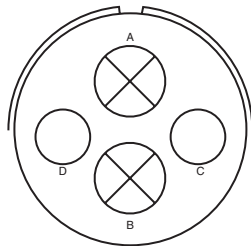

36-51

Insert Arrangement

Service Rating

D

Number of Contacts

2 2

Contact Size

0 4

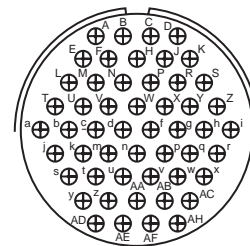

36-52

A

52

16

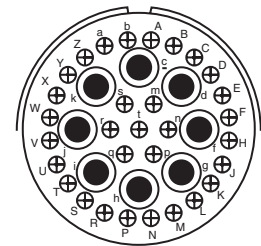

36-54

A

8 31

8 16

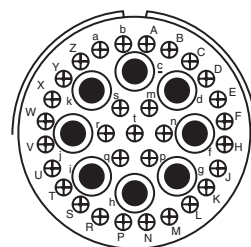

36-55

Insert Arrangement

Service Rating

A

Number of Contacts

31 8

Contact Size

16 8 for #6 wire

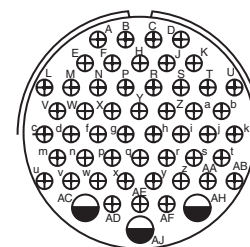

36-59

A

50 3

16 12 for #10 wire

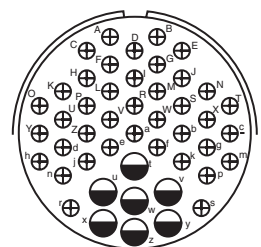

36-60

A

40 7

16 12 for #10 wire

CONTACT LEGEND

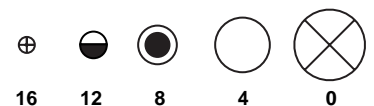

ACA-B

contact arrangements

front face of pin insert or rear face of socket insert illustrated

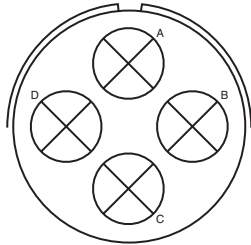

36-64

Insert Arrangement
Service Rating
Number of Contacts
Contact Size

—
 4
 0 (Coax) RG-11/U
 RG-12/U, or RG-13/U

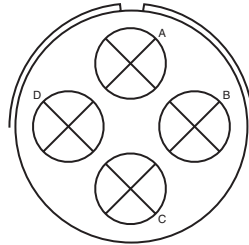

36-65

—
 4
 0 (Coax) RG-59/U, RG-62/U
 or RG-71/U

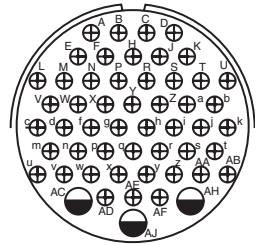

36-71

A
 3 50
 12 16

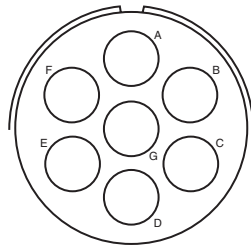

36-73

Insert Arrangement
Service Rating
Number of Contacts
Contact Size

—
 7
 4 (Coax) RG-62B/U

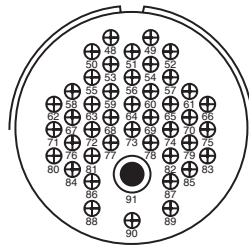

36-74

A
 43 1
 16 8 (Coax) RG-187/B

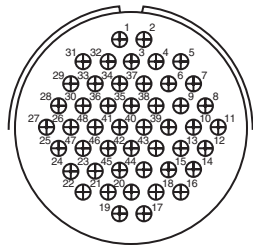

36-75

A
 48
 16 for #14 wire

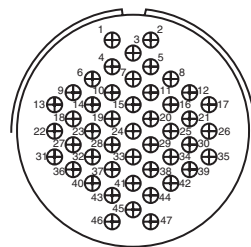

36-76

Insert Arrangement
Service Rating
Number of Contacts
Contact Size

A
 47
 16

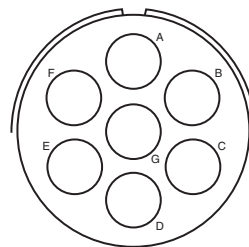

36-77

D
 7
 4

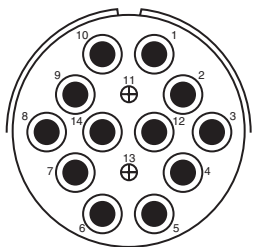

36-78

A
 2 12
 16 8



CONTACT LEGEND

16 12 8 4 0

ACA-B

contact arrangements

front face of pin insert or rear face of socket insert illustrated

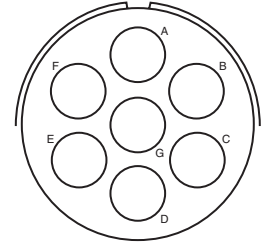
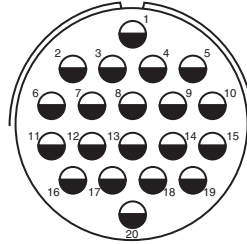
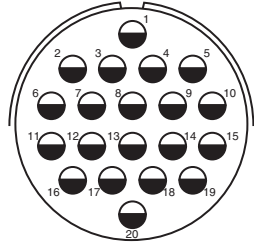

Insert Arrangement 36-79
Service Rating A
Number of Contacts 20
Contact Size 12

Insert Arrangement 36-80
Service Rating A
Number of Contacts 20
Contact Size 12 for #10 wire

Insert Arrangement 36-83
Service Rating -
Number of Contacts 7
Contact Size 4 (Coax) RG-58/U

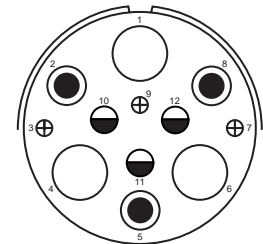
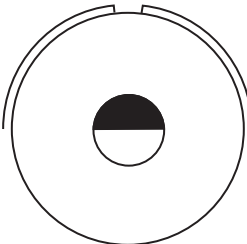
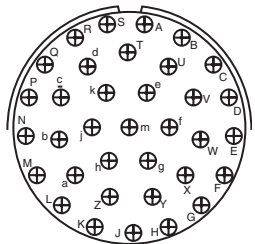

Insert Arrangement 36-85
Service Rating M = D; Bal. = A
Number of Contacts 35
Contact Size 16 for #12 wire

Insert Arrangement 36-97
Service Rating C
Number of Contacts 1
Contact Size 4/0

Insert Arrangement 36-99
Service Rating D
Number of Contacts 3 3 3 3
Contact Size 4 8 12 16

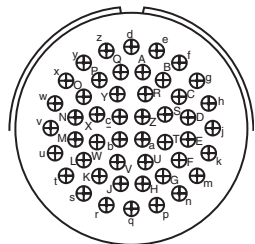

Insert Arrangement 36-AF
Service Rating A
Number of Contacts 48
Contact Size 16

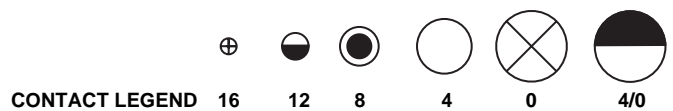

ACA-B Connector Classes

ACA 3100F-B

wall mount receptacle for front panel mounting

- Receptacle with solid backshell and rear accessory threads
- Four through mounting holes or optional metric threaded holes
- Includes grommet and grommet sleeve

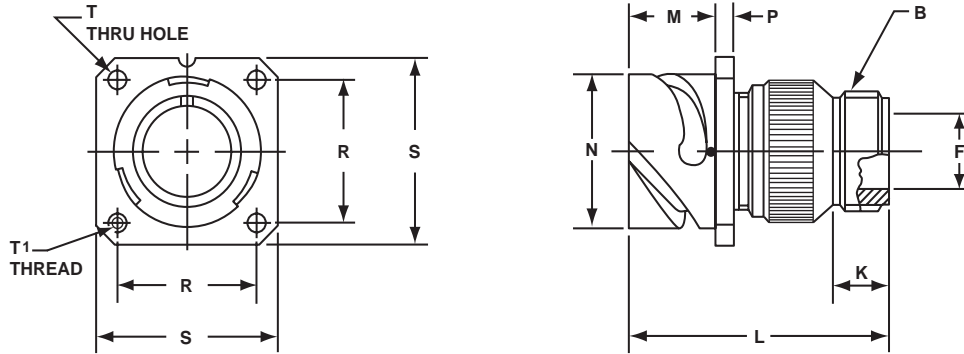

Inches

Shell Size	B Thread Class 2A	F Min.	K Min.	L Max.	M + .016 - .000	N + .000 - .006	P ± .008	R ± .004	S ± .012	T Thru Hole + .004 - .000
10SL	.6250-24 UNEF	.409	.374	1.969	.717	.717	.110	.717	1.000	.126
14S	.7500-20 UNEF	.520	.374	1.969	.717	.969	.126	.906	1.181	.126
16S	.8750-20 UNEF	.638	.374	1.969	.717	1.079	.126	.969	1.280	.126
16	.8750-20 UNEF	.638	.374	2.362	.846	1.079	.126	.969	1.280	.126
18	1.0000-20 UNEF	.756	.374	2.362	.907	1.213	.157	1.063	1.378	.126
20	1.1875-18 UNEF	.867	.374	2.362	.907	1.346	.157	1.157	1.496	.126
22	1.1875-18 UNEF	.965	.374	2.362	.907	1.472	.157	1.252	1.614	.126
24	1.4375-18 UNEF	1.094	.374	2.560	.907	1.610	.157	1.374	1.752	.146
28	1.4375-18 UNEF	1.228	.374	2.560	.947	1.839	.157	1.563	2.000	.146
32	1.7500-18 UNS	1.488	.433	2.560	.947	2.102	.157	1.752	2.244	.169
36	2.0000-18 UNS	1.780	.465	3.150	.947	2.346	.157	1.937	2.500	.169

Millimeters

Shell Size	F Min.	K Min.	L Max.	M + 0.4 - 0.0	N + 0.00 - 0.15	P ± 0.2	R ± 0.1	S ± 0.3	T Thru Hole + 0.1 - 0.0	T ¹ Metric Thread
10SL	10.4	9.5	50	18.2	18.2	2.8	18.2	25.4	3.2	M4
14S	13.2	9.5	50	18.2	24.6	3.2	23.0	30.0	3.2	M4
16S	16.2	9.5	50	18.2	27.4	3.2	24.6	32.5	3.2	M4
16	16.2	9.5	60	21.5	27.4	3.2	24.6	32.5	3.2	M4
18	19.2	9.5	60	23.0	30.8	4.0	27.0	35.0	3.2	M4
20	22.0	9.5	60	23.0	34.2	4.0	29.4	38.0	3.2	M4
22	24.5	9.5	60	23.0	37.4	4.0	31.8	41.0	3.2	M4
24	27.8	9.5	65	23.0	40.9	4.0	34.9	44.5	3.7	M4
28	31.2	9.5	65	24.1	46.7	4.0	39.7	50.8	3.7	M5
32	37.8	11.0	65	24.1	53.4	4.0	44.5	57.0	4.3	M5
36	45.2	11.8	80	24.1	59.6	4.0	49.2	63.5	4.3	M5

All dimensions for reference only.

ACA 3100E-B

wall mount receptacle for front panel mounting

- Receptacle with cable clamp and telescopic bushing
- Includes grommet and grommet sleeve
- Four through mounting holes or optional metric threaded holes

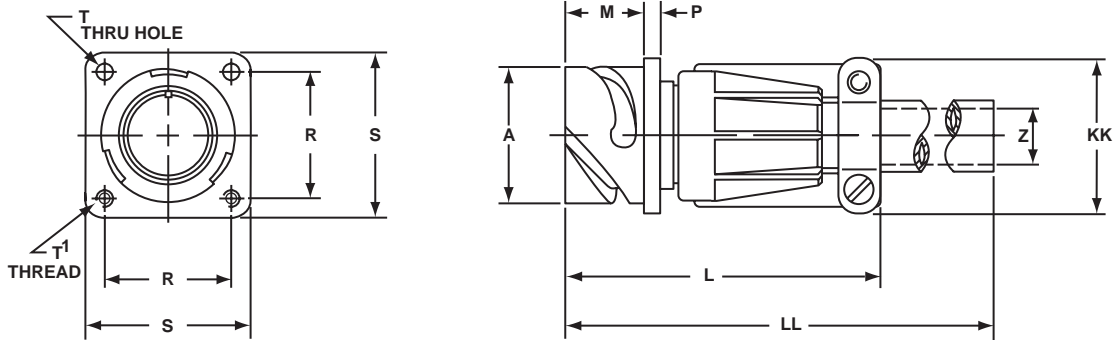

Inches

Shell Size	L Max.	M + .016 - .000	N + .000 - .006	P ± .008	R ± .004	S ± .012	T Thru Hole + .004 - .000	Z Max.	KK Max.	LL Max.
10SL	2.362	.717	.717	.110	.717	1.000	.126	.256	.894	4.720
14S	2.440	.717	.969	.126	.906	1.181	.126	.354	1.083	4.720
16S	2.756	.717	1.079	.126	.969	1.280	.126	.433	1.181	4.720
16	2.756	.846	1.079	.126	.969	1.280	.126	.433	1.181	4.921
18	3.031	.907	1.213	.157	1.063	1.378	.126	.559	1.300	4.921
20	3.031	.907	1.346	.157	1.157	1.496	.126	.622	1.476	4.921
22	3.031	.907	1.472	.157	1.252	1.614	.126	.622	1.476	4.921
24	3.346	.907	1.610	.157	1.374	1.752	.146	.843	1.705	4.921
28	3.346	.947	1.839	.157	1.563	2.000	.146	.843	1.705	4.921
32	3.346	.947	2.102	.157	1.752	2.244	.169	1.051	2.035	4.921
36	4.134	.947	2.346	.157	1.937	2.500	.169	1.248	2.283	5.315

Millimeters

Shell Size	L Max.	M + 0.4 - 0.0	N + 0.00 - 0.15	P ± 0.2	R ± 0.1	S ± 0.3	T Thru Hole + 0.1 - 0.0	T ¹ Metric Thread	Z Max.	KK Max.	LL Max.
10SL	60	18.2	18.2	2.8	18.2	25.4	3.2	M4	6.5	22.7	120
14S	62	18.2	24.6	3.2	23.0	30.0	3.2	M4	9.0	27.5	120
16S	70	18.2	27.4	3.2	24.6	32.5	3.2	M4	11.0	30.0	120
16	70	21.5	27.4	3.2	24.6	32.5	3.2	M4	11.0	30.0	125
18	77	23.0	30.8	4.0	27.0	35.0	3.2	M4	14.2	33.0	125
20	77	23.0	34.2	4.0	29.4	38.0	3.2	M4	15.8	37.5	125
22	77	23.0	37.4	4.0	31.8	41.0	3.2	M4	15.8	37.5	125
24	85	23.0	40.9	4.0	34.9	44.5	3.7	M4	21.4	43.3	125
28	85	24.1	46.7	4.0	39.7	50.8	3.7	M5	21.4	43.3	125
32	85	24.1	53.4	4.0	44.5	57.0	4.3	M5	26.7	51.7	125
36	105	24.1	59.6	4.0	49.2	63.5	4.3	M5	31.7	58.0	135

All dimensions for reference only.

ACA 3100G-B

wall mount receptacle for front panel mounting

- Receptacle with endbell for heat shrink termination
- Does not include grommet and grommet sleeve
- Four through mounting holes or optional metric threaded holes

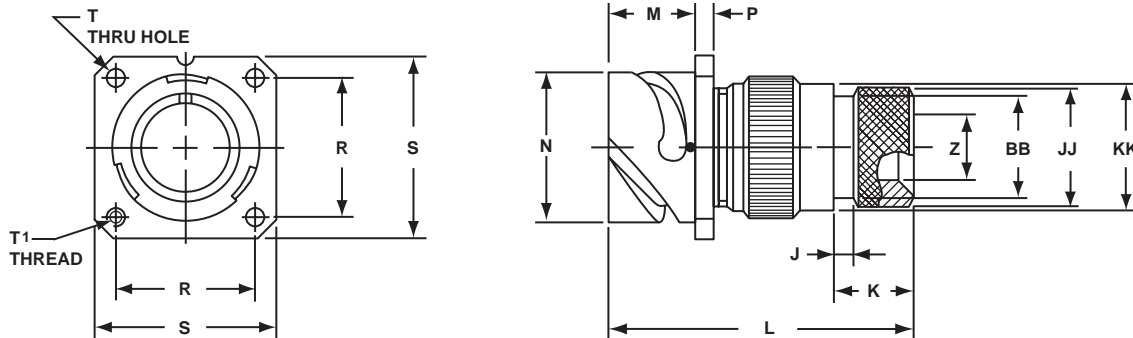

Inches

Shell Size	J ± .008	K ± .020	L Max.	M + .016 - .000	N + .000 - .006	P ± .008	R ± .004	S ± .012	T Thru Hole + .004 - .000	Z Min.	BB Max.	JJ ± .008	KK ± .008
10SL	.138	.461	1.969	.717	.717	.110	.717	1.000	.126	.303	.524	.610	.669
14S	.138	.461	1.969	.717	.969	.126	.906	1.181	.126	.417	.669	.752	.791
16S	.138	.461	1.969	.717	1.079	.126	.969	1.280	.126	.531	.862	.941	.925
16	.138	.453	2.362	.846	1.079	.126	.969	1.280	.126	.531	.862	.941	.925
18	.138	.453	2.362	.907	1.213	.157	1.063	1.378	.126	.575	.862	.941	1.043
20	.138	.500	2.559	.907	1.346	.157	1.157	1.496	.126	.736	1.031	1.165	1.189
22	.138	.500	2.559	.907	1.472	.157	1.252	1.614	.126	.819	1.031	1.165	1.323
24	.138	.500	2.559	.907	1.610	.157	1.374	1.752	.146	.969	1.358	1.488	1.421
28	.138	.500	2.559	.947	1.839	.157	1.563	2.000	.146	1.062	1.358	1.488	1.630
32	.138	.598	2.756	.947	2.102	.157	1.752	2.244	.169	1.311	1.717	1.882	1.913
36	.138	.598	3.150	.947	2.346	.157	1.937	2.500	.169	1.516	1.717	1.882	2.157

Millimeters

Shell Size	J ± 0.2	K ± 0.5	L Max.	M + 0.4 - 0.0	N + 0.00 - 0.15	P ± 0.2	R ± 0.1	S ± 0.3	T Thru Hole + 0.1 - 0.0	T ¹ Metric Thread	Z Min.	BB Max.	JJ ± 0.2	KK ± 0.2
10SL	3.5	11.7	50	18.2	18.2	2.8	18.2	25.4	3.2	M4	7.7	13.3	15.5	17.0
14S	3.5	11.7	50	18.2	24.6	3.2	23.0	30.0	3.2	M4	10.6	17.0	19.1	20.1
16S	3.5	11.7	50	18.2	27.4	3.2	24.6	32.5	3.2	M4	13.5	21.9	23.9	23.5
16	3.5	11.5	60	21.5	27.4	3.2	24.6	32.5	3.2	M4	13.5	21.9	23.9	23.5
18	3.5	11.5	60	23.0	30.8	4.0	27.0	35.0	3.2	M4	14.6	21.9	23.9	26.5
20	3.5	12.7	65	23.0	34.2	4.0	29.4	38.0	3.2	M4	18.7	26.2	29.6	30.2
22	3.5	12.7	65	23.0	37.4	4.0	31.8	41.0	3.2	M4	20.8	26.2	29.6	33.6
24	3.5	12.7	65	23.0	40.9	4.0	34.9	44.5	3.7	M4	24.6	34.5	37.8	36.1
28	3.5	12.7	65	24.1	46.7	4.0	39.7	50.8	3.7	M5	27.0	34.5	37.8	41.4
32	3.5	15.2	70	24.1	53.4	4.0	44.5	57.0	4.3	M5	33.3	43.6	47.8	48.6
36	3.5	15.2	80	24.1	59.6	4.0	49.2	63.5	4.3	M5	38.5	43.6	47.8	54.8

All dimensions for reference only.

ACA 3100R-B

wall mount receptacle for front panel mounting

- Receptacle with short endbell for individual wire sealing
- Includes grommet and grommet sleeve
- Four through mounting holes or optional metric threaded holes

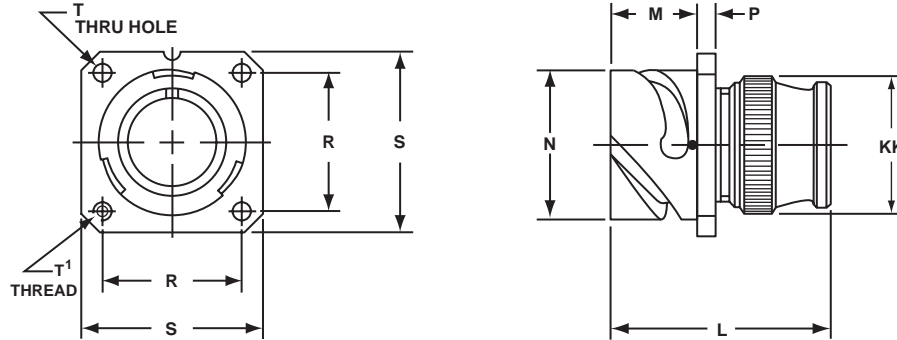

Inches

Shell Size	L Max.	M + .016 - .000	N + .000 - .006	P ± .008	R ± .004	S ± .012	T Thru Hole + .004 - .000	KK Max.
10SL	1.890	.717	.717	.110	.717	1.000	.126	.787
14S	1.890	.717	.969	.126	.906	1.181	.126	.945
16S	1.890	.717	1.079	.126	.969	1.280	.126	1.024
16	2.205	.846	1.079	.126	.969	1.280	.126	1.024
18	2.244	.907	1.213	.157	1.063	1.378	.126	1.161
20	2.244	.907	1.346	.157	1.157	1.496	.126	1.299
22	2.244	.907	1.472	.157	1.252	1.614	.126	1.417
24	2.244	.907	1.610	.157	1.374	1.752	.146	1.575
28	2.244	.947	1.839	.157	1.563	2.000	.146	1.811
32	2.362	.947	2.102	.157	1.752	2.244	.169	2.028
36	2.362	.947	2.346	.157	1.937	2.500	.169	2.283

Millimeters

Shell Size	L Max.	M + 0.4 - 0.0	N + 0.00 - 0.15	P ± 0.2	R ± 0.1	S ± 0.3	T Thru Hole + 0.1 - 0.0	T ¹ Metric Thread	KK Max.
10SL	48.0	18.2	18.2	2.8	18.2	25.4	3.2	M4	20.0
14S	48.0	18.2	24.6	3.2	23.0	30.0	3.2	M4	24.0
16S	48.0	18.2	27.4	3.2	24.6	32.5	3.2	M4	26.0
16	56.0	21.5	27.4	3.2	24.6	32.5	3.2	M4	26.0
18	57.0	23.0	30.8	4.0	27.0	35.0	3.2	M4	29.5
20	57.0	23.0	34.2	4.0	29.4	38.0	3.2	M4	33.0
22	57.0	23.0	37.4	4.0	31.8	41.0	3.2	M4	36.0
24	57.0	23.0	40.9	4.0	34.9	44.5	3.7	M4	40.0
28	57.0	24.1	46.7	4.0	39.7	50.8	3.7	M5	46.0
32	60.0	24.1	53.4	4.0	44.5	57.0	4.3	M5	51.5
36	60.0	24.1	59.6	4.0	49.2	63.5	4.3	M5	58.0

All dimensions for reference only.

ACA 3101F-B

inline receptacle

- Receptacle with solid backshell and rear accessory threads
- Includes grommet and grommet sleeve

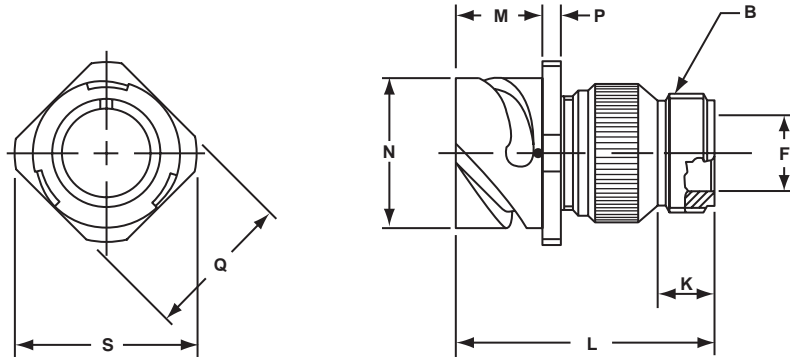

Inches

Shell Size	B Thread Class 2A	F Min.	K Min.	L Max.	M +.016 -.000	N +.000 -.006	P ±.008	Q ±.008	S Max.
10SL	.6250-24 UNEF	.409	.374	1.969	.717	.717	.110	.811	.992
14S	.7500-20 UNEF	.520	.374	1.969	.717	.969	.126	1.000	1.173
16S	.8750-20 UNEF	.638	.374	1.969	.717	1.079	.126	1.126	1.272
16	.8750-20 UNEF	.638	.374	2.362	.846	1.079	.126	1.126	1.272
18	1.0000-20 UNEF	.756	.374	2.362	.907	1.213	.157	1.248	1.370
20	1.1875-18 UNEF	.867	.374	2.362	.907	1.346	.157	1.374	1.488
22	1.1875-18 UNEF	.965	.374	2.362	.907	1.472	.157	1.500	1.618
24	1.4375-18 UNEF	1.094	.374	2.560	.907	1.610	.157	1.626	1.756
28	1.4375-18 UNEF	1.228	.374	2.560	.947	1.839	.157	1.874	2.004
32	1.7500-18 UNS	1.488	.433	2.560	.947	2.102	.157	2.126	2.248
36	2.0000-18 UNS	1.780	.465	3.150	.947	2.346	.157	2.386	2.504

Millimeters

Shell Size	F Min.	K Min.	L Max.	M +0.4 -0.0	N +0.00 -0.15	P ±0.2	Q ±0.2	S Max.
10SL	10.4	9.5	50	18.2	18.2	2.8	20.6	25.2
14S	13.2	9.5	50	18.2	24.6	3.2	25.4	29.8
16S	16.2	9.5	50	18.2	27.4	3.2	28.6	32.3
16	16.2	9.5	60	21.5	27.4	3.2	28.6	32.3
18	19.2	9.5	60	23.0	30.8	4.0	31.7	34.8
20	22.0	9.5	60	23.0	34.2	4.0	34.9	37.8
22	24.5	9.5	60	23.0	37.4	4.0	38.1	41.1
24	27.8	9.5	65	23.0	40.9	4.0	41.3	44.6
28	31.2	9.5	65	24.1	46.7	4.0	47.6	50.9
32	37.8	11.0	65	24.1	53.4	4.0	54.0	57.1
36	45.2	11.8	80	24.1	59.6	4.0	60.6	63.6

All dimensions for reference only.

ACA 3101E-B

inline receptacle

- Receptacle with cable clamp and telescopic bushing
- Includes grommet and grommet sleeve

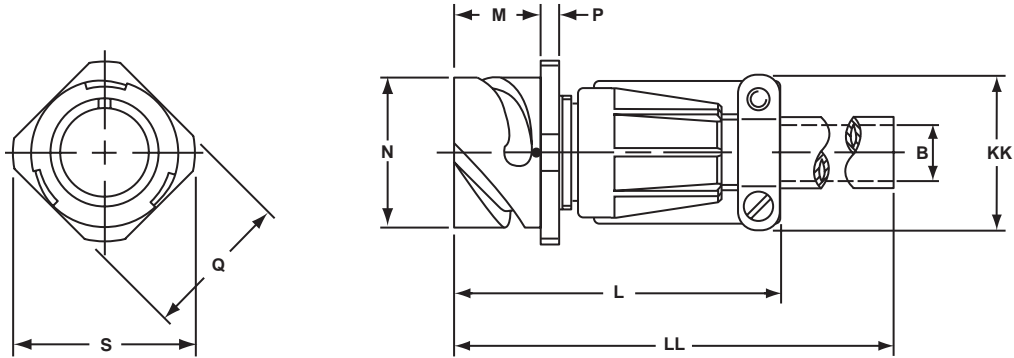

Inches

Shell Size	B Max.	L Max.	M + .016 - .000	N + .000 - .006	P ± .008	Q Max.	S Max.	KK Max.	LL Max.
10SL	.256	2.362	.717	.717	.110	.886	.992	.894	4.720
14S	.354	2.440	.717	.969	.126	1.161	1.173	1.083	4.720
16S	.433	2.756	.717	1.079	.126	1.240	1.272	1.181	4.720
16	.433	2.756	.846	1.079	.126	1.240	1.272	1.181	4.921
18	.559	3.031	.907	1.213	.157	1.358	1.370	1.300	4.921
20	.622	3.031	.907	1.346	.157	1.476	1.488	1.476	4.921
22	.622	3.031	.907	1.472	.157	1.594	1.618	1.476	4.921
24	.843	3.346	.907	1.610	.157	1.752	1.756	1.705	4.921
28	.843	3.346	.947	1.839	.157	1.969	2.004	1.705	4.921
32	1.051	3.346	.947	2.102	.157	2.224	2.248	2.035	4.921
36	1.248	4.134	.947	2.346	.157	2.480	2.504	2.283	5.315

Millimeters

Shell Size	B Max.	L Max.	M + 0.4 - 0.0	N + 0.00 - 0.15	P ± 0.2	Q Max.	S Max.	KK Max.	LL Max.
10SL	6.5	60	18.2	18.2	2.8	22.5	25.2	22.7	120
14S	9.0	62	18.2	24.6	3.2	29.5	29.8	27.5	120
16S	11.0	70	18.2	27.4	3.2	31.5	32.3	30.0	120
16	11.0	70	21.5	27.4	3.2	31.5	32.3	30.0	125
18	14.2	77	23.0	30.8	4.0	34.5	34.8	33.0	125
20	15.8	77	23.0	34.2	4.0	37.5	37.8	37.5	125
22	15.8	77	23.0	37.4	4.0	40.5	41.1	37.5	125
24	21.4	85	23.0	40.9	4.0	44.5	44.6	43.3	125
28	21.4	85	24.1	46.7	4.0	50.0	50.9	43.3	125
32	26.7	85	24.1	53.4	4.0	56.5	57.1	51.7	125
36	31.7	105	24.1	59.6	4.0	63.0	63.6	58.0	135

All dimensions for reference only.

ACA 3101G-B

inline receptacle

- Receptacle with backshell for heat shrink termination
- Does not include grommet and grommet sleeve

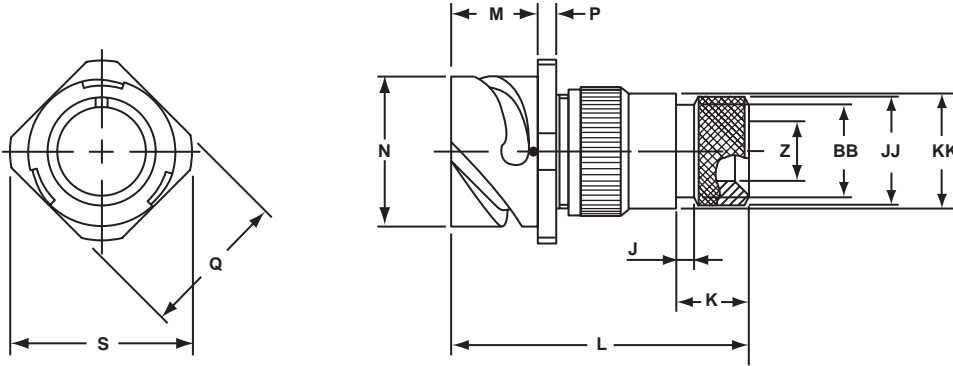

Inches

Shell Size	J ± .008	K ± .020	L Max.	M + .016 - .000	N + .000 - .006	P ± .008	Q Max.	S Max.	Z Min.	BB Max.	JJ ± .008	KK ± .008
10SL	.138	.461	1.969	.717	.717	.110	.886	.992	.303	.524	.610	.669
14S	.138	.461	1.969	.717	.969	.126	1.161	1.173	.417	.669	.752	.791
16S	.138	.461	1.969	.717	1.079	.126	1.240	1.272	.531	.862	.941	.925
16	.138	.453	2.362	.846	1.079	.126	1.240	1.272	.531	.862	.941	.925
18	.138	.453	2.362	.907	1.213	.157	1.358	1.370	.575	.862	.941	1.043
20	.138	.500	2.559	.907	1.346	.157	1.476	1.488	.736	1.031	1.165	1.189
22	.138	.500	2.559	.907	1.472	.157	1.594	1.618	.819	1.031	1.165	1.323
24	.138	.500	2.559	.907	1.610	.157	1.752	1.756	.969	1.358	1.488	1.421
28	.138	.500	2.559	.947	1.839	.157	1.969	2.004	1.062	1.358	1.488	1.630
32	.138	.598	2.756	.947	2.102	.157	2.224	2.248	1.311	1.717	1.882	1.913
36	.138	.598	3.150	.947	2.346	.157	2.480	2.504	1.516	1.717	1.882	2.157

Millimeters

Shell Size	J ± 0.2	K ± 0.5	L Max.	M + 0.4 - 0.0	N + 0.00 - 0.15	P ± 0.2	Q Max.	S Max.	Z Min.	BB Max.	JJ ± 0.2	KK ± 0.2
10SL	3.5	11.7	50	18.2	18.2	2.8	22.5	25.2	7.7	13.3	15.5	17.0
14S	3.5	11.7	50	18.2	24.6	3.2	29.5	29.8	10.6	17.0	19.1	20.1
16S	3.5	11.7	50	18.2	27.4	3.2	31.5	32.3	13.5	21.9	23.9	23.5
16	3.5	11.5	60	21.5	27.4	3.2	31.5	32.3	13.5	21.9	23.9	23.5
18	3.5	11.5	60	23.0	30.8	4.0	34.5	34.8	14.6	21.9	23.9	26.5
20	3.5	12.7	65	23.0	34.2	4.0	37.5	37.8	18.7	26.2	29.6	30.2
22	3.5	12.7	65	23.0	37.4	4.0	40.5	41.1	20.8	26.2	29.6	33.6
24	3.5	12.7	65	23.0	40.9	4.0	44.5	44.6	24.6	34.5	37.8	36.1
28	3.5	12.7	65	24.1	46.7	4.0	50.0	50.9	27.0	34.5	37.8	41.4
32	3.5	15.2	70	24.1	53.4	4.0	56.5	57.1	33.3	43.6	47.8	48.6
36	3.5	15.2	80	24.1	59.6	4.0	63.0	63.6	38.5	43.6	47.8	54.8

All dimensions for reference only.

ACA 3101R-B

inline receptacle

- Receptacle with short endbell for individual wire sealing
- Includes grommet and grommet sleeve

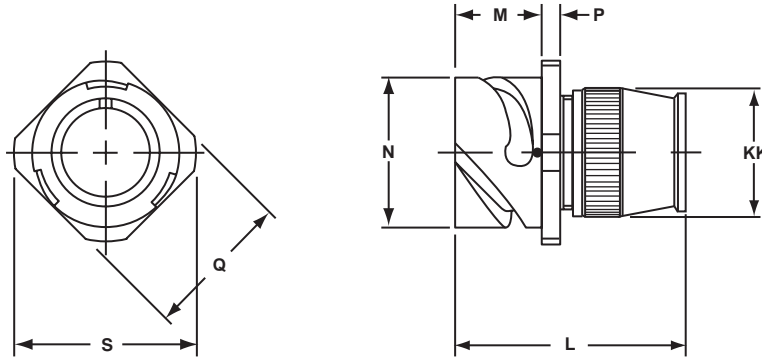

Inches

Shell Size	L Max.	M + .016 - .000	N + .000 - .006	P ± .008	Q Max.	S Max.	KK Max.
10SL	1.890	.717	.717	.110	.886	.992	.787
14S	1.890	.717	.969	.126	1.161	1.173	.945
16S	1.890	.717	1.079	.126	1.240	1.272	1.024
16	2.205	.846	1.079	.126	1.240	1.272	1.024
18	2.244	.907	1.213	.157	1.358	1.370	1.161
20	2.244	.907	1.346	.157	1.476	1.488	1.299
22	2.244	.907	1.472	.157	1.594	1.618	1.417
24	2.244	.907	1.610	.157	1.752	1.756	1.575
28	2.244	.947	1.839	.157	1.969	2.004	1.811
32	2.362	.947	2.102	.157	2.224	2.248	2.028
36	2.362	.947	2.346	.157	2.480	2.504	2.283

Millimeters

Shell Size	L Max.	M + 0.4 - 0.0	N + 0.00 - 0.15	P ± 0.2	Q Max.	S Max.	KK Max.
10SL	48.0	18.2	18.2	2.8	22.5	25.2	20.0
14S	48.0	18.2	24.6	3.2	29.5	29.8	24.0
16S	48.0	18.2	27.4	3.2	31.5	32.3	26.0
16	56.0	21.5	27.4	3.2	31.5	32.3	26.0
18	57.0	23.0	30.8	4.0	34.5	34.8	29.5
20	57.0	23.0	34.2	4.0	37.5	37.8	33.0
22	57.0	23.0	37.4	4.0	40.5	41.1	36.0
24	57.0	23.0	40.9	4.0	44.5	44.6	40.0
28	57.0	24.1	46.7	4.0	50.0	50.9	46.0
32	60.0	24.1	53.4	4.0	56.5	57.1	51.5
36	60.0	24.1	59.6	4.0	63.0	63.6	58.0

All dimensions for reference only.

ACA 3102E-B

box mount receptacle for front panel mounting

- Receptacle without threads for panel mounting
- Four through mounting holes or optional metric threaded holes

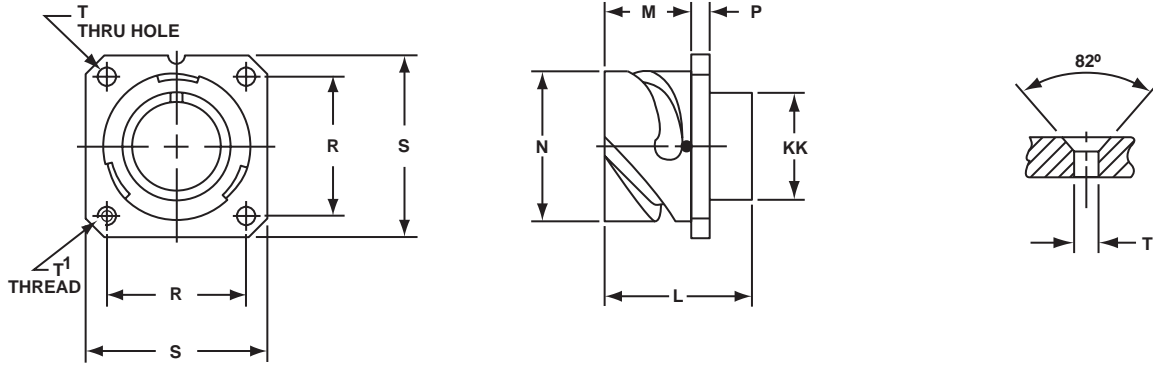

Inches

Shell Size	L ± .012	M + .016 - .000	N + .000 - .006	P ± .008	R ± .004	S ± .012	T Thru Hole + .004 - .000	KK Max.
10SL	1.087	.717	.717	.110	.717	1.000	.126	.626
14S	1.087	.717	.969	.126	.906	1.181	.126	.756
16S	1.087	.717	1.079	.126	.969	1.280	.126	.882
16	1.331	.846	1.079	.126	.969	1.280	.126	.882
18	1.331	.907	1.213	.157	1.063	1.378	.126	1.008
20	1.331	.907	1.346	.157	1.157	1.496	.126	1.142
22	1.331	.907	1.472	.157	1.252	1.614	.126	1.268
24	1.331	.907	1.610	.157	1.374	1.752	.146	1.390
28	1.406	.947	1.839	.157	1.563	2.000	.146	1.630
32	1.469	.947	2.102	.157	1.752	2.244	.169	1.882
36	1.469	.947	2.346	.157	1.937	2.500	.169	2.063

Millimeters

Shell Size	L ± 0.3	M + 0.4 - 0.0	N + 0.00 - 0.15	P ± 0.2	R ± 0.1	S ± 0.3	T Thru Hole + 0.1 - 0.0	T ¹ Metric Thread	KK Max.
10SL	27.6	18.2	18.2	2.8	18.2	25.4	3.2	M4	15.9
14S	27.6	18.2	24.6	3.2	23.0	30.0	3.2	M4	19.2
16S	27.6	18.2	27.4	3.2	24.6	32.5	3.2	M4	22.4
16	33.8	21.5	27.4	3.2	24.6	32.5	3.2	M4	22.4
18	33.8	23.0	30.8	4.0	27.0	35.0	3.2	M4	25.6
20	33.8	23.0	34.2	4.0	29.4	38.0	3.2	M4	29.0
22	33.8	23.0	37.4	4.0	31.8	41.0	3.2	M4	32.2
24	33.8	23.0	40.9	4.0	34.9	44.5	3.7	M4	35.3
28	35.7	24.1	46.7	4.0	39.7	50.8	3.7	M5	41.4
32	37.3	24.1	53.4	4.0	44.5	57.0	4.3	M5	47.8
36	37.3	24.1	59.6	4.0	49.2	63.5	4.3	M5	52.4

All dimensions for reference only.

ACA 3103F-B

wall mounting receptacle for rear panel mounting

- Receptacle with backshell and rear accessory threads
- Includes wire sealing grommet and grommet sleeve for individual wires
- Four through mounting holes or optional metric threaded holes

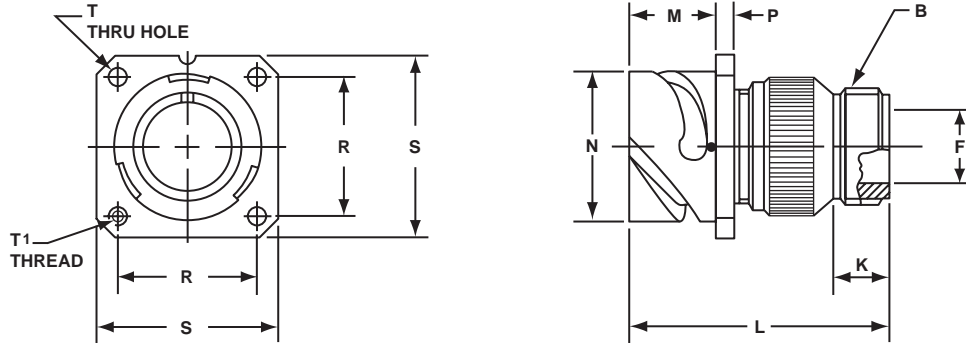

Inches

Shell Size	B Thread Class 2A	F Min.	K Min.	L Max.	M +.016 - .000	N +.000 - .006	P ±.008	R ±.004	S ±.012	T Thru Hole +.004 - .000
10SL	.6250-24 UNEF	.409	.374	1.969	.717	.717	.110	.717	1.000	.126
14S	.7500-20 UNEF	.520	.374	1.969	.717	.969	.126	.906	1.181	.126
16S	.8750-20 UNEF	.638	.374	1.969	.717	1.079	.126	.969	1.280	.126
16	.8750-20 UNEF	.638	.374	2.362	.846	1.079	.126	.969	1.280	.126
18	1.0000-20 UNEF	.756	.374	2.362	.907	1.213	.157	1.063	1.378	.126
20	1.1875-18 UNEF	.867	.374	2.362	.907	1.346	.157	1.157	1.496	.126
22	1.1875-18 UNEF	.965	.374	2.362	.907	1.472	.157	1.252	1.614	.126
24	1.4375-18 UNEF	1.094	.374	2.560	.907	1.610	.157	1.374	1.752	.146
28	1.4375-18 UNEF	1.228	.374	2.560	.947	1.839	.157	1.563	2.000	.146
32	1.7500-18 UNS	1.488	.433	2.560	.947	2.102	.157	1.752	2.244	.169
36	2.0000-18 UNS	1.780	.465	3.150	.947	2.346	.157	1.937	2.500	.169

Millimeters

Shell Size	F Min.	K Min.	L Max.	M + 0.4 - 0.0	N + 0.00 - 0.15	P ± 0.2	R ± 0.1	S ± 0.3	T Thru Hole + 0.1 - 0.0	T ¹ Metric Thread
10SL	10.4	9.5	50	18.2	18.2	2.8	18.2	25.4	3.2	M4
14S	13.2	9.5	50	18.2	24.6	3.2	23.0	30.0	3.2	M4
16S	16.2	9.5	50	18.2	27.4	3.2	24.6	32.5	3.2	M4
16	16.2	9.5	60	21.5	27.4	3.2	24.6	32.5	3.2	M4
18	19.2	9.5	60	23.0	30.8	4.0	27.0	35.0	3.2	M4
20	22.0	9.5	60	23.0	34.2	4.0	29.4	38.0	3.2	M4
22	24.5	9.5	60	23.0	37.4	4.0	31.8	41.0	3.2	M4
24	27.8	9.5	65	23.0	40.9	4.0	34.9	44.5	3.7	M4
28	31.2	9.5	65	24.1	46.7	4.0	39.7	50.8	3.7	M5
32	37.8	11.0	65	24.1	53.4	4.0	44.5	57.0	4.3	M5
36	45.2	11.8	80	24.1	59.6	4.0	49.2	63.5	4.3	M5

All dimensions for reference only.

ACA 3103E-B

wall mount receptacle for rear panel mounting

- Receptacle with cable clamp and telescopic bushing
- Includes grommet and grommet sleeve
- Four through mounting holes or optional metric threaded holes

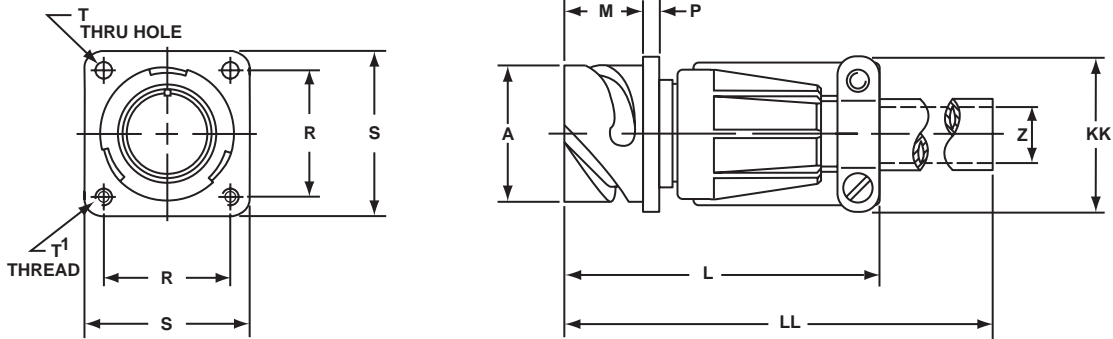

Inches

Shell Size	L Max.	M + .016 - .000	N + .000 - .006	P ± .008	R ± .004	S ± .012	T Thru Hole + .004 - .000	Z Max.	KK Max.	LL Max.
10SL	2.362	.717	.717	.110	.717	1.000	.126	.256	.894	4.720
14S	2.440	.717	.969	.126	.906	1.181	.126	.354	1.083	4.720
16S	2.756	.717	1.079	.126	.969	1.280	.126	.433	1.181	4.720
16	2.756	.846	1.079	.126	.969	1.280	.126	.433	1.181	4.921
18	3.031	.907	1.213	.157	1.063	1.378	.126	.559	1.300	4.921
20	3.031	.907	1.346	.157	1.157	1.496	.126	.622	1.476	4.921
22	3.031	.907	1.472	.157	1.252	1.614	.126	.622	1.476	4.921
24	3.346	.907	1.610	.157	1.374	1.752	.146	.843	1.705	4.921
28	3.346	.947	1.839	.157	1.563	2.000	.146	.843	1.705	4.921
32	3.346	.947	2.102	.157	1.752	2.244	.169	1.051	2.035	4.921
36	4.134	.947	2.346	.157	1.937	2.500	.169	1.248	2.283	5.315

Millimeters

Shell Size	L Max.	M + 0.4 - 0.0	N + 0.00 - 0.15	P ± 0.2	R ± 0.1	S ± 0.3	T Thru Hole + 0.1 - 0.0	T ¹ Metric Thread	Z Max.	KK Max.	LL Max.
10SL	60	18.2	18.2	2.8	18.2	25.4	3.2	M4	6.5	22.7	120
14S	62	18.2	24.6	3.2	23.0	30.0	3.2	M4	9.0	27.5	120
16S	70	18.2	27.4	3.2	24.6	32.5	3.2	M4	11.0	30.0	120
16	70	21.5	27.4	3.2	24.6	32.5	3.2	M4	11.0	30.0	125
18	77	23.0	30.8	4.0	27.0	35.0	3.2	M4	14.2	33.0	125
20	77	23.0	34.2	4.0	29.4	38.0	3.2	M4	15.8	37.5	125
22	77	23.0	37.4	4.0	31.8	41.0	3.2	M4	15.8	37.5	125
24	85	23.0	40.9	4.0	34.9	44.5	3.7	M4	21.4	43.3	125
28	85	24.1	46.7	4.0	39.7	50.8	3.7	M5	21.4	43.3	125
32	85	24.1	53.4	4.0	44.5	57.0	4.3	M5	26.7	51.7	125
36	105	24.1	59.6	4.0	49.2	63.5	4.3	M5	31.7	58.0	135

All dimensions for reference only.

ACA 3103G-B

wall mount receptacle for rear panel mounting

- Receptacle with endbell for heat shrink termination
- Does not include grommet and grommet sleeve
- Four through mounting holes or optional metric threaded holes

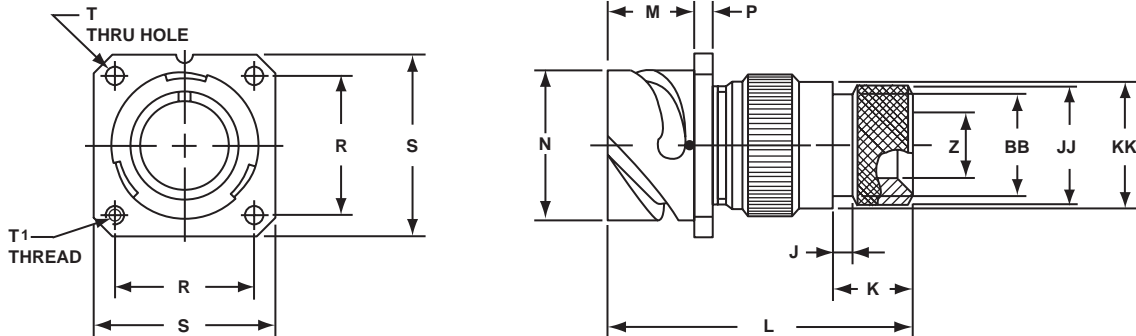

Inches

Shell Size	J ± .008	K ± .020	L Max.	M + .016 - .000	N + .000 - .006	P ± .008	R ± .004	S ± .012	T Thru Hole + .004 - .000	Z Min.	BB Max.	JJ ± .008	KK ± .008
10SL	.138	.461	1.969	.717	.717	.110	.717	1.000	.126	.303	.524	.610	.669
14S	.138	.461	1.969	.717	.969	.126	.906	1.181	.126	.417	.669	.752	.791
16S	.138	.461	1.969	.717	1.079	.126	.969	1.280	.126	.531	.862	.941	.925
16	.138	.453	2.362	.846	1.079	.126	.969	1.280	.126	.531	.862	.941	.925
18	.138	.453	2.362	.907	1.213	.157	1.063	1.378	.126	.575	.862	.941	1.043
20	.138	.500	2.559	.907	1.346	.157	1.157	1.496	.126	.736	1.031	1.165	1.189
22	.138	.500	2.559	.907	1.472	.157	1.252	1.614	.126	.819	1.031	1.165	1.323
24	.138	.500	2.559	.907	1.610	.157	1.374	1.752	.146	.969	1.358	1.488	1.421
28	.138	.500	2.559	.947	1.839	.157	1.563	2.000	.146	1.062	1.358	1.488	1.630
32	.138	.598	2.756	.947	2.102	.157	1.752	2.244	.169	1.311	1.717	1.882	1.913
36	.138	.598	3.150	.947	2.346	.157	1.937	2.500	.169	1.516	1.717	1.882	2.157

Millimeters

Shell Size	J ± 0.2	K ± 0.5	L Max.	M + 0.4 - 0.0	N + 0.00 - 0.15	P ± 0.2	R ± 0.1	S ± 0.3	T Thru Hole + 0.1 - 0.0	T ¹ Metric Thread	Z Min.	BB Max.	JJ ± 0.2	KK ± 0.2
10SL	3.5	11.7	50	18.2	18.2	2.8	18.2	25.4	3.2	M4	7.7	13.3	15.5	17.0
14S	3.5	11.7	50	18.2	24.6	3.2	23.0	30.0	3.2	M4	10.6	17.0	19.1	20.1
16S	3.5	11.7	50	18.2	27.4	3.2	24.6	32.5	3.2	M4	13.5	21.9	23.9	23.5
16	3.5	11.5	60	21.5	27.4	3.2	24.6	32.5	3.2	M4	13.5	21.9	23.9	23.5
18	3.5	11.5	60	23.0	30.8	4.0	27.0	35.0	3.2	M4	14.6	21.9	23.9	26.5
20	3.5	12.7	65	23.0	34.2	4.0	29.4	38.0	3.2	M4	18.7	26.2	29.6	30.2
22	3.5	12.7	65	23.0	37.4	4.0	31.8	41.0	3.2	M4	20.8	26.2	29.6	33.6
24	3.5	12.7	65	23.0	40.9	4.0	34.9	44.5	3.7	M4	24.6	34.5	37.8	36.1
28	3.5	12.7	65	24.1	46.7	4.0	39.7	50.8	3.7	M5	27.0	34.5	37.8	41.4
32	3.5	15.2	70	24.1	53.4	4.0	44.5	57.0	4.3	M5	33.3	43.6	47.8	48.6
36	3.5	15.2	80	24.1	59.6	4.0	49.2	63.5	4.3	M5	38.5	43.6	47.8	54.8

All dimensions for reference only.

ACA 3103R-B

wall mount receptacle for rear panel mounting

- Receptacle with short endbell for individual wire sealing
- Includes grommet and grommet sleeve
- Four through mounting holes or optional metric threaded holes

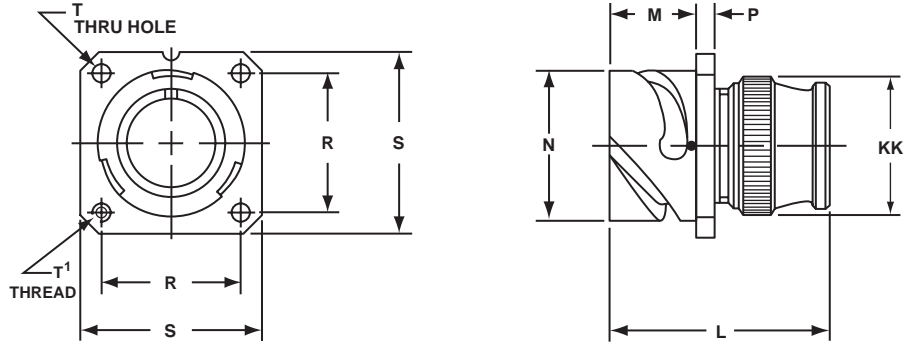

Inches

Shell Size	L Max.	M + .016 - .000	N + .000 - .006	P ± .008	R ± .004	S ± .012	T Thru Hole + .004 - .000	KK Max.
10SL	1.890	.717	.717	.110	.717	1.000	.126	.787
14S	1.890	.717	.969	.126	.906	1.181	.126	.945
16S	1.890	.717	1.079	.126	.969	1.280	.126	1.024
16	2.205	.846	1.079	.126	.969	1.280	.126	1.024
18	2.244	.907	1.213	.157	1.063	1.378	.126	1.161
20	2.244	.907	1.346	.157	1.157	1.496	.126	1.299
22	2.244	.907	1.472	.157	1.252	1.614	.126	1.417
24	2.244	.907	1.610	.157	1.374	1.752	.146	1.575
28	2.244	.947	1.839	.157	1.563	2.000	.146	1.811
32	2.362	.947	2.102	.157	1.752	2.244	.169	2.028
36	2.362	.947	2.346	.157	1.937	2.500	.169	2.283

Millimeters

Shell Size	L Max.	M + 0.4 - 0.0	N + 0.00 - 0.15	P ± 0.2	R ± 0.1	S ± 0.3	T Thru Hole + 0.1 - 0.0	T ¹ Metric Thread	KK Max.
10SL	48.0	18.2	18.2	2.8	18.2	25.4	3.2	M4	20.0
14S	48.0	18.2	24.6	3.2	23.0	30.0	3.2	M4	24.0
16S	48.0	18.2	27.4	3.2	24.6	32.5	3.2	M4	26.0
16	56.0	21.5	27.4	3.2	24.6	32.5	3.2	M4	26.0
18	57.0	23.0	30.8	4.0	27.0	35.0	3.2	M4	29.5
20	57.0	23.0	34.2	4.0	29.4	38.0	3.2	M4	33.0
22	57.0	23.0	37.4	4.0	31.8	41.0	3.2	M4	36.0
24	57.0	23.0	40.9	4.0	34.9	44.5	3.7	M4	40.0
28	57.0	24.1	46.7	4.0	39.7	50.8	3.7	M5	46.0
32	60.0	24.1	53.4	4.0	44.5	57.0	4.3	M5	51.5
36	60.0	24.1	59.6	4.0	49.2	63.5	4.3	M5	58.0

All dimensions for reference only.

ACA 3106F-B

straight plug

- Plug with backshell and rear accessory threads
- Includes grommet and grommet sleeve

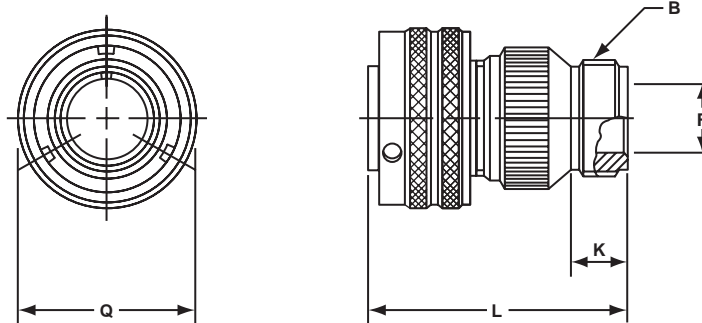

Inches

Shell Size	B Thread Class 2A	F Min.	K Min.	L Max.	Q Max.
10SL	.6250-24UNEF	.409	.374	1.969	.898
14S	.7500-20UNEF	.520	.374	1.969	1.150
16S	.8750-20UNEF	.638	.374	1.969	1.260
16	.8750-20UNEF	.638	.374	2.362	1.260
18	1.0000-20UNEF	.756	.374	2.362	1.437
20	1.1875-18UNEF	.867	.374	2.362	1.571
22	1.1875-18UNEF	.965	.374	2.362	1.697
24	1.4375-18UNEF	1.094	.374	2.560	1.835
28	1.4375-18UNEF	1.228	.374	2.560	2.102
32	1.7500-18UNS	1.488	.433	2.560	2.366
36	2.0000-18UNS	1.780	.465	3.150	2.610

Millimeters

Shell Size	F Min.	K Min.	L Max.	Q Max.
10SL	10.4	9.5	50	22.8
14S	13.2	9.5	50	29.2
16S	16.2	9.5	50	32.0
16	16.2	9.5	60	32.0
18	19.2	9.5	60	36.5
20	22.0	9.5	60	39.9
22	24.5	9.5	60	43.1
24	27.8	9.5	65	46.6
28	31.2	9.5	65	53.4
32	37.8	11.0	65	60.1
36	45.2	11.8	80	66.3

All dimensions for reference only.

ACA 3106E-B

straight plug

- Plug with cable clamp and telescopic bushing
- Includes grommet and grommet sleeve

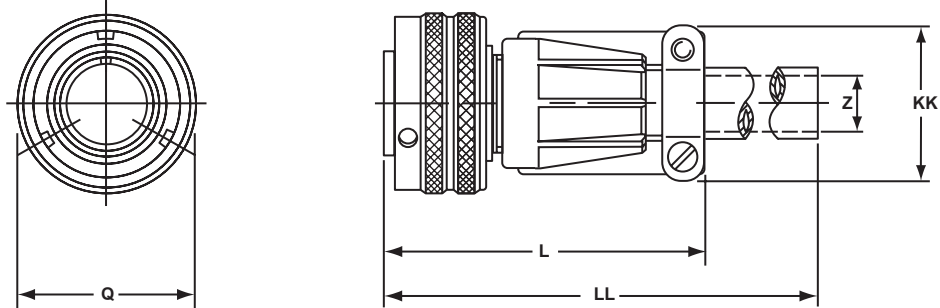

Inches

Shell Size	L Max.	Q Max.	Z Max.	KK Max.	LL Max.
10SL	2.165	.898	.256	.894	4.528
14S	2.362	1.150	.354	1.083	4.528
16S	2.362	1.260	.433	1.181	4.528
16	2.756	1.260	.433	1.181	4.724
18	2.756	1.437	.559	1.268	4.724
20	2.953	1.571	.622	1.476	4.724
22	2.953	1.697	.622	1.476	4.724
24	3.543	1.835	.843	1.705	4.724
28	3.543	2.102	.843	1.705	4.724
32	3.543	2.366	1.051	2.035	4.724
36	3.937	2.610	1.248	2.283	5.118

Millimeters

Shell Size	L Max.	Q Max.	Z Max.	KK Max.	LL Max.
10SL	55	22.8	6.5	22.7	115
14S	60	29.2	9.0	27.5	115
16S	60	32.0	11.0	30.0	115
16	70	32.0	11.0	30.0	120
18	70	36.5	14.2	32.2	120
20	75	39.9	15.8	37.5	120
22	75	43.1	15.8	37.5	120
24	90	46.6	21.4	43.3	120
28	90	53.4	21.4	43.3	120
32	90	60.1	26.7	51.7	120
36	100	66.3	31.7	58.0	130

All dimensions for reference only.

ACA 3106G-B

straight plug

- Plug with backshell for heat shrink termination
- Does not include grommet and grommet sleeve

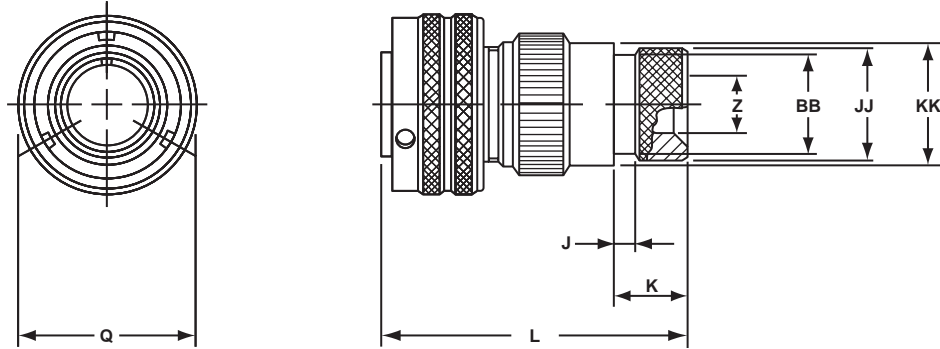

Inches

Shell Size	J ± .008	K ± .020	L Max.	Q Max.	Z Min.	BB Max.	JJ ± .008	KK ± .008
10SL	.138	.461	1.969	.898	.303	.524	.610	.669
14S	.138	.461	1.969	1.150	.417	.669	.752	.791
16S	.138	.461	1.969	1.260	.531	.862	.941	.925
16	.138	.453	2.362	1.260	.531	.862	.941	.925
18	.138	.453	2.362	1.437	.575	.862	.941	1.043
20	.138	.500	2.559	1.571	.736	1.031	1.165	1.189
22	.138	.500	2.559	1.697	.819	1.031	1.165	1.323
24	.138	.500	2.559	1.835	.969	1.358	1.488	1.421
28	.138	.500	2.559	2.102	1.063	1.358	1.488	1.630
32	.138	.598	2.756	2.366	1.311	1.717	1.882	1.913
36	.138	.598	3.150	2.610	1.516	1.717	1.882	2.157

Millimeters

Shell Size	J ± 0.2	K ± 0.5	L Max.	Q Max.	Z Min.	BB Max.	JJ ± 0.2	KK ± 0.2
10SL	3.5	11.7	50	22.8	7.7	13.3	15.5	17.0
14S	3.5	11.7	50	29.2	10.6	17.0	19.1	20.1
16S	3.5	11.7	50	32.0	13.5	21.9	23.9	23.5
16	3.5	11.5	60	32.0	13.5	21.9	23.9	23.5
18	3.5	11.5	60	36.5	14.6	21.9	23.9	26.5
20	3.5	12.7	65	39.9	18.7	26.2	29.6	30.2
22	3.5	12.7	65	43.1	20.8	26.2	29.6	33.6
24	3.5	12.7	65	46.6	24.6	34.5	37.8	36.1
28	3.5	12.7	65	53.4	27.0	34.5	37.8	41.4
32	3.5	15.2	70	60.1	33.3	43.6	47.8	48.6
36	3.5	15.2	80	66.3	38.5	43.6	47.8	54.8

All dimensions for reference only.

ACA 3106R-B

straight plug

- Plug with short endbell for individual wire sealing
- Includes grommet and grommet sleeve

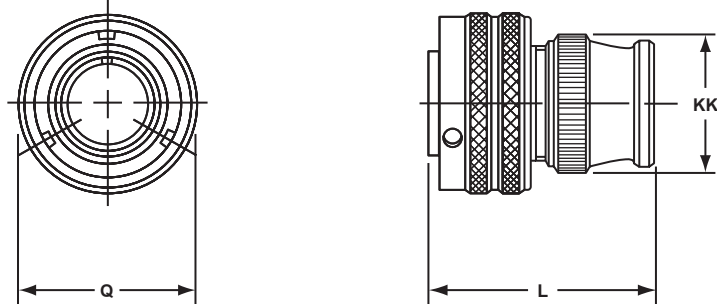

Inches

Shell Size	L Max.	Q Max.	KK Max.
10SL	1.417	.898	.787
14S	1.437	1.150	.945
16S	1.437	1.260	1.024
16	1.929	1.260	1.024
18	1.929	1.437	1.161
20	1.969	1.571	1.299
22	1.969	1.697	1.417
24	2.008	1.835	1.543
28	2.008	2.102	1.811
32	2.087	2.366	2.028
36	2.106	2.610	2.283

Millimeters

Shell Size	L Max.	Q Max.	KK Max.
10SL	36.0	22.8	20.0
14S	36.5	29.2	24.0
16S	36.5	32.0	26.0
16	49.0	32.0	26.0
18	49.0	36.5	29.5
20	50.0	39.9	33.0
22	50.0	43.1	36.0
24	51.0	46.6	40.0
28	51.0	53.4	46.0
32	53.0	60.1	51.5
36	53.5	66.3	58.0

All dimensions for reference only.

ACA 3107A-B

jam nut receptacle

- For rear panel single hole mounting
- Panel seal O-ring included
- Environment proof

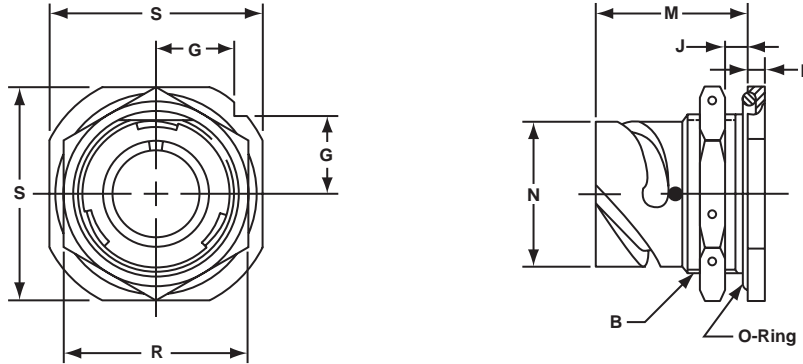

Inches

Shell Size	B Thread Class 2A	G ± .012	J Wall Thickness		M ± .012	N + .000 - .006	P ± .007	R ± .016	S ± .012
			Min.	Max.					
10SL	.8750-20 UNEF	.441	.094	.205	.965	.717	.157	1.062	1.252
14S	1.1250-18 UNEF	.575	.094	.295	1.055	.969	.189	1.312	1.626
16S	1.2500-18 UNEF	.618	.094	.295	1.055	1.079	.189	1.500	1.748
16	1.2500-18 UNEF	.618	.094	.295	1.264	1.079	.189	1.500	1.748
18	1.3750-18 UNEF	.661	.094	.354	1.327	1.213	.189	1.562	1.875
20	1.5000-18 UNEF	.709	.094	.358	1.327	1.346	.189	1.750	2.000
22	1.6250-18 UNEF	.795	.094	.358	1.327	1.472	.189	2.000	2.134
24	1.7500-18 UNEF	.795	.094	.358	1.327	1.610	.189	2.000	2.252
28	2.0000-18 UNS	.886	.094	.394	1.386	1.839	.220	2.188	2.500
32	2.2500-16 UN	.972	.094	.394	1.386	2.102	.220	2.438	2.748
36	2.5000-16 UN	1.059	.094	.327	1.386	2.346	.220	2.812	3.000

Millimeters

Shell Size	G ± 0.3	J Wall Thickness		M ± 0.3	N + 0.00 - 0.15	P ± 0.2	R ± 0.4	S ± 0.3
		Min.	Max.					
10SL	11.2	2.4	5.2	24.5	18.2	4.0	27	31.8
14S	14.6	2.4	7.5	26.8	24.6	4.8	33	41.3
16S	15.7	2.4	7.5	26.8	27.4	4.8	38	44.4
16	15.7	2.4	7.5	32.1	27.4	4.8	38	44.4
18	16.8	2.4	9.0	33.7	30.8	4.8	40	47.6
20	18.0	2.4	9.1	33.7	34.2	4.8	44	50.8
22	20.2	2.4	9.1	33.7	37.4	4.8	51	54.2
24	20.2	2.4	9.1	33.7	40.9	4.8	51	57.2
28	22.5	2.4	10.0	35.2	46.7	5.6	56	63.5
32	24.7	2.4	10.0	35.2	53.4	5.6	62	69.8
36	26.9	2.4	8.3	35.2	59.6	5.6	71	76.2

All dimensions for reference only.

ACA 3108F-B

90° angle plug

- 90° plug for angled attachment to panels with rear accessory threads
- Includes grommet and grommet sleeve

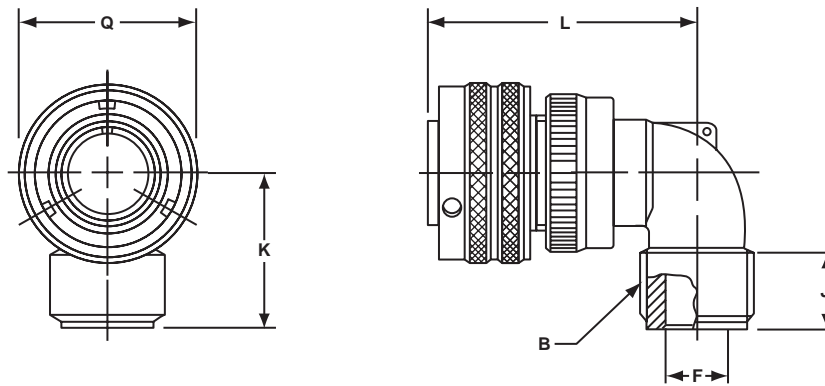

Inches

Shell Size	B Thread Class 2A	F Max.	J Min.	K Max.	L Max.	Q Max.
10SL	.6250-24UNEF	.337	.370	1.181	1.772	.898
14S	.7500-20UNEF	.462	.370	1.181	1.850	1.150
16S	.8750-20UNEF	.587	.370	1.181	1.890	1.299
16	.8750-20UNEF	.587	.370	1.181	2.244	1.299
18	1.0000-20UNEF	.685	.370	1.378	2.283	1.437
20	1.1875-18UNEF	.810	.370	1.378	2.402	1.571
22	1.1875-18UNEF	.915	.370	1.378	2.402	1.697
24	1.4375-18UNEF	1.025	.370	1.575	2.598	1.835
28	1.4375-18UNEF	1.139	.370	1.575	2.598	2.102
32	1.7500-18UNS	1.447	.433	1.772	2.835	2.366
36	2.0000-18UNS	1.687	.496	1.969	2.953	2.610

Millimeters

Shell Size	F Max.	J Min.	K Max.	L Max.	Q Max.
10SL	8.5	9.4	30	45	22.8
14S	11.7	9.4	30	47	29.2
16S	14.9	9.4	30	48	33.0
16	14.9	9.4	30	57	33.0
18	17.4	9.4	35	58	36.5
20	20.5	9.4	35	61	39.9
22	23.2	9.4	35	61	43.1
24	26.0	9.4	40	66	46.6
28	28.9	9.4	40	66	53.4
32	36.7	11.0	45	72	60.1
36	42.8	12.6	50	75	66.3

All dimensions for reference only.

ACA 3108E-B

90° angle plug

- 90° plug for angled attachment to panels with cable clamp and telescopic bushing
- Includes grommet and grommet sleeve

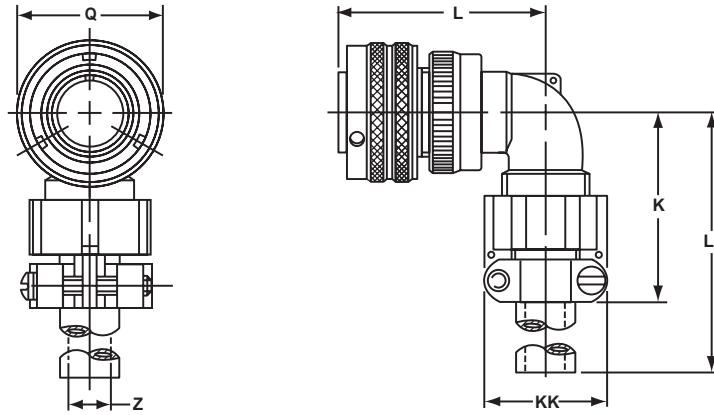

Inches

Shell Size	K Max.	L Max.	Q Max.	Z Max.	KK Max.	LL Max.
10SL	1.654	1.772	.898	.220	.894	3.937
14S	1.654	1.850	1.150	.312	1.083	3.937
16S	1.772	1.890	1.299	.437	1.181	3.937
16	1.772	2.244	1.299	.437	1.181	3.937
18	2.087	2.283	1.437	.562	1.299	3.937
20	2.087	2.402	1.571	.625	1.476	3.937
22	2.087	2.402	1.697	.625	1.476	3.937
24	2.283	2.598	1.835	.750	1.705	3.937
28	2.283	2.598	2.102	.750	1.705	3.937
32	2.598	2.835	2.366	.937	2.061	4.331
36	2.717	2.953	2.610	1.250	2.283	4.331

Millimeters

Shell Size	K Max.	L Max.	Q Max.	Z Max.	KK Max.	LL Max.
10SL	42	45	22.8	5.58	22.7	100
14S	42	47	29.2	7.92	27.5	100
16S	45	48	33.0	11.09	30.0	100
16	45	57	33.0	11.09	30.0	100
18	53	58	36.5	14.27	33.0	100
20	53	61	39.9	15.87	37.5	100
22	53	61	43.1	15.87	37.5	100
24	58	66	46.6	19.05	43.3	100
28	58	66	53.4	19.05	43.3	100
32	66	72	60.1	23.79	51.7	110
36	69	75	66.3	31.75	58.0	110

All dimensions for reference only.

ACA-B Connectors – accessories

10-40450, 10-36675, 10-580649 sealing gaskets

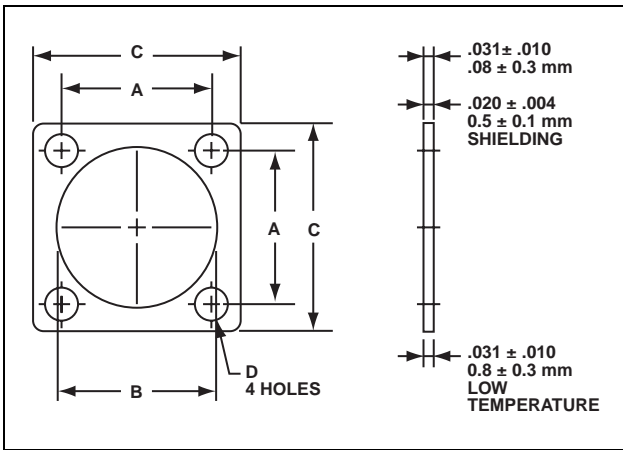

PLAIN FLAT GASKET

The Amphenol® plain flat gasket of synthetic rubber material is provided to take complete advantage of waterproof and pressure sealing features. It is for use with the flange mounted receptacle.

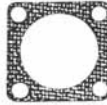

SHIELDING GASKET

This flat gasket is provided to give the maximum in connector performance. Its special feature is in providing the maximum radio shielding under difficult conditions of high receiver sensitivity and low signal strength while retaining the sealing characteristics of the plain gasket. This gasket is for use with the flange mounting receptacle.



LOW TEMPERATURE GASKET

This gasket is provided for applications where the major requirement is resistance to the injurious effects of extremely low temperature. Even at temperatures as low as -67°F this gasket retains its resiliency and will seal a pressure differential of 30 psi.

Additional versions of gaskets are available including low smoke zero halogen, and also high temperature and conductive types. Consult Amphenol Industrial Operations, Sidney NY, for further information.

Installation Dimensions					
MS Shell Size	A $\pm .010$	Front Panel Versions B $+ .016$ $- .000$	Rear Panel Version B $+ .016$ $- .000$	C $+ .016$ $- .000$	D $\pm .010$
10SL	.719	.625	.724	1.000	.172
14S	.906	.875	.976	1.188	.172
16S	.969	1.000	1.087	1.281	.172
16	.969	1.000	1.087	1.281	.172
18	1.063	1.125	1.220	1.375	.203
20	1.156	1.250	1.354	1.500	.203
22	1.250	1.375	1.480	1.625	.203
24	1.375	1.500	1.618	1.750	.203
28	1.563	1.750	1.846	2.000	.203
32	1.750	2.000	2.110	2.250	.219
36	1.938	2.188	2.354	2.500	.219

Order Data for Front Panel Mount Gaskets			
Front Panel Plain Version	Front Panel Shielding Version	Front Panel Low Temperature Version	Front Panel Low Smoke ZH Version
10-40450-10	10-40450-10S	10-36675-10	LS-40450-10
10-40450-14	10-40450-14S	10-36675-14	LS-40450-14
10-40450-16	10-40450-16S	10-36675-16	LS-40450-16
10-40450-18	10-40450-18S	10-36675-18	LS-40450-18
10-40450-20	10-40450-20S	10-36675-20	LS-40450-20
10-40450-22	10-40450-22S	10-36675-22	LS-40450-22
10-40450-24	10-40450-24S	10-36675-24	LS-40450-24
10-40450-28	10-40450-28S	10-36675-28	LS-40450-28
10-40450-32	10-40450-32S	10-36675-32	LS-40450-32
10-40450-36	10-40450-36S	10-36675-36	LS-40450-36
10-40450-40	10-40450-40S	10-36675-40	LS-40450-40

Installation Dimensions					
MS Shell Size	A ± 0.2	Front Panel Versions B $+ 0.4$ $- 0.0$	Rear Panel Version B $+ 0.4$ $- 0.0$	C $+ 0.4$ $- 0.0$	D ± 0.2
10SL	18.2	15.9	18.4	25.4	4.36
14S	23.0	22.2	24.8	30.2	4.36
16S	24.6	25.4	27.6	32.5	4.36
16	24.6	25.4	27.6	32.5	4.36
18	27.0	28.57	31.0	35.0	5.15
20	29.4	31.75	34.4	38.1	5.15
22	31.8	34.9	37.6	41.2	5.15
24	34.9	38.1	41.1	44.5	5.15
28	39.7	44.45	46.9	50.8	5.15
32	44.5	50.8	53.6	57.2	5.56
36	49.2	55.57	59.8	63.5	5.56

Order Data for Rear Panel Mount Gaskets	
Rear Panel Plain Version	Rear Panel Low Smoke ZH Version
10-580649-11	LS-580649-11
10-580649-14	LS-580649-14
10-580649-16	LS-580649-16
10-580649-18	LS-580649-18
10-580649-20	LS-580649-20
10-580649-22	LS-580649-22
10-580649-24	LS-580649-24
10-580649-28	LS-580649-28
10-580649-32	LS-580649-32
10-580649-36	LS-580649-36
10-580649-40	LS-580649-40

ACA-B Connectors – accessories

receptacle protection caps

- Protective metal caps which seal the front of receptacles
- Includes a chain for retention of the cap at the required location
- For all ACA()-B receptacles

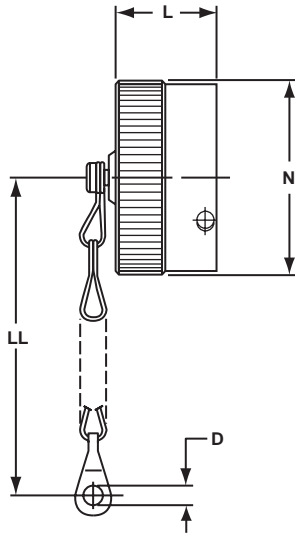

* 10-580902-XXX

* To complete order number, add shell size and suffix number. For example, shell size 11 with olive drab cadmium plate would be 10-580902-113.

Inches

Shell Size	D + .020 - .000	L Max.	N Max.	LL Approx.
10SL	.173	.700	.905	5.000
14S	.173	.700	1.181	5.000
16	.173	.700	1.280	5.000
17	.173	.900	1.280	5.000
18	.173	.900	1.457	5.000
20	.173	.900	1.594	5.000
22	.173	.900	1.713	5.000
24	.173	.900	1.850	5.000
28	.220	.900	2.126	7.480
32	.261	.900	2.382	7.480
36	.261	.900	2.638	7.480

Millimeters

Shell Size	D + 0.5 - 0.0	L Max.	N Max.	LL Approx.
10SL	4.4	17.8	23.0	127
14S	4.4	17.8	30.0	127
16	4.4	17.8	32.5	127
17	4.4	22.9	32.5	127
18	4.4	22.9	37.0	127
20	4.4	22.9	40.5	127
22	4.4	22.9	43.5	127
24	4.4	22.9	47.0	127
28	5.6	22.9	54.0	190
32	5.6	22.9	60.5	190
36	5.6	22.9	67.0	175

All dimensions for reference only.

Finish	Suffix
Olive drab cadmium plate	-XX3
Electroless nickel	-XXG
Black zinc cobalt	-XXY

ACA-B Connectors – accessories

plug protection caps

- Protective metal caps which seal the front of plugs
- Includes a chain for retention of the cap at the required location
- For all ACA()-B plugs

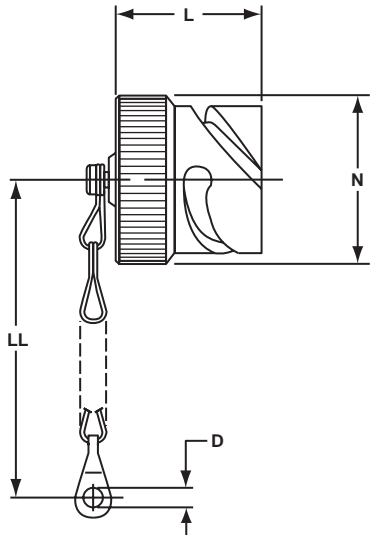

* 10-580903-XXX

* To complete order number, add shell size and suffix number. For example, shell size 11 with olive drab cadmium plate would be 10-580903-113.

Inches

Shell Size	D + .020 - .000	L Max.	N Max.	LL Approx.
10SL	.157	.945	.807	5.000
14S	.157	.945	1.059	5.000
16	.157	.945	1.169	5.000
17	.157	.945	1.169	5.000
18	.157	.945	1.303	5.000
20	.189	1.260	1.437	5.520
22	.189	1.260	1.563	5.520
24	.189	1.260	1.701	5.520
28	.220	1.260	1.929	7.480
32	.261	1.260	2.193	7.480
36	.261	1.260	2.437	7.480

Millimeters

Shell Size	D + 0.5 - 0.0	L Max.	N Max.	LL Approx.
10SL	4.0	24	20.5	127
14S	4.0	24	26.9	127
16	4.0	24	29.7	127
17	4.0	24	29.7	127
18	4.0	24	33.1	127
20	4.8	32	36.5	140
22	4.8	32	39.7	140
24	4.8	32	43.2	140
28	4.8	32	49.0	190
32	5.6	32	55.7	190
36	5.6	32	61.9	190

All dimensions for reference only.

Finish	Suffix
Olive drab cadmium plate	-XX3
Electroless nickel	-XXG
Black zinc cobalt	-XXY

ACA-B Connectors – accessories

rear mounting data, panel cut-out dimensions, sealing plugs, sealing ranges

REAR MOUNTING DATA MAXIMUM PANEL THICKNESS

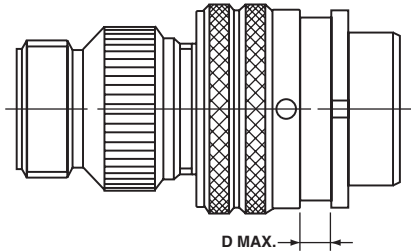

Size	Dimension D			
	GT00/020		GT030	
	Inches	(mm)	Inches	(mm)
10SL	.146	3.70	.303	7.70
14S	.146	3.70	.303	7.70
16S	.146	3.70	.303	7.70
16	.145	3.70	.242	6.15
18	.145	3.70	.303	7.70
20	.145	3.70	.303	7.70
22	.145	3.70	.303	7.70
24	.207	5.25	.303	7.70
28	.207	5.25	.343	8.70
32	.241	6.10	.309	7.85
36	.241	6.10	.309	7.85

GROMMET HOLE SEALING RANGES

Hole Size	Sealing Range	
	(mm)	Inches
16	1.62 – 3.3	.064 – .130
12	2.89 – 4.31	.114 – .170
8	4.16 – 6.47	.164 – .255
4	6.9 – 9.3	.272 – .370
0	10.5 – 13.97	.415 – .550

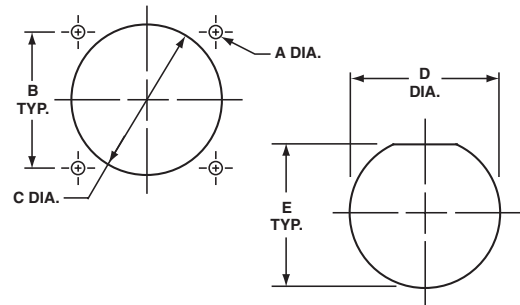

PANEL CUT-OUT DIMENSIONS

SEALING PLUG 10-405996-XX

Sealing plugs are used to fill unused holes in multi-holed grommet configurations.

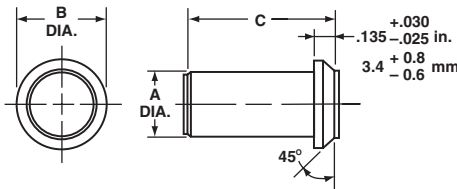

Order No.	Contact Size	Wire Size	Color Code	Inches		
				A Dia. ±.010	B ±.005	C ±.010
10-405996-16	16	20-16	Blue	.083	.133	.564**
10-405996-12	12	14-12	Yellow	.121	.171	.564**
10-405996-8	8	10-8	Red	.185	.315	.470
10-405996-4	4	4-6	Blue	.310	.415	.470
10-405996-0	0	0-2	Yellow	.440	.605	1.000

Millimeters		
A Dia. ± 0.2	B ± 0.1	C ± 0.2
2.1	3.4	14.3***
3.1	4.3	14.3***
4.7	8.0	11.9
7.9	10.5	11.9
11.2	15.4	25.4

** ± .020 (in.) *** ± 0.5 (mm)

Shell Size	A Dia. Hole Size	Connector Styles				
		02, 020, 00, 030 B ±.004	Front Mount 02, 00, 020 C Dia.	Rear Mount 030 C Dia.	Jam Nut 070 D Dia.	Jam Nut 070 E
10SL	.126	.717	11/16	1 3/4	7/8	.83
14S	.126	.906	13/16	1	1 1/8	1.08
16S/16	.126	.969	15/16	1 1/8	1 1/14	1.21
18	.126	1.063	1 1/16	1 1/4	1 3/8	1.32
20	.126	1.157	1 3/16	1 3/8	1 1/2	1.45
22	.126	1.252	1 5/16	1 1/2	1 5/8	1.57
24	.146	1.374	1 7/16	1 5/8	1 3/4	1.70
28	.146	1.563	1 11/16	1 7/8	2	1.95
32	.169	1.752	1 15/16	2 1/8	2 1/4	2.20
36	.169	1.937	2 1/8	2 3/8	2 1/2	2.45

All dimensions for reference only.

ACA-B Connectors – accessories

crimp contacts and application tools

Contacts for ACA-B connectors are machined from copper alloys and silver plated for maximum corrosion resistance, with a minimum millivolt drop and a maximum current carrying capacity; the size 16 and 12 socket contacts are of the closed entry design.

CRIMP CONTACTS

CRIMP CONTACT DATA				APPLICATION TOOLS								
PART NUMBER				MATING SIZE	WIRE WELL	Crimp Tools	Positioner/ Die Set	Locator/ Color				
PIN CONTACT		SOCKET CONTACT										
SILVER	GOLD("D")	SILVER	GOLD("D")									
10-40553	10-597160-15D	10-597109-161	10-597109-16D	16S	16-18-20	Daniels AF8 or Equivalent	TH29-1 or Equivalent	Red				
10-606014-40	10-597160-40D	10-597109-401	10-597109-40D		12-14							
10-606014-221	10-597160-19D	10-597109-191	10-597109-19D		14-16							
10-606014-291	10-597160-34D	10-597109-341	10-597109-34D		20-22							
10-606014-46	10-597160-46D	10-597109-461	10-597109-46D		20-24							
10-40557	10-597160-16D	10-597109-171	10-597109-17D	16	16-18-20			Daniels AF8 or Equivalent	TH29-1 or Equivalent	Pin - Blue Socket - Green		
10-606014-022	10-597160-22D	10-597109-221	10-597109-22D		12-14							
10-606014-171	10-597160-17D	10-597109-141	10-597109-14D		14-16							
10-606014-311	10-597160-33D	10-597109-331	10-597109-33D		20-22							
10-606014-361	10-597160-36D	10-597109-361	10-597109-36D	20-24								
10-606014-121	10-597160-12D	10-597109-131	10-597109-13D	12	12-14					Daniels AF8 or Equivalent	TH29-1 or Equivalent	Green
10-606014-231	10-597160-23D	10-597109-231	10-597109-23D		8-10							
10-606014-251	10-597160-26D	10-597109-261	10-597109-26D		10-12							
10-606014-271	10-597160-27D	10-597109-271	10-597109-27D		14-16-18							
10-606014-261	10-597160-24D	10-597109-241	10-597109-24D		18-20							
10-606014-201	10-597160-20D	10-597109-201	10-597109-20D		20-22							
10-40792	10-597160-8D	10-40793	10-597109-8D	8	8	Pico 400BHD	Pico 414DA-8N					Pico Pin - 4025 Socket - 4026
10-606014-41	10-597160-41D	10-597109-411	10-597109-41D		6							
10-606014-321	10-597160-28D	10-606015-321	10-597109-28D		10-12							
10-606014-381	10-597160-38D	10-597109-381	10-597109-38D		12-14							
10-40564	10-597160-4D	10-40565	10-597109-4D	4	4		Pico 400BHD	Pico 414DA-4N	Pico 4043			
10-606014-58	10-597160-58D	10-597109-581	10-597109-58D		6							
10-606014-331	10-597160-35D	10-597109-351	10-597109-35D		8							
10-606014-44	10-597160-44D	10-606015-441	10-597109-44D		10							
10-581806-000	10-597160-1D	10-581808-000	10-597159-1D	0	0			Pico 400BHD	Pico 414DA-0N			Pico Pin - 4042-1 Socket - 4042
10-606014-341	10-597160-29D	10-597109-291	10-597109-29D		0-2							
10-606014-351	10-597160-30D	10-606015-351	10-597109-30D		4							
10-597276-48	10-597276-48D	10-606015-48	10-597109-48D	2/0	2/0				Pico 500	Pico 514DA2/0N	Pico Pin - 6490	
10-597276-47	10-597276-47D	10-606015-47	10-597109-47D	4/0	4/0					Pico 514DA4/0N	Socket - 6491	

See page 52 for further contact information applicable to both crimp and solder contacts.

Additional contact variations including thermocouple and RADSOK® power contacts are available; consult Amphenol Industrial, Sidney, NY for information.

ACA-B Connectors – accessories

application tools

When proprietary crimp contacts are employed rather than the standard MS approved solder contacts, the following application tools are recommended for use. There is a possibility of additional crimping tools other than those included being available at present or in the future for this specific application.

Complete instructions for providing reliable crimped wire to contact terminations and inserting proprietary crimp contacts in ACA-B series connectors are available in publication L-757.

TOOLING CHART

Contact Size	Contact Style	Insertion Tool	Removal Tool
16	Pin & Socket	11-7345	11-8250 Kit
12	Pin & Socket	11-7082	11-8250 Kit
8	Pin & Socket	11-8220	11-8250 Kit
4	Pin & Socket	11-7365-4†	Pin 11-7370-4† Socket 11-7674-2†
0	Pin & Socket	11-7365-5†	Pin 11-7370-5† Socket 11-7674-3†

*Use Daniels Turret TH29-1 or Astro Tool Co. Turret 616266

**For appropriate crimp tool and positioner refer to Pico Crimping Tool Co.

†Tools used with Arbor press 11-7364

ACA-B Connectors – accessories

solder contacts

Machined copper alloy contacts in a full range of sizes, with closed entry socket design in the size 12 and 16 contacts. A heavy silver-plated finish is deposited on all MS style solder contacts for maximum corrosion resistance, maximum current carrying capacity and low millivolt drop. (See how to order, Connector Modification, page 53).

Part Number	Pin/Socket	Mating End Size	Wire Barrel Size	Allowable Wire Size	Test Current** Amps
10-040569-000	Pin	16 Short†	16	16	13
10-597107-171	Socket			18	10
				20	7.5
				22	5
10-040599-000	Pin	16 Long	16	16	13
10-597107-171	Socket			18	10
				20	7.5
				22	5
10-033646-000	Pin	12	12	12	23
10-597107-131	Socket			14	17
10-035531-000	Pin	8	8	8	46
10-035532-000	Socket			10	33
10-035529-000	Pin	4	4	4	80
10-035530-000	Socket			6	60
10-035527-000	Pin	0	0	0	150
				1	125
10-035528-000	Socket			2	100

** Contact ratings as stated are test ratings only. The connector may not withstand full rated current through all contacts continuously. Please note that the electrical data given is not an establishment of electrical safety factors. This is left entirely in the designer's hands as he can best determine which peak voltage, switching surges, transients, etc. can be expected in a particular circuit.

† The 10SL, 14S and 16S connectors require short contacts.

Table I
MIL-SPEC CONTACT ARRANGEMENT SERVICE RATING

MS Service Rating	Recommended Operating Voltage* at Sea Level		Effective Creepage Distance Nom.	Mechanical Spacing Nom.
	DC	AC (RMS)		
Inst.	250	200	1/16	
A	700	500	1/8	1/16
D	1250	900	3/16	1/8
E	1750	1250	1/4	3/16
B	2450	1750	5/16	1/4
C	4200	3000	1	5/16

* The values listed in Table I represent operating values which include a generous safety factor. It may be necessary for some applications to exceed the operating voltages listed here. If this is necessary, designers will find Table II useful for determining the degree to which the recommended values of Table I can be exceeded.

Table II
ALTITUDE VOLTAGE DERATING CHART**

MS Service Rating	Nominal Distance		Standard Sea Level Conditions		Pressure Altitude † 50,000 Feet		Pressure Altitude † 70,000 Feet	
	Airspace	Creepage	Minimum Flashover Voltage AC (RMS)	Test Voltage AC (RMS)	Minimum Flashover Voltage AC (RMS)	Test Voltage AC (RMS)	Minimum Flashover Voltage AC (RMS)	Test Voltage AC (RMS)
Inst.	1/32	1/16	1400	1000	550	400	325	260
A	1/16	1/8	2800	2000	800	600	450	360
D	1/8	3/16	3600	2800	900	675	500	400
E	3/16	1/4	4500	3500	1000	750	550	440
B	1/4	5/16	5700	4500	1100	825	600	480
C	5/16	1	8500	7000	1300	975	700	560

† Not corrected for changes in density due to variations in temperature

** No attempt has been made to recommend operating voltages. The designer must determine his own operating voltage by the application of a safety factor to the above derating chart to compensate for circuit transients, surges, etc.

Amphenol® ACA-B Connectors

how to order, connector intermateability

Part Number System (example part number shown)							
ACA	3100	E	10SL-3	P	W	B	(F80)
1	2	3	4	5	6	7	8

1. Connector Series

ACA designates Amphenol® ACA-B Reverse Bayonet Series

2. Shell Style

- 3100 - Wall mount receptacle for front panel mounting
- 3101 - Cable connecting receptacle
- 3102 - Box mount receptacle (Class E only, see sect. 3)
- 3103 - Wall mount receptacle for rear panel mounting
- 3106 - Straight plug
- 3107 - Jam nut receptacle - rear panel mount
(Class A only, see sect. 3)
- 3108 - 90° angle plug

3. Connector Class

- A Environmental, no rear threads (Applies to 3107 only)
- E Environmental resisting, with grommet seal and strain relief backshell
- F Environmental resisting, with grommet seal and solid backshell with rear accessory threads
- G Backshell for heat shrink termination
- R Environmental resisting with lightweight endbell

4. Shell Size and Insert Arrangement

See pages 2-4 for insert availability charts, and pages 6-24 for insert pattern drawings.

5. Contact Style

P designates pin contacts
S designates socket contacts
Note: standard contacts are silver plated. Consult Connector Modification for ordering gold plated contacts.

6. Alternate Position

W, X, Y and Z - See page 5.
No suffix required for normal position.

7. Designation for Reverse Bayonet

B designates Reverse Bayonet coupling shells

8. Connector Modification

Omit for standard olive drab connectors with solder type silver plated contacts.

For a modification as listed below, add suffix in parenthesis to the end of the part number. Consult Amphenol Industrial Operations for further description or assistance.

- (RDS) with Radsock contacts
- (F80) with AWG crimp contacts
- (FO) less contacts. (contacts are to be ordered separately)
- (A176) gold contacts
- (T00) metric threads in flange holes
- (RFI) grounded - plug only
- (F42) less grommet and backshell
- (F85) less sleeve and grommet
- (A23) electroless nickel plating
- (A232) with black zinc cobalt plating

MATEABILITY WITH IDENTICAL CONTACT ARRANGEMENTS

Connector Style	Mateable with Style
ACA3100	ACA 3106, 3108
ACA3101	ACA 3106, 3108
ACA3102	ACA 3106, 3108
ACA3103	ACA 3106, 3108
ACA3106	ACA 3100, 3101, 3102, 3103, 3107
ACA3107	ACA 3106, 3108
ACA3108	ACA 3100, 3101, 3102, 3103, 3107

This catalog is on the Amphenol website:
www.amphenol-industrial.com.

See www.amphenol-industrial.com and www.amphenol-aerospace.com for the broad range of interconnection products offered by Amphenol.

Amphenol Corporation
Amphenol Aerospace
Amphenol Industrial Operations
40-60 Delaware Avenue
Sidney, NY 13838-1395
Phone:607-563-5011
1-800-678-0141
Fax: 607-563-5157
Web: www.amphenol-aerospace.com
Web: www.amphenol-industrial.com

SALES OFFICES
Amphenol Corporation
Amphenol Aerospace
Amphenol Industrial Operations
23276 South Pointe Drive
Suite 113
Laguna Hills, CA 92653
Phone:949-855-4454
1-800-678-0141
Fax: 949-855-9115

Amphenol Corporation
Amphenol Aerospace
Amphenol Industrial Operations
2010 Corporate Ridge
McLean, VA 22101
Phone:1-800-678-0141

Amphenol Industrial Operations
Amphenol Power Solutions
34190 Riviera Drive
Fraser, MI 48026
Phone: 586-294-7400
Fax: 586-294-7402
www.radsok.com

Amphenol Pcd
72 Cherry Hill Drive
Beverly, MA 01915
Phone: 978-532-8800
Fax: 978-532-6800
Web: www.amphenolpcd.com

Advanced Circuit Technology
118 Northeastern Boulevard
Nashua, NH 03062
Phone: 603-880-6000
Fax: 603-880-1785
Web: www.act.flexcircuit.com

Amphenol Canada Corp.
605 Milner Ave.
Toronto, Ontario M1B 5X6
Canada
Phone:416-291-4401
Fax: 416-292-0647
Web: www.amphenolcanada.com

AUTHORIZED AMPHENOL DISTRIBUTORS
Corporate Headquarters
ALPHABETICAL LISTING
APD (All Product Distributors):
Arrow Electronics Englewood, CO
800-777-2776
www.arrow.com

Avnet EMG Dallas, TX
800-332-8638
www.avnet.com

PEI Genesis Philadelphia, PA
888-642-8750
www.peigenesis.com

Powell Electronics Logan Township, NJ
800-235-7880
www.powell.com

TTI Inc. Fort Worth, TX
800-225-5884
www.ttiinc.com

AUTHORIZED AMPHENOL INDUSTRIAL DISTRIBUTORS
Corporate Headquarters
ALPHABETICAL LISTING

Argo International New Orleans, LA
Phone: 504-733-4500 or 800-242-2746
www.argointl.com

Gaffney-Kroese Electric Rahway, NJ
Phone: 732-850-4418
www.gaffney-kroese.com

Geophysical Electrical Supply Co. Houston, TX
Phone:713-645-5999
www.geosco.com

Hillcrest Enterprises Ashland, VA
Phone: 800-848-3106 or 804-798-8390
www.hillcrestenterprises.com

ITI Marine & Oilfield PTE, Ltd. Singapore
Phone: (65) 6266-6666
www.itimarine.com

Norton Electric Wholesale Los Angeles, CA
Phone: 323-222-7181
www.nortonelectric.com

Offshore Marine Houston, TX
Phone: 800-506-9473
www.amercable.com

PEI Genesis Hampshire, UK
Phone: 44 8707 202560

Steck Connections Ontario, Canada
Phone: 905-608-2444
www.steckconnections.com

Steiner Electric Elk Grove Village, IL
Phone: 847-956-3700
www.steinerelectric.com

Technor ASA Stavanger, Norway
Phone: 47 51 84 4100
www.technor.no

Wholesale Electric Houston, TX
Phone: 713-748-6100
www.whoaleelectric.com

Disadvantaged/Minority Distributors:
Cherokee Nation Dist. Stilwell, OK
918-696-2777

Electro Enterprises Oklahoma City, OK
800-324-6591

JRH Electronics Marlton, NJ
800-467-9309

INTERNATIONAL
Latin America
ARGENTINA
Amphenol Argentina
Avenida Callao 930
2nd floor Office B Plaza
C1023AAP Buenos Aires, Argentina
Phone: (54 11) 48 15 68 86
Fax: (54 11) 48 14 57 79
E-mail: ventas@amphenol.com.ar

BRAZIL
Amphenol do Brasil Ltda.
Rua Diogo Moreira 132
CEP 05423-010
Sao Paulo - SP, Brazil
Phone: (55-11) 3815.1003
Fax: (55-11) 3815.1629
E-mail: vendas@amphenol.com.br

MEXICO
Amphenol Mexico
Prolongacion Reforma 61-6 B2
Col. Paseo de las Lomas
C.P. 01330 Mexico D.F., Mexico
Phone: (52-55) 5258.9984
Fax: (52-55) 5081.6890
E-mail: info@amphenolmexico.com

Europe
ENGLAND
Amphenol Limited
Thanet Way, Whitstable
Kent CT5 3JF, United Kingdom
Phone: (44-1-227) 773200
Fax: (44-1-227) 276571
Web: www.amphenol.co.uk

FRANCE
Amphenol Socapex
Promenade de l'Arve, BP29
Thyze 74301 948 Cedex, France
Phone: (33-4) 50892800
Fax: (33-4) 5096-1941
Web: www.amphenol-socapex.com

GERMANY
Amphenol-Tuchel Elect. GmbH
August-Haeusser Strasse 10
Postfach 1110
74001 Heilbronn, Germany
Phone: (49-7131) 929 0
Fax: (49-7131) 929 414
Web: www.amphenol-tuchel.com

GERMANY
Amphenol-Air LB GmbH
Am Kleinbahnhof 4
D-66740 Saarbrücken, Germany
Phone: (49-6831) 9810-87
Fax: (49-6831) 9810-30
Web: www.amphenol-airlb.com

ITALY & REST OF EUROPE
Amphenol Italia S.p.A.
Via Barbaiana 5
20020 Lainate (Milano), Italy
Phone: 39-02-932541
Fax: 39-02-93254444
E-mail: info@amphenol-it.com

Middle East / Africa
ISRAEL
Bar-Tec Ltd.
3 Hagavish St., P.O.B. 279
Kfir-Barkan Bldg., East Indust. Zone
Kfar Sava 44102, Israel
Phone: (972-9) 764.4100
Fax: (972-9) 7674324
E-mail: www.bar-tec.com

SOUTH AFRICA
Amphenol South Africa
30 Impala Road
2196 Sandton - Chislehurst
South Africa
Tel: (27-11) 783-9517
Fax: (27-11) 783-9519
E-mail: amphenol_africa@csi.com

TURKEY
Amphenol Turkiye
Ayazaga Mah. Meydan Sk. No. 28
Beybi Giz Plaza, Kat. 26 Maslak
34396 Istanbul
Phone: 90 (212) 335 25 01
Fax: 90 (212) 335 25 00
Web:www.amphenol.com.tr
E-mail: saracolglu@amphenol.com.tr

Asia / Pacific
AUSTRALIA
Amphenol Australia Pty Ltd
2 Fiveways Blvd. Keysborough
Melbourne, Victoria 3173
Australia
Phone: 613 8796 8888
Fax: 613 8796 8801
E-mail: info@amphenol.com.au

RUSSIA
Amphenol Russia Office
8-2 Yaroslavskaja Str.
129164 Moscow, Russia
Phone: 7495 937 634
E-mail: russia@amphenol.com

CHINA
Amphenol Aerospace China Office
Phone: +607-563-4060
E-mail: ChinaSales@amphenol-aao.com

INDIA
Amphenol Interconnect India, Pvt, Ltd.
105 Bhosari Industrial Area
Pune, 411 026, India
Phone: (91-20) 27120 481
Fax: (91-20) 27120 581
E-mail: sales@amphenol-in.com

JAPAN
Amphenol Japan Mil Aero & Industrial
471-1, Deba, Ritto-city
Shiga 520-3041, Japan
Phone: 81-77553-8501
Fax: 81-77551-2200

KOREA
Amphenol Aerospace Korea Office
Phone: +607-563-4061
E-mail: KoreaSales@amphenol-aao.com

SOUTHEAST ASIA
Amphenol Aerospace SouthEast Asia Office
Phone: +607-563-4062
E-mail: SouthEastAsiaSales@amphenol-aao.com

TAIWAN
Amphenol Aerospace Taiwan Office
Phone: +607-563-4063
E-mail: TaiwanSales@amphenol-aao.com

Notice: Specifications are subject to change without notice. Contact your nearest Amphenol Corporation Sales Office for the latest specifications. All statements, information and data given herein are believed to be accurate and reliable but are presented without guarantee, warranty, or responsibility of any kind expressed or implied. Statements or suggestions concerning possible use of our products are made without representation or warranty that any such use is free of patent infringement and are not recommendations to infringe any patent. The user should not assume that all safety measures are indicated or that other measures may not be required. Specifications are typical and may not apply to all connectors.

Mouser Electronics

Authorized Distributor

Click to View Pricing, Inventory, Delivery & Lifecycle Information:

Amphenol:

[ACA3106E16S1PB](#) [ACA3106E-18-11SB\(F80\)](#) [ACA3100G2027PB](#) [ACA3101R14S5PBF80](#) [ACA3101R14S7PBF80](#)
[ACA3102E1811PB](#) [ACA3106E14S5SB](#) [ACA3106E-14S-7SB](#) [ACA3102E-18-10SB-A23](#) [ACA3102E207SB](#)
[ACA3106E18-11SB](#) [ACA3106E20-27PB](#) [ACA3102E207PB](#) [ACA 3106E 20-7P B](#) [ACA3102E14S7SB](#) [ACA3102E14S-](#)
[5SB](#) [ACA3106E14S-5PB](#) [ACA3106E20-27SB](#) [ACA3102E20-27SB](#) [ACA3106E-24-11PB](#) [ACA3102E36-3SB-](#)
[F80\(A232\)](#) [ACA3102E-22-2SB-A23](#) [ACA3106E16-11P-B](#) [ACA3102E16S-1PB](#) [ACA3106E-14S-1PB-F80](#)
[ACA3102E20-27PB](#) [ACA3102E-20-14PB-F80](#) [ACA3100E-14S-1SB-F80T00](#) [ACA3106E2029SBF80](#) [ACA3106E-22-](#)
[2SB-F85A23](#) [ACA3106G1610PB](#) [ACA3102E16S-1SB](#) [ACA3106E-24-11SB](#) [ACA3101E-16-11PB-F80](#)
[ACA3100F10SL3SB](#) [ACA3102E-24-11PB](#) [ACA3100E-10SL-4SB](#) [ACA3106E-20-15PWB-F80](#) [ACA3106E-22-2SB-A23](#)
[ACA3102E10SL-3SB](#) [ACA3108E-10SL-3PB](#) [ACA3102E32-1PB-F80\(A232\)](#) [ACA3106E16S-1SB](#) [ACA3102E-22-2PB-](#)
[A23](#) [ACA3102E24-11SB](#) [ACA3102E20-15SBF80](#) [ACA3100F16S-1PB](#) [ACA3106E28-21SB](#) [ACA3106F20-19PB](#)
[ACA3106F20-14SB](#) [ACA3106E14S-6PB](#) [ACA3106E22-2SB](#) [ACA3106E14S-7SBF80](#) [ACA3102E22-5SB](#)
[ACA3108E14S-7SB](#) [ACA3101R20-29PBF80](#) [ACA3106E-14S-5PB\(F80\)\(A232\)](#) [ACA3102E28-11SBF80A232](#)
[ACA3106E28-21PBA232](#) [ACA3102E18-19SBA176](#) [ACA3106R28-21PBF80](#) [ACA3106F16-11SBF80](#) [ACA3108F14S-](#)
[A7SBF80A176A232](#) [ACA3102E28-11PBF80A232](#) [ACA3102E18-1PBF80A232](#) [ACA3101E18-1SBA232](#) [ACA3106E28-](#)
[21PBF80A232](#) [ACA3100E18-11PBF80](#) [ACA3101E28-21PBF80](#) [ACA3106F22-2PWB](#) [ACA3106E20-14SBF80F42](#)
[ACA3100E36-15PBF80A232A176](#) [ACA3106E20-15PBF80](#) [ACA3106E28-21SBF80A232](#) [ACA3106E20-29SBF80A232](#)
[ACA3100F32-17SB](#) [ACA3106E18-13SA232](#) [ACA3106E20-19SBF80-RDS](#) [ACA3102E20-29SWB](#) [ACA3106F20-](#)
[29PBZA232F127](#) [ACA3106E20-29SWB](#) [ACA3106E20-4PB](#) [ACA3100F22-2SB](#) [ACA3106E20-15PBWF80](#)
[ACA3106G22-22SB](#) [ACA3106E18-19PBA232](#) [ACA3100R28-21SBT00F80F0A232](#) [ACA3106E28-84SB](#)
[ACA3106FC18-16SBF80A232](#) [ACA3100F22-2PB](#) [ACA3108E28-15PBF80A232](#) [ACA3103G18-13SB](#) [ACA3106E20-](#)
[26SB](#) [ACA3108F28-15PBF80A232](#) [ACA3106E20-26PB](#) [ACA3103E20-29SWB](#) [ACA3100F28-21PWB](#) [ACA3106E18-](#)
[1SBW](#) [ACA3106F36-15SBF80A176A232](#) [ACA3106F22-22PXB](#)