

Terminal Blocks - Single Row

Series A3000, LP3000 & CB3000 Single Row Terminal Blocks

SPECIFICATIONS

Rating: A3: 30A, 600V* #12-22 AWG
 LP3: 30A, 150V #12-22 AWG
 CB3: 30A, 600V #12-22 AWG

Wire Range: #12-22 AWG CU

Center Spacing: 0.437" or 7/16" (11.10mm)

Screw Size: #6-32 zinc-plated phillips screws.

Torque Rating: 9 lb-in.

Base: Standoffs standard for easy flux washing.

Distance Between Barriers: 0.32" (8.1mm)

Recommended PCB Hole Diameter: 0.076" (1.93mm)

Operating Temperature: 105°C (221°F) max., -40°C

(-40°F) min.

Molded Material: Black, UL Rated 94V0 Thermoplastic

Breakdown Voltage: 3500V (A3 & LP3); 8200V (CB3)

Agency Information: UL File E62622, CSA 47235;

IEC Compliance, CE Certified

*30A Rating achieved with a #10 copper wire crimped to a ring terminal;
 20 Rating without ring terminal.



Dimensions - in (mm)

A3000 & LP3000 Series

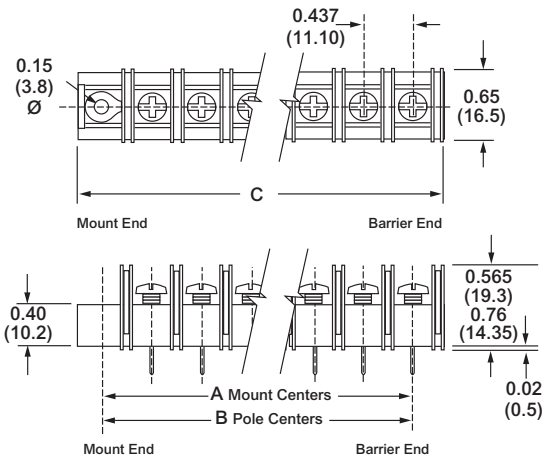

CB3000 Series

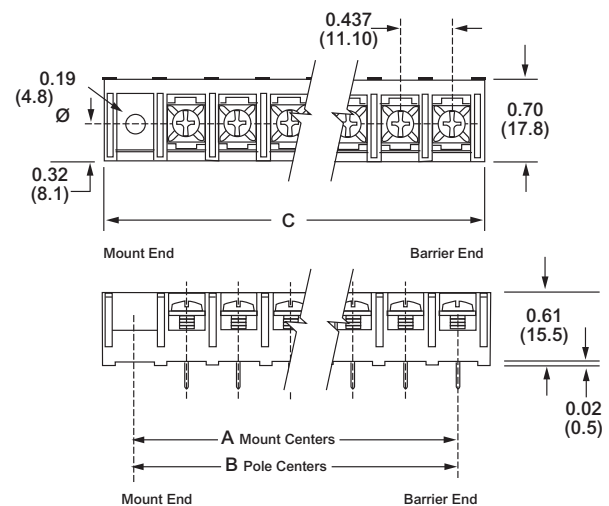

Poles	MOUNTING ENDS ONLY		BARRIER & MOUNTING ENDS B Pole Ctrs.	BARRIER ENDS ONLY C Length
	A Mount Ctrs.	C Length		
02	1.31	1.73	0.43	0.98
03	1.75	2.17	0.87	1.43
04	2.18	2.61	1.31	1.87
05	2.62	3.05	1.75	2.31
06	3.06	3.48	2.18	2.75
07	3.50	3.92	2.62	3.18
08	3.93	4.36	3.06	3.62
09	4.37	4.80	3.50	4.06
10	4.81	5.23	3.93	4.50
11	5.25	5.67	4.37	4.93
12	5.68	6.11	4.81	5.37
13	6.12	6.55	5.25	5.81
14	6.56	6.98	5.68	6.25
15	7.00	7.42	6.12	6.68
16	7.43	7.86	6.56	7.12
17	7.87	8.30	7.00	7.56
18	8.31	8.73	7.43	8.00
19	8.75	9.17	7.87	8.43
20	9.18	9.60	8.31	8.87
21	9.62	10.05	8.50	9.31
22	10.06	10.48	9.18	9.75
23	10.50	10.92	9.62	10.18
24	10.93	11.36	10.06	10.62
25	11.37	11.80	10.50	11.06
26	11.81	12.23	10.93	11.50
27	-	-	11.37	11.93
28	-	-	11.81	12.37

Dimensions in inches. To convert to millimeters, multiply by 25.4.

Series A3000 & LP3000 Single Row Terminal Blocks

Part Numbering System

Series	Terminal Style	Base/End (Views pg. 15)	Poles	Screw Options	Options
A3 LP3					
A3 - standard barrier LP3 - low profile barrier	01 - handwired 02 - printed circuit 03 - non feed-thru 04 - wire wrap tail 05 - extended handwired 06 - handwired 07 - extended pin 08 - printed circuit 09 - 0.250 QC short 10 - 0.187 QC 14 - printed circuit 19 - 0.250 QC long	1 - flat base/mnt. end 2 - flat base/barrier end 3 - insulator base/mnt. end 4 - insulator base/barrier end *5 - closed base/mount end	02 to 28 02 to 26 on mount end base	Blank - std. screw 00 - screws shipped bulk 03 - stainless steel 04 - brass nickel-plated 07 - steel SEMS zinc-plated (not available with hardware options) 09 - brass SEMS nickel-plated (not available with hardware options) 07WR - steel SEMS wire ready (A3 only) CA - captive screw	AB - angle mnt. options (pg 15) A1 to A9 - 0.250" QC B1 to B9 - 0.187" QC DR - drilled right angle (pg 15) †J201 - flat slip-on jumper L1 to L6 marking options (pg 22) MP, MP8 & MT mounting plates (pg 15) †OJ3, OJ5 & OJ7 - over barrier jumpers RC - retaining clips (pg 15) R30 to R77 - right angle bends (pg 15) SO - stand off insulators (pg 15) S1 - solder lug/flat
		*Base/End Note: 5 Style only available with 03 terminals.			

ready (A3 only)

†Contact factory for configuration.

Terminal Styles

Inches (Millimeters)

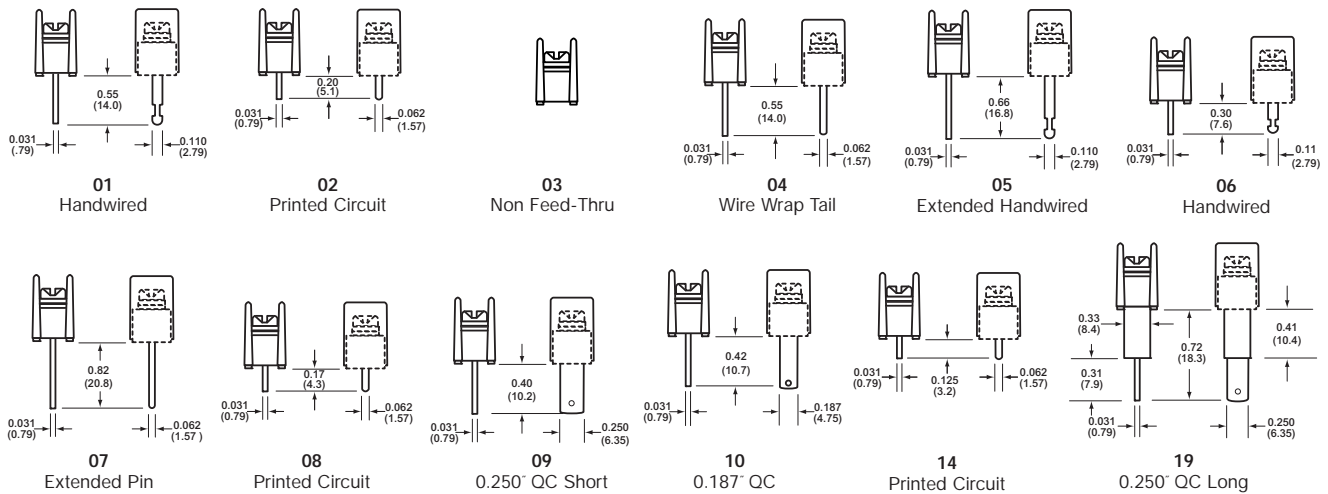

Screw Options

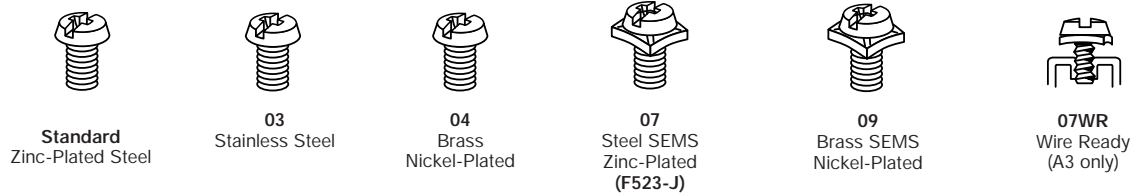

Terminal Blocks - Single Row

Series A3000 & LP3000 Single Row Terminal Blocks *Continued*

Hardware Options (Bulk ordering part numbers are in parentheses.)

Inches (Millimeters)

Solder Lugs

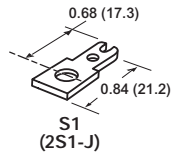

Jumpers

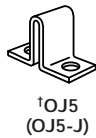
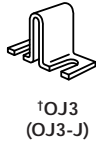

Quick Connects

Blade Width A = 0.250" Blade Width B = 0.187"

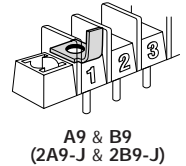
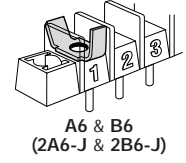
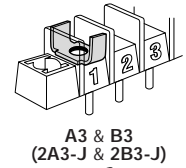
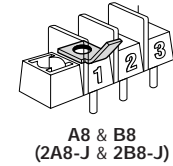
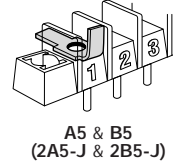
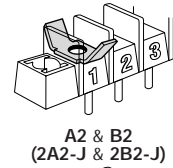
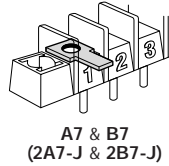
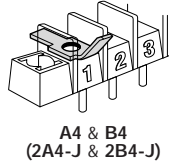
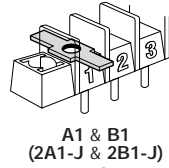

†Contact factory for pole configuration.

Base/End Options

Inches (Millimeters)

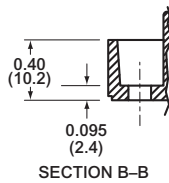
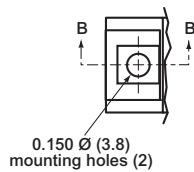

1, 3 & 5 Mount End

Series A3000 & LP3000 Single Row Terminal Blocks *Continued*

Mounting Options

Inches (Millimeters)

Right Angle Bends (A3, LP3 only)

Right angle terminals are offered on the A3000 & LP3000 Series. Configurations are defined in these dimensions: X = pin extension beyond the block base; Z = length from block base to centerline of the terminal tip. Standard bends consist of the X and Z dimensions shown in the chart. Specify by adding the selected Bend Option Code to the terminal part number.

04 Terminal Bend Configurations

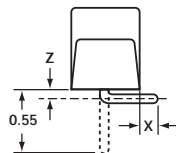

Bend Option Code	X (minimum)	Z	Available w/insulator base
R30	0.04	0.28	No
R35	0.01	0.23	No
R36	0.02	0.22	No
R39	0.05	0.19	No
R42	0.08	0.16	No
R46	0.12	0.12	No
R48	0.14	0.10	No
R50	0.16	0.08	No

07 Terminal Bend Configurations

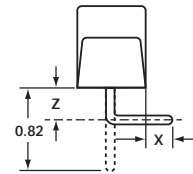

Bend Option Code	X (minimum)	Z	Available w/insulator base
R30	0.04	0.55	Yes
R35	0.01	0.50	Yes
R36	0.02	0.49	Yes
R50	0.16	0.35	No
R53	0.19	0.32	No
R66	0.32	0.19	No
R69	0.35	0.16	No
R75	0.41	0.10	No
R77	0.43	0.08	No

Dimensions in inches. To convert to millimeters, multiply by 25.4.

Angle Brackets (A3, LP3 only)

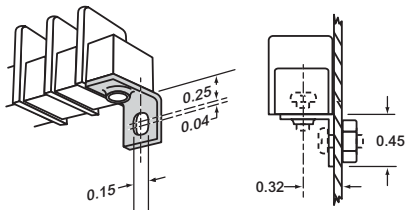

Option AB

Angle brackets enable block to be fastened at right angles to normal mount position. Bulk part number **2AB-J**.

Drilled Right Angle (A3, LP3 only)

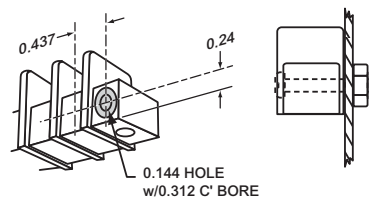

Option DR

Counterbored holes across mount ends of block enable fastening with two screws at right angles to normal mount position.

Mounting Plates

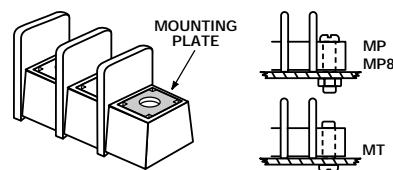

Options MP, MP8 & MT

MP Metal inserts with 0.150" dia. hole accept #6 screw. MP8 Metal inserts with 0.187" dia. hole accept #8-32 screw. MT Metal inserts with tapped hole accept #6-32 screw.

Standoffs

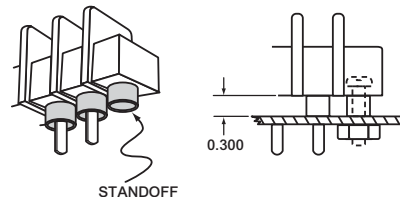

Option SO

Standoff mounts are tubes molded to the mounting positions. Available with insulator bases only.

Retaining Clip

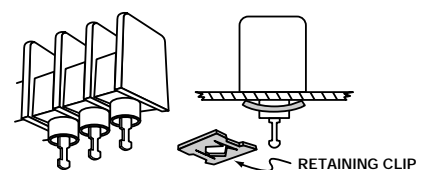

Option RC

Use on standoff tubes. Fit panels up to 0.125" thick. Two clips for every five positions. Supplied unassembled. Bulk part number **H541-J**.

Terminal Blocks - Single Row

Series CB3000

Single Row Terminal Blocks

Part Numbering System

Series	Terminal Style	Base/End	Poles	Screws	Options
CB3					
CB3 - closed back	01 - handwired #6-32 screw 02 - printed circuit #6-32 screw 03 - non feed-thru #6-32 screw 07 - extended pin #6-32 screw 14 - printed circuit #6-32 screw 51 - handwired #8-32* 52 - printed circuit #8-32* 53 - non feed-thru #8-32* 57 - extended pin #8-32* 64 - printed circuit #8-32* *Note: #8-32 screw is a special with #6-32 head.	1 - mount end 2 - barrier end 5 - closed base/ mount end	02 to 28 02 to 26 on mount end base	07 - steel SEMS (standard) 09 - brass SEMS nickel-plated CA - SEMS captive	AB - angle mounting brackets (pg 17) A7 to A9 - 0.250" QC B7 to B9 - 0.187" QC EB - exit back terminals L1 to L6 marking options (pg 22) LT1 to LT6 marking options (pg 22) † OJ3 & OJ7 - over barrier jumpers MP, MP8, MT & MT8 mtg. plates (pg 17) S1 - solder lug/flat Covers - (pg 23)
		Base/End Note: 5 Style only available with 03 terminals.			†Contact factory for configuration.

Terminal Styles

Inches (Millimeters)

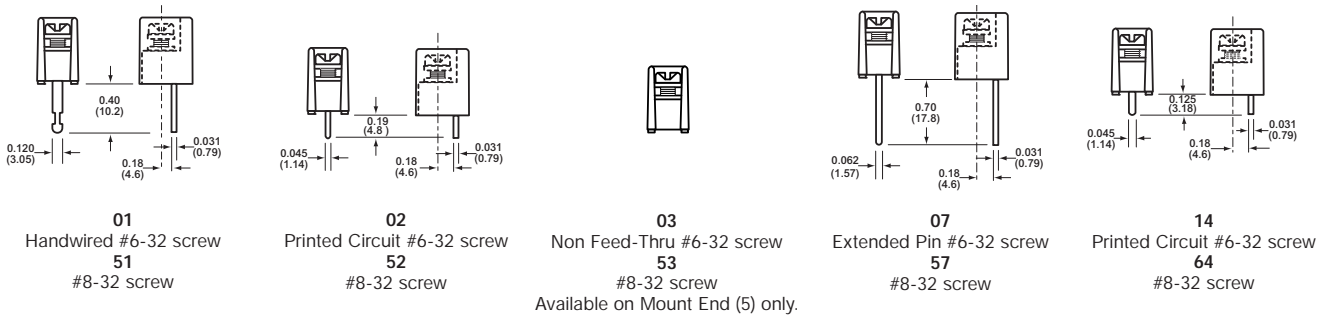

Screw Options



07
Steel SEMS
Zinc-Plated
(standard)



09
Brass SEMS
Nickel-Plated

* NOTE: Wire ready screws standard on all terminal styles.

CB3 Terminal Exit Options

Inches (Millimeters)

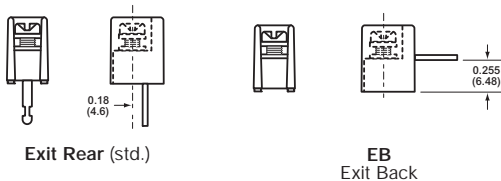

Series CB3000

Single Row Terminal Blocks *Continued*

Hardware Options (Bulk ordering part numbers are in parentheses.) Inches (Millimeters)

Solder Lugs

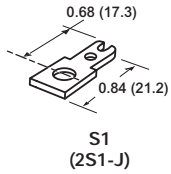

Jumpers

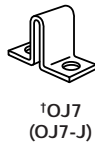
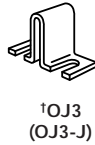

Quick Connects

Blade Width A = 0.250". Blade Width B = 0.187".

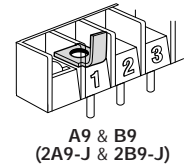
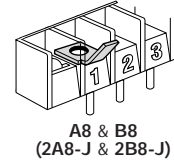
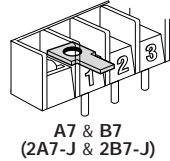

[†]Contact factory for pole configuration.

Mounting Options Inches (Millimeters)

Right Angle Mounting Bracket

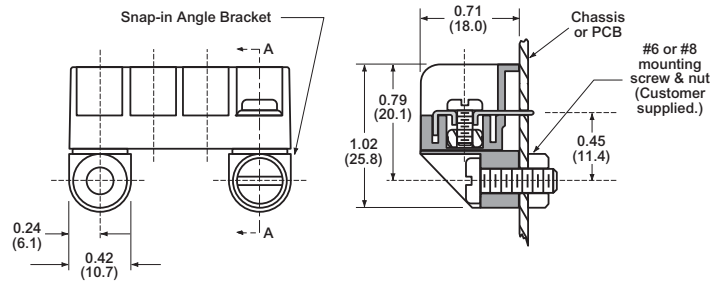
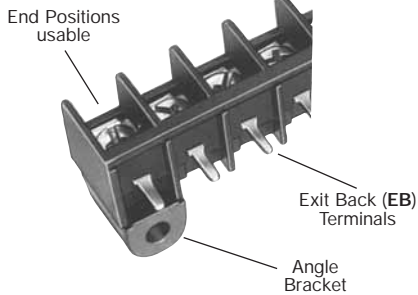

Option AB

Mounts blocks on PC boards at a right angle.

- Protects solder joints.
- Recommended for all EB (Exit Back) PCB terminal blocks.
- Bracket snaps securely on block (no hardware required).
- Minimum strip length (end positions are usable).
- Mount with #6-32 or #8-32 screws (not supplied).

Mounting Plates

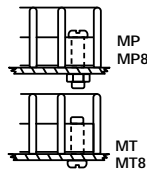
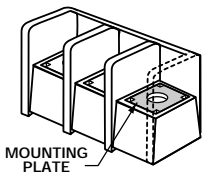

Options MP, MP8, MT & MT8

- MP** Metal inserts with 0.150" dia. hole accept #6 screw.
- MP8** Metal inserts with 0.187" dia. hole accept #8-32 screw.
- MT** Metal inserts with tapped hole accept #6-32 screw.
- MT8** Metal inserts with tapped hole accept #8-32 screw.

Terminal Blocks - Single Row

Series A38 / B38

Single Row Terminal Blocks

SPECIFICATIONS

Rating: A38: 30A, 600V

B38: 50A, 300V

Center Spacing: 0.437" (11.10mm)

Wire Range: A38: #10-22 AWG CU; B38: #8-16 AWG

Screw Size: #8-32 zinc-plated steel

Torque Rating: A38: 9 lb-in; B38: 15 lb-in for #8, 9 lb-in for #6

Base: A38 Only: Standoffs standard for easy flux washing

Distance Between Barriers: 0.378" (9.60mm)

Recommended PCB Hole Diameter (A38): 0.076" (1.93mm)

Operating Temperature: 221°F (105°C)

Molded Material: Black, UL Rated 94V0 Thermoplastic

Breakdown Voltage: 5000V

Agency Information: UL File E62622, CSA File 47235;

CE Certified



A382208



B384904

TABLE A

Poles	MOUNTING ENDS ONLY		BARRIER ENDS ONLY	
	B Mount Ctrs.	"A" Dim. Length	"A" Dim. Length	
02	1.31	1.67	0.93	
03	1.75	2.10	1.37	
04	2.19	2.54	1.81	
05	2.62	2.98	2.25	
06	3.06	3.41	2.68	
07	3.50	3.85	3.12	
08	3.93	4.29	3.56	
09	4.37	4.72	3.99	
10	4.81	5.16	4.43	
11	5.24	5.60	4.87	
12	5.68	6.04	5.30	
13	6.12	6.47	5.74	
14	6.56	6.91	6.18	
15	6.99	7.35	6.61	
16	7.43	7.78	7.05	

* Dimensions in inches. To convert to millimeters, multiply by 25.4.

Dimensions - in (mm)

Series A38

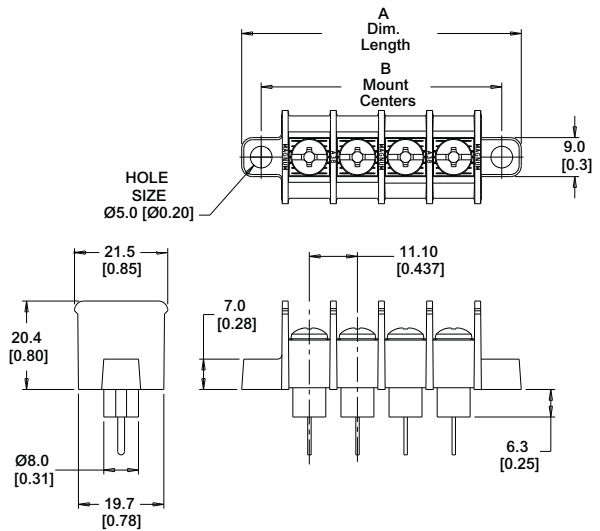

Series B38

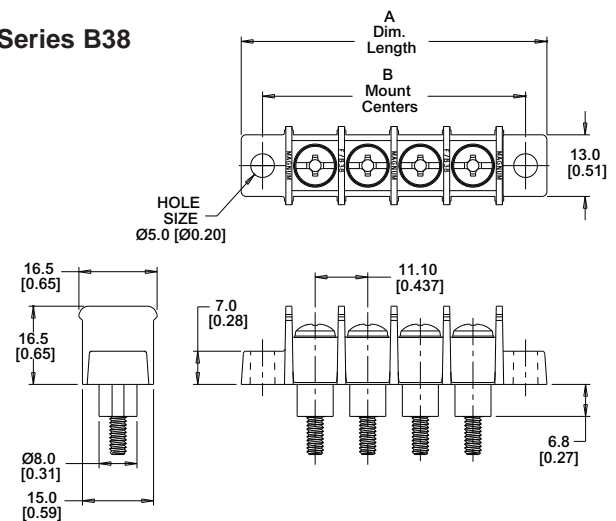

Part Numbering System

Series	Terminal Style	Base/End	# of Poles	Screw Options	Options
A3B					
	0 - 0.187" QC 1 - hand wired 2 - printed circuit 7 - extended wire wrap 9 - 0.250" QC	1 - flat base, mount end 2 - flat base, barrier end 3 - insulator base* mount end 4 - insulator base* barrier end *N/A on 2 terminal style.	02 to 16	Blank - standard screw (steel zinc-plated, philslot BHMS) 04 - brass, nickel-plated, philslot BHMS 07 - steel, SEMS zinc-plated philslot screw 92 - steel, zinc-plated slotted BHMS 94 - brass, nickel-plated slotted BHMS (Binding Hard Machine Screw)	L1 to L6 marking options (pg 22) RC - retaining clips (pg 15) Covers - (pg 23)
B3B					
	1 - long turret 2 - short turret 3 - screw terminal #6-32 screw top & bottom 4 - stud (#8-32 screw top, #6-32 stud bottom) 15 - double stud (#6-32 stud top & bottom) 1C360 Copper alloy (bright tin plate)	0 - flat base, mount ends 4 - insulator base, barrier ends 9 - insulator base mount ends	02 to 16	Blank - standard screw steel zinc-plated philslot BHMS 04 - brass, nickel-plated, philslot BHMS #8-32 *34 - #6-32 nickel-plated brass philslot BHMS *Note: 34 screws only *available with 3 terminal style.	L1 to L6 marking options (pg 23) RC - retaining clips (pg 16)

A38 Terminal Styles Wire ready screws standard

Inches (Millimeters)

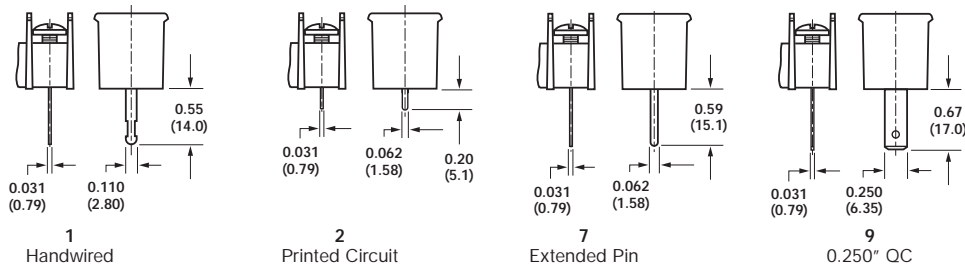

B38 Terminal Styles

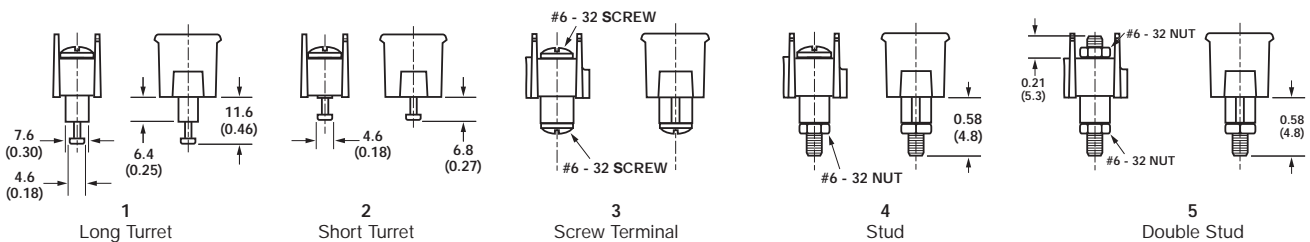

Screw Options



AMEYA360

Components Supply Platform

Authorized Distribution Brand :



Website :

Welcome to visit www.ameya360.com

Contact Us :

➤ Address :

401 Building No.5, JiuGe Business Center, Lane 2301, Yishan Rd
Minhang District, Shanghai , China

➤ Sales :

Direct +86 (21) 6401-6692

Email amall@ameya360.com

QQ 800077892

Skype [ameyasales1](#) [ameyasales2](#)

➤ Customer Service :

Email service@ameya360.com

➤ Partnership :

Tel +86 (21) 64016692-8333

Email mkt@ameya360.com