

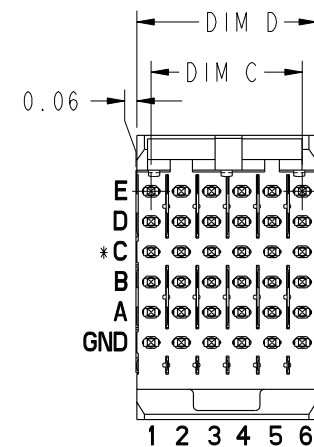

This document is the property of and embodies  
 CONFIDENTIAL and PROPRIETARY information of FCI.  
 No part of the information shown on this  
 document may be used in any way or disclosed  
 to others without the written consent of FCI.  
 Copyright FCI.

PRODUCT NUMBER	PLATING PERFORMANCE LEVEL	DIM C	DIM D	PRESS FIT TAIL PLATING	SHROUD P/N FOR REAR PLUG UP APPLICATIONS
84809-101ZZZ	TELCORDIA CO	10.00	11.88	STANDARD	84811-101
84809-101ZZZLF				LEAD-FREE	84811-101LF
84809-102ZZZ		22.00	23.88	STANDARD	84811-102
84809-102ZZZLF				LEAD-FREE	84811-102LF
84809-103ZZZ		34.00	35.88	STANDARD	84811-103
84809-103ZZZLF				LEAD-FREE	84811-103LF
84809-104ZZZ	46.00	47.88	STANDARD	84811-104	
84809-104ZZZLF			LEAD-FREE	84811-104LF	
84809-501ZZZ	TELCORDIA UE	10.00	11.88	STANDARD	84811-501
84809-501ZZZLF				LEAD-FREE	84811-501LF
84809-502ZZZ		22.00	23.88	STANDARD	84811-502
84809-502ZZZLF				LEAD-FREE	84811-502LF
84809-503ZZZ		34.00	35.88	STANDARD	84811-503
84809-503ZZZLF				LEAD-FREE	84811-503LF
84809-504ZZZ	46.00	47.88	STANDARD	84811-504	
84809-504ZZZLF			LEAD-FREE	84811-504LF	

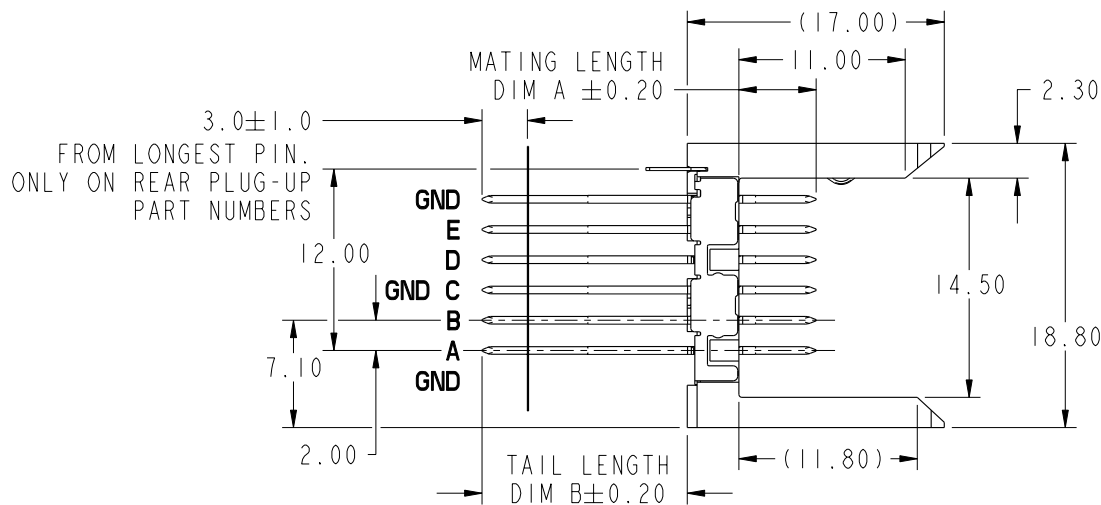
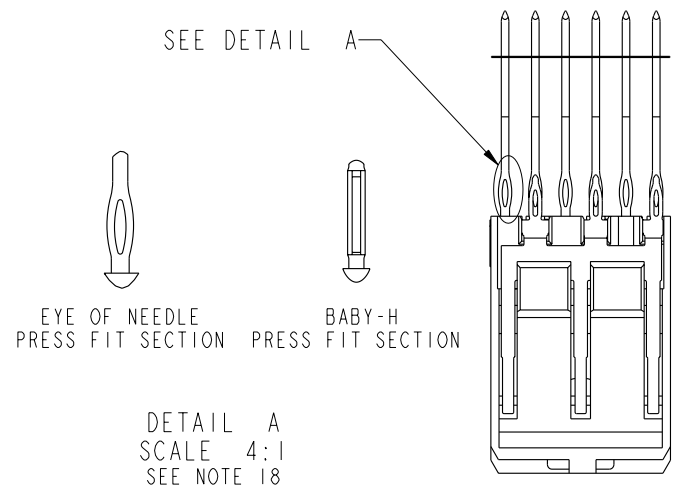

**\*ROW C INFORMATION**  
 ODD NUMBER COLUMNS WITHIN ROW C ARE COMMONED TO GROUND INTERNALLY WITHIN THE HOUSING. THE EVEN NUMBER COLUMNS WITHIN ROW C ARE NOT. FOR MAXIMUM PERFORMANCE IT IS RECOMMENDED THESE EVEN COLUMNS BE GROUND COMMONED WITHIN PCB.  
 SEE NOTE 15

mat'l code SEE NOTE 5				tolerances unless otherwise specified			CUSTOMER	FCI www.fciconnect.com	
ltr	ecn no.	dr	date	linear	0.X ± 0.3	COPY	title VERTICAL SIGNAL HDR. 5 ROW P.F. SPECIAL LOAD EXT. product family METRAL 2000 code 213 size dwg no 84809 sheet 1 of 6		
P	V06-0569	DCH	2006-06-12	linear	0.XX ± 0.13	projection			
R	V07-0501	DCH	2007-07-31	angles	.XXX ± .051	MM			
S	V08-0057	HTB	2008-02-04	angles	0° ± 2°	scale 1:1			
T	V08-0065	LP	2008-03-19	dr	E. KROPER. 2001-06-20	size A cage code 22526			
-	-	-	-	enrg	J. VOLSTORF 2001-06-20				
M	V03-1156	TAB	2003-11-03	chr	J. VOLSTORF 2001-06-20				
N	V05-0814	VS	2005-09-21	appd	J. VOLSTORF 2001-06-20				
sheet index	revision sheet	T	T	T	T	T	T	T	T
		1	2	3	4	5	6		

PIN NO.	DIM A MATING LENGTH	DIM B TAIL LENGTH	PCB THICKNESS RANGE ACCOMMODATED BY PIN'S TAIL LENGTH				
			WHEN MATING TO A 73981 OR 84688 SERIES RECEPTACLE		WHEN MATING TO A 52057 SERIES METRAL 4000 RECEPTACLE		
			ROWS: A, B, C, D, AND E	GROUND ROW	ROWS: A, B, D, AND E	ROW C	GROUND ROW
01*	5.00	4.30	1.60 MIN	1.60 MIN	1.60 MIN	1.60 MIN	1.60 MIN
22		12.20	2.95 - 3.80	2.95 - 4.20	2.95 - 3.80	2.95 - 3.80	2.95 - 4.20
30		12.95	2.95 - 4.55	3.25 - 4.95	2.95 - 4.55	2.95 - 4.55	3.25 - 4.95
05		13.70	2.95 - 5.30	4.00 - 5.70	3.30 - 5.30	2.95 - 5.30	4.00 - 5.70
35		14.45	3.05 - 6.05	4.75 - 6.45	4.05 - 6.05	3.05 - 6.05	4.75 - 6.45
48		15.20	3.80 - 6.80	5.50 - 7.20	4.80 - 6.80	3.80 - 6.80	5.50 - 7.20
40		15.70	4.30 - 7.30	6.00 - 7.70	5.30 - 7.30	4.30 - 7.30	6.00 - 7.70
65		16.40	5.00 - 8.00	6.70 - 8.40	6.00 - 8.00	5.00 - 8.00	6.70 - 8.40
09		17.10	5.70 - 8.70	7.40 - 9.10	6.70 - 8.70	5.70 - 8.70	7.40 - 9.10
02*	5.75	4.30	1.60 MIN	1.60 MIN	1.60 MIN	1.60 MIN	1.60 MIN
44		12.20	2.95 - 3.80	2.95 - 4.20	2.95 - 3.80	2.95 - 3.80	2.95 - 4.20
31		12.95	2.95 - 4.55	3.25 - 4.95	2.95 - 4.55	2.95 - 4.55	3.25 - 4.95
06		13.70	2.95 - 5.30	4.00 - 5.70	3.30 - 5.30	2.95 - 5.30	4.00 - 5.70
36		14.45	3.05 - 6.05	4.75 - 6.45	4.05 - 6.05	3.05 - 6.05	4.75 - 6.45
49		15.20	3.80 - 6.80	5.50 - 7.20	4.80 - 6.80	3.80 - 6.80	5.50 - 7.20
25		15.70	4.30 - 7.30	6.00 - 7.70	5.30 - 7.30	4.30 - 7.30	6.00 - 7.70
66		16.40	5.00 - 8.00	6.70 - 8.40	6.00 - 8.00	5.00 - 8.00	6.70 - 8.40
10		17.10	5.70 - 8.70	7.40 - 9.10	6.70 - 8.70	5.70 - 8.70	7.40 - 9.10
03*	6.50	4.30	1.60 MIN	1.60 MIN	1.60 MIN	1.60 MIN	1.60 MIN
45		12.20	2.95 - 3.80	2.95 - 4.20	2.95 - 3.80	2.95 - 3.80	2.95 - 4.20
32		12.95	2.95 - 4.55	3.25 - 4.95	2.95 - 4.55	2.95 - 4.55	3.25 - 4.95
07		13.70	2.95 - 5.30	4.00 - 5.70	3.30 - 5.30	2.95 - 5.30	4.00 - 5.70
37		14.45	3.05 - 6.05	4.75 - 6.45	4.05 - 6.05	3.05 - 6.05	4.75 - 6.45
50		15.20	3.80 - 6.80	5.50 - 7.20	4.80 - 6.80	3.80 - 6.80	5.50 - 7.20
41		15.70	4.30 - 7.30	6.00 - 7.70	5.30 - 7.30	4.30 - 7.30	6.00 - 7.70
24		16.40	5.00 - 8.00	6.70 - 8.40	6.00 - 8.00	5.00 - 8.00	6.70 - 8.40
11		17.10	5.70 - 8.70	7.40 - 9.10	6.70 - 8.70	5.70 - 8.70	7.40 - 9.10



This document is the property of and embodies CONFIDENTIAL and PROPRIETARY information of FCI. No part of the information shown on this document may be used in any way or disclosed to others without the written consent of FCI. Copyright FCI.

\* STUB PINS - NO REAR PLUG-UP

\*\* THE GREATEST RANGE OCCURS WHEN THE B DIMENSION OF PIN 'GND' IS ONE SIZE SHORTER THEN THE OTHER PINS.

mat'l code SEE NOTE 5				tolerances unless otherwise specified		CUSTOMER	FCI www.fciconnect.com		
ltr	ecn no.	dr	date	linear	0.X ±0.3	projection	COPY		
T					0.XX ±0.13		title		
					.XXX ±.051		VERTICAL SIGNAL HDR. 5 ROW P.F. SPECIAL LOAD EXT.		
				angles	0° ±2°	 MM	product family	METRAL 2000	code
				dr	E. KROPER. 2001-06-20		size	dwg no	213
				engr	J. VOLSTORF 2001-06-20		A	84809	sheet
				chr	J. VOLSTORF 2001-06-20				2
				appd	J. VOLSTORF 2001-06-20	scale	1:1		
sheet index	revision sheet						cage code	22526	

PIN NO.	DIM A MATING LENGTH	DIM B TAIL LENGTH	PCB THICKNESS RANGE ACCOMMODATED BY PIN LENGTH				
			WHEN MATING TO A 73981 OR 84688 SERIES RECEPTACLE		WHEN MATING TO A 52057 SERIES METRAL 4000 RECEPTACLE		
			ROWS: A, B, C, D, AND E	GROUND ROW	ROWS: A, B, D, AND E	ROW C	GROUND ROW
04*	7.25	4.30	1.60 MIN	1.60 MIN	1.60 MIN	1.60 MIN	1.60 MIN
46		12.20	2.95 - 3.80	2.95 - 4.20	2.95 - 3.80	2.95 - 3.80	2.95 - 4.20
33		12.95	2.95 - 4.55	3.25 - 4.95	2.95 - 4.55	2.95 - 4.55	3.25 - 4.95
08		13.70	2.95 - 5.30	4.00 - 5.70	3.30 - 5.30	2.95 - 5.30	4.00 - 5.70
38		14.45	3.05 - 6.05	4.75 - 6.45	4.05 - 6.05	3.05 - 6.05	4.75 - 6.45
51		15.20	3.80 - 6.80	5.50 - 7.20	4.80 - 6.80	3.80 - 6.80	5.50 - 7.20
42		15.70	4.30 - 7.30	6.00 - 7.70	5.30 - 7.30	4.30 - 7.30	6.00 - 7.70
67		16.40	5.00 - 8.00	6.70 - 8.40	6.00 - 8.00	5.00 - 8.00	6.70 - 8.40
12		17.10	5.70 - 8.70	7.40 - 9.10	6.70 - 8.70	5.70 - 8.70	7.40 - 9.10
19*	8.00	4.30	1.60 MIN	1.60 MIN	1.60 MIN	1.60 MIN	1.60 MIN
47		12.20	2.95 - 3.80	2.95 - 4.20	2.95 - 3.80	2.95 - 3.80	2.95 - 4.20
34		12.95	2.95 - 4.55	3.25 - 4.95	2.95 - 4.55	2.95 - 4.55	3.25 - 4.95
20		13.70	2.95 - 5.30	4.00 - 5.70	3.30 - 5.30	2.95 - 5.30	4.00 - 5.70
39		14.45	3.05 - 6.05	4.75 - 6.45	4.05 - 6.05	3.05 - 6.05	4.75 - 6.45
52		15.20	3.80 - 6.80	5.50 - 7.20	4.80 - 6.80	3.80 - 6.80	5.50 - 7.20
43		15.70	4.30 - 7.30	6.00 - 7.70	5.30 - 7.30	4.30 - 7.30	6.00 - 7.70
68		16.40	5.00 - 8.00	6.70 - 8.40	6.00 - 8.00	5.00 - 8.00	6.70 - 8.40
21		17.10	5.70 - 8.70	7.40 - 9.10	6.70 - 8.70	5.70 - 8.70	7.40 - 9.10

A

A



This document is the property of and embodies CONFIDENTIAL and PROPRIETARY information of FCI. No part of the information shown on this document may be used in any way or disclosed to others without the written consent of FCI. Copyright FCI.

B

\* STUB PINS - NO REAR PLUG-UP

\*\* THE GREATEST RANGE OCCURS WHEN THE B DIMENSION OF PIN 'GND' IS ONE SIZE SHORTER THEN THE OTHER PINS.

mat'l code SEE NOTE 5				tolerances unless otherwise specified		CUSTOMER	www.fciconnect.com		
ltr	ecn no.	dr	date	linear	0.X ±0.3	projection	COPY		
T					0.XX ±0.13				title
					.XXX ±.051				
				angles	0° ±2°		product family	METRAL 2000	code
				dr	E. KROPER. 2001-06-20		size	dwg no	213
				engr	J. VOLSTORF 2001-06-20		A	84809	sheet
				chr	J. VOLSTORF 2001-06-20				
				appd	J. VOLSTORF 2001-06-20				
sheet index	revision sheet								

B

PRODUCT NUMBER  
SEE SHEET 1

PRESS-FIT HOLES	OPTION 1
HOLE DIAMETER AFTER PLATING	Ø 0.65-0.80
DRILLED HOLE	Ø 0.81-0.86 (Ø 0.85 DRILL)
COPPER PLATING	0.025 MIN
SnPb PLATING	0.005-0.015

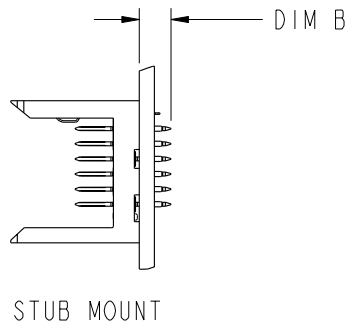

SEE PRINT 58351 FOR ADDITIONAL PCB INFORMATION.

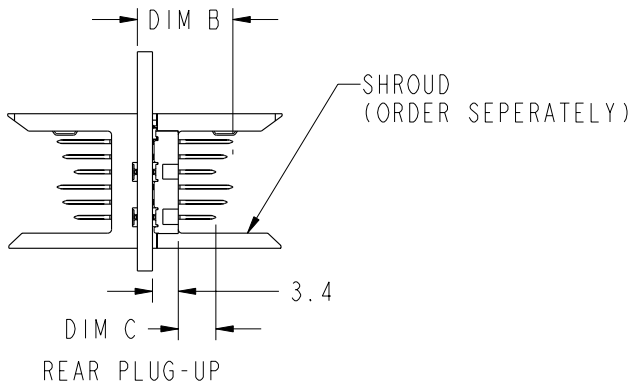
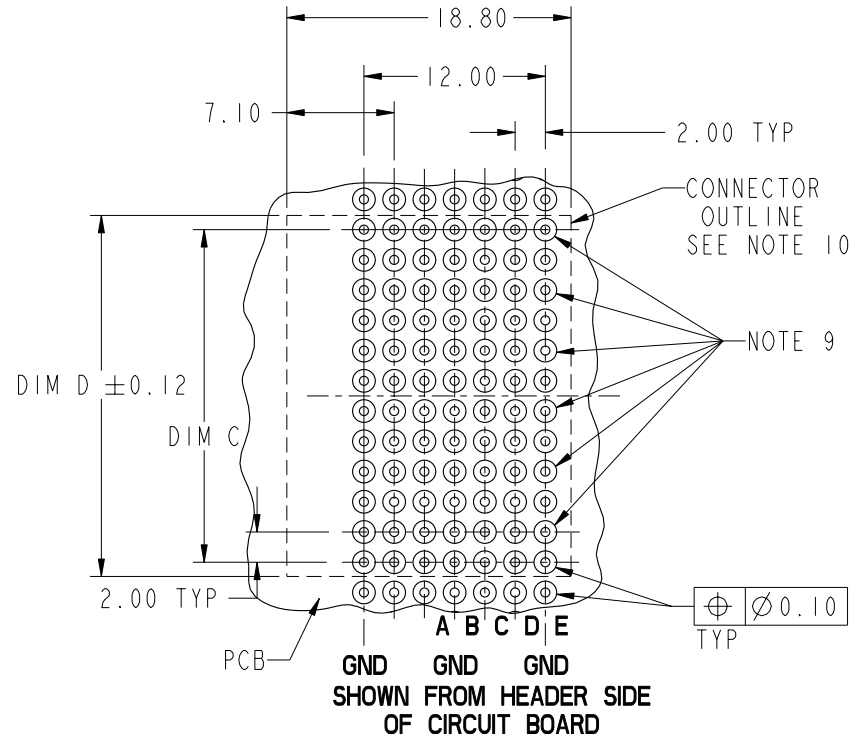

mat'l code SEE NOTE 5				tolerances unless otherwise specified		CUSTOMER	FCj www.fciconnect.com		
ltr	ecm no.	dr	date	linear	0.X ±0.3	COPY	title		
T					0.XX ±0.13	projection	VERTICAL SIGNAL HDR. 5 ROW P.F. SPECIAL LOAD EXT.		
				angles	.XXX ±.051		product family		
					0° ±2°		MM	METRAL 2000	code
				dr	E. KROPER. 2001-06-20		size	dwg no	213
				engr	J. VOLSTORF 2001-06-20		A	84809	sheet
				chr	J. VOLSTORF 2001-06-20		1:1		4
				appd	J. VOLSTORF 2001-06-20				
sheet index	revision sheet								

This document is the property of and embodies CONFIDENTIAL and PROPRIETARY information of FCj. No part of the information shown on this document may be used in any way or disclosed to others without the written consent of FCj. Copyright FCj.

PRODUCT NUMBER  
SEE SHEET 1

NOTES:

- 1. SEE APPLICATION SPECIFICATION GS-20-010 FOR INFORMATION ON AVAILABLE TOOLING, CIRCUIT BOARD DESIGN CONSIDERATIONS, REPAIR PROCEDURES AND PRODUCT OFFERINGS.
- 2. SEE FCI PUBLICATION 950511-028 FOR "ELECTRICAL PERFORMANCE DATA FOR DIFFERENTIAL APPLICATIONS."
- 3. SEE FCI PUBLICATION 950511-029 FOR "ELECTRICAL PERFORMANCE DATA FOR SINGLE-ENDED APPLICATION."
- 4. UNLESS OTHERWISE SPECIFIED, ALL DIMENSIONS AND TOLERANCES ARE IN ACCORDANCE WITH ASME Y14.5M, 1994
- 5. HOUSING MATERIAL: LIQUID CRYSTAL POLYMER, 30% GLASS FILLED, FLAME RETARDANT PER UL 94-V0.  
PIN MATERIAL: PHOSPHOR BRONZE  
GROUND SPRING MATERIAL: PHOSPHOR BRONZE  
STRIPLINE SHIELD MATERIAL: PHOSPHOR BRONZE
- 6. PLATING INFORMATION: PLATING ON CONTACT AREA MEETS THE PERFORMANCE LEVELS SHOWN IN TABLE ON SHEET 1. PLATING ON "LF" TAILS IS Sn. PLATING ON ALL OTHER TAILS IS SnPb.

- 11. CURRENT RATING : 1 AMP PER PIN
- 12. TEMPERATURE RANGE : -55°C TO +105°C
- 13. P/N 84809-XYZZZLF

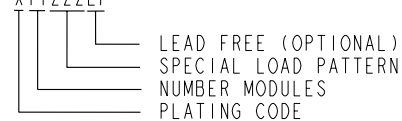

- 14. P/N 84809-XYZZZ SHOWN.
- 15. FOR FRONT PLUG-UP APPLICATIONS, THE EVEN NUMBERED PINS IN ROW 'C' CAN BE USED FOR POWER AS WELL AS FOR GROUND. IF THE SURROUNDING PINS ARE NOT USED FOR POWER, THEN EACH PIN CAN CARRY 3 AMPS. IF THE SURROUNDING PINS ARE USED FOR POWER, THEN EACH PIN CAN CARRY 1 AMP. WHEN THE SURROUNDING PINS ARE USED ONLY FOR LOW SPEED SIGNALS, THEN THE EVEN NUMBERED 'C' ROW PINS CAN ALSO BE USED FOR LOW SPEED SIGNALS. THIS IS NOT TRUE FOR REAR PLUG-UP APPLICATIONS USING METRAL 2000 SHROUD AS IN THIS CASE ALL 'C' ROW PINS ARE COMMON TO GROUND.

- 7. DIMENSIONAL RESTRICTIONS OF PINS IN HEADERS.  
FOR MATING WITH METRAL 1000 RECEPTACLES  
DIM A : 5.00mm MIN, 8.00mm MAX FOR ROWS A-E  
DIM A : 5.00mm MIN, 5.75mm MAX FOR ROW GND NEXT TO ROW A  
DIM C : 5.00mm MIN, 8.00mm MAX FOR ROWS A-E  
DIM C : 4.60mm MIN, 6.30mm MAX FOR ROW GND NEXT TO ROW A  
FOR MATING WITH METRAL 4000 RECEPTACLES  
DIM A : 5.00mm MIN, 6.50mm MAX FOR ROWS A, B, D & E  
DIM A : 5.00mm MIN, 8.00mm MAX FOR ROW C  
DIM A : 5.00mm MIN, 5.75mm MAX FOR ROW GND NEXT TO ROW A  
DIM C : 5.00mm MIN, 7.00mm MAX FOR ROWS A, B, D 0.000  
DIM C : 5.00mm MIN, 8.00mm MAX FOR ROW C  
DIM C : 4.60mm MIN, 6.30mm MAX FOR ROW GND NEXT TO ROW A

- 16. PRODUCTS WHERE THE PART NUMBERS ENDS IN LF MEET EUROPEAN UNION DIRECTIVES AND OTHER COUNTRY REGULATIONS AS DESCRIBED IN GS-22-008.

ALL PRODUCTS WILL WITHSTAND EXPOSURE TO 260°C FOR 60 SECONDS IN A CONVECTION, INFRA-RED OR VAPOR PHASE REFLOW OVEN

- 17. FOR LEAD FREE PART NUMBERS ADD 'LF' SUFFIX. EXAMPLE: 84809-XYZZLF
- 18. PIN TYPE IS AT THE MANUFACTURE'S OPTION AND CAN EITHER BABY-H OR EYE OF THE NEEDLE STYLE.

- 8. THE MIN PCB THICKNESS FOR REAR PLUG-UP APPLICATIONS IS 2.9mm SINCE THE COMPLIANT SECTIONS OF THE GROUND SPRING OF THE HEADER DIRECTLY OPPOSE THE GROUND SPRING OF THE SHROUD. THE MIN PCB THICKNESS FOR FRONT PLUG-UP ONLY APPLICATIONS IS 1.6mm.

- 9. THESE HOLES ARE NEEDED FOR REAR PLUG-UP DESIGNS USING A SHROUD AND MAY BE OMITTED FOR FRONT PLUG-UP ONLY DESIGNS.

- 10. THE 'CONNECTOR OUTLINE' IS THE MIN OUTLINE REQUIRED. TO DETERMINE THE OUTLINE NECESSARY TO PERMIT THE VARIOUS TYPES OF REPAIR OPERATIONS, SEE APPLICATION SPECIFICATION GS-20-010.

mat'l code SEE NOTE 5				tolerances unless otherwise specified		CUSTOMER		FCI www.fciconnect.com		
ltr	ecr no.	dr	date	linear	0.X ±0.3	COPY		title VERTICAL SIGNAL HDR. 5 ROW P.F. SPECIAL LOAD EXT.	product family METRAL 2000	
T					0.XX ±0.13	projection				code 213
					.XXX ±.051	MM				
				angles	0° ±2°	scale 1:1				
				dr	E. KROPER. 2001-06-20	MM		product family	code	
				enrg	J. VOLSTORF 2001-06-20	A		size	dwg no	
				chr	J. VOLSTORF 2001-06-20	A		84809	213	
				appd	J. VOLSTORF 2001-06-20	A		5		
sheet index	revision sheet									

This document is the property of and embodies CONFIDENTIAL and PROPRIETARY information of FCI. No part of the information shown on this document may be used in any way or disclosed to others without the written consent of FCI. Copyright FCI.



# SPECIAL LOAD PATTERNS

PRODUCT #	ROW	PIN CODES
84809-XXX001 SEE NOTE 17 LEAD FREE OPTION	E	01
	D	
	C	
	B	
	A	
	GND	
84809-XXX007 *RPU SEE NOTE 17 LEAD FREE OPTION	E	40
	D	
	C	
	B	
	A	
	GND	
84809-XXX011 SEE NOTE 17 LEAD FREE OPTION	E	02
	D	
	C	
	B	
	A	
	GND	
84809-XXX050 SEE NOTE 17 LEAD FREE OPTION	E	01
	D	02
	C	01
	B	
	A	
	GND	
84809-XXX051 *RPU SEE NOTE 17 LEAD FREE OPTION	E	31
	D	
	C	
	B	
	A	
	GND	
84809-XXX052 SEE NOTE 17 LEAD FREE OPTION	E	03
	D	
	C	
	B	
	A	
	GND	

PCB THICKNESS  
RANGE FOR REAR  
PLUG UP  
APPLICATIONS:  
6.00mm - 7.30 mm

PCB THICKNESS  
RANGE FOR REAR  
PLUG UP  
APPLICATIONS:  
2.95mm - 4.20mm



This document is the property of and embodies  
 CONFIDENTIAL and PROPRIETARY information of FCI.  
 No part of the information shown on this  
 document may be used in any way or disclosed  
 to others without the written consent of FCI.  
 Copyright FCI.

mat'l code SEE NOTE 5				tolerances unless otherwise specified		CUSTOMER	www.fciconnect.com		
ltr	ecn no.	dr	date	linear	0.X ±0.3	COPY	title VERTICAL SIGNAL HDR. 5 ROW P.F. SPECIAL LOAD EXT.		
T					0.XX ±0.13	projection			
					.XXX ±.051				
				angles	0° ±2°		product family METRAL 2000 code		
				dr	E. KROPER. 2001-06-20	MM	size	dwg no	
				enrg	J. VOLSTORF 2001-06-20	← MM →	A	84809	
				chr	J. VOLSTORF 2001-06-20	scale			213
				appd	J. VOLSTORF 2001-06-20	1:1			sheet
sheet index	revision sheet							6	

\*REAR PLUG-UP PART NUMBER

# Mouser Electronics

Authorized Distributor

Click to View Pricing, Inventory, Delivery & Lifecycle Information:

FCI:

[84809-104001LF](#)