

FEATURES:

- .125" (3.175mm) Contact Spacing x .250" (6.35mm) Row Spacing
- Accepts .062" (1.57mm) Nominal Thickness P.C. Board
- High Profile Insulator Body, .600" (15.24mm)
- Contact Termination Options include P.C. Tail, Wire Wrap, Wire Hole, 90 Degree Bends and Extender Board Bends
- Single or Dual Row Configurations
- Large Variety of Mounting Options, Flush or Offset Lugs
- Accepts between Contact and In-Contact Polarizing Keys
- Pre-assembled Card Guides are available
- Automatic Wire Wrap Positioning Holes
- RoHS Compliant & UL Certified

Specifications:

Insulator Material	(846: Diallyl Phthalate 896: Polyphenylene sulfide) , UL 94V-0
Contact Material	Copper Alloy
Contact Plating	Gold Plating on mating area and Tin Plating on tails with Nickel underplating all over
Current Rating	3 Amperes
Contact Resistance	10 milliohms maximum
Dielectric Withstand Voltage	1500 V AC rms at sea level between adjacent contacts
Insulation Resistance	5000 Megaohms minimum
Operating Temperature	-40°C to +125°C
Insertion Force	16oz (4.45N) maximum per contact pair when tested with .070" (1.78mm) thick gauge
Withdrawal Force	1oz (0.28N) minimum per contact pair when tested with .054" (1.37mm) thick gauge

Example Part Number: **846-056-540-802**

Series _____

Total Number of Contacts _____

Contact Code _____

Contact Rows and Insulator Style _____

Mounting Options _____

Contact Code	Description & Tail Size	Tail Length "G"
500	Wire Hole .050 x .025 (1.27 x 0.64)	.260 (6.60)
520	P.C. Tail .025 Square (0.64 Square)	.175 (4.45)
521	P.C. Tail .025 Square (0.64 Square)	.150 (3.81)
522	P.C. Tail .025 Square (0.64 Square)	.440 (11.18)
526	P.C. Tail .025 Square (0.64 Square)	.350 (8.89)
540	Wire Wrap .025 Square (0.64 Square)	.560 (14.22)
541	Wire Wrap .025 Square (0.64 Square)	.750 (19.05)
555	EXTENDER BOARD BEND (Code 500 Contacts)	
556	EXTENDER BOARD BEND (Code 520 Contacts)	
558	90 DEGREE BEND (Code 541 Contacts)	
559	90 DEGREE BEND (Code 541 Contacts)	
560	EXTENDER BOARD BEND (Code 526 Contacts)	

Series:	Insulator Color
846	Thermoset Polyester, Green
896	Thermoplastic Polyester, Black

Total Number of Contacts:	Contact Rows
005, 006, 050	Single Row
010, 012, 100	Dual Row

Contact Rows and Insulator Style	Description
1	Single Row, Flush Mounting Lugs
2	Dual Row, Flush Mounting Lugs
6	Single Row, .170 (4.32) Offset Lugs
8	Dual Row, .170 (4.32) Offset Lugs

Mounting Options:	Description
01	No Mounting Lug
02	Ø.128" (Ø3.25mm) Mounting Holes
03	Ø.116" (Ø2.95mm) I.D. Floating Eyelets
04	Ø.156" (Ø3.96mm) Mounting Holes
07	M3-0.5 Metric Threaded Inserts
08	#4-40 Unified Threaded Inserts
12	Ø.128" (Ø3.25mm) Side Mounting Holes
58	.468" (11.89mm) Offset Card Guides
78	In-Line Card Guides 2.750" (69.85mm) Long
88	In-Line Card Guides 1.250" (31.75mm) Long

Ordering Code Notes:

- 1) All connector sizes up to 50 contacts single row / 100 contacts dual row are available upon request.
- 2) For details of the extender board and 90 degree bends refer to next pages.
- 3) Consult with EDAC Inc. regarding connectors with a .420" (10.67mm) card slot depth.
- 4) For lug-less connectors, code 01 mounting, specify contact row code 1 or 2.
- 5) For details of the mounting options refer to page 3.

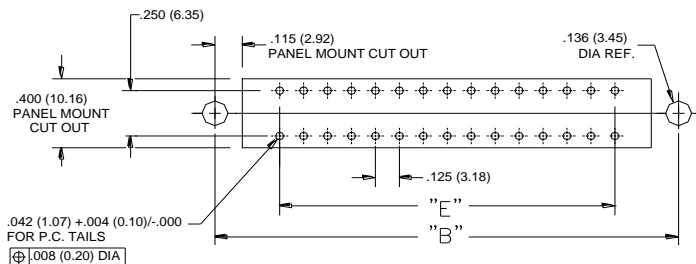
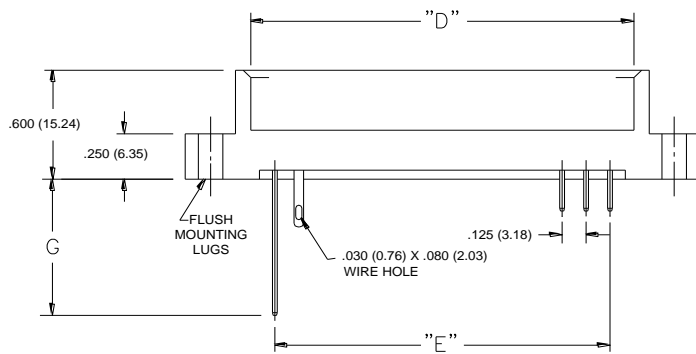
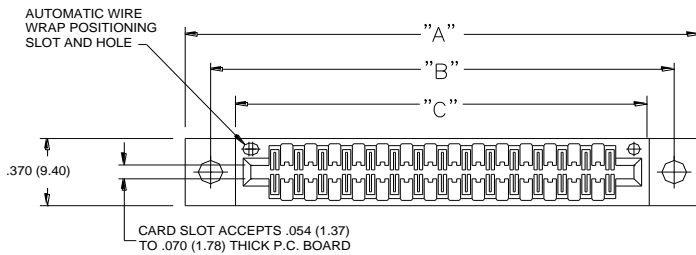

CONNECTOR MOUNTING PATTERN

IN-CONTACT POLARIZING KEY

P/N 345-240-328



BETWEEN CONTACT POLARIZING KEY

P/N 306-240-318



SECTIONS THROUGH CONTACT POSITION

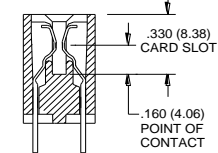
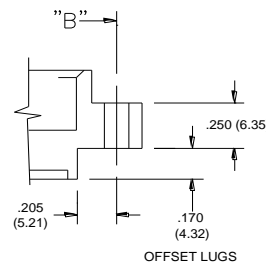

DUAL ROW

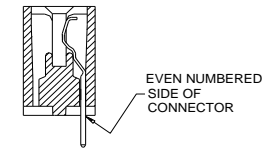

SINGLE ROW

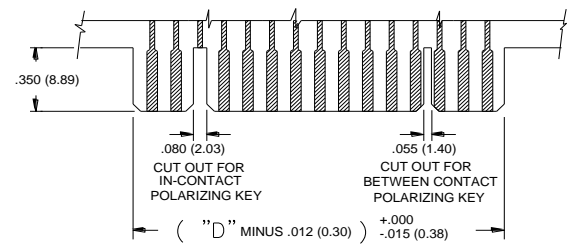

RECOMMENDED DAUGHTER BOARD

NUMBER OF CONTACTS		"A"		"B"		"C"		"D"		"E"	
Single	Double	Inch	mm	Inch	mm	Inch	mm	Inch	mm	Inch	mm
5	10	1.435	36.45	1.170	29.72	0.910	23.11	1.435	36.45	0.500	12.70
6	12	1.560	39.62	1.295	32.89	1.035	26.29	1.560	39.62	0.625	15.88
10	20	2.060	52.32	1.795	45.59	1.535	38.99	2.060	52.32	1.125	28.58
15	30	2.685	68.20	2.420	61.47	2.160	54.86	2.685	68.20	1.750	44.45
18	36	3.060	77.72	2.795	70.99	2.535	64.39	3.060	77.72	2.125	53.98
22	44	3.560	90.42	3.295	83.69	3.035	77.09	3.560	90.42	2.625	66.68
25	50	3.935	99.95	3.670	93.22	3.410	86.61	3.935	99.95	3.000	76.20
30	60	4.560	115.82	4.295	109.09	4.035	102.49	4.560	115.82	3.625	92.08
31	62	4.685	119.00	4.420	112.27	4.160	105.66	4.685	119.00	3.750	95.25
35	70	5.185	131.70	4.920	124.97	4.660	118.36	5.185	131.70	4.250	107.95
36	72	5.310	134.87	5.045	128.14	4.785	121.54	5.310	134.87	4.375	111.13
40	80	5.810	147.57	5.545	140.84	5.285	134.24	5.810	147.57	4.875	123.83
43	86	6.185	157.10	5.920	150.37	5.660	143.76	6.185	157.10	5.250	133.35
50	100	7.060	179.32	6.795	172.59	6.535	165.99	7.060	179.32	6.125	155.58

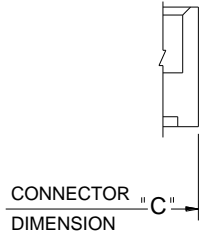

MOUNTING OPTION
CODE x01
(NO MOUNTING LUGS)

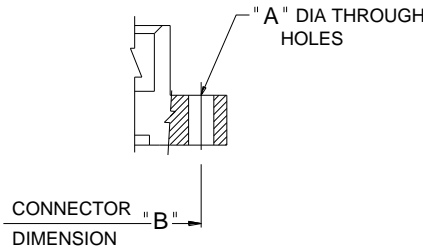

MOUNTING OPTION
CODES x02 AND x04
(THROUGH MOUNTING HOLES)

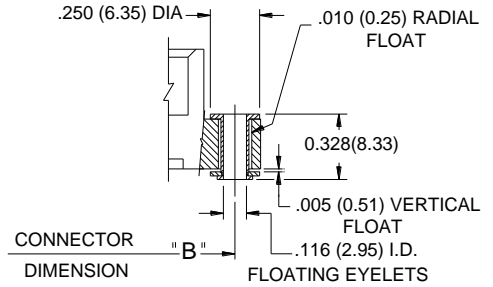

MOUNTING OPTION
CODE x03
(FLOATING EYELETS)

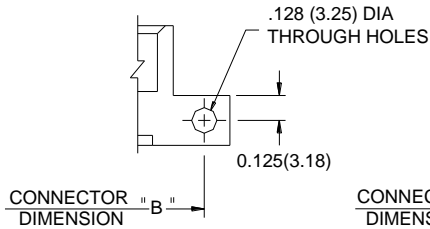

MOUNTING OPTION
CODE x12
(SIDE MOUNTING HOLES)
WITH INSERTS: CODES X17 & X18,
SEE TABLE

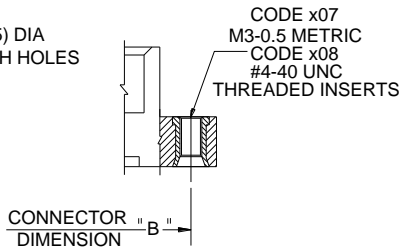

MOUNTING OPTION
CODES x07 & x08
(THREADED INSERTS)

CODE X02 AND X04- THROUGH MTG. HOLES		
	CODE X02	CODE X04
"A" DIA.	0.128(3.25)	0.156(3.96)
CODE X07 AND X08- THREADED INSERTS		
	CODE X07	CODE X08
INSERT	M3-0.5(METRIC)	#4-40 UNC
SIDE MOUNTING HOLES WITH INSERTS		
	CODE X17	CODE X18
INSERT	M3-0.5(METRIC)	#4-40 UNC

