

PRODUCT NUMBER  
SEE TABLE

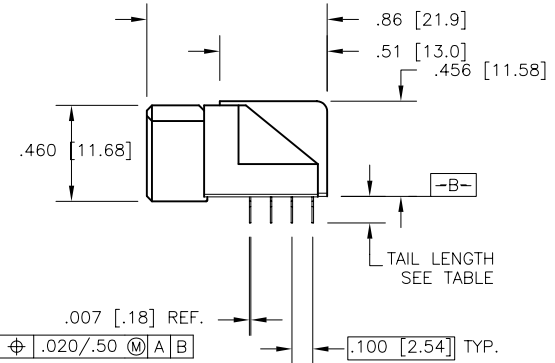
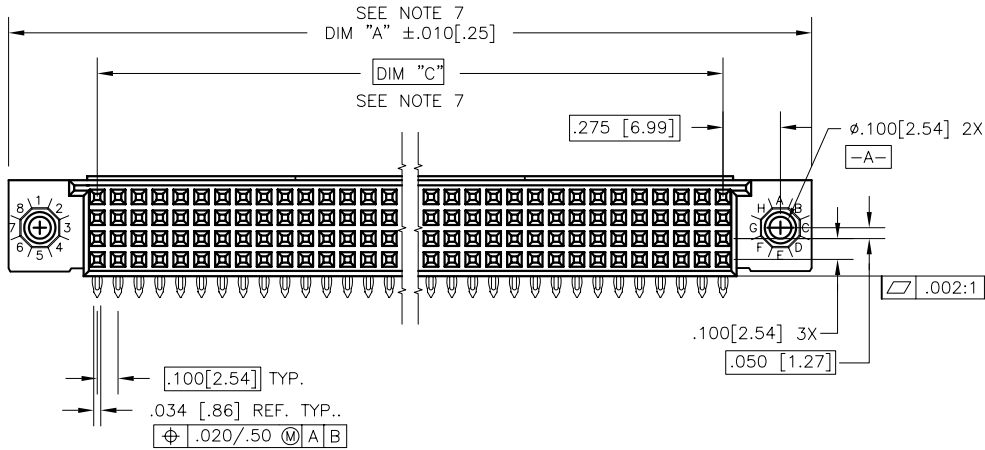
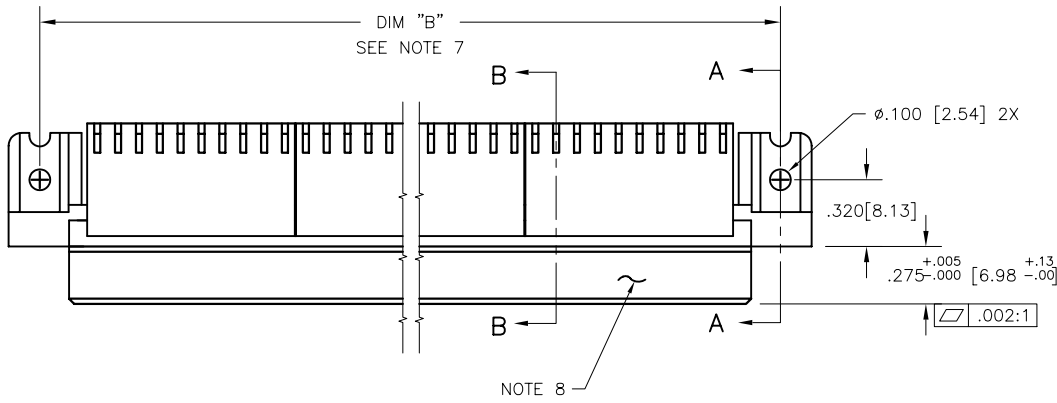

Copyright FCI

mat'l. code		surface		tolerance		projection		product family	
NOTE 3		ISO 1302		ISO 406		ISO 1101		HPC	
ltr	ecm no	dr	date	tolerances unless otherwise specified		INCH/MM		title	
P	V10824	JRW	2/6/01	angles	linear	.XX±.01/XX±.03		4 ROW R/A RECEPTACLE	
R	V05-0460	DAI	7/13/05			.XXX±.005/XX±.013		PRESS FIT	
S	V05-1003	DAI	11/1/05	0°±2'		.XXXX±.0020/XXX±0.05		scale 1:1	
T	V05-1041	HTB	11/14/05	dr	D.INGRAM	7/13/05		dwg no	
U	M06-0255	MHT	7/06/06	engr	D.HORCHLER	7/13/05		sheet 1 of 7 size	
V	M06-0388	MHT	10/04/06	chr	T.BREWBAKER	7/13/05		50642	
W	M08-0149	MHT	5/27/08	appd	D.HORCHLER	7/13/05		A3	
sheet	revision	W	W	W	W	W	W	type	
index	sheet	1	2	3	4	5	6	Product Customer Drawing	

PRODUCT NUMBER  
SEE TABLE

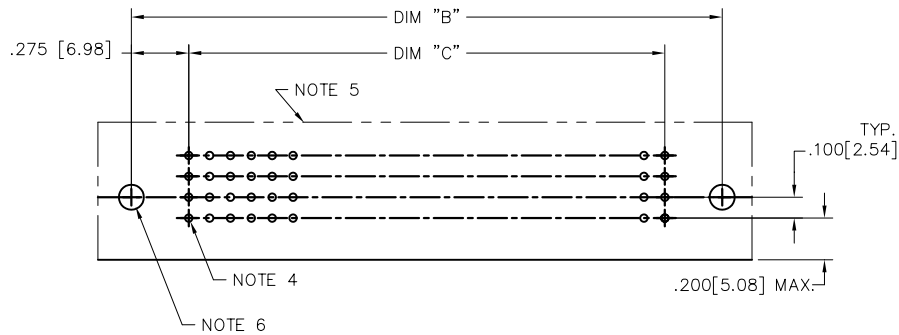
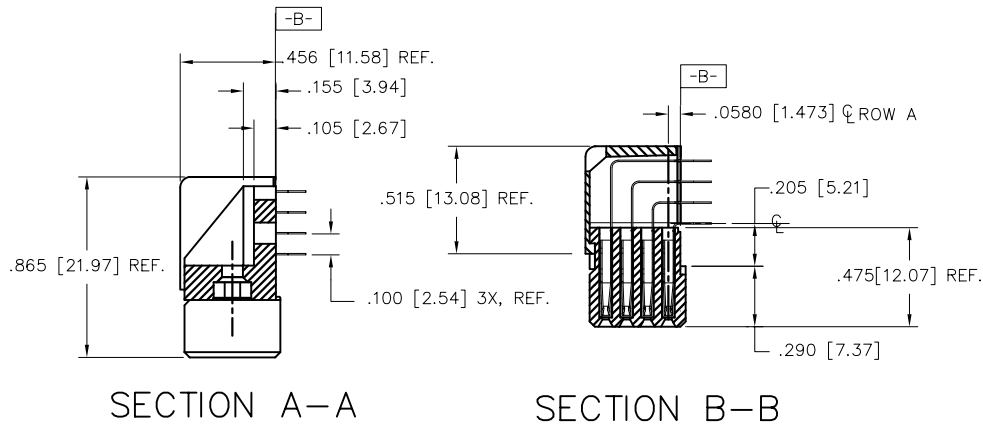

RECOMMENDED PCB LAYOUT  
(ALL HOLES LOCATED ON .100[2.54]  
GRID UNLESS OTHERWISE SHOWN)

mat'l. code		surface		tolerance		projection		product family	
NOTE 3		ISO 1302		ISO 406 ISO 1101				HPC	
ltr	ecn no	dr	date	tolerances unless otherwise specified		INCH/MM		title	
W				angles	linear	scale 1:1		4 ROW R/A RECEPTACLE PRESS FIT	
				0°±2°				dwg no	
				dr	D.INGRAM	7/13/05			sheet 2 of 7 size
				enr	D.HORCHLER	7/13/05	50642		A3
				chr	T.BREWBAKER	7/13/05	type		Product Customer Drawing
				appd	D.HORCHLER	7/13/05			
sheet	revision								
index	sheet								

PRODUCT NUMBER  
SEE TABLE

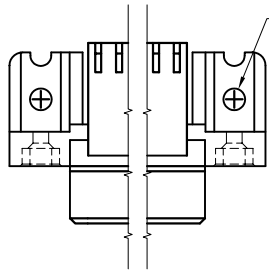

Ø.104 [Ø2.64]

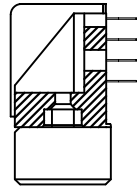

SECTION A-A

SPECIAL FEATURE OPTION A  
SEE NOTE 6

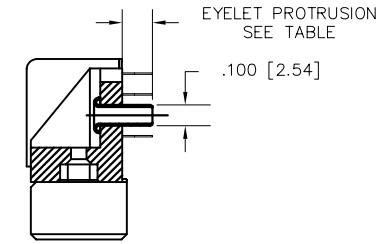
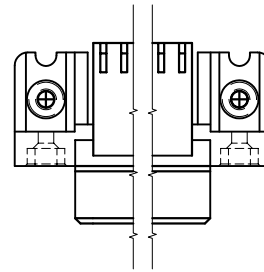

SECTION A-A

SPECIAL FEATURE OPTION B  
SEE NOTE 6

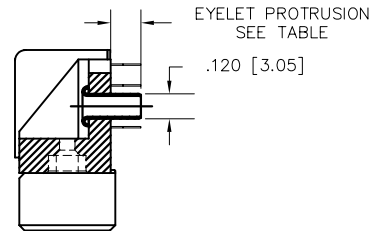
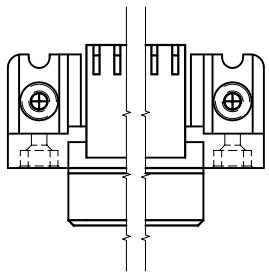

SECTION A-A

SPECIAL FEATURE OPTION C  
SEE NOTE 6

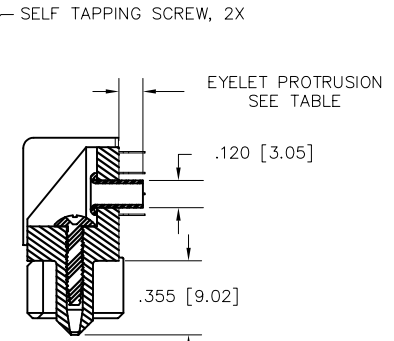
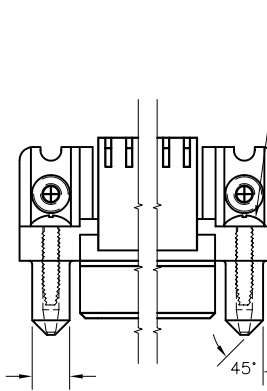

SECTION A-A

SPECIAL FEATURE OPTION D  
SEE NOTE 6

FCJ  
FCconnect.com

Copyright FCJ

mat'l. code		surface		tolerance		projection		product family	
NOTE 3		ISO 1302		ISO 406 ISO 1101				HPC	
ltr	ecm no	dr	date	tolerances unless otherwise specified					
W				angles	linear			title	
				0°±2°	$.XX\pm.01/XX\pm.03$ $.XXX\pm.005/XX\pm.013$ $.XXXX\pm.0020/XXX\pm.005$	scale 1:1		4 ROW R/A RECEPTACLE PRESS FIT	
		dr	D.INGRAM	7/13/05					
		engr	D.HORCHLER	7/13/05					
		chr	T.BREWBAKER	7/13/05					
		appd	D.HORCHLER	7/13/05					
sheet	revision	dwg no							
index	sheet	sheet 3 of 7 size							
		50642							
		A3							
		type Product Customer Drawing							

PRODUCT NUMBER  
SEE TABLE

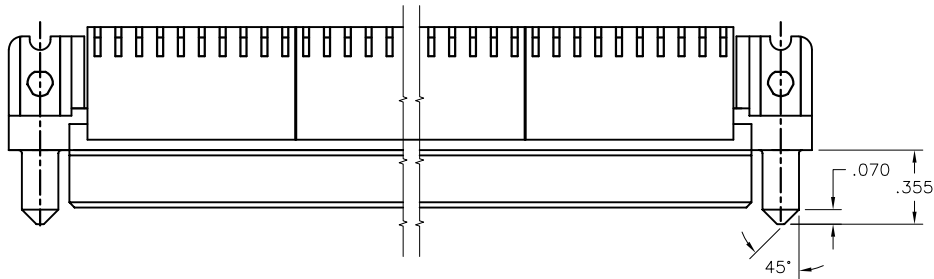

SPECIAL FEATURE OPTION E  
SEE NOTE 6

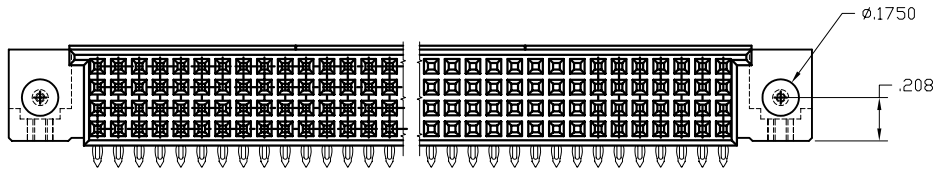

Copyright FCJ

mat'l. code		surface		tolerance		projection		product family	
NOTE 3		ISO 1302		ISO 406 ISO 1101				HPC	
ltr	ecn no	dr	date	tolerances unless otherwise specified		INCH/MM		title	
				angles	linear	$.XX \pm .01 / X \pm 0.3$ $.XXX \pm .005 / XX \pm 0.13$ $.XXXX \pm .0020 / XXX \pm 0.05$		4 ROW R/A RECEPTACLE PRESS FIT	
				$0^\circ \pm 2'$		scale 1:1		dwg no	
				dr	D. INGRAM	7/13/05		sheet 4 of 7 size	
				engr	D. HORCHLER	7/13/05		50642	
				chr	T. BREWBAKER	7/13/05		A3	
				appd	D. HORCHLER	7/13/05		type	
sheet index		revision sheet						Product Customer Drawing	



PRODUCT NUMBER	NUMBER OF POSITIONS NOTE 2	TAIL LENGTH	SPECIAL FEATURES SEE NOTE 6	SOLDER TAIL PLATING	CONTACT PLATING	EYELET PROTRUSION	GUIDE PINS
50642-1YYYE	YYY	.125±.010/3.18±.25	-	TIN LEAD	30u"/.76u Au	N/A	NONE
50642-1YYYELF	YYY	.125±.010/3.18±.25	-	TIN	30u"/.76u GXT	N/A	NONE
50642-1YYYEA	YYY	.125±.010/3.18±.25	"A"	TIN LEAD	30u"/.76u Au	N/A	NONE
50642-1YYYEALF	YYY	.125±.010/3.18±.25	"A"	TIN	30u"/.76u GXT	N/A	NONE
50642-1YYYEB	YYY	.125±.010/3.18±.25	"B"	TIN LEAD	30u"/.76u Au	.145/3.68	NONE
50642-1YYYEBLF	YYY	.125±.010/3.18±.25	"B"	TIN	30u"/.76u GXT	.145/3.68	NONE
50642-1YYYEC	YYY	.125±.010/3.18±.25	"C"	TIN LEAD	30u"/.76u Au	.115/2.92	NONE
50642-1YYYECLF	YYY	.125±.010/3.18±.25	"C"	TIN	30u"/.76u GXT	.115/2.92	NONE
50642-1YYYED	YYY	.125±.010/3.18±.25	"D"	TIN LEAD	30u"/.76u Au	.115/2.92	2
50642-1YYYEDLF	YYY	.125±.010/3.18±.25	"D"	TIN	30u"/.76u GXT	.115/2.92	2
50642-1YYYEE	YYY	.125±.010/3.18±.25	"E"	TIN LEAD	30u"/.76u Au	N/A	2
50642-1YYYEELF	YYY	.125±.010/3.18±.25	"E"	TIN	30u"/.76u GXT	N/A	2
50642-1YYYF	YYY	.145±.010/3.68±.25	-	TIN LEAD	30u"/.76u Au	N/A	NONE
50642-1YYYFLF	YYY	.145±.010/3.68±.25	-	TIN	30u"/.76u GXT	N/A	NONE
50642-1YYYFA	YYY	.145±.010/3.68±.25	"A"	TIN LEAD	30u"/.76u Au	N/A	NONE
50642-1YYYFALF	YYY	.145±.010/3.68±.25	"A"	TIN	30u"/.76u GXT	N/A	NONE
50642-1YYYFC	YYY	.145±.010/3.68±.25	"C"	TIN LEAD	30u"/.76u Au	.145/3.68	NONE
50642-1YYYFCLF	YYY	.145±.010/3.68±.25	"C"	TIN	30u"/.76u GXT	.145/3.68	NONE
50642-1YYYFD	YYY	.145±.010/3.68±.25	"D"	TIN LEAD	30u"/.76u Au	.145/3.68	2
50642-1YYYFDLF	YYY	.145±.010/3.68±.25	"D"	TIN	30u"/.76u GXT	.145/3.68	2
50642-1YYYFE	YYY	.145±.010/3.68±.25	"E"	TIN LEAD	30u"/.76u Au	N/A	2
50642-1YYYFELF	YYY	.145±.010/3.68±.25	"E"	TIN	30u"/.76u GXT	N/A	2
50642-XX004	240	.125±.010/3.18±.25	SEE SHEET 5	TIN LEAD	30u"/.76u Au	N/A	NONE
50642-XX004LF	240	.125±.010/3.18±.25	SEE SHEET 5	TIN	30u"/.76u GXT	N/A	NONE



FCIconnect.com

Copyright FCI

mat'l. code		surface		tolerance		projection		product family	
NOTE 3		ISO 1302		ISO 406 ISO 1101				HPC	
ltr	ecr no	dr	date	tolerances unless otherwise specified		INCH/MM		title	
W				angles	linear	scale 1:1		4 ROW R/A RECEPTACLE PRESS FIT	
				0°±2°	.XX±.01/XX±0.3 .XXX±.005/XX±0.13 .XXXX±.0020/XXX±0.05			dwg no 50642 sheet 6 of 7 size A3	
				dr	D.INGRAM	7/13/05		type Product Customer Drawing	
				enr	D.HORCHLER	7/13/05			
				chr	T.BREWBAKER	7/13/05			
				appd	D.HORCHLER	7/13/05			
sheet index	revision sheet								

PRODUCT NUMBER  
SEE TABLE

NOTES:

①. PRODUCT NUMBERING CODE

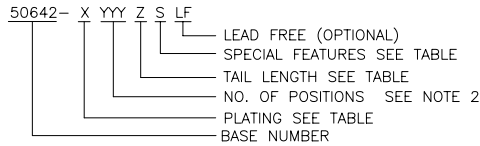

PRODUCT NUMBERING CODE FOR SELECT LOAD

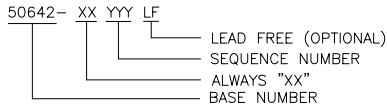

- ②. THIS PRODUCT IS CONFIGURED IN SIZES OF 6 THRU 80 COLUMNS IN INCREMENTS OF ONE, i.e. 6, 7, 8, 9, .....79, 80.
- ③. MATERIAL: PRESS BLOCK – HIGH TEMP THERMOPLASTIC;  
HOUSING—GLASS AND MINERAL FILLED HIGH TEMPERTURE THERMOPLASTIC, FLAME RETARDANT PER UL94V-0. COLOR—BLACK  
CONTACT—BeCu
- ④. DRILLED HOLE DIA OF .0453±.001 INCH FINISHED TO .0400±.0030 INCH BY PLATING SnPb OR OTHER PLATING 0.0003 TO 0.0006 INCHES THICK WITH A COPPER UNDERPLATE AS NEEDED.
- ⑤. INFORMATION DOCUMENT: FOR PCB STAY- AWAY ZONE, SEE TA-0954.
- ⑥. SPECIAL FEATURES (SEE PRODUCT NUMBER TABLE, AND DETIALS ON SHEET 3)  
- IF NO SPECIAL FEATURE CODE IS SELECTED, PCB MOUNTING HOLE DIMENSION TO BE  $\phi.120\pm.003[3.05\pm0.07]$   
"A" PCB MOUNTING HOLE DIMENSION TO BE  $\phi.100\pm.003[2.54\pm0.07]$   
"B" INCLUDES PRE-INSTALLED EYELETS FOR PCB ATTACHMENT IN A  $\phi.100\pm.003[2.54\pm0.07]$  MOUNTING HOLE. (E TAIL ONLY)  
"C" INCLUDES PRE-INSTALLED EYELETS FOR PCB ATTACHMENT IN A  $\phi.120\pm.003[3.05\pm0.07]$  MOUNTING HOLE.  
"D" INCLUDES PRE-INSTALLED EYELETS WITH MOLDED GUIDE PINS FOR PCB ATTACHMENT IN A  $\phi.120\pm.003[3.05\pm0.07]$  MOUNTING HOLE.  
"E" INCLUDES MOLDED GUIDE PINS WITH TRI-HOLE SHAPED MOUNTING HOLES. (EYELETS NOT INSTALLED)
- ⑦. LENGTH CALCULATIONS:  
DIMENSION "A" CALCULATION =  $.100 [2.54] \times \text{NO. OF COLUMNS} + .75 [19.1]$   
DIMENSION "B" CALCULATION =  $.100 [2.54] \times \text{NO. OF COLUMNS} + .450[11.43]$   
DIMENSION "C" CALCULATION =  $.100 [2.54] \times \text{NO. OF COLUMNS} - .100[2.54]$
- ⑧. MANUFACTURE'S LOGO, PN, AND LOT CODE TO APPEAR ON THIS SURFACE.
9. THIS PRODUCT (WITH "LF" SUFFIX) MEETS EUROPEAN UNION DIRECTIVES AND OTHER COUNTRY REGULATIONS AS DESCRIBED IN GS-22-008.
10. THIS HOUSING WILL WITHSTAND EXPOSURE TO 260°C PEAK TEMPERTURE FOR 10-30 SECONDS IN A CONVECTION, INFRA-RED OR VAPOR PHASE REFLOW OVEN.
11. ALL POSITIONS ARE LOADED EXCEPT FOR -XXXXY ASSEMBLIES WHICH HAVE SELECTIVE LOADING.

mat'l. code NOTE 3		surface ISO 1302	tolerance ISO 406 ISO 1101	projection 	product family HPC
ltr	ecn no	dr	date	tolerances unless otherwise specified	title 4 ROW R/A RECEPTACLE PRESS FIT
w				angles linear 0°±2'	INCH/MM scale 1:1
				dr D.INGRAM 7/13/05	dwg no 50642
				enr D.HORCHLER 7/13/05	sheet 7 of 7 size A3
				chr T.BREWBAKER 7/13/05	type Product Customer Drawing
				appd D.HORCHLER 7/13/05	
sheet	revision				
index	sheet				



Copyright FCI

# Mouser Electronics

Authorized Distributor

Click to View Pricing, Inventory, Delivery & Lifecycle Information:

FCI:

[50642-1100EBLF](#) [50642-1240EB](#)