

THIS DOCUMENT IS THE PROPERTY OF
KEYSTONE ELECTRONICS CORP. AND
SHALL NOT BE REPRODUCED, DISTRIBUTED
OR USED AS A BASIS FOR MANUFACTURE
WITHOUT PRIOR WRITTEN PERMISSION
FROM KEYSTONE ELECTRONICS CORP.

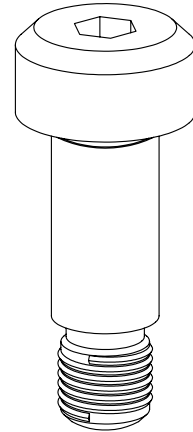
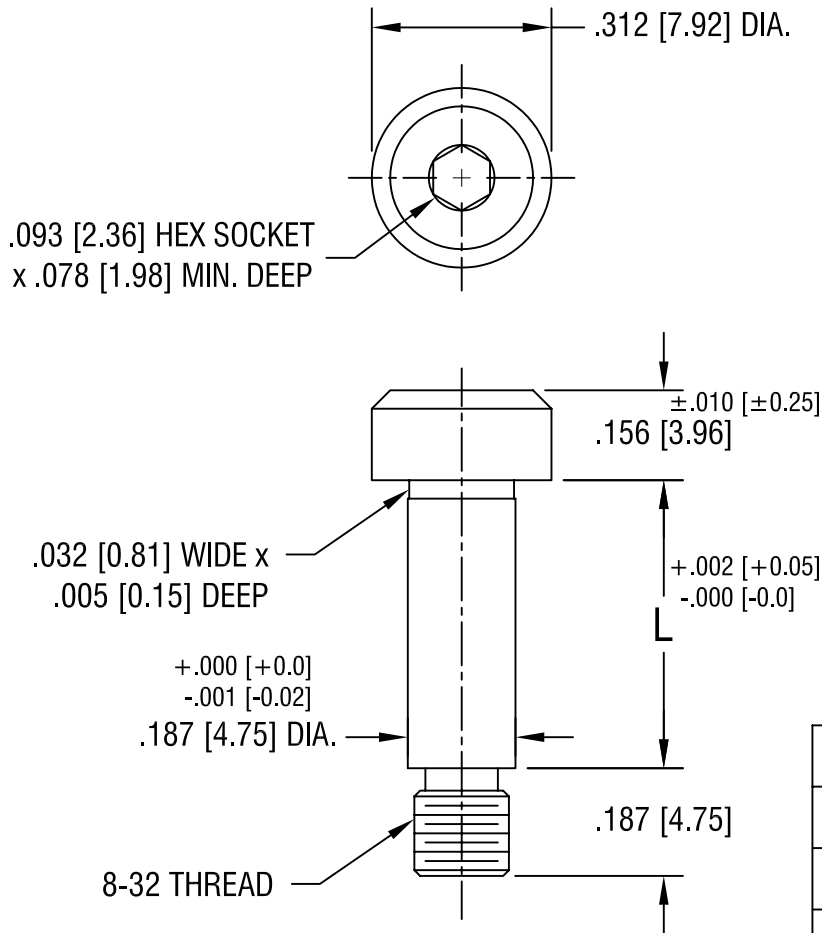

PART NO.	'L' DIM.
2451	.125 [3.17]
2452	.250 [6.35]
2453	.375 [9.52]
2454	.500 [12.70]
2455	.625 [15.87]
2456	.750 [19.05]
2457	1.000 [25.40]

KEYSTONE ELECTRONICS CORP.

ASTORIA, N.Y. 11105-2017

PART NAME		SHOULDER SCREW - SOCKET	
MATERIAL		STAINLESS STEEL	
FINISH	-	DRN BY	BOONE
		APP'D	LN
		DATE	8.16.95
		SCALE	3X
TOLERANCES	INCH [MM]	CODE	DWG NO.
DECIMAL	± .005 [± 0.15]	C/M	2451-2457
ANGULAR	± 1°		
UNLESS OTHERWISE SPECIFIED			

7.15.08	CHANGE AS PER ECN 08-120	B
11.14.07	CHANGE AS PER ECN 07-079	A
DATE	DESCRIPTION	REV.

Mouser Electronics

Authorized Distributor

Click to View Pricing, Inventory, Delivery & Lifecycle Information:

[Keystone Electronics:](#)

[2454](#)