

Contact Dimensions:

**521-P.C. Tail .025 Sq.(0.64 Sq.) - Tail LG=.150(3.81)
 .100 (2.54) Contact Spacing x .200 (5.08) Row Spacing**

THIS IS A C.A.D. GENERATED DRAWING
 DO NOT MAKE MANUAL REVISIONS TO MASTER



ISSUE NUMBER

ORIGINAL

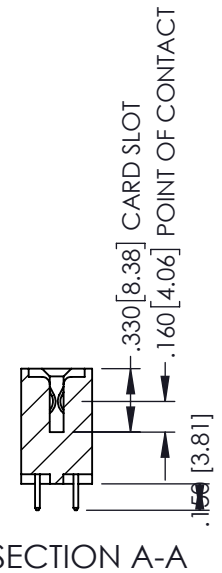
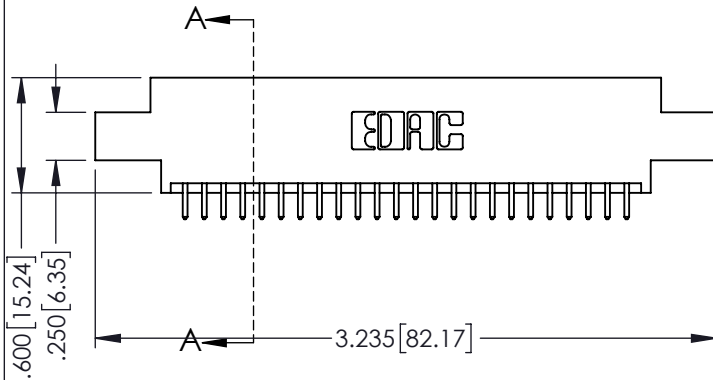
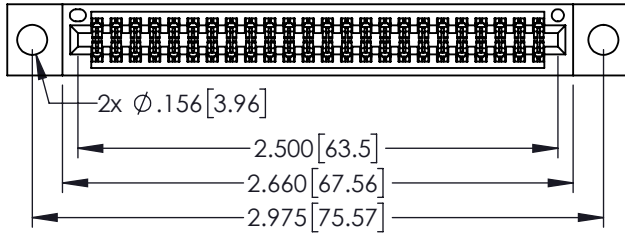

- INSULATOR MATERIAL: THERMOPLASTIC PBT BLACK, UL 94V-0
- CONTACT MATERIAL; COPPER TIN ALLOY
- CONTACT PLATING: GOLD ON THE MATING AREA, TIN PLATING ON THE CONTACT TAILS, NICKEL UNDERPLATE

**345/395 SERIES CARD EDGE CONNECTOR
 PART NUMBER: 395-048-521-804**



YOUR CONNECTION TO QUALITY & SERVICE

EDAC INC
 TORONTO, ONTARIO
 CANADA

THESE DRAWINGS AND SPECIFICATIONS
 ARE THE PROPERTY OF EDAC INC. AND
 SHALL NOT BE REPRODUCED, OR COPIED
 OR USED AS THE BASIS FOR THE
 MANUFACTURE OR SALE OF APPARATUS
 WITHOUT WRITTEN PERMISSION.

ACAD REFERENCE NO. 345-ENG-MASTER	
DRAWN: R.STA.MONICA	DATE MAY.16/2017
CHECKED:	DATE:
SCALE: 1:1	SHEET 1 OF 2
DRAWING NUMBER 345-ENG-MASTER	ISSUE 1

Contact Description:
559-90 Degree Bend (Code 541 Contacts)

THIS IS A C.A.D. GENERATED DRAWING
 DO NOT MAKE MANUAL REVISIONS TO MASTER



ISSUE NUMBER

ORIGINAL



Contact Code 555



Contact Code 556

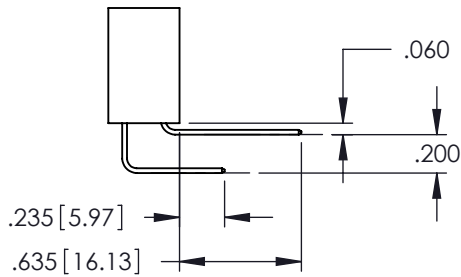

Contact Code 558

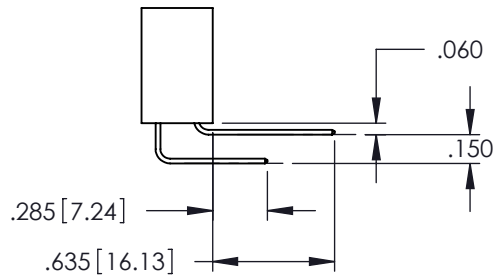

Contact Code 559



Contact Code 560

- INSULATOR MATERIAL: THERMOPLASTIC POLYESTER, UL 94V-0
- DAP MATERIAL AVAILABLE UPON REQUEST
- CONTACT MATERIAL: COPPER ALLOY
- CONTACT PLATING: GOLD ON THE MATING AREA, TIN PLATING ON THE CONTACT TAILS, NICKEL UNDERPLATE

**345/395 SERIES CARD EDGE CONNECTOR
 CONTACT CODE 555,556,558,559,560 DIMENSIONS**



EDAC INC
 TORONTO, ONTARIO
 CANADA

YOUR CONNECTION TO QUALITY & SERVICE

THESE DRAWINGS AND SPECIFICATIONS
 ARE THE PROPERTY OF EDAC INC. AND
 SHALL NOT BE REPRODUCED, OR COPIED
 OR USED AS THE BASIS FOR THE
 MANUFACTURE OR SALE OF APPARATUS
 WITHOUT WRITTEN PERMISSION.

ACAD REFERENCE NO. 345-ENG-MASTER

DRAWN: R.STA.MONICA DATE: MAY.16/2017

CHECKED: DATE:

SCALE: 1:1 SHEET 2 OF 2

DRAWING NUMBER 345-ENG-MASTER ISSUE 1