

Welded - "Contempra" Rack Cabinet Frames (C2F Series)

Features:

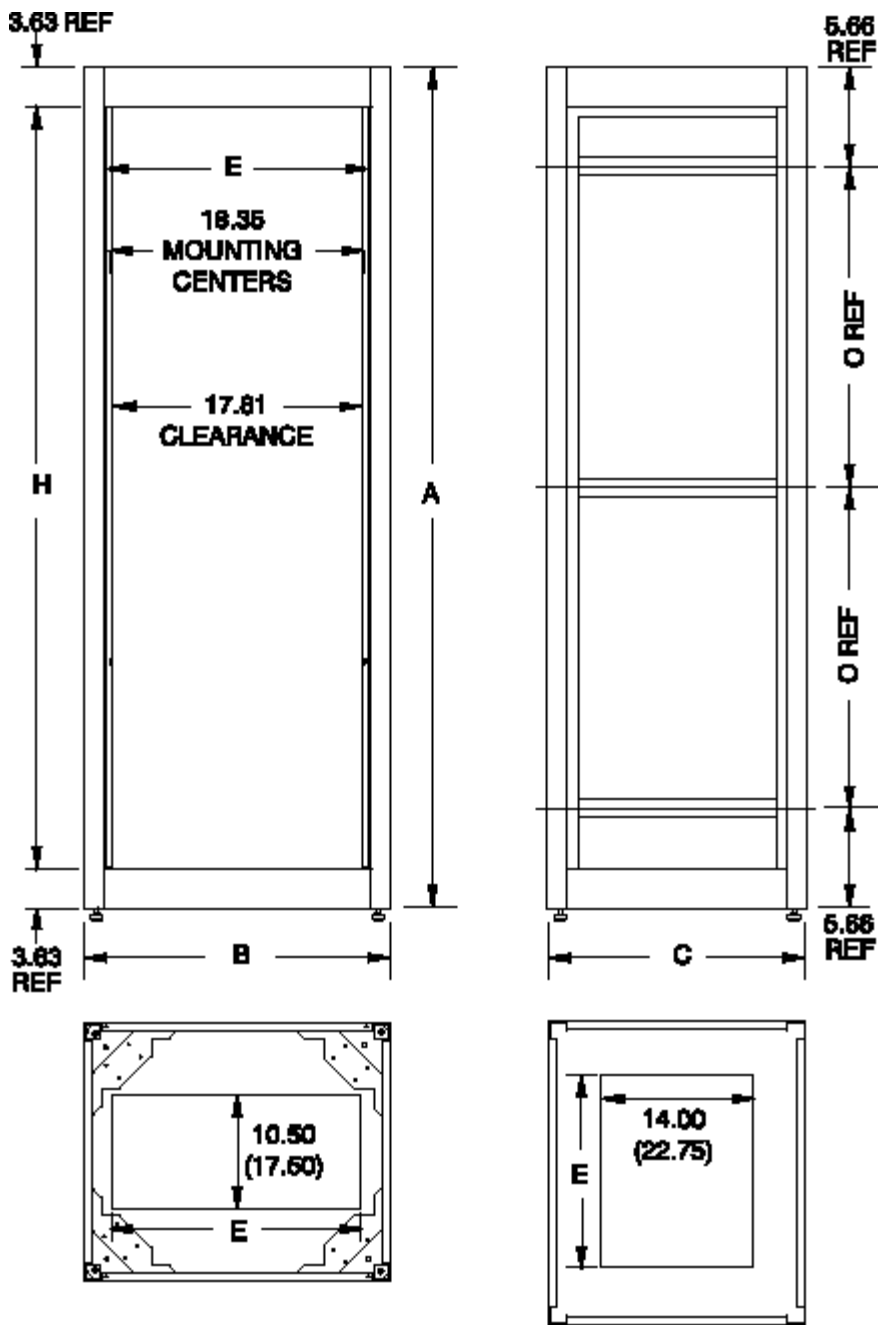

- Heavy duty - welded rack (1,500 lb even load rating)...
- Standard 19" panel width (23" overall)...
- Choice of three depths:
 1. usable depth of 21.63" (23.63" overall)
 2. usable depth of 29.50" (31.50" overall)
 3. usable depth of 34.00" (36.00" overall)
- Unit is shipped as welded frame only with 4 levelling feet...
-  **Panel rails are NOT included** - to maximize rail options (see accessories listed below or link here [to rails](#))...
- Save time & money, link here ([C2RR series](#)) to our assembled "**Rapid Rack**" version, complete with our most popular accessories...
- Heavy duty: 14 gauge steel frame (black or grey/beige)...
- Recommended maximum weight (C2F247836 tested) - 1,500 pounds...
- Finished in a rugged, textured powder paint...
- See frame [accessories below](#).



23.63" Deep models:
Usable Depth = 21.63"

Part Number	Color	Drawing File Size	.zip File Size	Panel Height		Overall Dimensions (Inches)			
				Inches	Units	A	B	C	H
C2F193523BK1 C2F193523CG1	Black Gray/Beige	130K	55K	35	20	42.31	23	23.63	35.06
C2F194223BK1 C2F194223CG1	Black Gray/Beige	135K	57K	42	24	49.31	23	23.63	42.06
C2F194923BK1 C2F194923CG1	Black Gray/Beige	139K	59K	49	28	56.31	23	23.63	49.06
C2F195623BK1 C2F195623CG1	Black Gray/Beige	145K	62K	56	32	63.31	23	23.63	56.06
C2F196323BK1 C2F196323CG1	Black Gray/Beige	144K	63K	63	36	70.31	23	23.63	63.06

C2F195636CG1	Gray/Beige		141K		64K	56	32	63.31	23	36	56.06
C2F196336BK1 C2F196336CG1	Black Gray/Beige		145K		65K	63	36	70.31	23	36	63.06
C2F197036BK1 C2F197036CG1	Black Gray/Beige		149K		67K	70	40	77.31	23	36	70.06
C2F197836BK1 C2F197836CG1	Black Gray/Beige		154K		68K	78.75	45	86.06	23	36	78.81
C2F198536BK1 C2F198536CG1	Black Gray/Beige		157K		70K	85.75	49	93.06	23	36	85.81



PART No. C2F196323

Isometric drawing not to scale

CCR TAPPED RAILS NOT INCLUDED

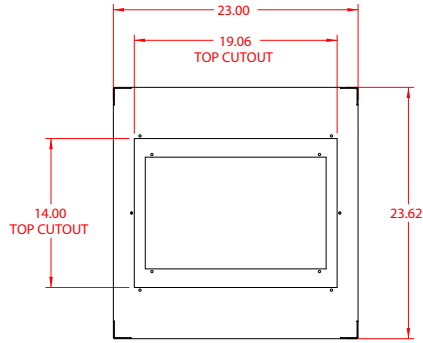
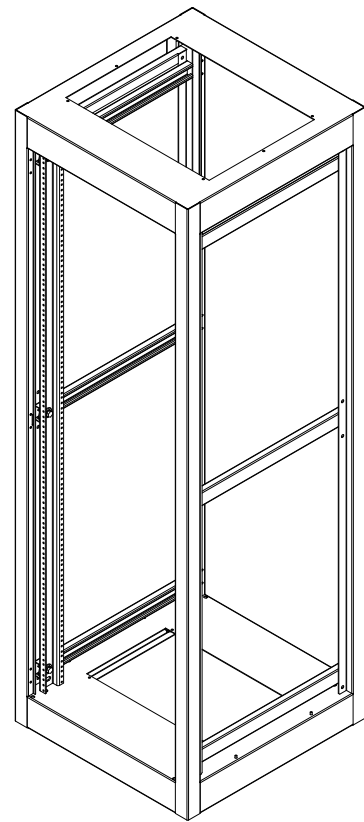

TOP VIEW

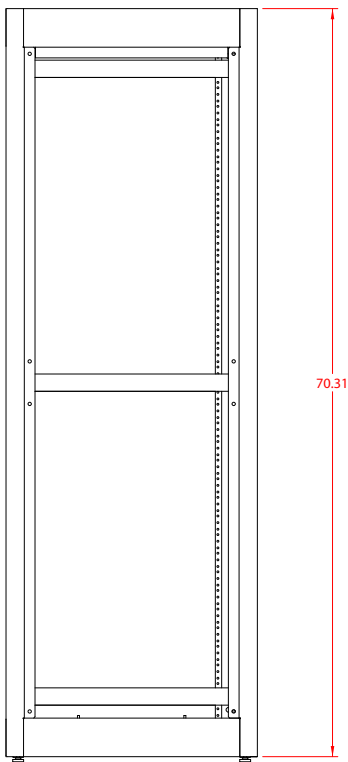

L.S. VIEW

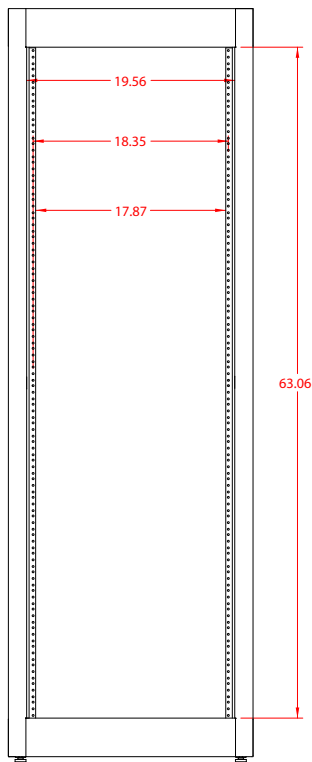

FRONT VIEW

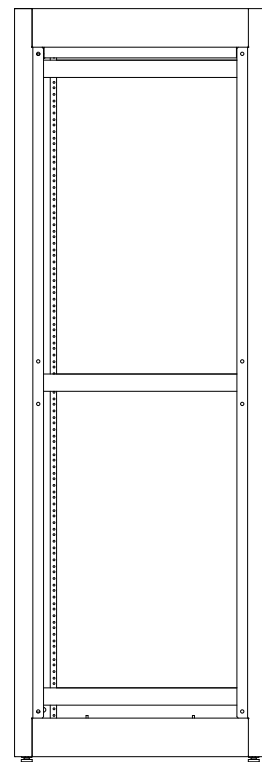

R.S. VIEW

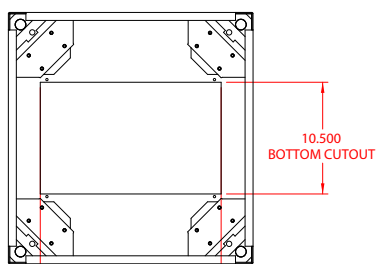

BOTTOM VIEW

FEATURES

- Heavy duty, welded 14 guage steel rack frame
- Recommended maximum weight (C2F247836 tested) - 1,500 pounds
- Standard 19" panel mount width (23" overall width)
- For 19" extra wide, 23" and 24" rack mount cabinets for vertical cable management applications see page 56
- Choice of three depths (23.6", 31.5" or 36")
- Unit is shipped as a welded frame only with 4 levelling feet
- **Panel rails are NOT included** allows maximum flexibility of panel rails, quantity & options (ie..tapped or square hole) see page 45 for options.
- Finished in a rugged, textured powder paint finish
- Welded frame bottom includes caster mounts
- See ordering guide (next page)

23.63" Deep (Usable Depth = 21.63")

Part Number		Dimensions (Inches)									
		Panel Height		Overall			Top Cutout		Bottom Cutout		Strut Spacing
				Height	Width	Depth	Depth	Width	Depth	Width	
Black Textured	Beige Textured	C	Units	A	B	D	E	F	G	H	K
C2F193523BK1	C2F193523CG1	35.06	20	42.31	23	23.63	14	19	10.5	17	N/A
C2F194223BK1	C2F194223CG1	42.06	24	49.31	23	23.63	14	19	10.5	17	19.00
C2F194923BK1	C2F194923CG1	49.06	28	56.31	23	23.63	14	19	10.5	17	22.50
C2F195623BK1	C2F195623CG1	56.06	32	63.31	23	23.63	14	19	10.5	17	26.00
C2F196323BK1	C2F196323CG1	63.06	36	70.31	23	23.63	14	19	10.5	17	29.50
C2F197023BK1	C2F197023CG1	70.06	40	77.31	23	23.63	14	19	10.5	17	33.00
C2F197823BK1	C2F197823CG1	78.81	45	86.06	23	23.63	14	19	10.5	17	37.38
C2F198523BK1	C2F198523CG1	85.81	49	93.06	23	23.63	14	19	10.5	17	40.88

31.5" Deep (Usable Depth = 29.5")

Part Number		Dimensions (Inches)									
		Panel Height		Overall			Top Cutout		Bottom Cutout		Strut Spacing
				Height	Width	Depth	Depth	Width	Depth	Width	
Black Textured	Beige Textured	C	Units	A	B	D	E	F	G	H	K
C2F193531BK1	C2F193531CG1	35.06	20	42.31	23	31.50	22.75	19	17.5	17	N/A
C2F194231BK1	C2F194231CG1	42.06	24	49.31	23	31.50	22.75	19	17.5	17	19.00
C2F194931BK1	C2F194931CG1	49.06	28	56.31	23	31.50	22.75	19	17.5	17	22.50
C2F195631BK1	C2F195631CG1	56.06	32	63.31	23	31.50	22.75	19	17.5	17	26.00
C2F196331BK1	C2F196331CG1	63.06	36	70.31	23	31.50	22.75	19	17.5	17	29.50
C2F197031BK1	C2F197031CG1	70.06	40	77.31	23	31.50	22.75	19	17.5	17	33.00
C2F197831BK1	C2F197831CG1	78.81	45	86.06	23	31.50	22.75	19	17.5	17	37.38
C2F198531BK1	C2F198531CG1	85.81	49	93.06	23	31.50	22.75	19	17.5	17	40.88

36" Deep (Usable Depth = 34")

Part Number		Dimensions (Inches)									
		Panel Height		Overall			Top Cutout		Bottom Cutout		Strut Spacing
				Height	Width	Depth	Depth	Width	Depth	Width	
Black Textured	Beige Textured	C	Units	A	B	D	E	F	G	H	K
C2F193536BK1	C2F193536CG1	35.06	20	42.31	23	36	27.25	19	17.5	17	N/A
C2F194236BK1	C2F194236CG1	42.06	24	49.31	23	36	27.25	19	17.5	17	19.00
C2F194936BK1	C2F194936CG1	49.06	28	56.31	23	36	27.25	19	17.5	17	22.50
C2F195636BK1	C2F195636CG1	56.06	32	63.31	23	36	27.25	19	17.5	17	26.00
C2F196336BK1	C2F196336CG1	63.06	36	70.31	23	36	27.25	19	17.5	17	29.50
C2F197036BK1	C2F197036CG1	70.06	40	77.31	23	36	27.25	19	17.5	17	33.00
C2F197836BK1	C2F197836CG1	78.81	45	86.06	23	36	27.25	19	17.5	17	37.38
C2F198536BK1	C2F198536CG1	85.81	49	93.06	23	36	27.25	19	17.5	17	40.88

19" Rack Mount

Welded