

Capacitor, ceramic, 1500 pF, +/-20% Tol, 400 V, Y5V, Lead Spacing=7.5 mm

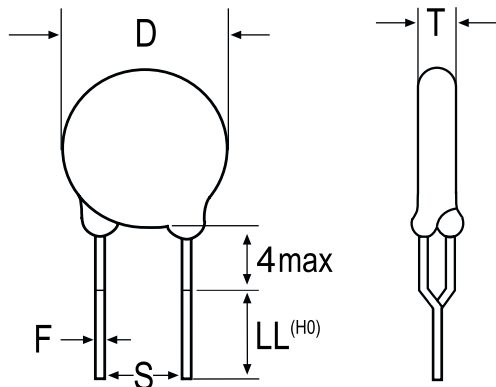

General Information	
Supplier:	KEMET
Application:	Safety:X1/Y2
Temperature Coefficient:	Y5V
Body Type:	Radial Disc
Lead Form:	vcrimp
Termination Type:	Tin (Sn)
RoHS:	Yes
Halogen Free:	Yes

Dimensions (mm)		
Symbol	Dimension	Tolerance
D	7	MAX
T	5	MAX
S	7.5	+/-1
LL	18	+2/-0
F	0.5	+/-0.1

Specifications	
Capacitance:	1500 pF
Voltage:	400 VAC (X)
Voltage:	250 VAC (Y)
Tolerance:	+/-20%
Temperature Range:	-40/+125C
Failure Rate:	N/A
Dissipation Factor:	5%
Insulation Resistance:	10 GOhm
Dielectric Strength:	2600 V

Packaging Specifications	
Package Kind:	Ammo
Package Quantity:	1000