

CDBV3-00340S/C/A-G

Reverse Voltage: 40 Volts

Forward Current: 30 mA

RoHS Device

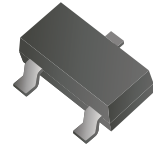

Features

- Design for mounting on small surface.
- High speed switching application, circuit protection.
- Low turn-on voltage.

Mechanical data

- Case: SOT-323, molded plastic.
- Terminals: solderable per MIL-STD-750, method 2026.
- Approx. weight: 0.006 grams

Circuit diagram

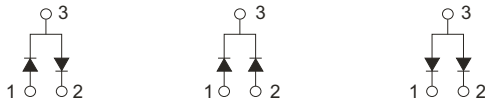

CDBV3-00340S-G

CDBV3-00340C-G

CDBV3-00340A-G

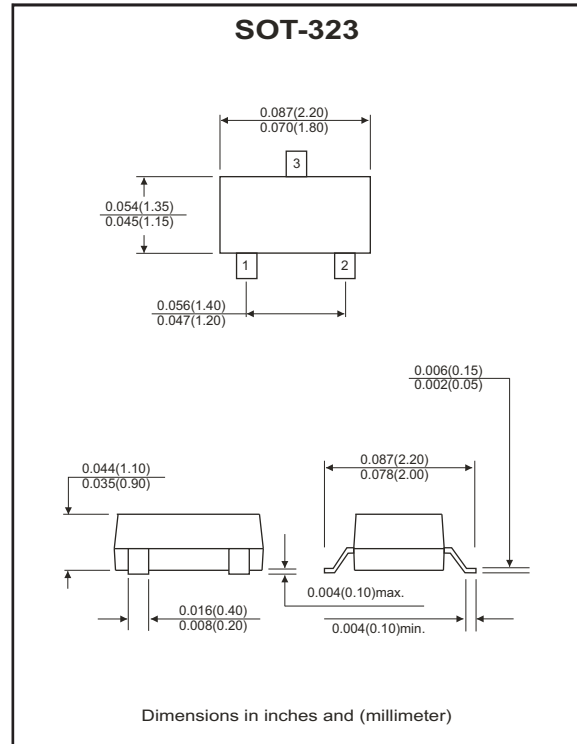

Maximum Ratings (at Ta=25°C unless otherwise noted)

Parameter	Symbol	Conditions	Min.	Typ.	Max.	Units
Repetitive peak reverse voltage	V_{RRM}				40	V
Reverse voltage	V_R				40	V
Average forward current	I_o				30	mA
Peak surge forward current	I_{FSM}	8.3ms half sine-wave superimposed on rate load (JEDEC method)		200		mA
Power dissipation	P_D				200	mW
Storage temperature	T_{STG}				+125	°C
Junction Temperature	T_J				+125	°C

Electrical Characteristics (at Ta=25°C unless otherwise noted)

Parameter	Symbol	Conditions	Min.	Typ.	Max.	Units
Forward voltage	V_F	$I_F=1mA$			0.37	V
Reverse current	I_R	$V_R=10V$			1	μA
Capacitance between terminals	C_T	$f=1MHz, V_R=1V$		2	5	pF

RATING AND CHARACTERISTIC CURVES (CDBV3-00340S/C/A-G)

Fig.1 Forward Characteristics

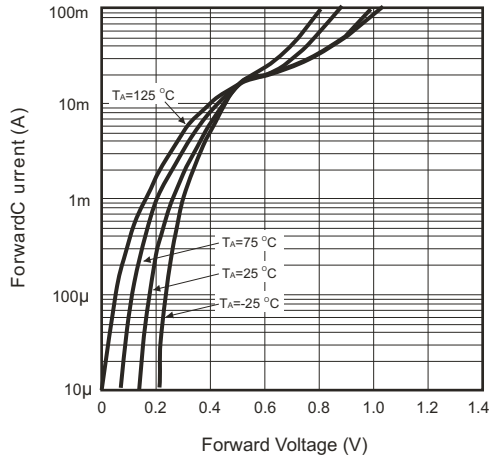

Fig.2 Reverse Characteristics

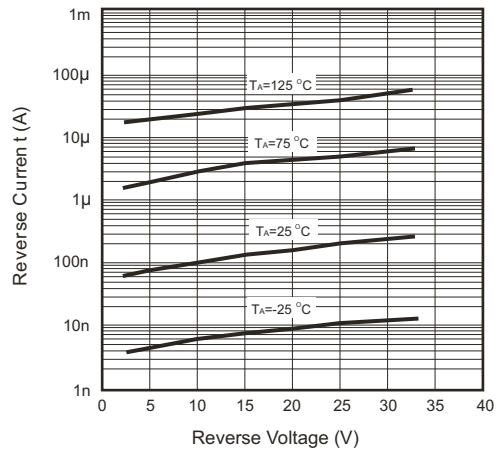

Fig.3 Capacitance Between Terminals Characteristics

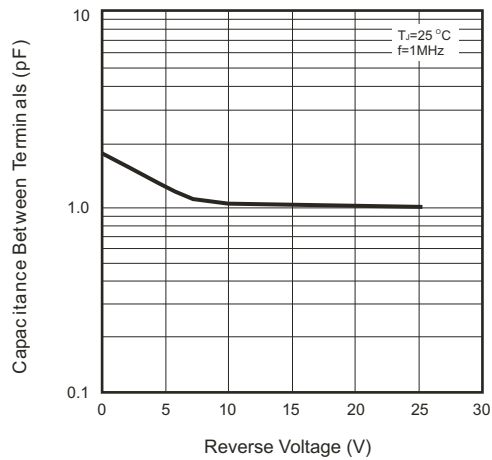
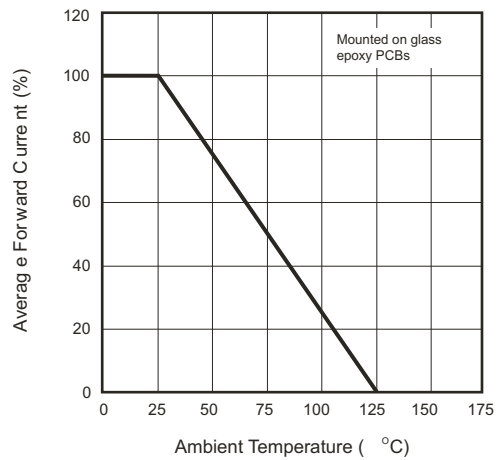

Fig.4 Power Derating Curve



Mouser Electronics

Authorized Distributor

Click to View Pricing, Inventory, Delivery & Lifecycle Information:

[Comchip Technology:](#)

[CDBV3-00340C-G](#)