

**Ordering number C12476_MIRELLA-50-S**

Family	Mirella	FWHM	16 degrees
Type	Reflector	Efficiency	93 %
LED	CXA15	cd/lm	5.100
Color	Metal	Gerber File	Available
Diameter	49.9 mm		
Height	24 mm		
Style	Round		
Optic Material	PC		
Holder Material	-		
Fastening	-		
Status	Ready		

**Ordering number CN12483_MIRELLA-50-S-DL**

Family	Mirella	FWHM	20 degrees
Type	Pack	Efficiency	90 %
LED	CXA15	cd/lm	3.100
Color	Metal	Gerber File	Available
Diameter	49.9 mm		
Height	23.9 mm		
Style	Round		
Optic Material	PC		
Holder Material	-		
Fastening	Glue		
Status	Ready		

**Ordering number C12477_MIRELLA-50-M**

Family	Mirella	FWHM	28 degrees
Type	Reflector	Efficiency	92 %
LED	CXA15	cd/lm	2.500
Color	Metal	Gerber File	Available
Diameter	49.9 mm		
Height	23.9 mm		
Style	Round		
Optic Material	PC		
Holder Material	-		
Fastening	Glue		
Status	Ready		

**Ordering number CN12484_MIRELLA-50-M-DL**

Family	Mirella	FWHM	34 degrees
Type	Pack	Efficiency	89 %
LED	CXA15	cd/lm	1.700
Color	Metal	Gerber File	Available
Diameter	49.9 mm		
Height	23.9 mm		
Style	Round		
Optic Material	PC		
Holder Material	-		
Fastening	Glue		
Status	Ready		

**Ordering number C12478_MIRELLA-50-W**

Family	Mirella	FWHM	42 degrees
Type	Reflector	Efficiency	91 %
LED	CXA15	cd/lm	1.400
Color	Metal	Gerber File	Available
Diameter	49.9 mm		
Height	23.9 mm		
Style	Round		
Optic Material	PC		
Holder Material	-		
Fastening	-		
Status	Ready		

Ordering number CN12485_MIRELLA-50-W-DL

Family	Mirella	FWHM	50 degrees
Type	Pack	Efficiency	87 %
LED	CXA15	cd/lm	1.100
Color	Metal	Gerber File	Available
Diameter	49.9 mm		
Height	23.9 mm		
Style	Round		
Optic Material	PC		
Holder Material	-		
Fastening	Glue		
Status	Ready		

NOTE: The typical divergence will be changed by different color, chip size and chip position tolerance. The typical total divergence is the full angle measured where the luminous intensity is half of the peak value.



PRODUCT DATASHEET

Mirella series

last update 29/4/2013

GENERAL INFORMATION

- Product series especially designed & optimized for CXA15 series of LEDs.
- Special care taken to make light distribution as uniform as possible.
- Lens material optical grade PC with high UV and temperature resistance (120 degrees of Celcius / 248 degrees of Fahrenheit). Allows use of high current and temperature conditions.

Please find more information about used materials from below:

http://ledil.fi/sites/default/files/Documents/Technical/Material/PC%20Makrolon%202400_2407_2456_2458-UL.pdf

- Reflector is made of aluminium coated PC (120 degrees of Celcius / 248 degrees of Fahrenheit) with protective lacquer (110 degrees of Celcius / 230 degrees of Fahrenheit).

- Fastening to PCB with appropriate adhesive. By clicking link below you can find Ledil recommended glue options.

http://www.ledil.com/datasheets/DataSheet_GLUES.pdf

NOTE 1: We advise customer to ensure the suitability and sufficiency of the bond in the end product. For example, mechanical stress, vibration and holes on the surface of the circuit board weaken the strength of the glue.

NOTE 2: All surfaces where glue is applied must be clean, dry and free from grease and dirt. If cleaning of PCB surfaces is needed, please follow strictly the cleaning instructions of your LED manufacturer -this is important as cleaning shall under no circumstances damage LEDs or other electronics components on the PCB.

Further note that optical components shall not be cleaned with any chemicals - only micro fiber cloth may be used to remove fingerprints or other traces from handling.

Relative intensity of C12476_MIRELLA-50-S

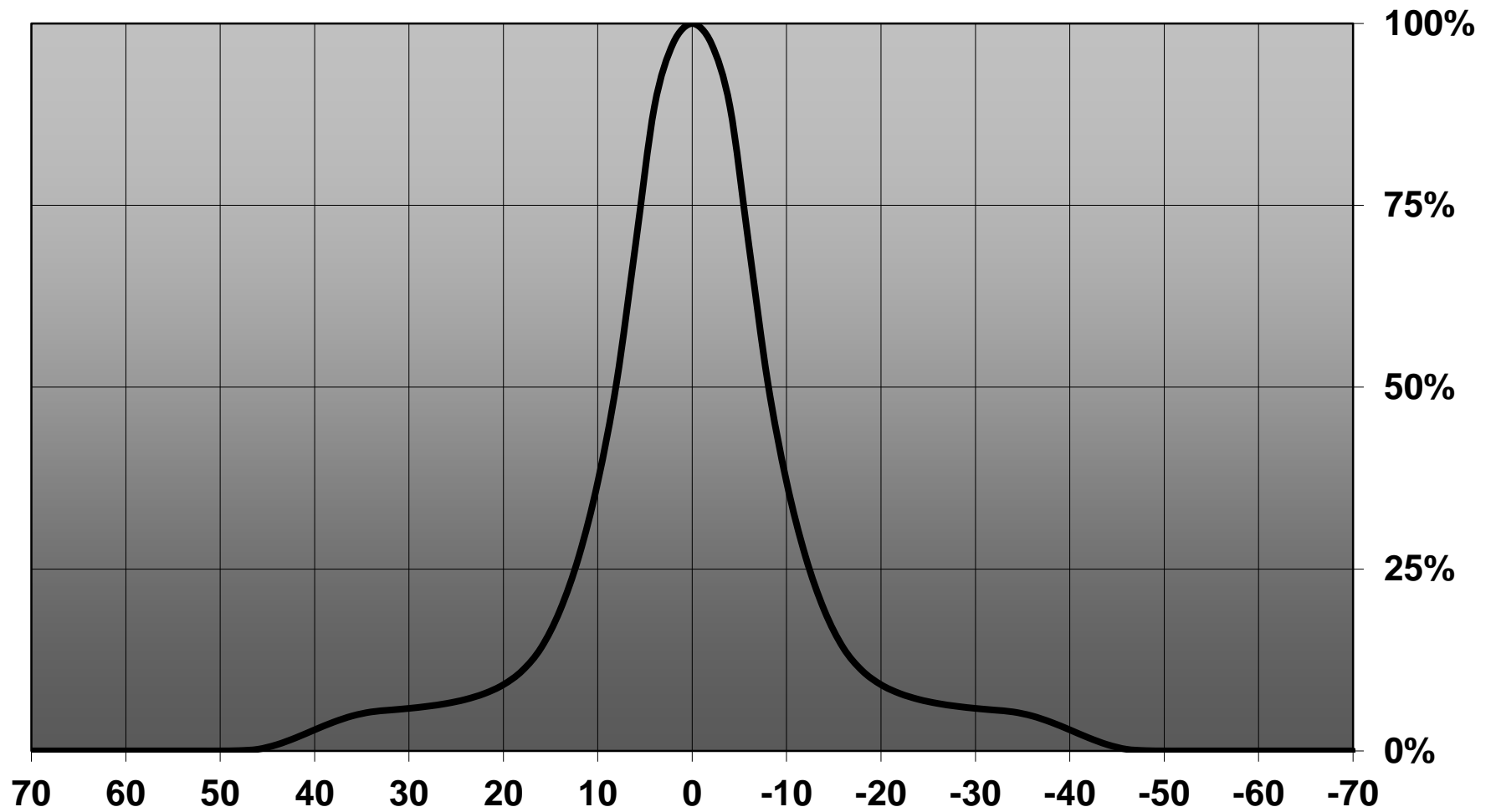

Relative intensity of CN12483_MIRELLA-50-S-DL

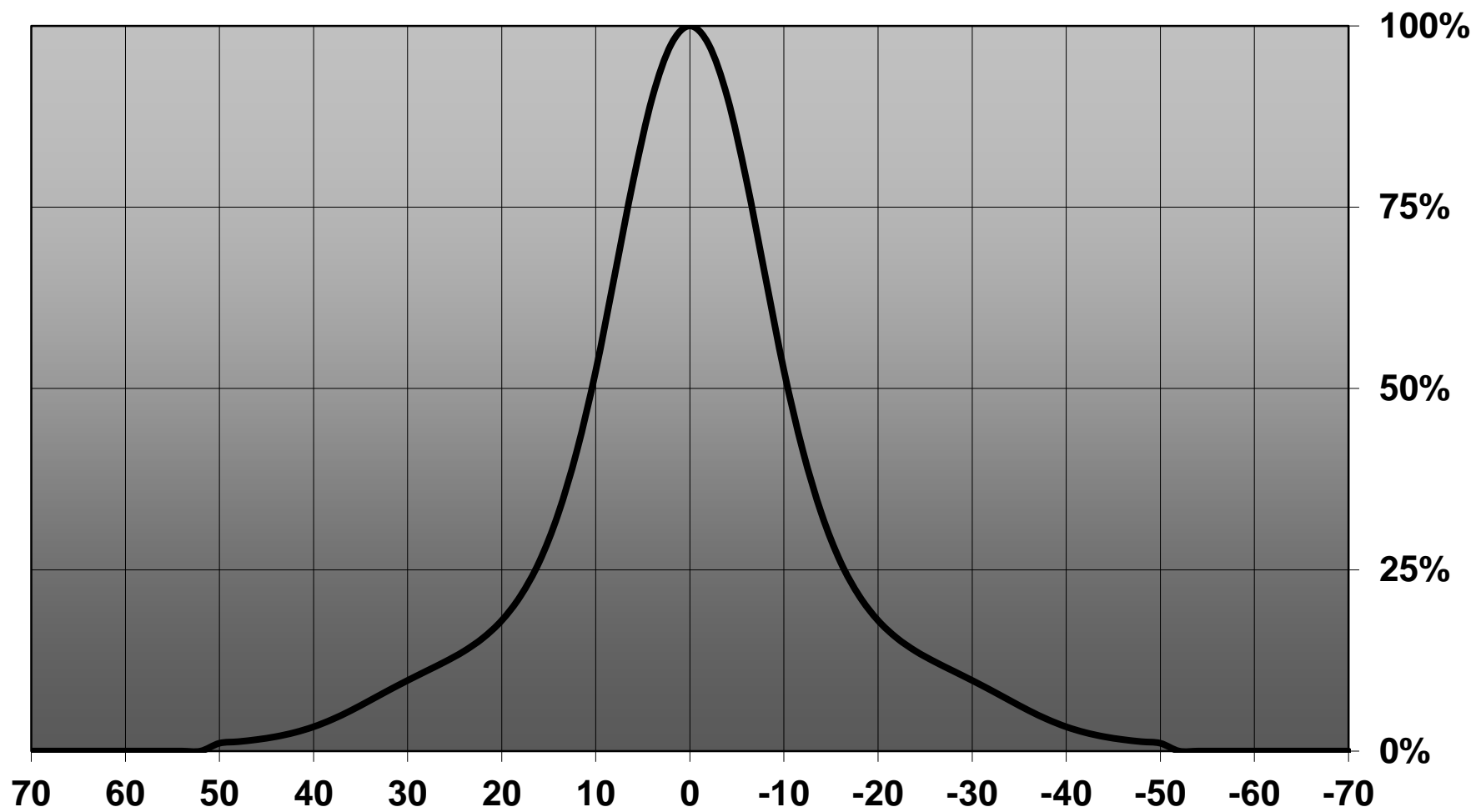

Relative intensity of C12477_MIRELLA-50-M

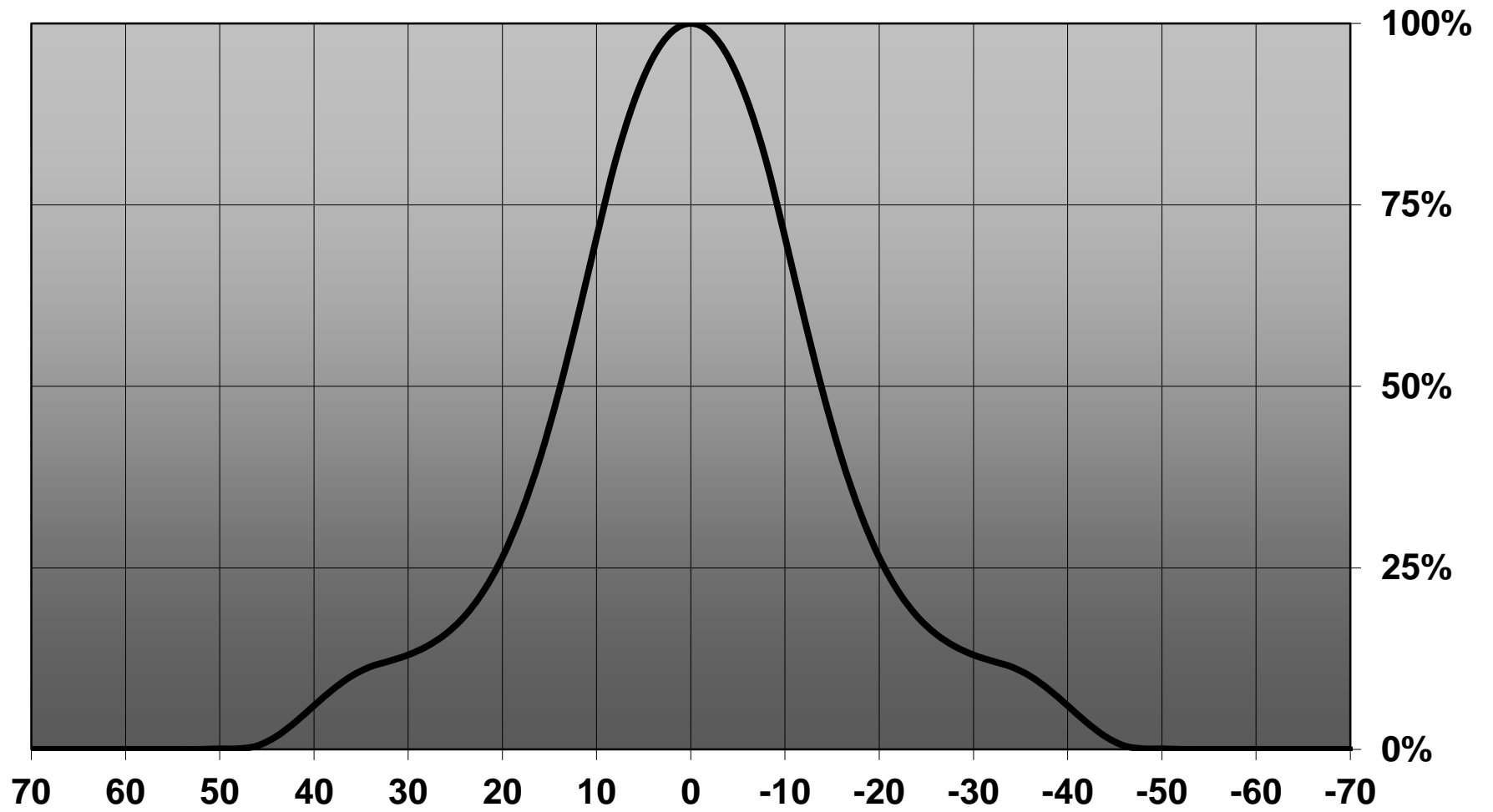

Relative intensity of CN12484_MIRELLA-50-M-DL

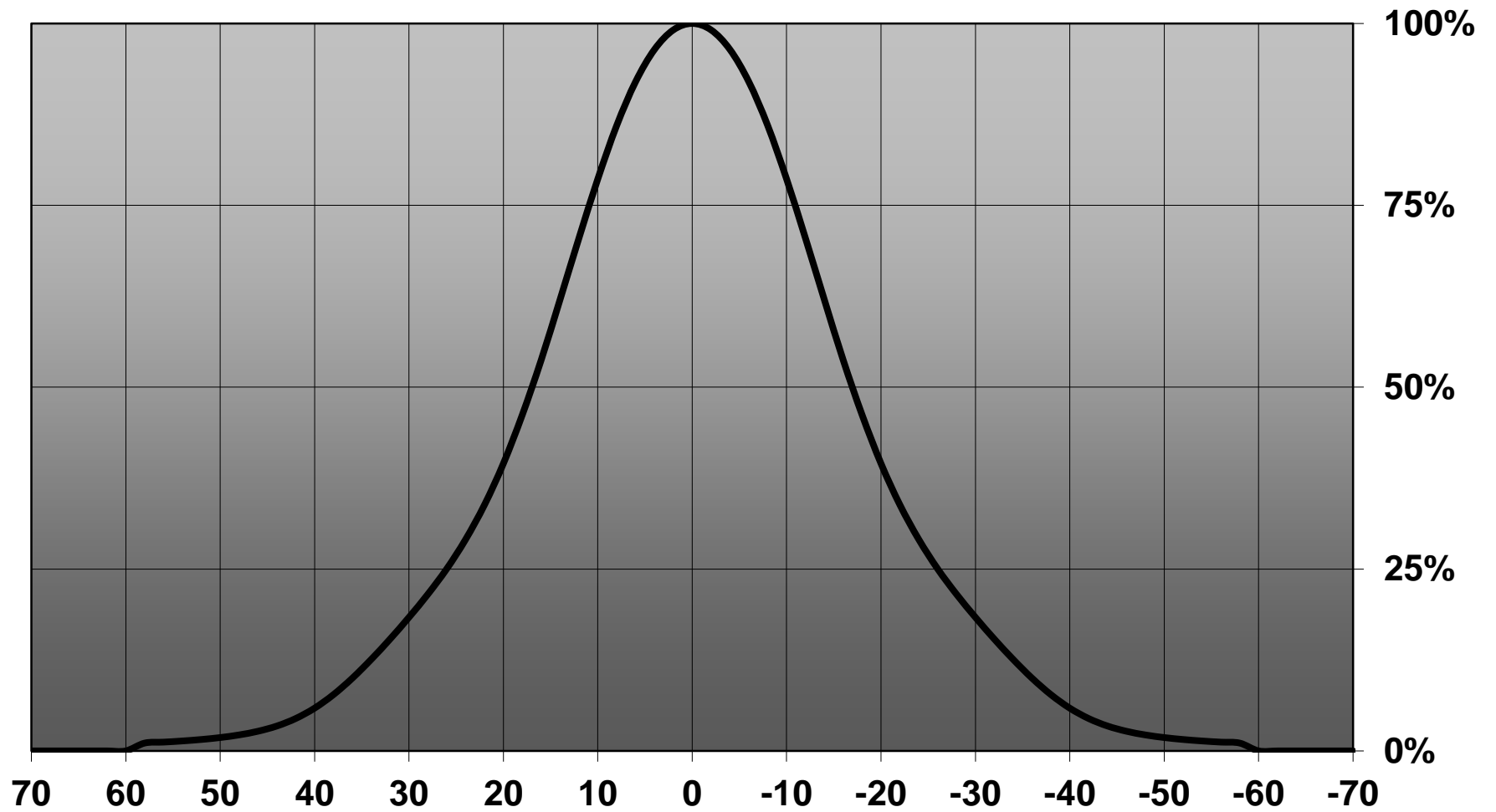

Relative intensity of C12478_MIRELLA-50-W

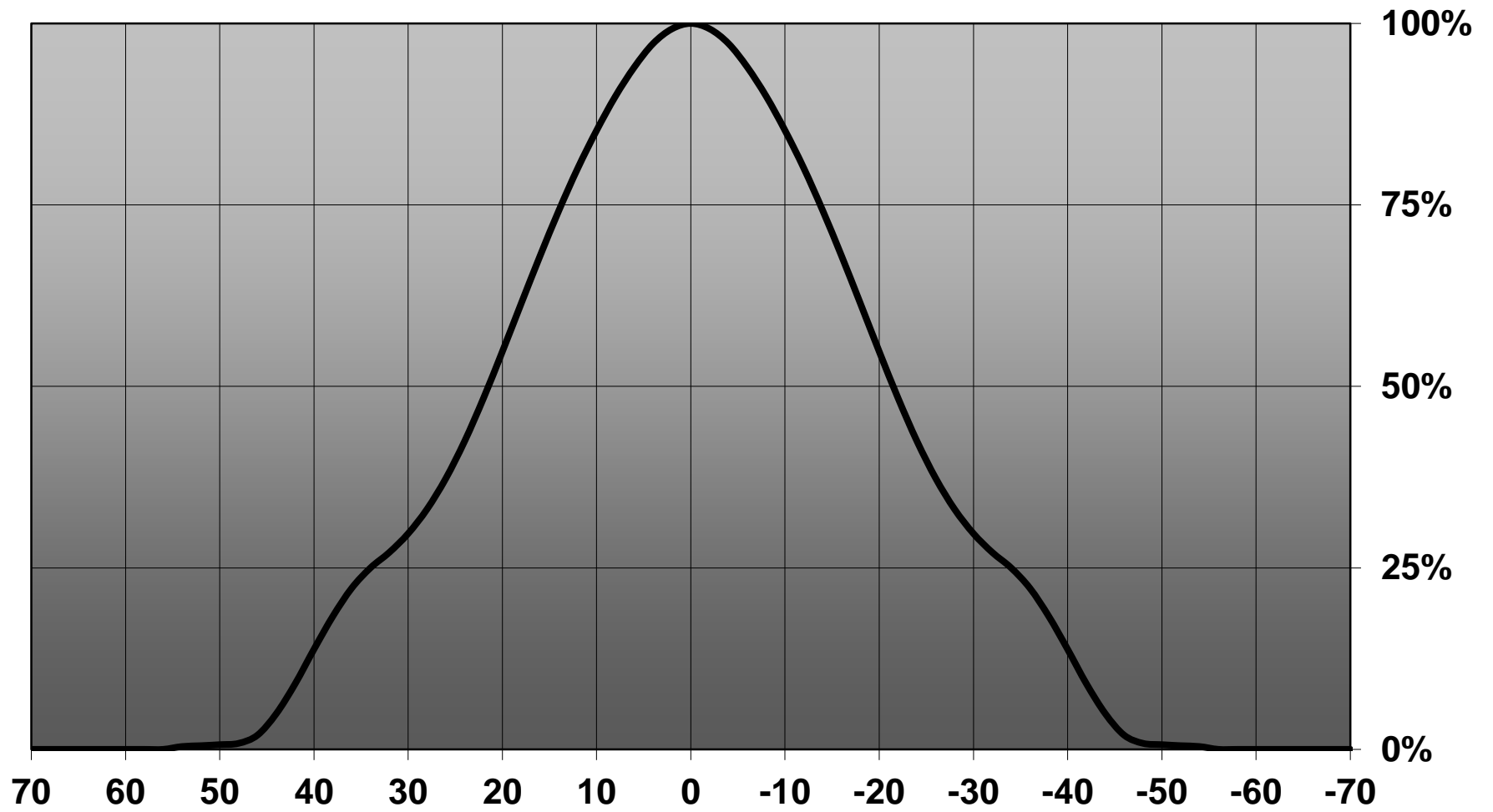

Relative intensity of CN12485_MIRELLA-50-W-DL

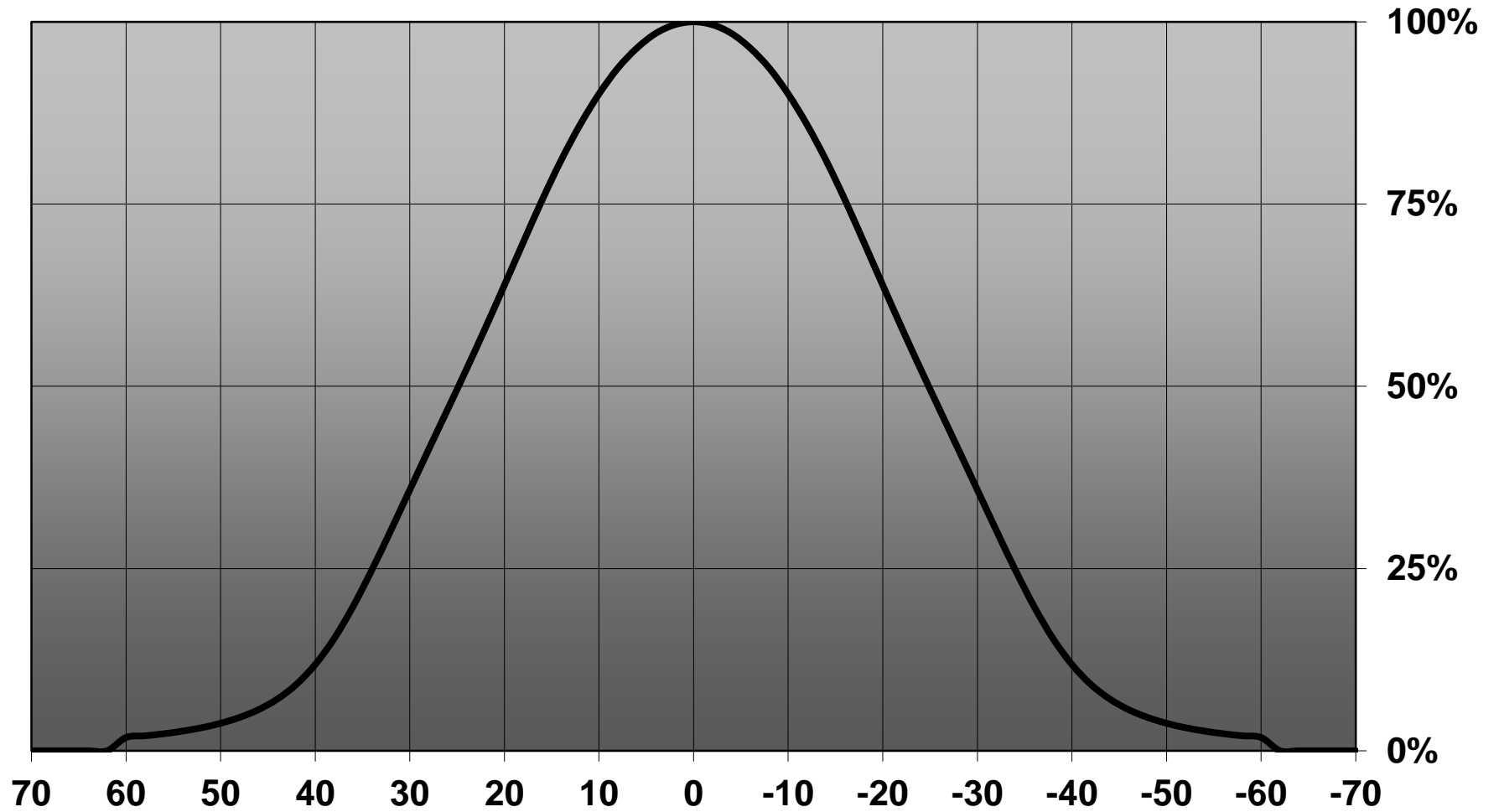

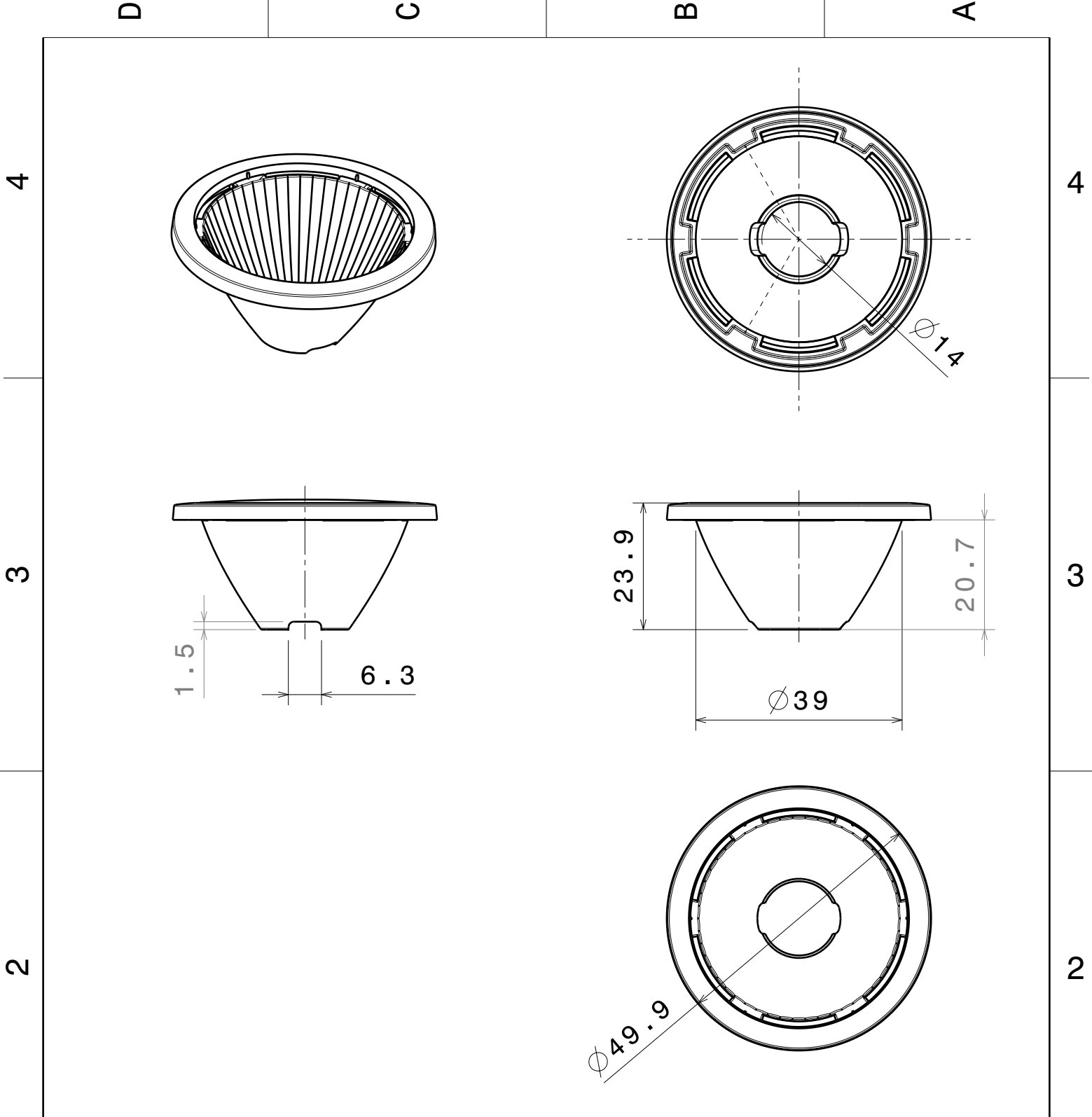

Material: PC, metal plated

This drawing is our property.
It can't be reproduced
or communicated without
our written agreement.



Ledil Oy
Salorankatu 10
FIN-24240 SALO
Finland

DRAWING TITLE

Datasheet Mirella reflector

DRAWN BY pl		DATE 25.11.2011		DRAWING TITLE Datasheet Mirella reflector		
CHECKED BY		DATE		SIZE A4	DRAWING NUMBER	REV 1
DESIGNED BY pl		DATE 25.11.2011		SCALE 1:1	WEIGHT (g)	SHEET 1/1

D

A

LEDiL Oy C12476_MIRELLA-50-S_(CXA1507) Eff.91.6% / LDC (Linear)

Luminaire: LEDiL Oy C12476_MIRELLA-50-S_(CXA1507) Eff.91.6%
Lamps: 1 x CREE_CXA1507 (CXA1507-30F-F2-N0A-00000) 238.378lm@50mA CCT=3000K P=1.8506W
I=54.5mA

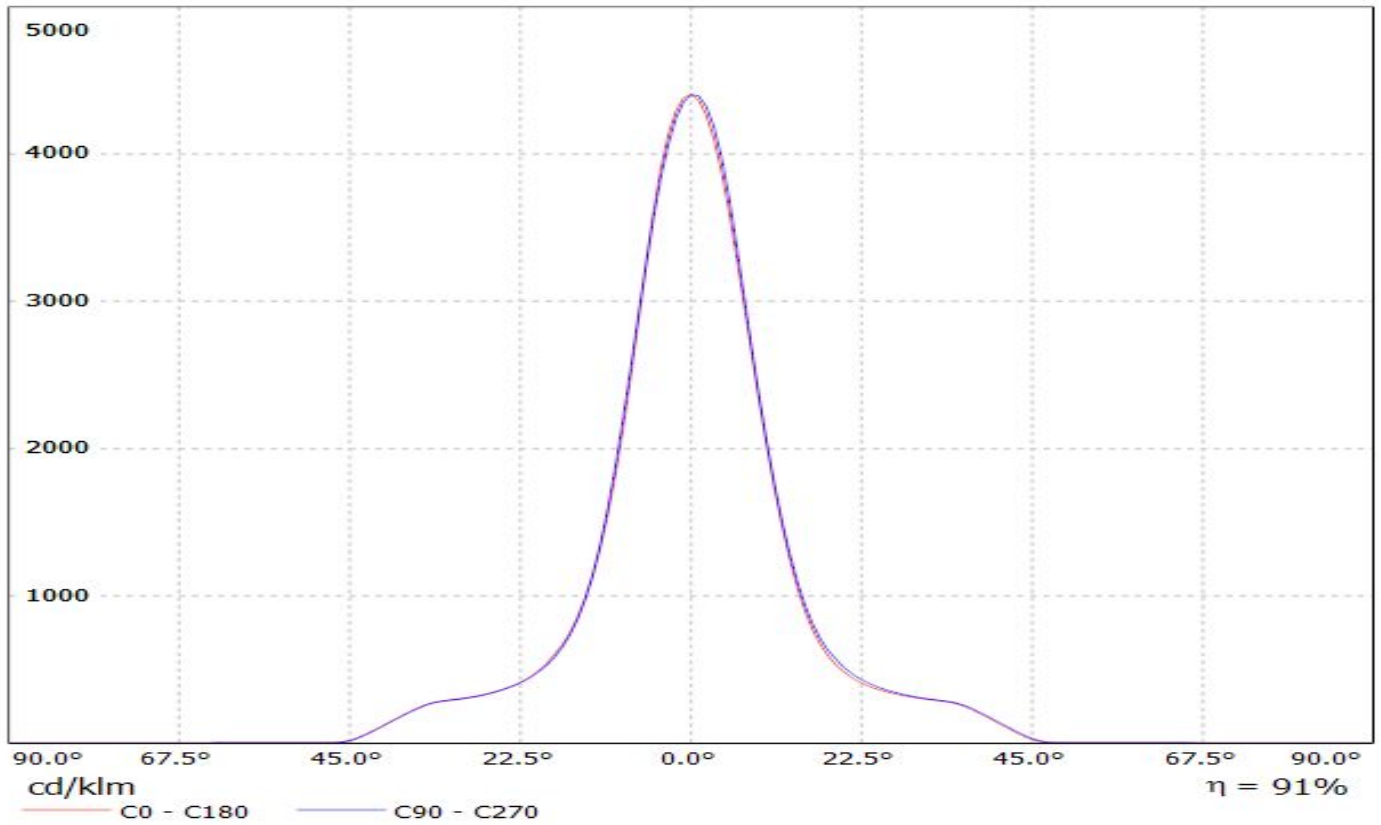

LEDiL Oy CN12483_MIRELLA-50-S-DL_(CXA1507) Eff.86.9% / LDC (Linear)

Luminaire: LEDiL Oy CN12483_MIRELLA-50-S-DL_(CXA1507) Eff.86.9%
Lamps: 1 x CREE_CXA1507 (CXA1507-30F-F2-N0A-00000) 238.378lm@50mA CCT=3000K P=1.8506W I=54.5mA

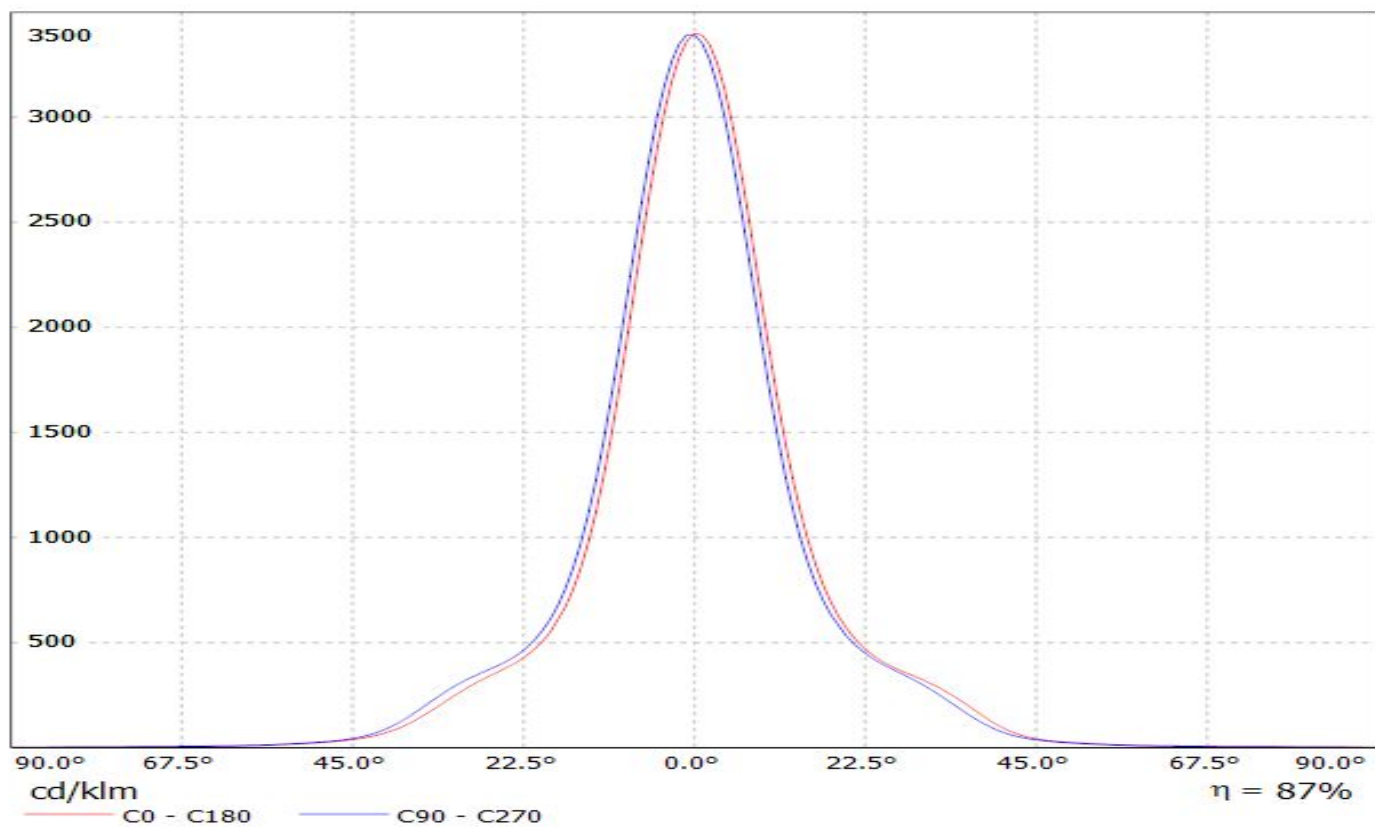

LEDiL Oy C12477_MIRELLA-50-M_(CXA1507) Eff.90.8% / LDC (Linear)

Luminaire: LEDiL Oy C12477_MIRELLA-50-M_(CXA1507) Eff.90.8%

Lamps: 1 x CREE_CXA1507 (CXA1507-30F-F2-N0A-00000) 238.378lm@50mA CCT=3000K P=1.8506W I=54.5mA

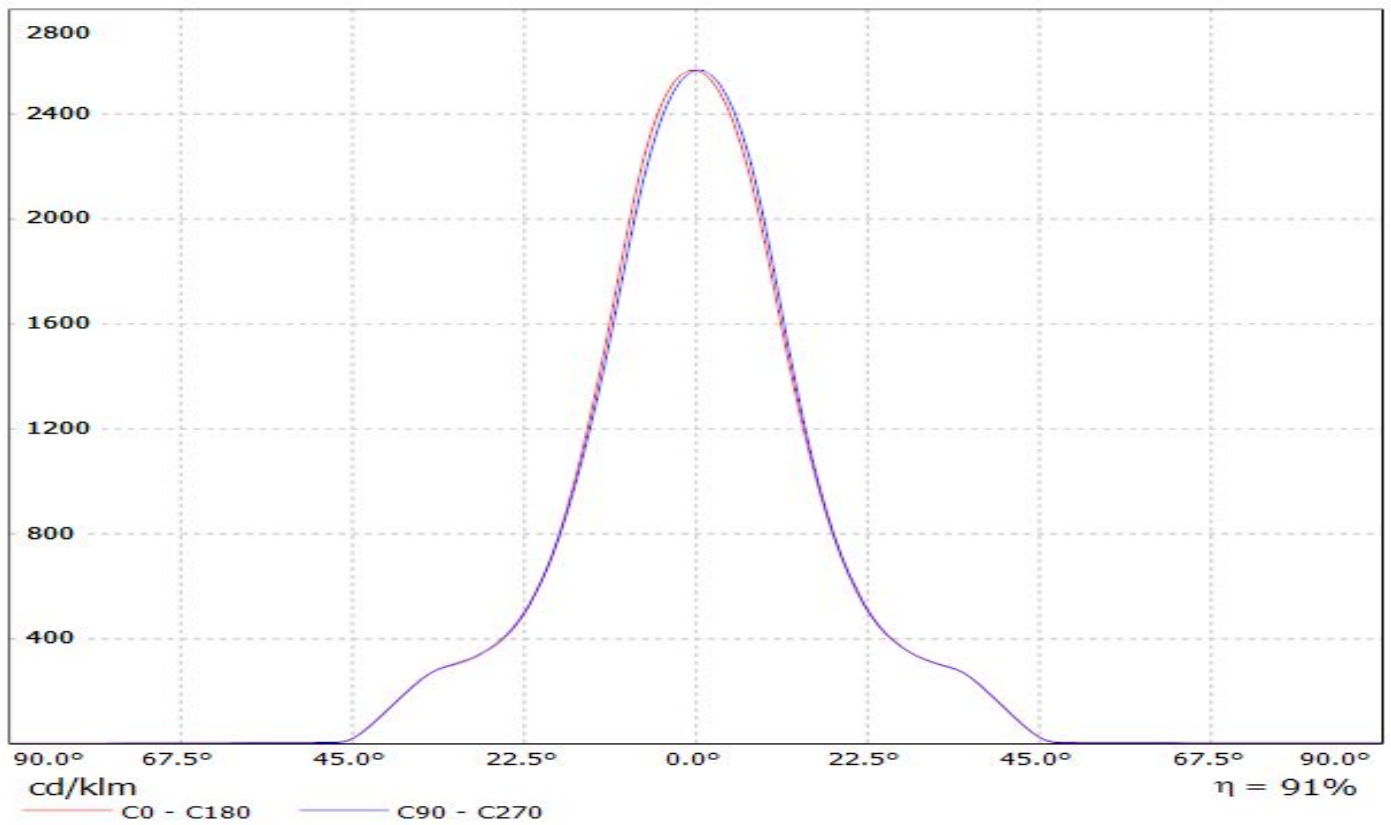

LEDiL Oy CN12484_MIRELLA-50-M-DL_(CXA1507) Eff.86.0% / LDC (Linear)

Luminaire: LEDiL Oy CN12484_MIRELLA-50-M-DL_(CXA1507) Eff.86.0%

Lamps: 1 x CREE_CXA1507 (CXA1507-30F-F2-N0A-00000) 238.378lm@50mA CCT=3000K P=1.8506W I=54.5mA

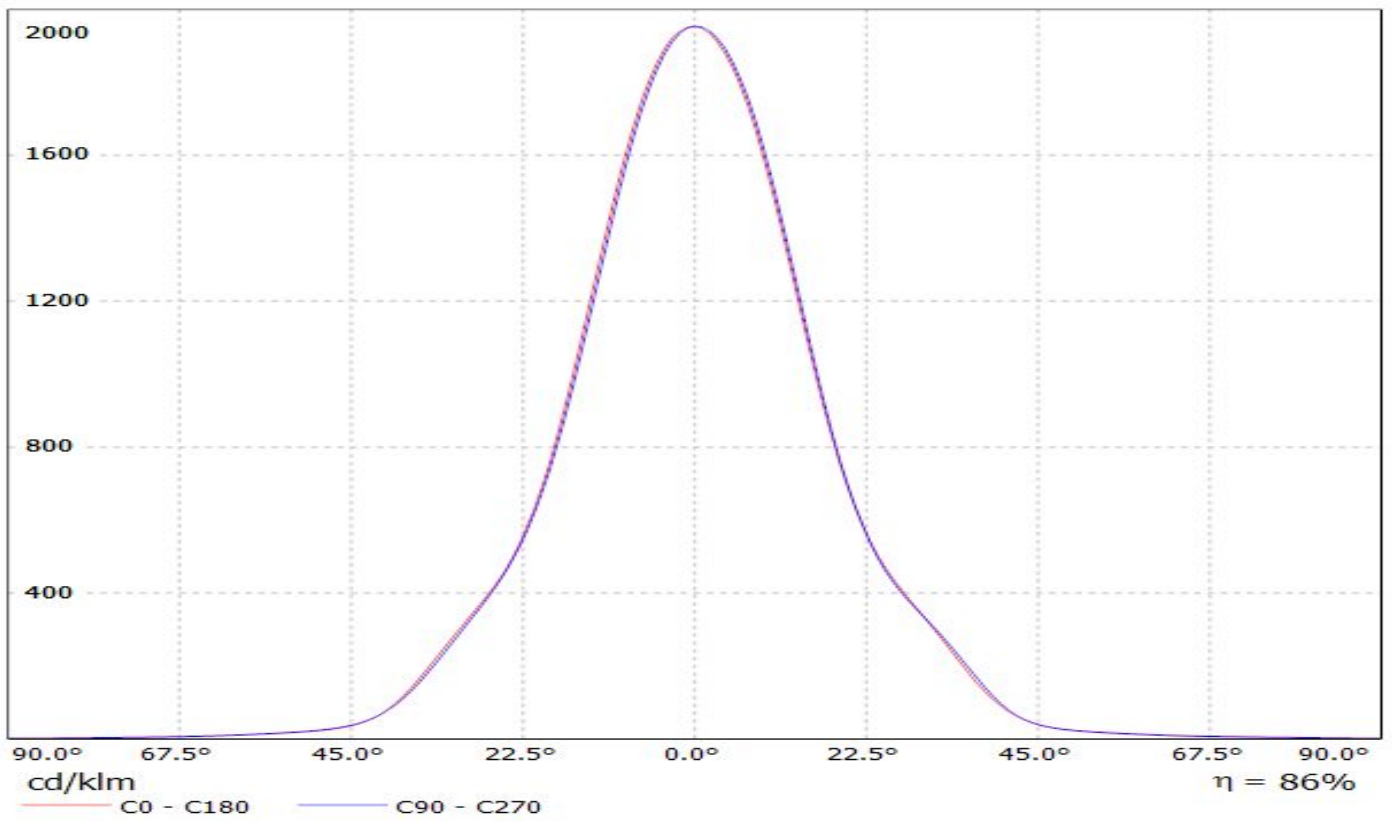

LEDiL Oy C12478_MIRELLA-50-W_(CXA1507) Eff.89.6% / LDC (Linear)

Luminaire: LEDiL Oy C12478_MIRELLA-50-W_(CXA1507) Eff.89.6%
Lamps: 1 x CREE_CXA1507 (CXA1507-30F-F2-N0A-00000) 238.378lm@50mA CCT=3000K P=1.8506W I=54.5mA

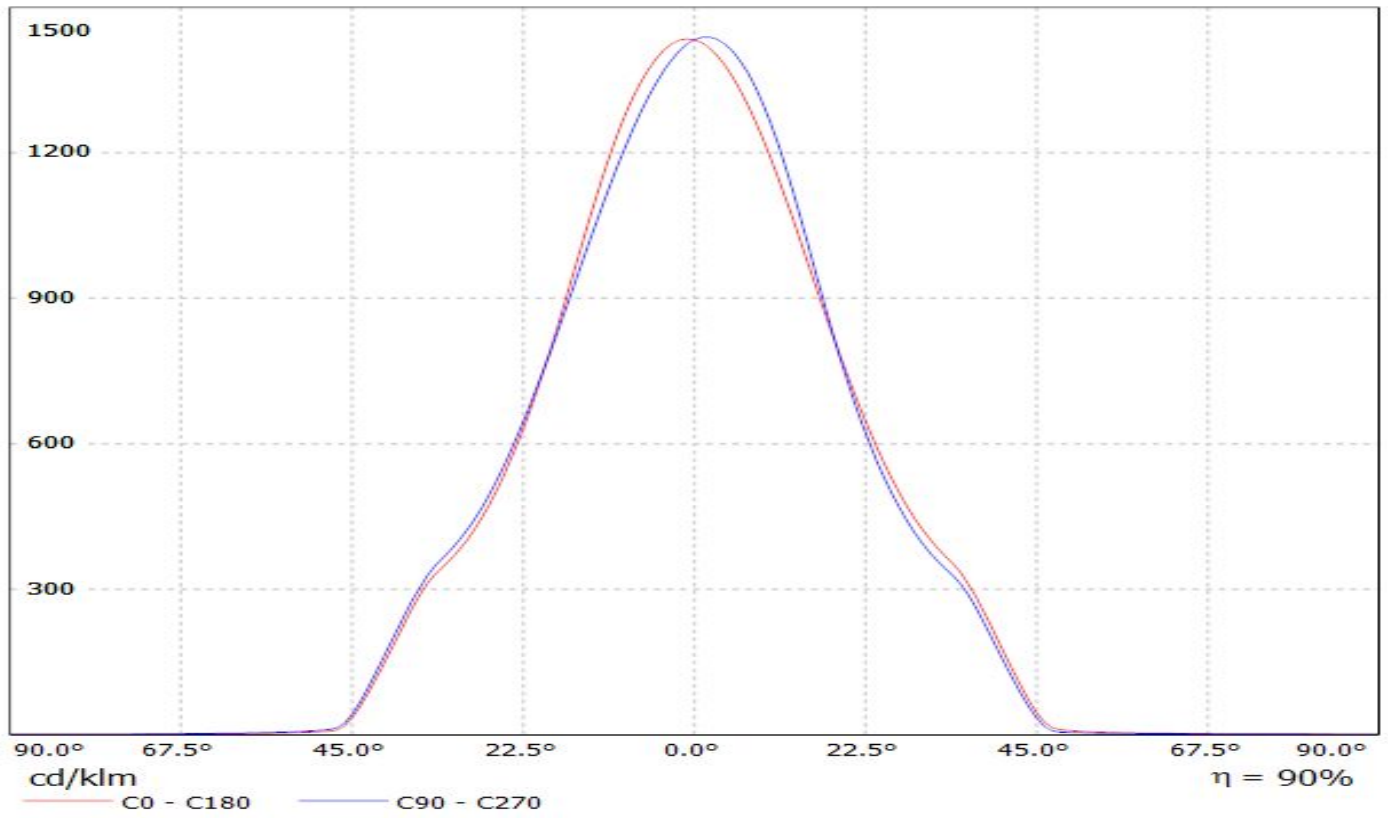

LEDiL Oy CN12485_MIRELLA-50-W-DL_(CXA1507) Eff.84.8% / LDC (Linear)

Luminaire: LEDiL Oy CN12485_MIRELLA-50-W-DL_(CXA1507) Eff.84.8%
Lamps: 1 x CREE_CXA1507 (CXA1507-30F-F2-N0A-00000) 238.378lm@50mA CCT=3000K P=1.8506W I=54.5mA

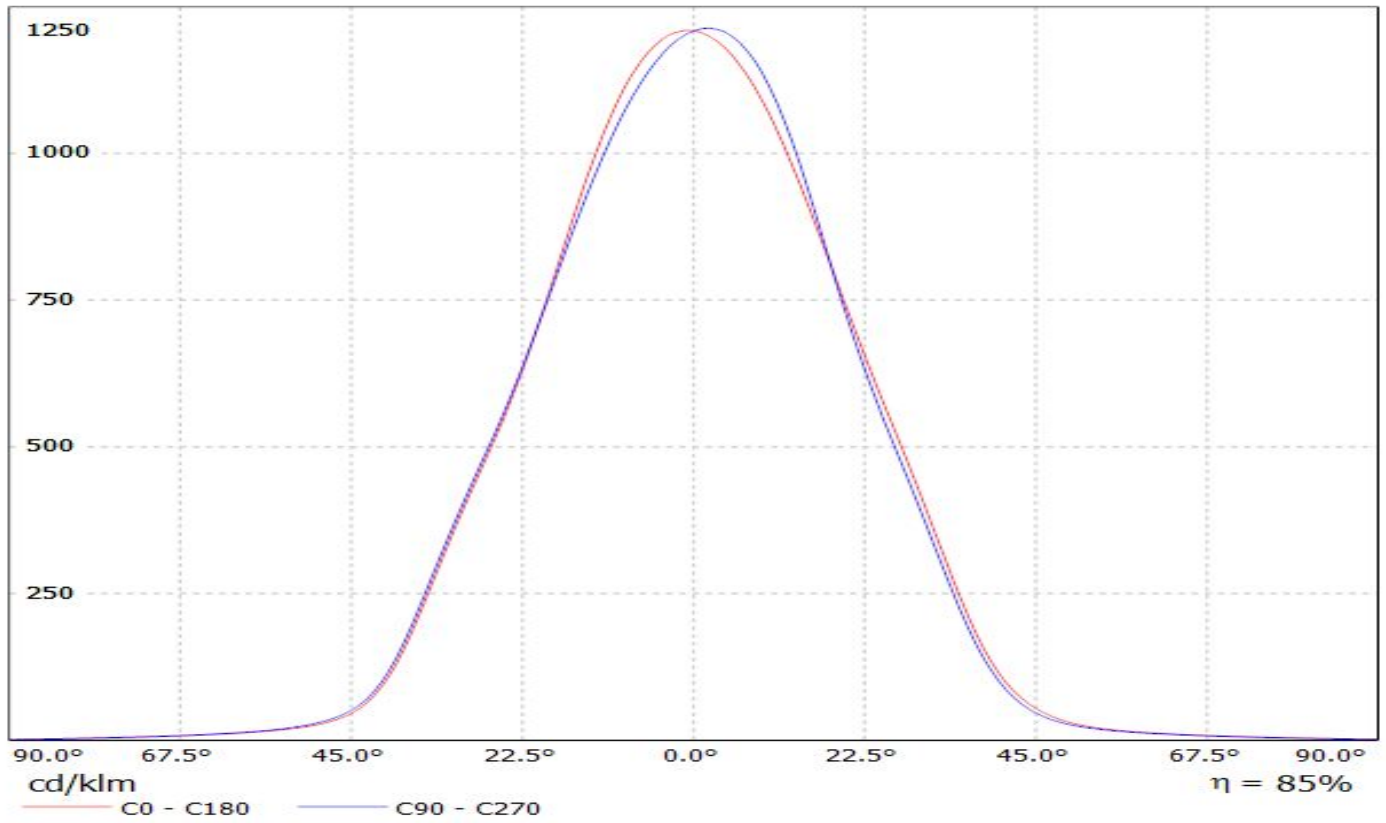

LEDiL Oy C12476_MIRELLA-50-S_(CXA1507) Eff.91.6% / LDC (Polar)

Luminaire: LEDiL Oy C12476_MIRELLA-50-S_(CXA1507) Eff.91.6%

Lamps: 1 x CREE_CXA1507 (CXA1507-30F-F2-N0A-00000) 238.378lm@50mA CCT=3000K P=1.8506W I=54.5mA

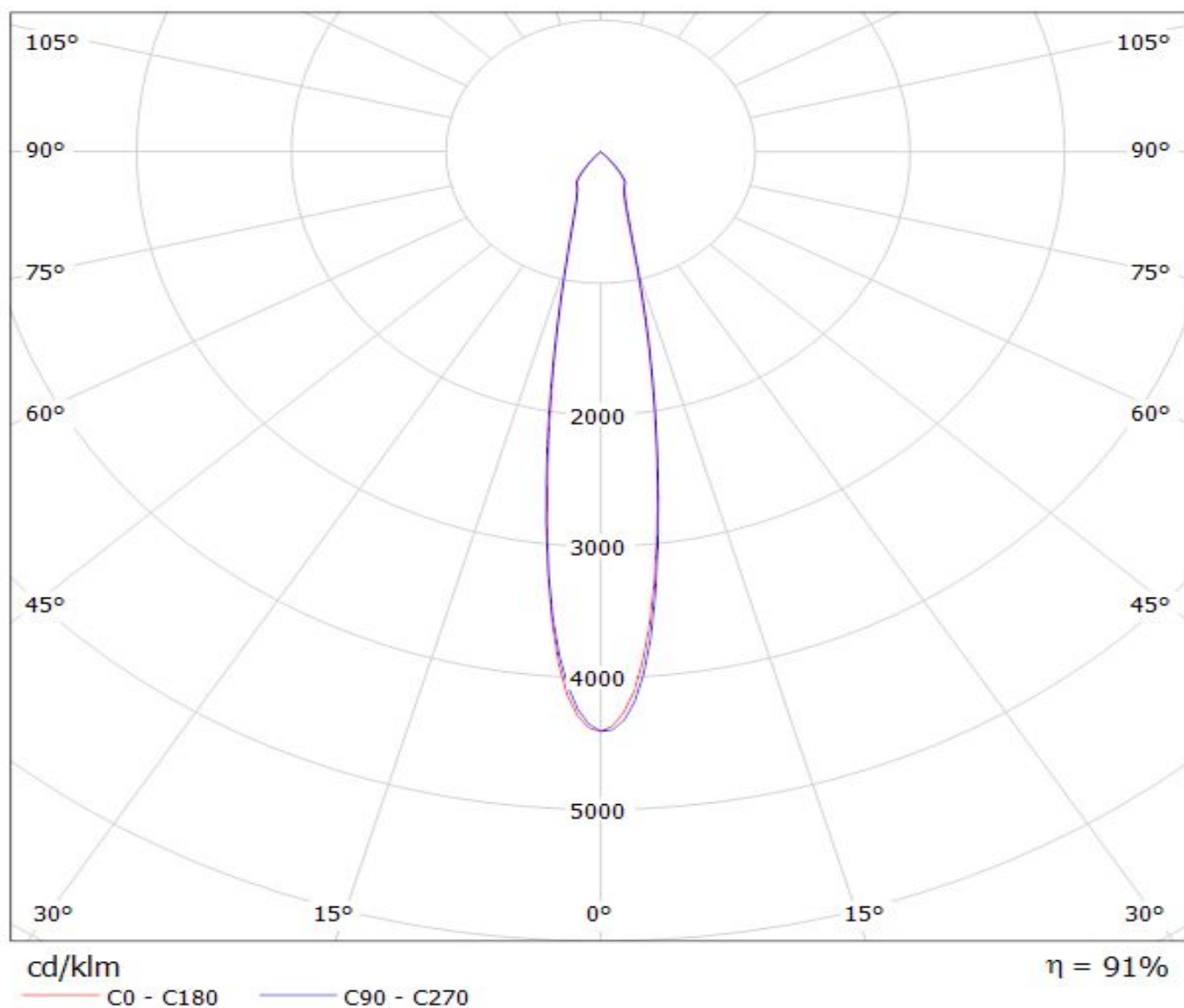

LEDiL Oy CN12483_MIRELLA-50-S-DL_(CXA1507) Eff.86.9% / LDC (Polar)

Luminaire: LEDiL Oy CN12483_MIRELLA-50-S-DL_(CXA1507) Eff.86.9%

Lamps: 1 x CREE_CXA1507 (CXA1507-30F-F2-N0A-00000) 238.378lm@50mA CCT=3000K P=1.8506W I=54.5mA

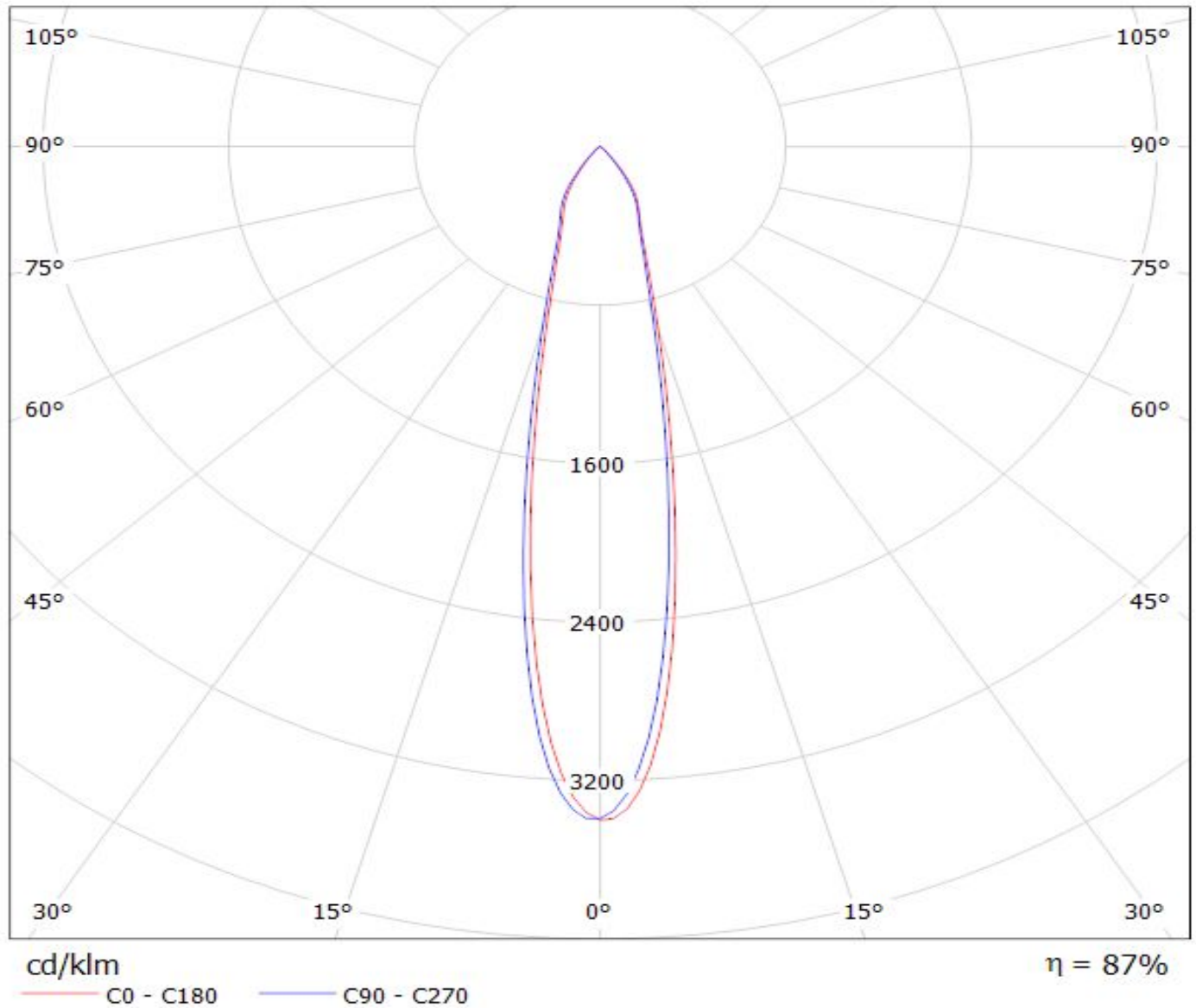

LEDiL Oy C12477_MIRELLA-50-M_(CXA1507) Eff.90.8% / LDC (Polar)

Luminaire: LEDiL Oy C12477_MIRELLA-50-M_(CXA1507) Eff.90.8%

Lamps: 1 x CREE_CXA1507 (CXA1507-30F-F2-N0A-00000) 238.378lm@50mA CCT=3000K P=1.8506W I=54.5mA

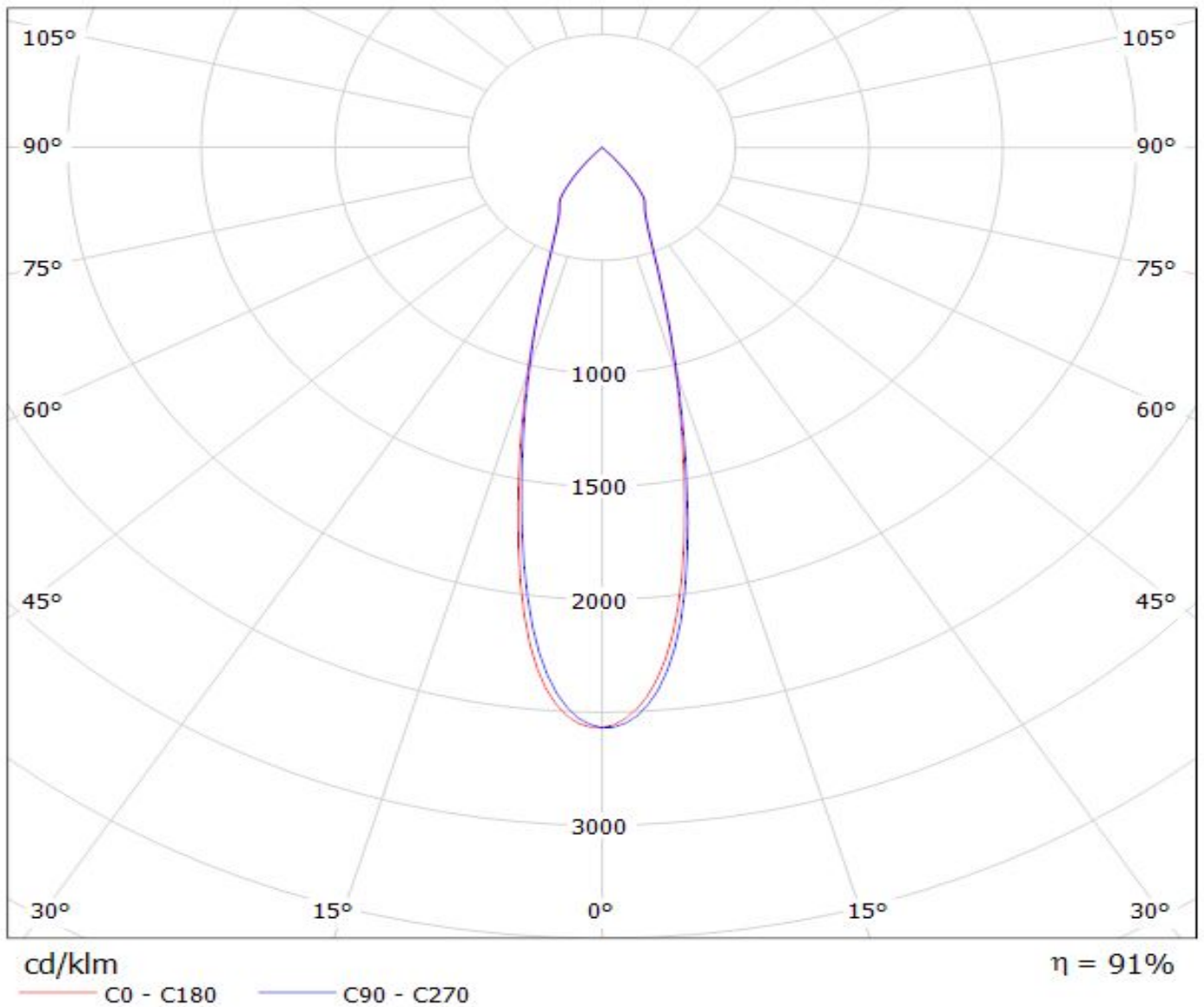

LEDiL Oy CN12484_MIRELLA-50-M-DL_(CXA1507) Eff.86.0% / LDC (Polar)

Luminaire: LEDiL Oy CN12484_MIRELLA-50-M-DL_(CXA1507) Eff.86.0%

Lamps: 1 x CREE_CXA1507 (CXA1507-30F-F2-N0A-00000) 238.378lm@50mA CCT=3000K P=1.8506W I=54.5mA

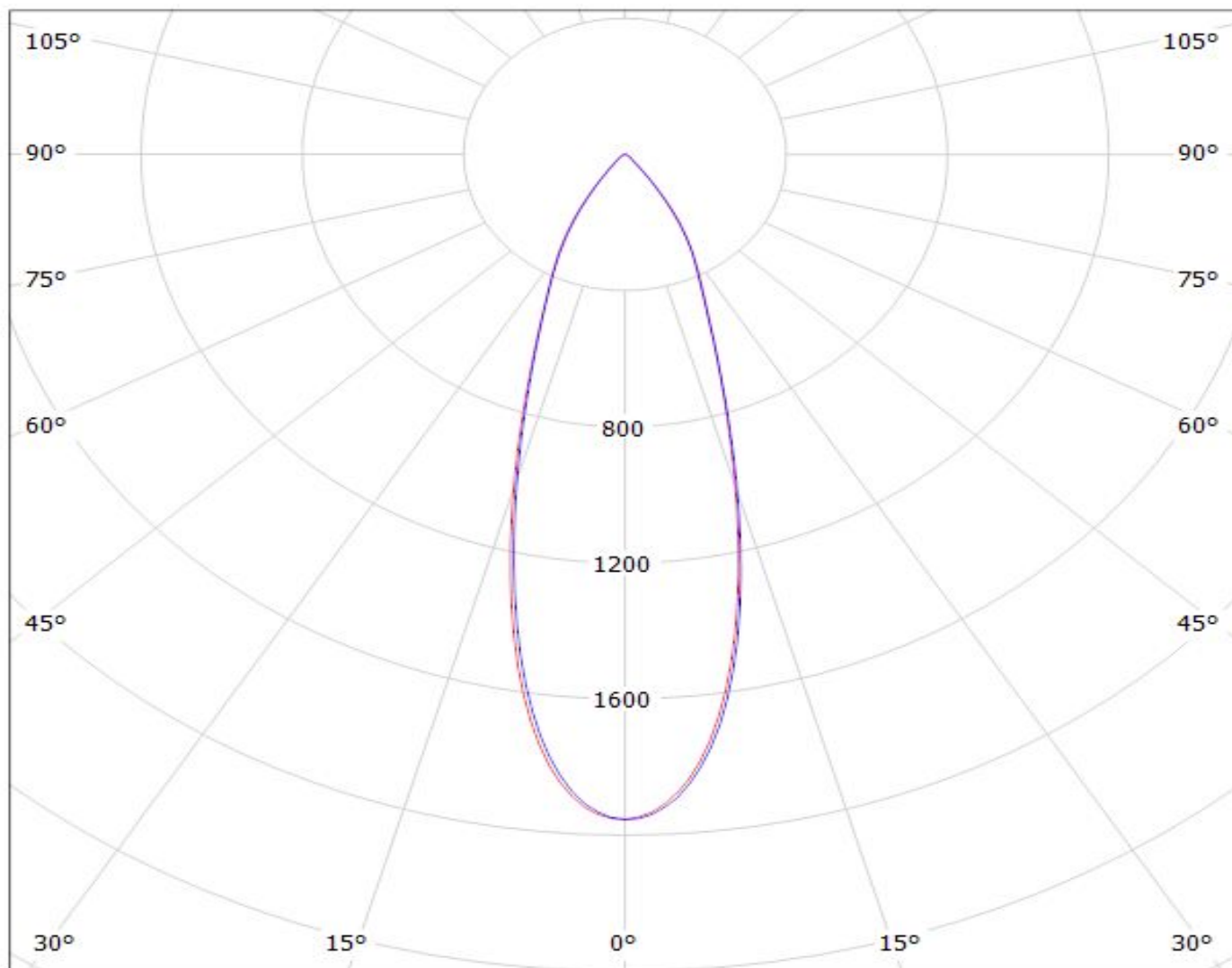

cd/klm

— C0 - C180 — C90 - C270

$\eta = 86\%$

LEDiL Oy C12478_MIRELLA-50-W_(CXA1507) Eff.89.6% / LDC (Polar)

Luminaire: LEDiL Oy C12478_MIRELLA-50-W_(CXA1507) Eff.89.6%

Lamps: 1 x CREE_CXA1507 (CXA1507-30F-F2-N0A-00000) 238.378lm@50mA CCT=3000K P=1.8506W I=54.5mA

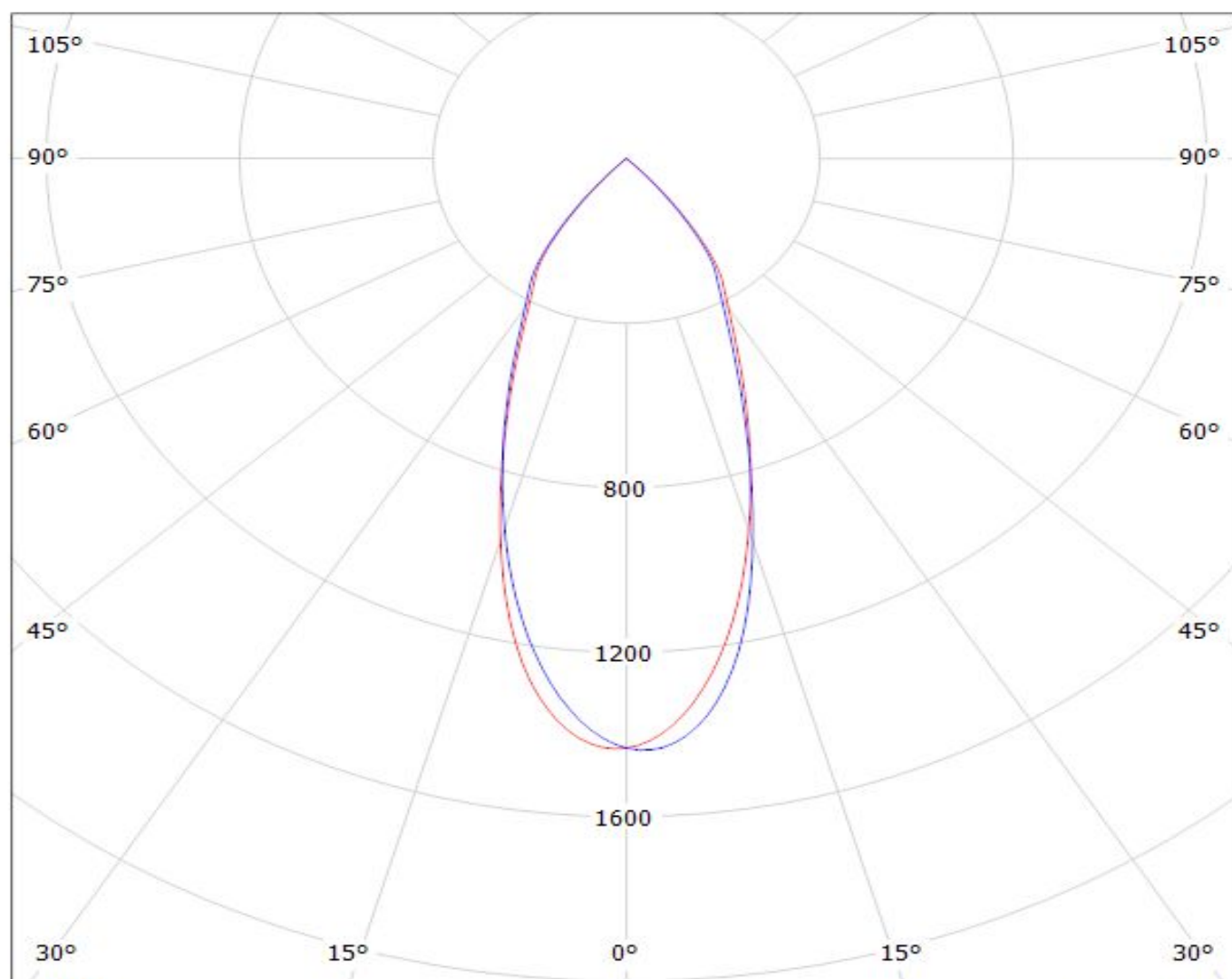

cd/klm

— C0 - C180

— C90 - C270

$\eta = 90\%$

LEDiL Oy CN12485_MIRELLA-50-W-DL_(CXA1507) Eff.84.8% / LDC (Polar)

Luminaire: LEDiL Oy CN12485_MIRELLA-50-W-DL_(CXA1507) Eff.84.8%

Lamps: 1 x CREE_CXA1507 (CXA1507-30F-F2-N0A-00000) 238.378lm@50mA CCT=3000K P=1.8506W I=54.5mA

