

# Cree® PLCC4 3-in-1 SMD LED CLVBA-FKA



## PRODUCT DESCRIPTION

These SMD LEDs are packaged in an industry standard PLCC4 package. These high reliability and high brightness LEDs are designed to work in a wide range of environmental conditions. A wide viewing angle and high brightness makes these LEDs suitable for indoor signage applications.

## FEATURES

- Size (mm): 3.2 x 2.8
- Dominant Wavelength:  
Red (619 - 624nm)  
Green (520 - 540nm)  
Blue (460 - 480nm)
- Luminous Intensity (mcd)  
@IF=20mA  
Red (224 - 560)  
Green (280 - 900)  
Blue (90 - 355)
- Lead-Free
- RoHS Compliant

## APPLICATIONS

- Full-Color Video Screen
- Decorative lighting
- Amusement

### ABSOLUTE MAXIMUM RATINGS ( $T_A = 25^\circ\text{C}$ )

Items	Symbol	Absolute Maximum Rating			Unit
		R	G	B	
Forward Current <sup>Note 1</sup>	$I_F$	50	25	25	mA
Peak Forward Current <sup>Note 2</sup>	$I_{FP}$	200	100	100	mA
Reverse Voltage	$V_R$	5	5	5	V
Power Dissipation	$P_D$	130	100	100	mW
Operation Temperature	$T_{opr}$	-40 ~ +100			$^\circ\text{C}$
Storage Temperature	$T_{stg}$	-40 ~ +100			$^\circ\text{C}$
Junction Temperature	$T_J$	110	110	110	$^\circ\text{C}$
Junction/ambient 1 chip on	$R_{THJA}$	450	400	450	$^\circ\text{C}/\text{W}$
Junction/ambient 3 chips on	$R_{THJA}$	650	580	680	$^\circ\text{C}/\text{W}$
Junction/solder point 1 chip on	$R_{THJS}$	300	280	300	$^\circ\text{C}/\text{W}$
Junction/solder point 3 chips on	$R_{THJS}$	450	430	480	$^\circ\text{C}/\text{W}$

**Note:** 1.Single-color light.  
2.Pulse width  $\leq 0.1$  msec, duty  $\leq 1/10$ .

### TYPICAL ELECTRICAL & OPTICAL CHARACTERISTICS ( $T_A = 25^\circ\text{C}$ )

Characteristics	Condition	Symbol	Values			Unit
			R	G	B	
Dominant Wavelength	$I_F = 20$ mA	$\lambda_{DOM}$	619~624	520~540	460~480	nm
Spectral bandwidth at 50% $I_{REL}$ max	$I_F = 20$ mA	$\Delta \lambda$	24	38	28	nm
Forward Voltage	$I_F = 8$ mA	$V_{F(avg)}$	1.9	3.0	3.0	V
		$V_{F(max)}$	2.4	3.6	3.6	V
Luminous Intensity	$I_F = 20$ mA	$I_{V(min)}$	224	280	90	mcd
		$I_{V(avg)}$	320	500	160	mcd
Luminous Intensity	$I_F = 8$ mA	$I_{V(min)}$	71	140	36	mcd
		$I_{V(avg)}$	112	224	56	mcd
Reverse Current (max)	$V_R = 5$ V	$I_R$	10	10	10	$\mu\text{A}$

## INTENSITY BIN LIMIT ( $I_F = 8 \text{ mA}$ )

### Red

Bin Code	Min.(mcd)	Max.(mcd)
A	71	90
3a4	81	101
B	90	112
56	101	126
C	112	140
78	126	160
D	140	180
9a	160	202
E	180	224

### Green

Bin Code	Min.(mcd)	Max.(mcd)
D	140	180
9a	160	202
E	180	224
bc	202	252
F	224	280
de	252	318
G	280	355
fg	318	403
H	355	450

### Blue

Bin Code	Min.(mcd)	Max.(mcd)
L8	36	45
3g3f	41	51
L9	45	56
3e3d	51	64
L	56	71
3c3b	64	81
A	71	90
3a4	81	101
B	90	112

Tolerance of measurement of luminous intensity is  $\pm 10\%$ .

## COLOR BIN LIMIT ( $I_F = 8 \text{ mA}$ )

### Red

Bin Code	Min.(nm)	Max.(nm)
RB	619	624

### Green

Bin Code	Min.(nm)	Max.(nm)
G7	520	525
G23	522.5	527.5
G8	525	530
G45	527.5	532.5
G9	530	535
G67	532.5	537.5
Ga	535	540

### Blue

Bin Code	Min.(nm)	Max.(nm)
B3	460	465
B23	462.5	467.5
B4	465	470
B45	467.5	472.5
B5	470	475
B67	472.5	477.5
B6	475	480

Tolerance of measurement of dominant wavelength is  $\pm 1 \text{ nm}$ .

**ORDER CODE TABLE\***

Kit Number	Color	Luminous Intensity (mcd)		Dominant Wavelength (nm)				Package
		Min.	Max.	Color Bin	Min. (nm)	Color Bin	Max. (nm)	
CLVBA-FKA-CAEDH8BBB7a363	Red	71	224	RB	619	RB	624	Reel
	Green	140	450	Any 1 hue bin from G7(520) - Ga(540)				Reel
	Blue	36	112	Any 1 hue bin from B3(460) - B6(480)				Reel
CLVBA-FKA-CA1D181BB7D3D3	Red	Any 1 Intensity bin from A(71) - E(224)		RB	619	RB	624	Reel
	Green	Any 1 Intensity bin from D(140) - H(450)		Any 1 hue bin from G7(520) - Ga(540)				Reel
	Blue	Any 1 Intensity bin from L8(36) - B(112)		Any 1 hue bin from B3(460) - B6(480)				Reel
CLVBA-FKA-CC1F1L1BB7D3D3	Red	Any 1 Intensity bin from C(112) - E(224)		RB	619	RB	624	Reel
	Green	Any 1 Intensity bin from F(224) - H(450)		Any 1 hue bin from G7(520) - Ga(540)				Reel
	Blue	Any 1 Intensity bin from L(56) - B(112)		Any 1 hue bin from B3(460) - B6(480)				Reel

Notes:

1. The above kit numbers represent the order codes which include multiple intensity-bin and color-bin codes. Only one intensity-bin code and one color-bin code will be shipped on each reel. Single intensity-bin code and single color-bin code will be orderable in certain quantities.
2. For example, any 1 intensity-bin from A - E means only 1 intensity-bin (A or 3a4 or B or 56 or C or 78 or D or 9a or E) will be shipped by Cree.
3. For example, any 1 color-bin from G7 - Ga means only 1 color-bin (G7 or G23 or G8 or G45 or G9 or G67 or Ga) will be shipped by Cree.
4. Please refer to the "Cree LED Lamp Reliability Test Standards" document for reliability test conditions.
5. Please refer to the "Cree LED Lamp Soldering & Handling" document for information about how to use this LED product safely.

## GRAPHS

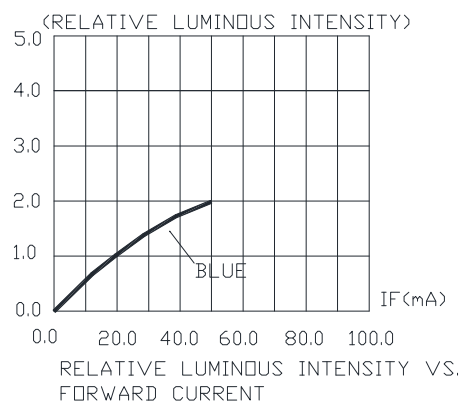
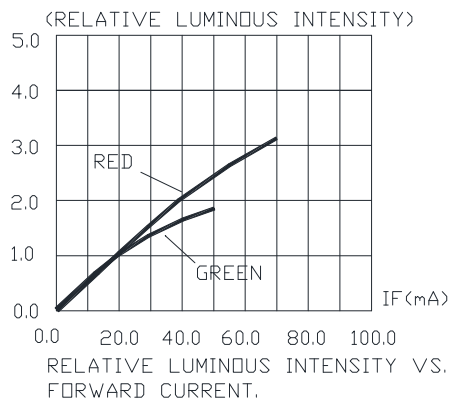
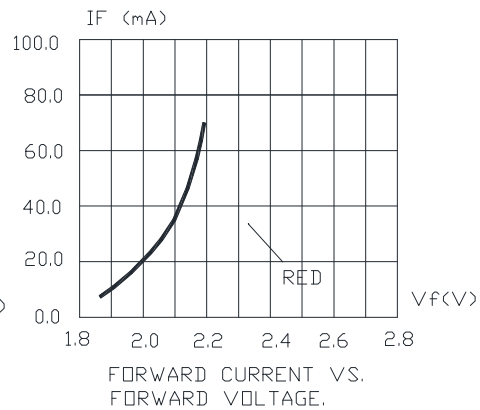
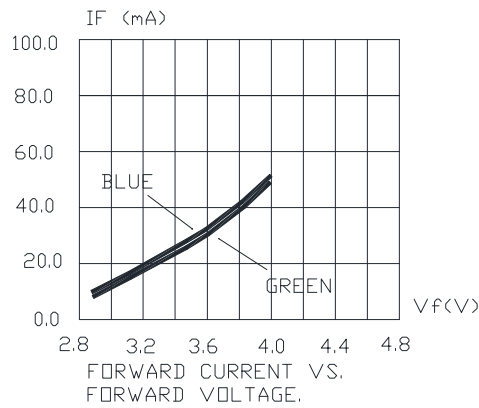
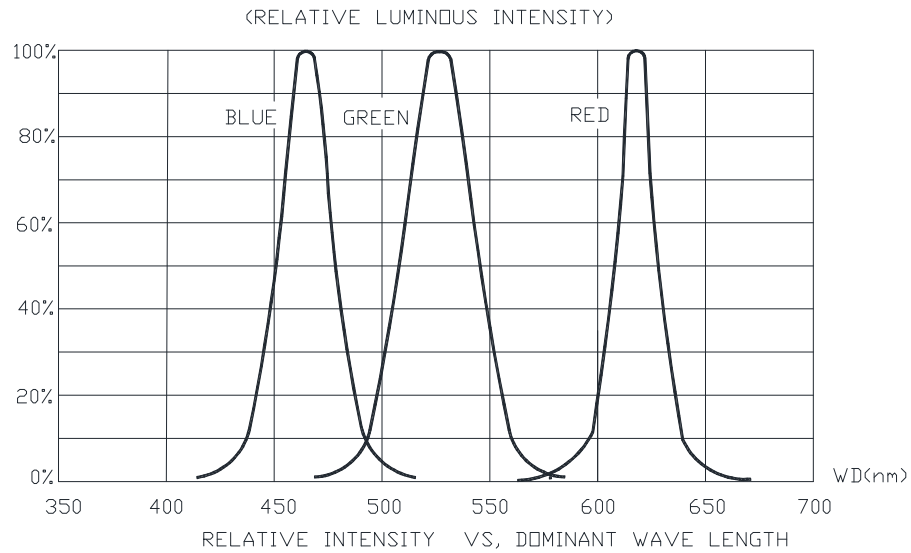

The above data are collected from statistical figures that do not necessarily correspond to the actual parameters of each single LED. Hence, these data will be changed without further notice.

## GRAPHS

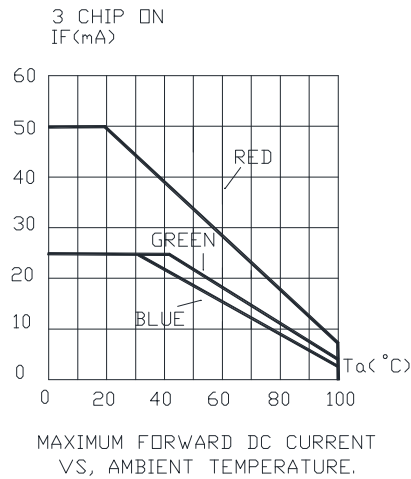
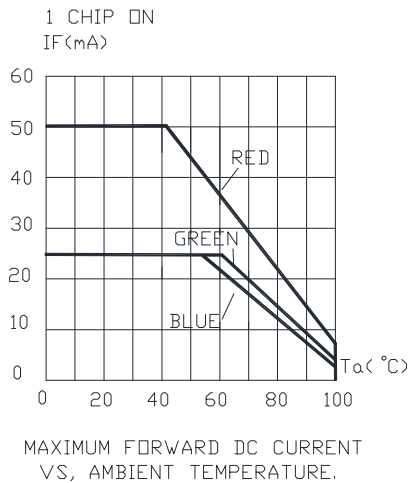
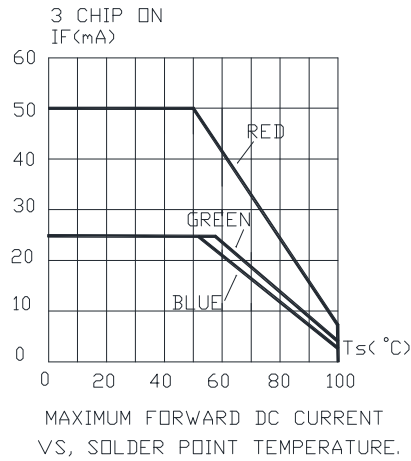
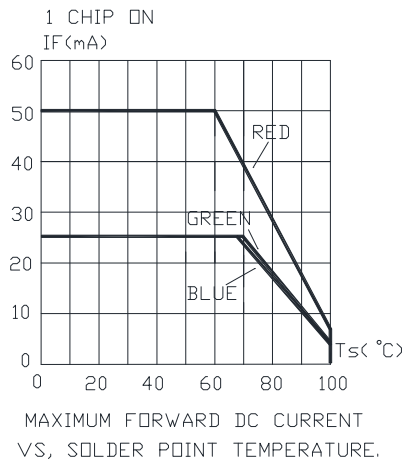
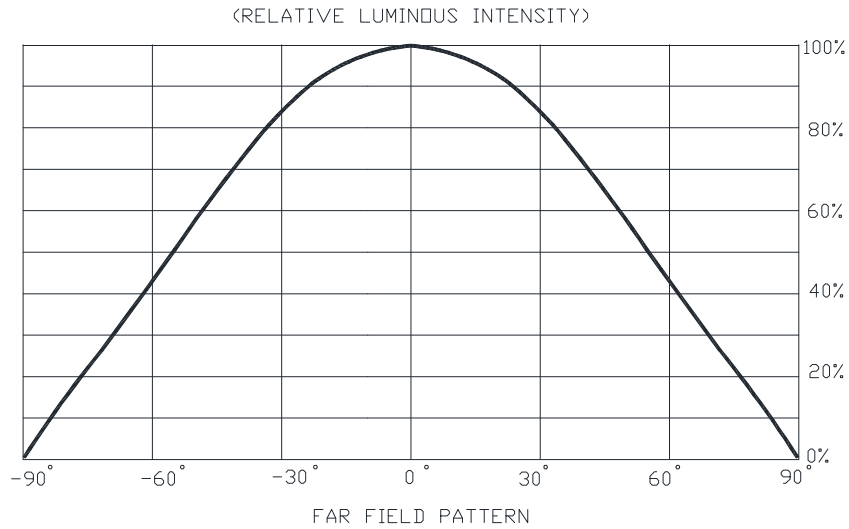

The above data are collected from statistical figures that do not necessarily correspond to the actual parameters of each single LED. Hence, these data will be changed without further notice.

## MECHANICAL DIMENSIONS

All dimensions are in mm.

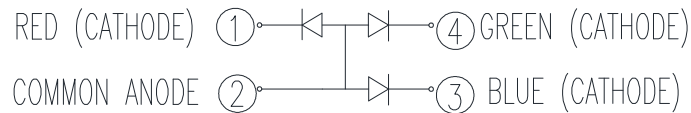
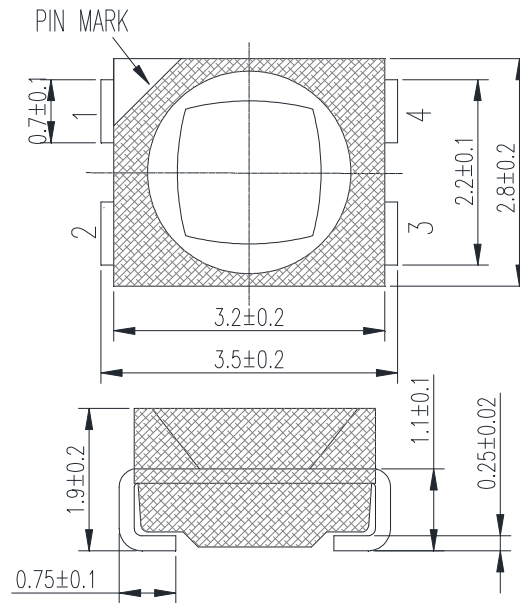

## NOTES

### RoHS Compliance

The levels of environmentally sensitive, persistent biologically toxic (PBT), persistent organic pollutants (POP), or otherwise restricted materials in this product are below the maximum concentration values (also referred to as the threshold limits) permitted for such substances, or are used in an exempted application, in accordance with EU Directive 2002/95/EC on the restriction of the use of certain hazardous substances in electrical and electronic equipment (RoHS), as amended through April 21, 2006.

### Vision Advisory Claim

Users should be cautioned not to stare at the light of this LED product. The bright light can damage the eye.

## KIT NUMBER SYSTEM

Cree LED lamps are tested and sorted into performance bins. A bin is specified by ranges of color, forward voltage, and brightness. Sorted LEDs are packaged for shipping in various convenient options. Please refer to the "Cree LED Lamp Packaging Standard" document for more information about shipping and packaging options.

Cree LEDs are sold by order codes in combinations of bins called kits. Order codes are configured in the following manner:

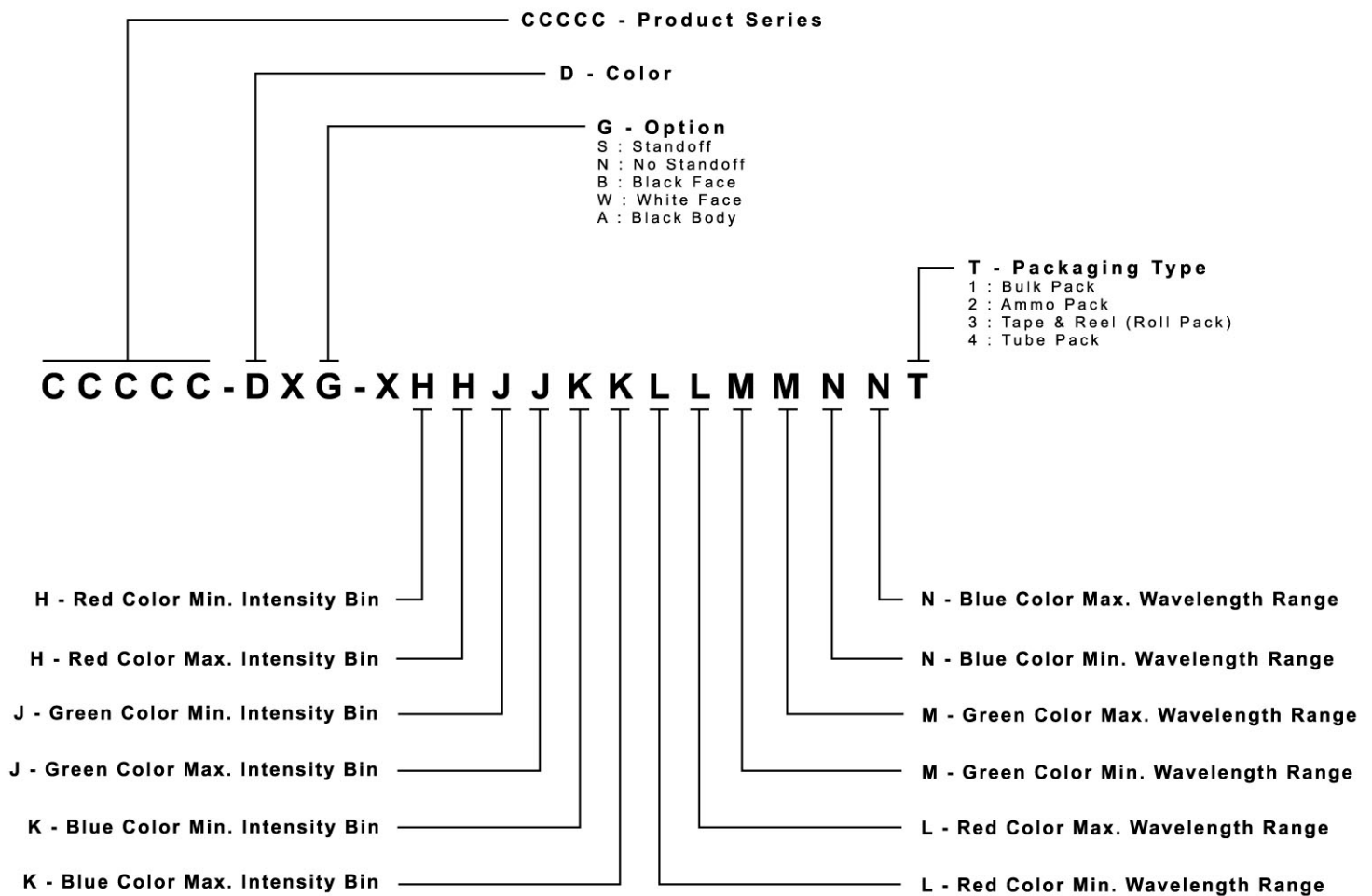



## REFLOW SOLDERING

- The CLVBA-FKA is rated as a MSL 5a product.
- The recommended floor life out of bag is 24hrs.
- The best practices suggestion is to bake 24-hour/80°C before use.
- The temperature profile is as below.

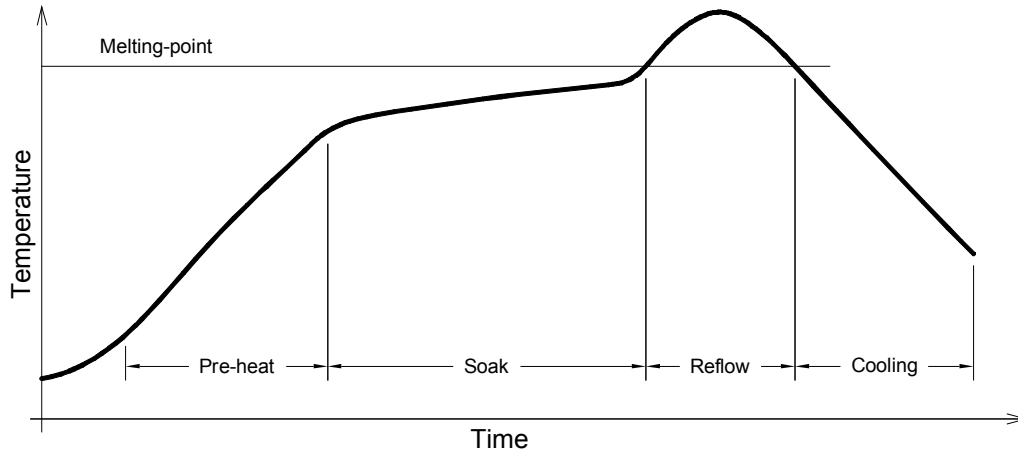

Use only with CLVBA-FKA

Solder
Average ramp-up rate = 4°C/s max
Preheat temperature = 150°C ~200°C
Preheat time = 120s max
Ramp-down rate = 6°C/s max
Peak temperature = 235°C max
Time within 5°C of actual Peak Temperature = 10s max
Duration above 217°C is 45s max

Soldering pad:

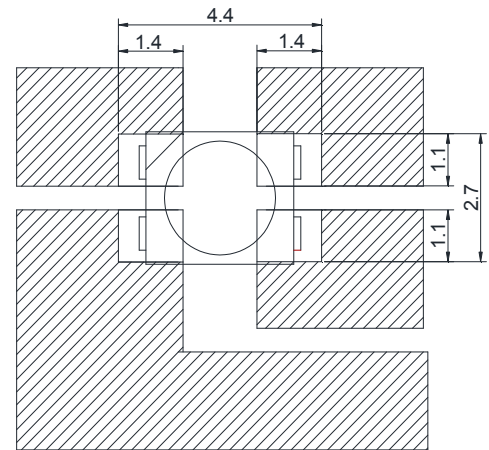

## PACKAGING

- The boxes are not water resistant and they must be kept away from water and moisture.
- The LEDs are packed in cardboard boxes after packaging in normal or anti-electrostatic bags.
- Cardboard boxes will be used to protect the LEDs from mechanical shocks during transportation.
- The reel pack is applied in SMD LED.
- Max 2000 pcs per reel.

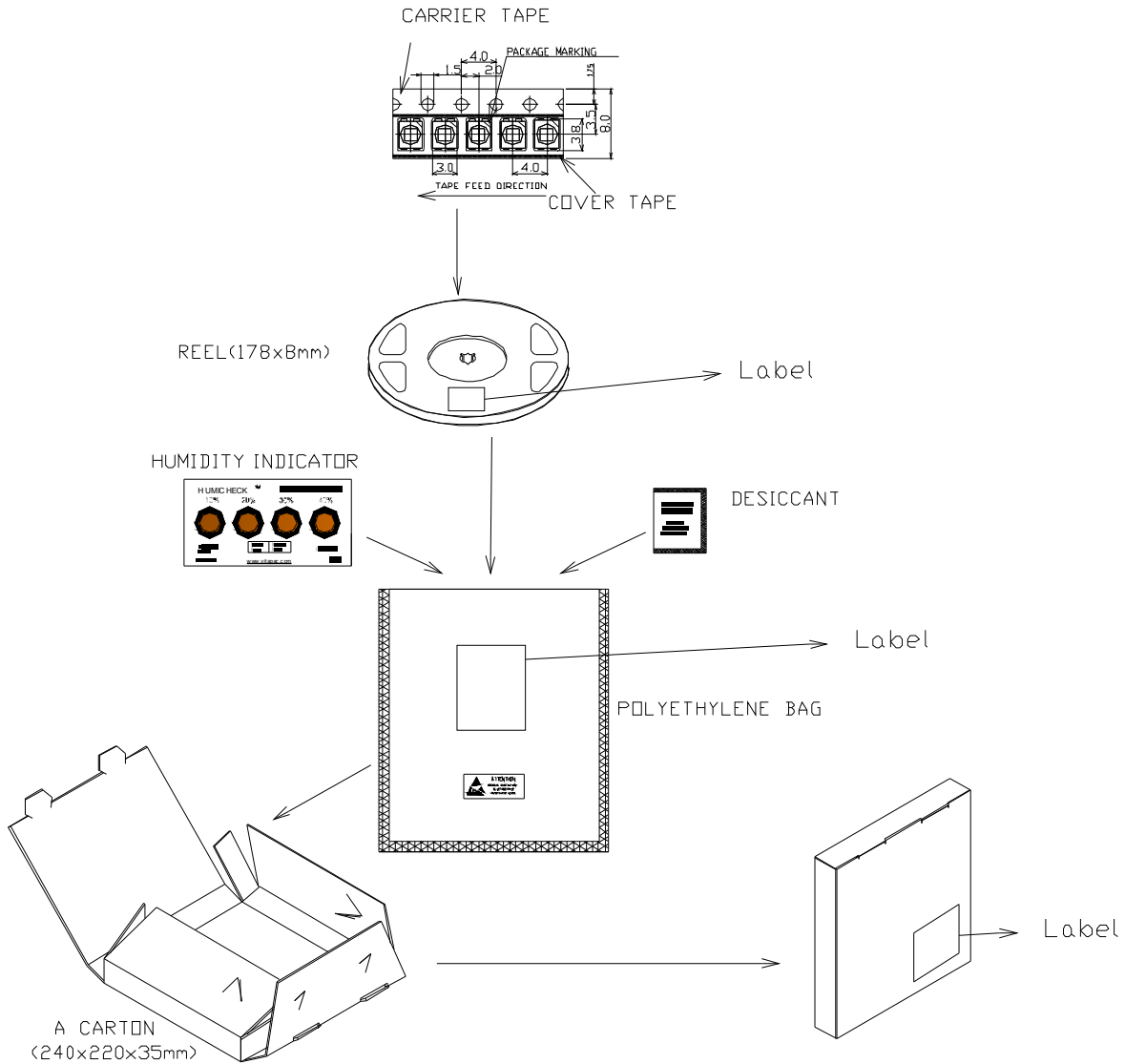

# Mouser Electronics

Authorized Distributor

Click to View Pricing, Inventory, Delivery & Lifecycle Information:

[Cree, Inc.:](#)

[CLVBA-FKA-CA1D181BB7R3R3](#) [CLVBA-FKA-CC1F1L1BB7R3R3](#) [CLVBA-FKA-CAEDH8BBB7A363](#) [CLYBA-FKA-CH1M1C1BB7D3D3](#) [CLYBA-FKA-CGJKNBEBB7A363](#) [CLYBA-FKA-CG1K1B1BB7D3D3](#) [CLVBA-FKA-CA1D181BB7D3D3](#) [CLVBA-FKA-CC1F1L1BB7D3D3](#)