

EMI Suppression Filters (for DC)/ Chip Inductors for Automotive

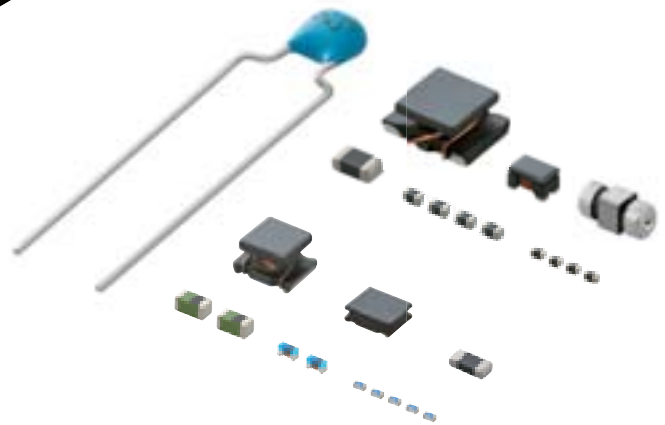

Explanation of category in this catalog



Infotainment

The product for entertainment equipment like car navigations, car audios, and body control equipment like wipers, power windows.



Powertrain, Safety



The product for high reliability applications like powertrain and safety, in addition to infotainment applications.

Explanation of symbols in this catalog

All Products					
 AEC-Q200	AEC-Q200 compliant product*	 Reflow OK	Reflow soldering applicable	 Flow OK	Flow soldering applicable

* Deviation may be submitted. Please contact us for details.

EMI Suppression Filters (for DC)					
 Hi Power	Meets large current lines	 GHz	Meets high frequency noise up to 1-2GHz	 Hi-GHz	Meets ultra high frequency noise up to 10GHz

Chip Inductors					
 Thickness XXmm max.	Max height xxmm	 Low Rdc	Low DC resistance type	 Bias	Bias current characteristics improved
 E-12 Step	E12 step inductance variation	 E-24 Step	E24 step inductance variation	 Hi Q	Hi Q type
 Tight Tolerance	Tight inductance tolerance available				

EU RoHS Compliant

- All the products in this catalog comply with EU RoHS.
- EU RoHS is "the European Directive 2011/65/EU on the Restriction of the Use of Certain Hazardous Substances in Electrical and Electronic Equipment."
- For more details, please refer to our website 'Murata's Approach for EU RoHS' (<http://www.murata.com/info/rohs.html>).

⚠Note • Please read rating and ⚠CAUTION (for storage, operating, rating, soldering, mounting and handling) in this catalog to prevent smoking and/or burning, etc.
• This catalog has only typical specifications. Therefore, please approve our product specifications or transact the approval sheet for product specifications before ordering.

Contents

Product specifications are as of July 2014.

■ Application Examples	2
------------------------------	---



EMI Suppression Filters (for DC)

Contents	7
EMI Suppression Filters (for DC) Product Guide	8
●BL□ Chip Ferrite Bead	10
●NF□ Chip EMIFIL®	82
●DL□/PL□ Chip Common Mode Choke Coil	102
●BNX Block Type EMIFIL®	125
●DS/VF/BNX EMI Suppression Filters (Lead Type) ..	131
●DX□ Microchip Transformer (Balun)	144



Chip Inductors

Contents	151
Classification and Structure of Chip Inductors	152
Chip Inductors Product Guide	154
●Inductors for Power Lines	156
●Inductors for General Circuits	197
●RF Inductors	207

■ Part Number Quick Reference	234
-------------------------------------	-----

Introduction of Web Site

■ Design Support Software SimSurfing	235
--	-----



Car Navigation System

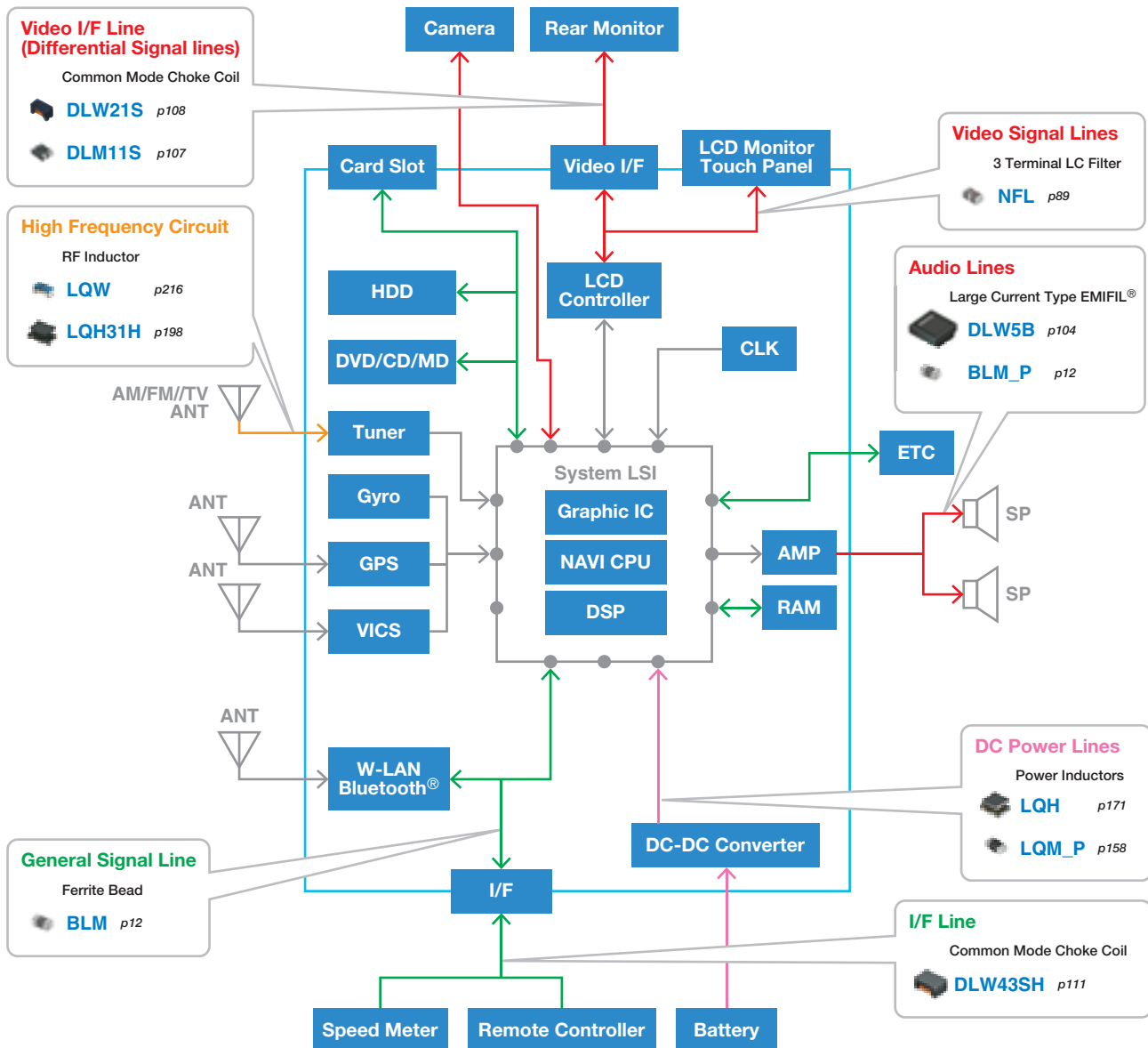

△Note • Please read rating and △CAUTION (for storage, operating, rating, soldering, mounting and handling) in this catalog to prevent smoking and/or burning, etc.
• This catalog has only typical specifications. Therefore, please approve our product specifications or transact the approval sheet for product specifications before ordering.



Car Camera System

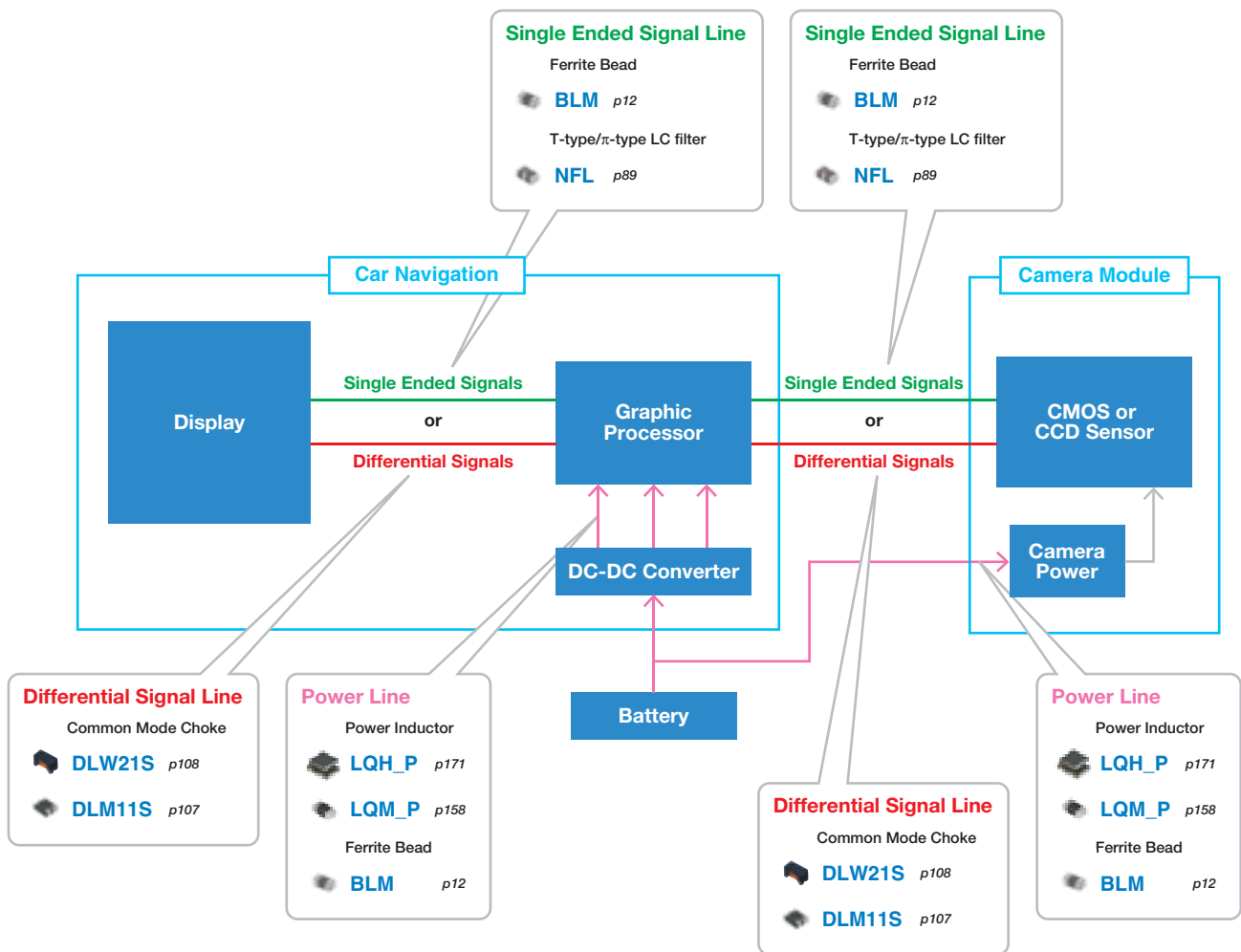

⚠Note • Please read rating and ⚠CAUTION (for storage, operating, rating, soldering, mounting and handling) in this catalog to prevent smoking and/or burning, etc.
 • This catalog has only typical specifications. Therefore, please approve our product specifications or transact the approval sheet for product specifications before ordering.



Electronic Control Unit

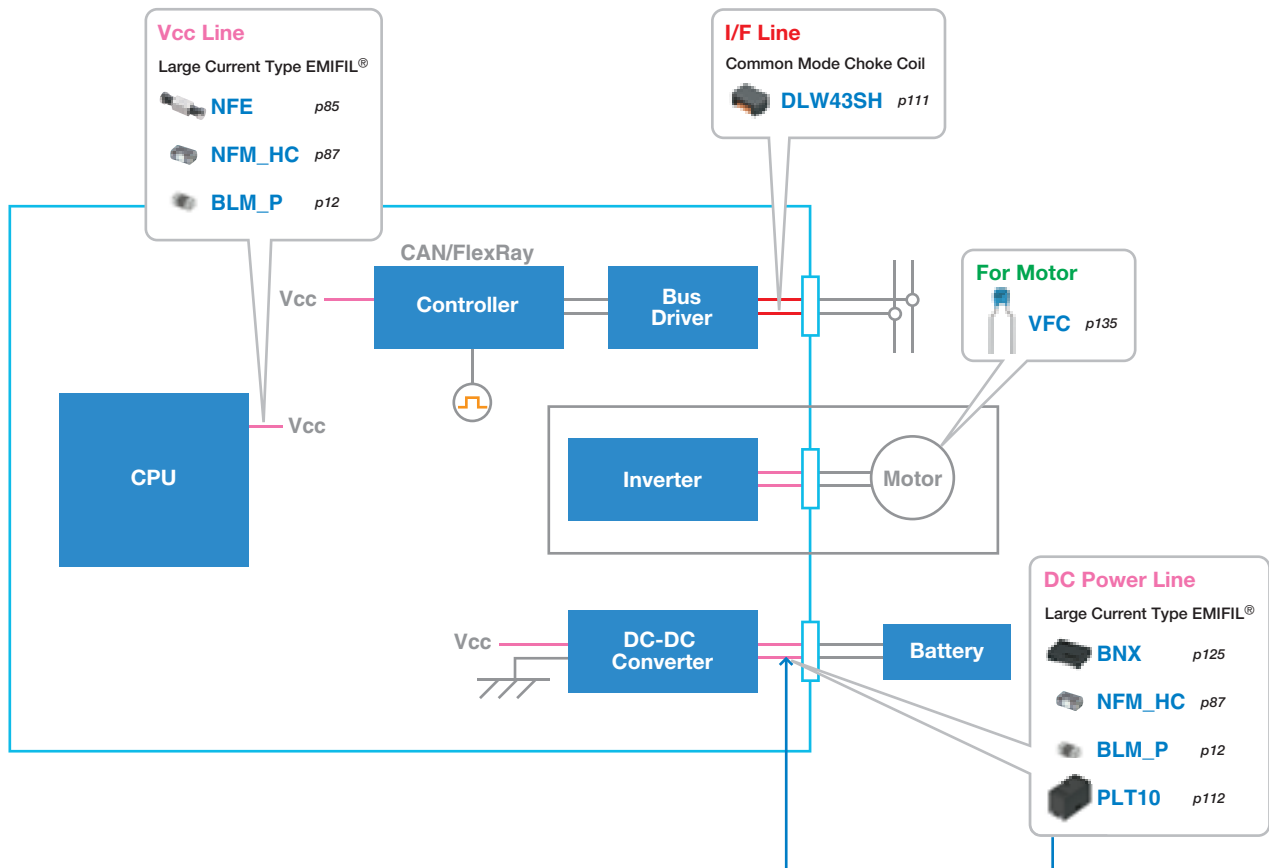

△Note • Please read rating and △CAUTION (for storage, operating, rating, soldering, mounting and handling) in this catalog to prevent smoking and/or burning, etc.
• This catalog has only typical specifications. Therefore, please approve our product specifications or transact the approval sheet for product specifications before ordering.



Smart Keyless Entry

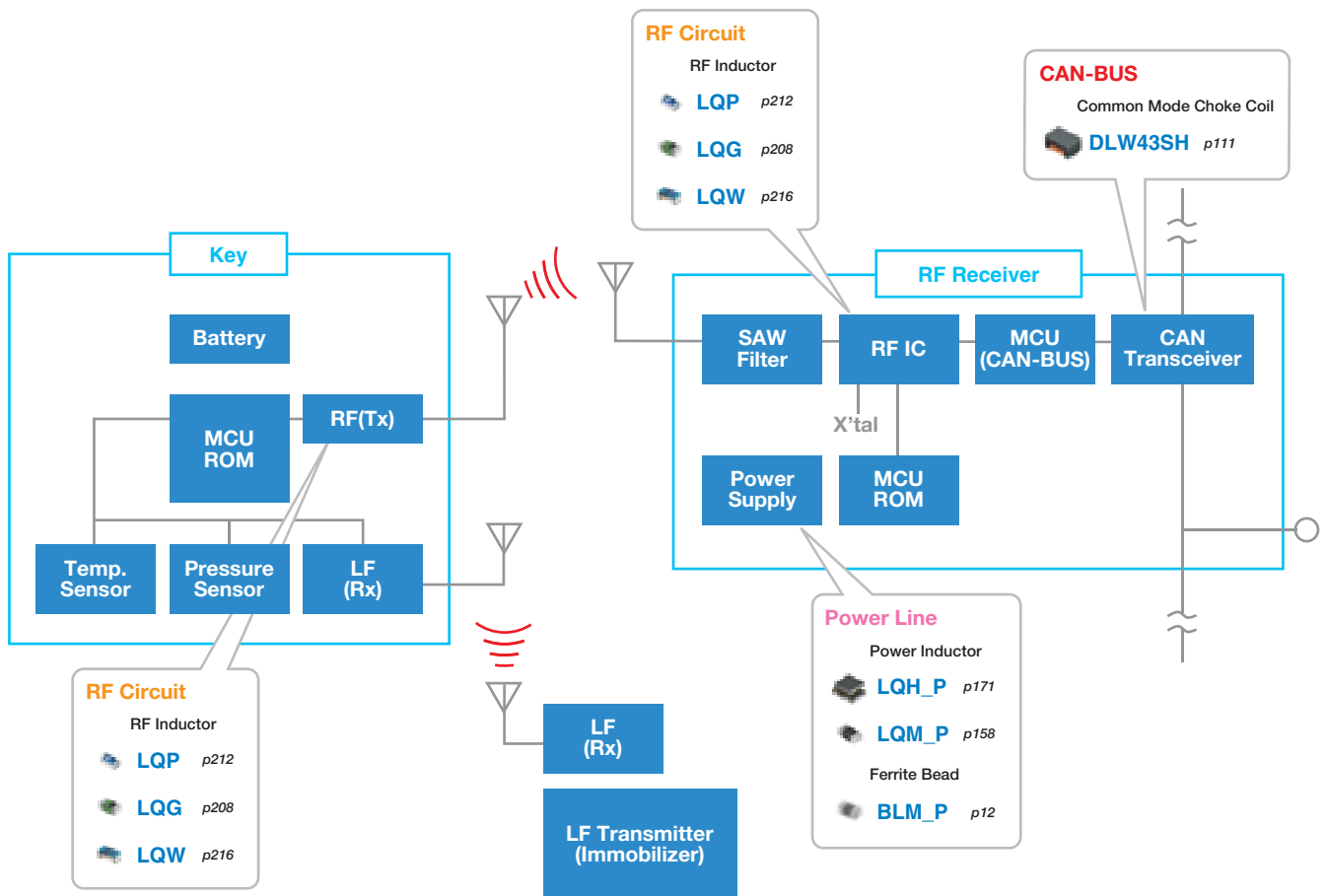

⚠Note • Please read rating and ⚠CAUTION (for storage, operating, rating, soldering, mounting and handling) in this catalog to prevent smoking and/or burning, etc.
 • This catalog has only typical specifications. Therefore, please approve our product specifications or transact the approval sheet for product specifications before ordering.



Telematics Circuit

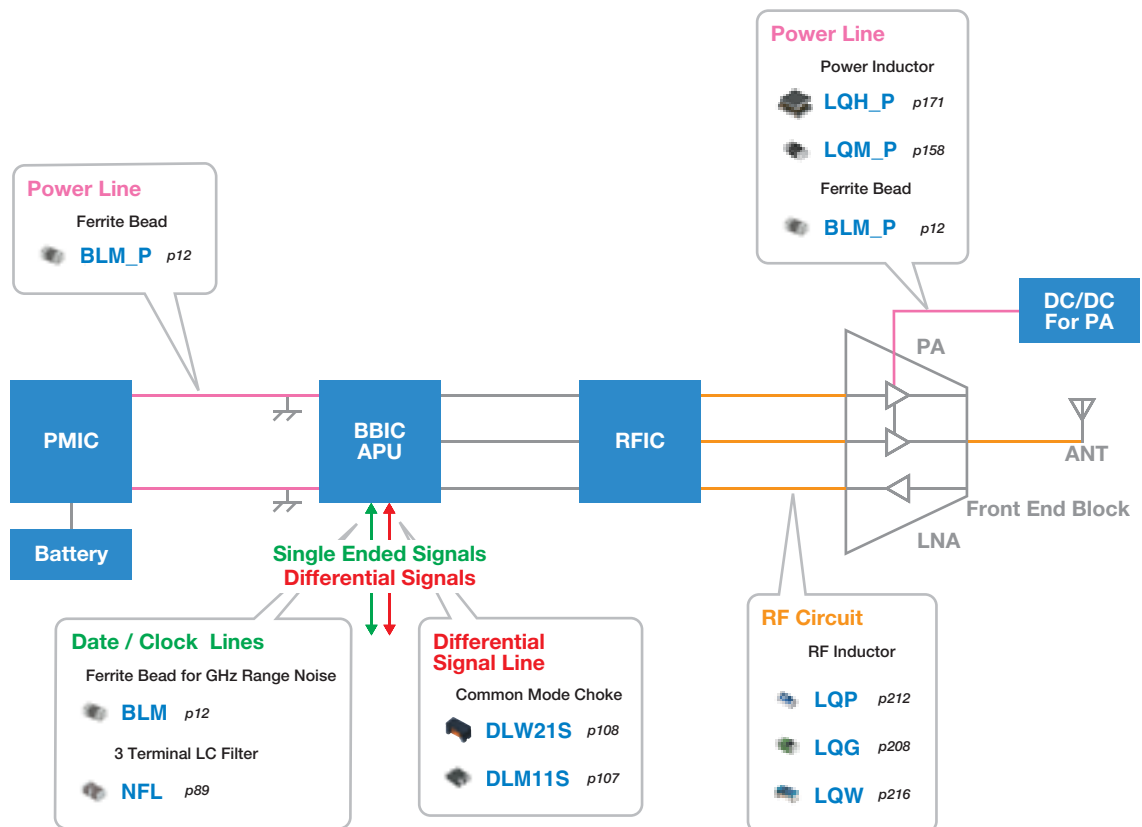

⚠Note • Please read rating and ⚠CAUTION (for storage, operating, rating, soldering, mounting and handling) in this catalog to prevent smoking and/or burning, etc.
 • This catalog has only typical specifications. Therefore, please approve our product specifications or transact the approval sheet for product specifications before ordering.



Contents

Product Guide	8
•BL□ Chip Ferrite Bead	
Part Numbering	10
Product Detail	12
⚠Caution/Notice	76
Soldering and Mounting	77
Packaging	81
•NF□ Chip EMIFIL®	
Part Numbering	82
Product Detail	85
⚠Caution/Notice	94
Soldering and Mounting	96
Packaging	101
•DL□/PL□ Chip Common Mode Choke Coil	
Part Numbering	102
Product Detail	104
⚠Caution/Notice	114
Soldering and Mounting	117
Packaging	123
•BNX Block Type EMIFIL®	
Product Detail	125
⚠Caution/Notice	127
Soldering and Mounting	128
Packaging	130
•DS/VF/BNX EMI Suppression Filters (Lead Type)	
Part Numbering	131
Product Detail	133
⚠Caution/Notice	138
Soldering and Mounting	140
Packaging	143
•DX□ Microchip Transformer (Balun)	
Part Numbering	144
Product Detail	145
⚠Caution/Notice	146
Soldering and Mounting	147
Packaging	149

SMD Type
Chip Ferrite Bead

SMD Type
Chip EMIFIL®

SMD Type
Chip Common Mode Choke Coil

SMD Type
Block Type EMIFIL®

Lead Type
EMI Suppression Filters

SMD Type
Microchip Transformer (Balun)

BL□

Inductor Type		Series	Size Code in inch (in mm)	Impedance (Ω) at 100MHz			Effective Frequency Range (Applicable Frequency Ranges are only for reference.)						
				10	100	1000	10kHz	100kHz	1MHz	10MHz	100MHz	1GHz	10GHz
For General Band Noise	Universal Type [Power Lines / Signal Lines]	BLM03AX <small>p15</small>	0201 (0603)	10	80 120	240 600 1000							
		BLM15AX <small>p25</small>	0402 (1005)	10	30 70 120 220	600 1000							
	Signal Lines Type	For General Signal Lines	BLM03AG <small>p17</small>	0201 (0603)	10	80 120 240	600 1000						
			BLM15AG <small>p27</small>	0402 (1005)	10	70 120 220	600 1000						
			BLM18AG <small>p41</small>	0603 (1608)		220 470	600 1000						
		For High Speed Signal Lines	BLM21AG <small>p51</small>	0805 (2012)		220 470	600 1000						
			BLM03B <small>p19</small>	0201 (0603)	10	22 33 56 80 47 75 120 240 470	600 1000 1800						
			BLM15B <small>p29</small>	0402 (1005)	5 10	22 33 47 75 120 220	470 1000 1800 2500						
	Power Lines Type	BLM18B <small>p44</small>	0603 (1608)	5 10	22 47 60 75 140 220 420 600 1500 2200	1000 1800 2500							
		BLM21B <small>p53</small>	0805 (2012)	5	60 75 120 200 330 470 750 1500 2200 2700	1000 1800 2250							
		BLM03PX* <small>p13</small>	0201 (0603)		22 (1.8A) 33 (1.5A) 80 (1A)								
		BLM03PG <small>p12</small>	0201 (0603)		22 (0.9A) 33 (0.75A)								
		BLM15PX* <small>p21</small>	0402 (1005)		33 (3A) 80 (2.3A) 180 (1.5A) 330 (1.2A) 600 (0.9A) 60 (2.5A) 120 (2A) 220 (1.4A) 470 (1A)								
		BLM15PG/PD* <small>p23</small>	0402 (1005)	10 (1A)	30 (2.2A) 80 (1.5A) 60 (1.7A) 120 (1.3A)								
		BLM18PG* <small>p35</small>	0603 (1608)		33 (3A) 70 (3.5A) 120 (2A) 220 (1.4A) 470 (1A) 30 (1A) 60 (0.5A) 180 (1.5A) 330 (1.2A)								
		BLM21PG* <small>p49</small>	0805 (2012)		30 (4A) 220 (2A) 22 (6A) 60 (3.5A) 120 (3A) 330 (1.5A)								
		BLM31PG* <small>p57</small>	1206 (3216)		50 (3.5A) 390 (2A) 33 (6A) 120 (3.5A) 600 (1.5A)								
		BLM41PG* <small>p59</small>	1806 (4516)		75 (3.5A) 470 (2A) 60 (6A) 180 (3.5A) 1000 (1.5A)								
		BLM18KG* <small>p37</small> (Low DC Resistance Type)	0603 (1608)		30 (5A) 70 (3.5A) 220 (2.2A) 470 (1.5A) 26 (6A) 100 (3A) 120 (3A) 330 (1.7A) 600 (1.3A)								
BLM18SG* <small>p39</small> (Low DC Resistance Type)	0603 (1608)		70 (4A) 220 (2.5A) 26 (6A) 120 (3A) 330 (1.5A)										
BLE32PN <small>p61</small>	1210 (3225)		30										
For GHz Band Noise	Universal Type [Power Lines / Signal Lines]	BLM03EB* <small>p64</small>	0201 (0603)		25 (0.6A) 50 (0.4A)								
		BLM15EG* <small>p67</small>	0402 (1005)		220 (0.7A) 120 (1.5A)								
		BLM18EG* <small>p72</small>	0603 (1608)		120 (2A) 330 (0.5A) 470 (0.5A) 100 (2A) 220 (2A/1A) 390 (0.5A) 600 (0.5A)								
		BLM18HE* <small>p69</small>	0603 (1608)		1000 (0.6A) 600 (0.8A) 1500 (0.5A)								
	Signal Lines Type	BLM03HG <small>p62</small>	0201 (0603)		600 1000 1200								
		BLM03HD <small>p62</small>	0201 (0603)		330 470 600 1000								
		BLM03HB <small>p62</small>	0201 (0603)		190								
		BLM15HG <small>p65</small>	0402 (1005)		600 1000								
		BLM15HD <small>p65</small>	0402 (1005)		600 1000 1800								
		BLM15HB <small>p65</small>	0402 (1005)		120 220								
		BLM18HG <small>p69</small>	0603 (1608)		600 470 1000								
		BLM18HD <small>p69</small>	0603 (1608)		600 470 1000								
		BLM18HB <small>p69</small>	0603 (1608)		120 220 330								
	For High-GHz Band Noise	Signal Lines Type	BLM15GG <small>p68</small>	0402 (1005)		220 470							
			BLM15GA <small>p68</small>	0402 (1005)		75							
BLM18GG <small>p75</small>			0603 (1608)		470								

* The derating of rated current is required for some items according to the operating temperature on each product page.

NF□

Capacitor Type	Series	Size Code in inch (in mm)	Capacitance (F)							Effective Frequency Range (Applicable Frequency Ranges are only for reference.)						
			10p	100p	1000p	10000p	0.1μ	1μ	10μ	10kHz	100kHz	1MHz	10MHz	100MHz	1GHz	10GHz
Universal Type [Power Lines / Signal Lines]	NFM21HC <small>p87</small>	0805 (2012)	22 47 100 220	470 1000	2200 22000	0.1 0.22	1									
	NFM31HK* <small>p88</small>	1206 (3216)			15000 10000 22000	0.1										

△Note • Please read rating and △CAUTION (for storage, operating, rating, soldering, mounting and handling) in this catalog to prevent smoking and/or burning, etc.
• This catalog has only typical specifications. Therefore, please approve our product specifications or transact the approval sheet for product specifications before ordering.



LC Combined Type		Series	Size Code in inch (in mm)	Cut-off Frequency (MHz)							Effective Frequency Range (Applicable Frequency Ranges are only for reference.) 10kHz 100kHz 1MHz 10MHz 100MHz 1GHz 10GHz							
Signal Lines Type		NFL18ZT ^{p89}	0603 (1608)	10	100	500												
					50	70	100	200	300	500								

LC Combined Type		Series	Size Code in inch (in mm)	Capacitance (pF)							Effective Frequency Range (Applicable Frequency Ranges are only for reference.) 10kHz 100kHz 1MHz 10MHz 100MHz 1GHz 10GHz							
Universal Type [Power Lines / Signal Lines]		NFE31ZT ^{p85}	1206 (3216)	22	47	100	220	470	2200									
		NFE61HT ^{p86}	2706 (6816)	33	68	180	360	1000	680	3300								

Inductor Type		Series	Size Code in inch (in mm)	Impedance (Ω) at 1MHz							Effective Frequency Range (Applicable Frequency Ranges are only for reference.) 10kHz 100kHz 1MHz 10MHz 100MHz 1GHz 10GHz							
Universal Type [Power Lines / Signal Lines]		NFZ32BW ^{p90}	1210 (3225)	1	10	100	1000											
				3.3	6.8	8.4	9.8	15	21	32	52	70	110	220	450	880		
				3.6	7.4	9	12	19	31	42	65	100	150	290	620			

DL□

Common Mode Choke Coils		Series	Size Code in inch (in mm)	Common Mode Impedance (Ω) at 100MHz							Effective Frequency Range (Applicable Frequency Ranges are only for reference.) 100kHz 1MHz 10MHz 100MHz 1GHz 10GHz							
Signal Lines Type	For Differential Signal Lines	DLM11S ^{p107}	0504 (1210)	45	90													
		DLW21S ^{p108}	0805 (2012)	67	120	180	260	490										
		DLW31S ^{p110}	1206 (3216)						2200									
Universal Type [Power Lines / Signal Lines]		DLW5BS* ^{p104}	2020 (5050)					500	800	600								
		DLW5AT*/DLW5BT* ^{p105}	2014 / 2020 (5036) / (5050)	50	110	230	330	500	1000	1400	45	100	150	250	400	850	1100	

Common Mode Choke Coils		Series	Size Code in inch (in mm)	Common Mode Inductance (μH) at 100MHz							Effective Frequency Range (Applicable Frequency Ranges are only for reference.) 100kHz 1MHz 10MHz 100MHz 1GHz 10GHz							
Signal Lines Type	For Differential Signal Lines	DLW43S ^{p111}	1812 (4532)	10	50	100												
				11	22	51	100											

PL□

Large Current Common Mode Choke Coil for Automotive Available		Series	Size Code in inch (in mm)	Common Mode Impedance (Ω) at 10MHz							Effective Frequency Range (Applicable Frequency Ranges are only for reference.) 100kHz 1MHz 10MHz 100MHz 1GHz 10GHz							
Power Lines Type		PLT10H* ^{p112}	—	45	100	400	900	1000										
		PLT5BP* ^{p113}	—	100	200	300	500											

BNX

Block EMIFIL®		Series	Height (mm)	Rated Voltage (Vdc)	Rated Current (A)	Effective Frequency Range (Applicable Frequency Ranges are only for reference.) 10kHz 100kHz 1MHz 10MHz 100MHz 1GHz 10GHz											
Power Lines Type	SMD Type	BNX024H01* ^{p125}	3.5	50	15												
		BNX025H01* ^{p125}	3.5	25	15												
		BNX026H01* ^{p125}	3.5	50	15												
		BNX027H01* ^{p125}	3.5	16	15												
	Lead Type	BNX012H01* ^{p136}	8.5 max.	50	15												

DS□

3-Terminal Capacitor Lead Type		Series	Height (mm)	Capacitance (F)										Effective Frequency Range (Applicable Frequency Ranges are only for reference.) 10kHz 100kHz 1MHz 10MHz 100MHz 1GHz 10GHz					
Universal Type [Power Lines / Signal Lines]		DSS1 ^{p133}	7.5 max.	10p	100p	1n	10n	100n											
				22	47	100	150	270	470	1.0	2.2	4.7	10	22	47				
				33	68	120	220	330	680	1.5	3.3	6.8	15	33	100				

VF□

Lead Type Capacitor with Varistor Function		Series	Height (mm)	Capacitance	Varistor Voltage
Power Lines Type		VFC2 ^{p135}	6.0 max.	1.0μF	27V

* The derating of rated current is required for some items according to the operating temperature on each product page.

△Note • Please read rating and △CAUTION (for storage, operating, rating, soldering, mounting and handling) in this catalog to prevent smoking and/or burning, etc.
• This catalog has only typical specifications. Therefore, please approve our product specifications or transact the approval sheet for product specifications before ordering.



BL Chip Ferrite Bead Part Numbering

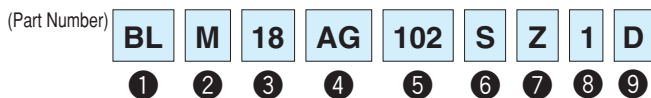

① Product ID

Product ID	
BL	Chip Ferrite Beads

② Type

Code	Type
E	DC Bias Characteristics Improved Type
M	Ferrite Bead Single Type

③ Dimensions (L×W)

Code	Dimensions (L×W)	EIA
03	0.6×0.3mm	0201
15	1.0×0.5mm	0402
18	1.6×0.8mm	0603
21	2.0×1.25mm	0805
31	3.2×1.6mm	1206
32	3.2×2.5mm	1210
41	4.5×1.6mm	1806

④ Characteristics/Applications

Code ^{*1}	Characteristics/Applications	Series
AG	For General Use	BLM03/15/18/21
AX		BLM03/15
BA	For High-speed Signal Lines	BLM15/18
BB		BLM03/15/18/21
BC		BLM03/15
BD		BLM03/15/18/21
BX		BLM15
PD		BLM15
PG	For Power Lines	BLM03/15/18/21/31/41
PN		BLE32
PX		BLM03/15
KG	For Power Lines (Low DC Resistance Type)	BLM18
SG		
HG	For GHz Band General Use	BLM03/15/18
EB	For GHz Band High-speed Signal Lines (Low Direct Current Type)	BLM03
EG	For GHz Band General Use (Low DC Resistance Type)	BLM15/18
HB	For GHz Band High-speed Signal Lines	BLM03/15/18
HD		BLM03/15/18
HE		BLM18
GA	For High-GHz Band High-speed Signal Lines	BLM15
GG	For High-GHz Band General Use	BLM15/18

*1 Frequency characteristics vary with each code.

⑤ Impedance

Expressed by three figures. The unit is in ohm (Ω) at 100MHz. The first and second figures are significant digits, and the third figure expresses the number of zeros that follow the two figures.

⑥ Electrode

Expressed by a letter.

Ex.)

Code	Electrode
S/T	Sn Plating
A	Au Plating
W	Ag/Pd

⑦ Category

Code	Category	
Z	For Automotive	Infotainment
H		Powertrain, Safety

⑧ Number of Circuits

Code	Number of Circuits
1	1 Circuit

Continued on the following page.

[△]Note • Please read rating and [△]CAUTION (for storage, operating, rating, soldering, mounting and handling) in this catalog to prevent smoking and/or burning, etc.
• This catalog has only typical specifications. Therefore, please approve our product specifications or transact the approval sheet for product specifications before ordering.

⑨ Packaging

Code	Packaging	Series
K	Embossed Taping (ø330mm Reel)	BLE, BLM21 ^{*1} /31/41
L	Embossed Taping (ø180mm Reel)	
B	Bulk	All Series
J	Paper Taping (ø330mm Reel)	BLM03/15/18/21 ^{*2}
D	Paper Taping (ø180mm Reel)	

*1 BLM21BD222S□1/BLM21BD272S□1 only.

*2 Except for BLM21BD222S□1/BLM21BD272S□1

SMD Type
Chip Ferrite Bead

SMD Type
Chip EMIFIL®

SMD Type
Chip Common Mode Choke Coil

SMD Type
Block Type EMIFIL®

Lead Type
EMI Suppression Filters

SMD Type
Microchip Transformer (Balun)

⚠Note • Please read rating and ⚠CAUTION (for storage, operating, rating, soldering, mounting and handling) in this catalog to prevent smoking and/or burning, etc.
• This catalog has only typical specifications. Therefore, please approve our product specifications or transact the approval sheet for product specifications before ordering.

BLM03PG Series 0201/0603 (inch/mm)

0201 size for power lines.

Appearance/Dimensions

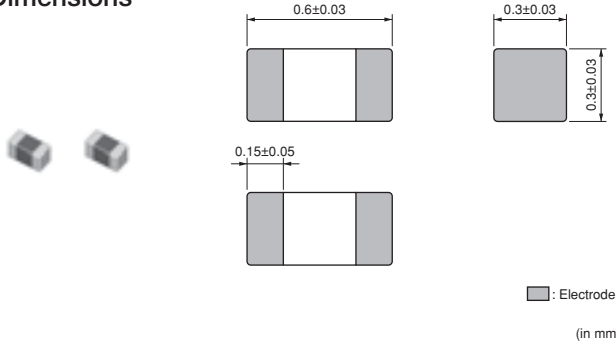

Packaging

Code	Packaging	Minimum Quantity
D	ø180mm Paper Taping	15000
J	ø330mm Paper Taping	50000
B	Packing in Bulk	1000



Equivalent Circuit

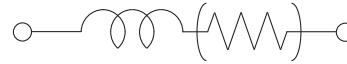

(Resistance element becomes dominant at high frequencies.)

Refer to pages from p.77 to p.80 for mounting information.

Rated Value (□: packaging code)

Part Number		Impedance (at 100MHz/20°C)	Rated Current	DC Resistance	Operating Temperature Range
For Infotainment	For Powertrain/Safety				
BLM03PG220SZ1□	—	22Ω ±25%	900mA	0.065Ω max.	-55°C~+125°C
BLM03PG330SZ1□	—	33Ω ±25%	750mA	0.090Ω max.	-55°C~+125°C

Number of Circuits: 1

Impedance-Frequency Characteristics (Main Items)

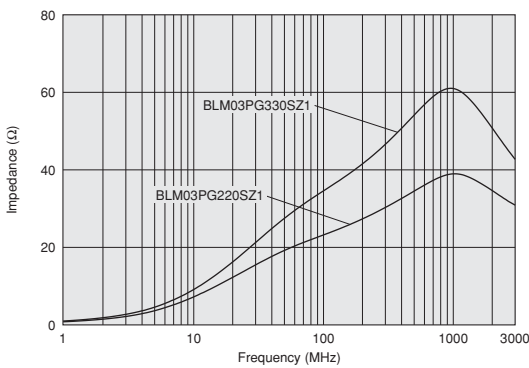

Impedance-Frequency Characteristics

BLM03PG220SZ1

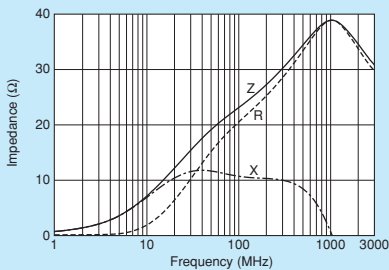

BLM03PG330SZ1

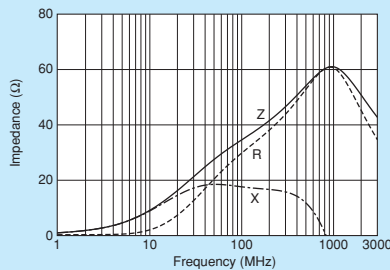

△Note • Please read rating and △CAUTION (for storage, operating, rating, soldering, mounting and handling) in this catalog to prevent smoking and/or burning, etc.
• This catalog has only typical specifications. Therefore, please approve our product specifications or transact the approval sheet for product specifications before ordering.

BLM03PX Series 0201/0603 (inch/mm)

Improved DC resistance meets larger current.

■ Appearance/Dimensions

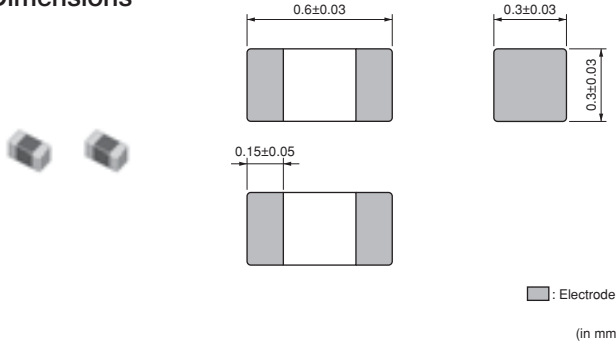

■ Packaging

Code	Packaging	Minimum Quantity
D	ø180mm Paper Taping	15000
J	ø330mm Paper Taping	50000
B	Packing in Bulk	1000



■ Equivalent Circuit

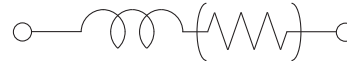

(Resistance element becomes dominant at high frequencies.)

Refer to pages from p.77 to p.80 for mounting information.

■ Rated Value (□: packaging code)

Part Number		Impedance (at 100MHz/20°C)	Rated Current	DC Resistance	Operating Temperature Range
For Infotainment	For Powertrain/Safety				
BLM03PX220SZ1□	—	22Ω ±25%	1800mA	0.040Ω max.	-55°C~+125°C
BLM03PX330SZ1□	—	33Ω ±25%	1500mA	0.055Ω max.	-55°C~+125°C
BLM03PX800SZ1□	—	80Ω ±25%	1000mA	0.130Ω max.	-55°C~+125°C

Number of Circuits: 1

■ Impedance-Frequency Characteristics (Main Items)

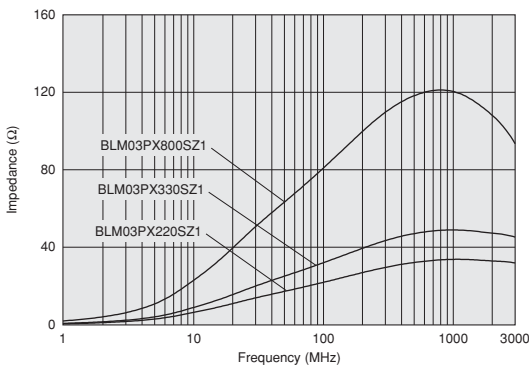

■ Derating of Rated Current

In operating temperature exceeding +85°C, derating of current is necessary for BLM03PX_S□1 series.

Please apply the derating curve shown in chart according to the operating temperature.

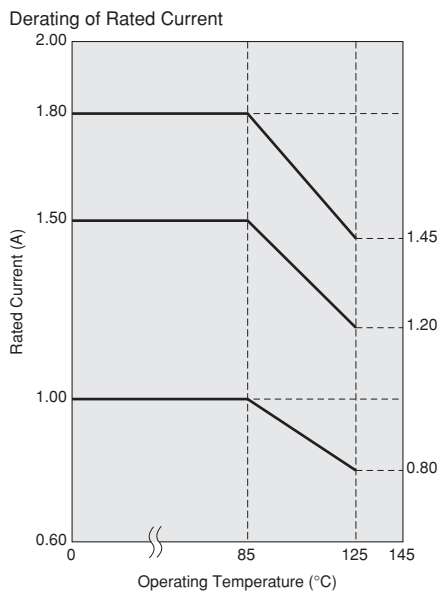

Continued on the following page.

⚠Note • Please read rating and ⚠CAUTION (for storage, operating, rating, soldering, mounting and handling) in this catalog to prevent smoking and/or burning, etc.
• This catalog has only typical specifications. Therefore, please approve our product specifications or transact the approval sheet for product specifications before ordering.

SMD Type Chip Ferrite Bead
SMD Type Chip EMIFIL®
SMD Type Chip Common Mode Choke Coil
SMD Type Block Type EMIFIL®
Lead Type EMI Suppression Filters
SMD Type Microchip Transformer (Balun)

■ Impedance-Frequency Characteristics

BLM03PX220SZ1

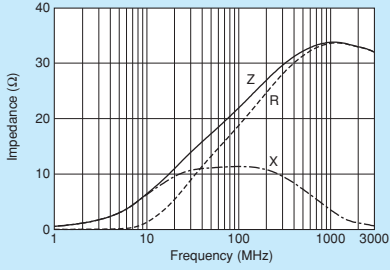

BLM03PX330SZ1

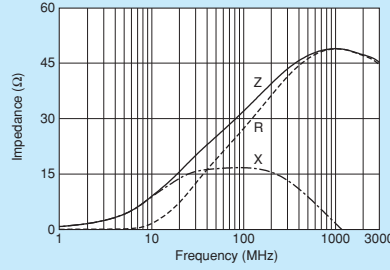

BLM03PX800SZ1

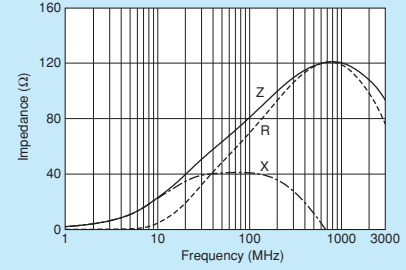

Chip Ferrite Bead
SMD Type

Chip EMIFIL®
SMD Type

Chip Common Mode Choke Coil
SMD Type

Block Type EMIFIL®
SMD Type

EMI Suppression Filters
Lead Type

Microchip Transformer (Balun)
SMD Type

⚠Note • Please read rating and ⚠CAUTION (for storage, operating, rating, soldering, mounting and handling) in this catalog to prevent smoking and/or burning, etc.
• This catalog has only typical specifications. Therefore, please approve our product specifications or transact the approval sheet for product specifications before ordering.

BLM03AX Series 0201/0603 (inch/mm)

High spec ferrite bead ultra low DC resistance and wide impedance line up. Fit for both power lines and signal lines.

Appearance/Dimensions

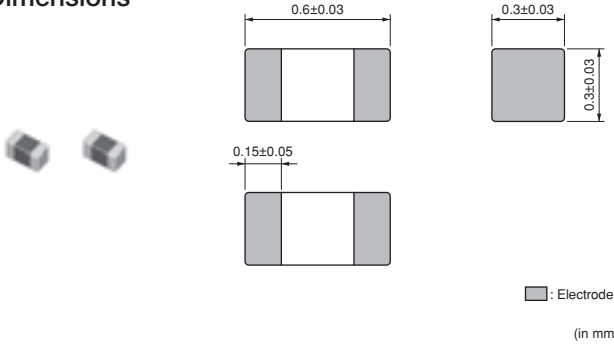

Packaging

Code	Packaging	Minimum Quantity
D	ø180mm Paper Taping	15000
J	ø330mm Paper Taping	50000
B	Packing in Bulk	1000



Equivalent Circuit

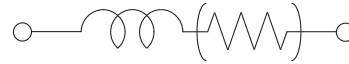

(Resistance element becomes dominant at high frequencies.)

Refer to pages from p.77 to p.80 for mounting information.

Rated Value (□: packaging code)

Part Number		Impedance (at 100MHz/20°C)	Rated Current	DC Resistance	Operating Temperature Range
For Infotainment	For Powertrain/Safety				
BLM03AX100SZ1□	—	10 Ω (Typ.)	1000mA	0.05Ω max.	-55°C~+125°C
BLM03AX800SZ1□	—	80 Ω ±25%	500mA	0.18Ω max.	-55°C~+125°C
BLM03AX121SZ1□	—	120 Ω ±25%	450mA	0.23Ω max.	-55°C~+125°C
BLM03AX241SZ1□	—	240 Ω ±25%	350mA	0.38Ω max.	-55°C~+125°C
BLM03AX601SZ1□	—	600 Ω ±25%	250mA	0.85Ω max.	-55°C~+125°C
BLM03AX102SZ1□	—	1000 Ω ±25%	200mA	1.25Ω max.	-55°C~+125°C

Number of Circuits: 1

Impedance-Frequency Characteristics (Main Items)

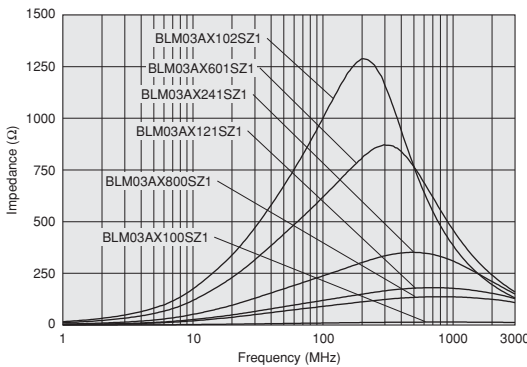

Impedance-Frequency Characteristics

BLM03AX100SZ1

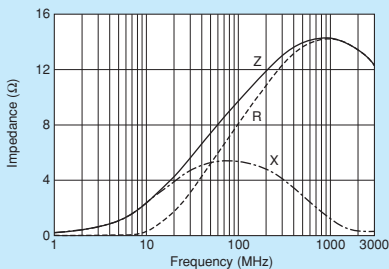

BLM03AX800SZ1

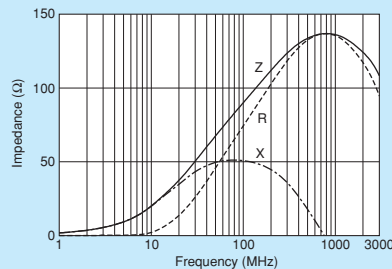

BLM03AX121SZ1

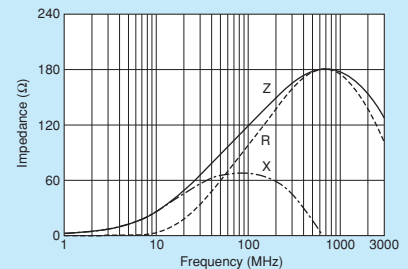

Continued on the following page.

△Note • Please read rating and △CAUTION (for storage, operating, rating, soldering, mounting and handling) in this catalog to prevent smoking and/or burning, etc.
• This catalog has only typical specifications. Therefore, please approve our product specifications or transact the approval sheet for product specifications before ordering.

SMD Type Chip Ferrite Bead
SMD Type Chip EMIFIL®
SMD Type Chip Common Mode Choke Coil
SMD Type Block Type EMIFIL®
Lead Type EMI Suppression Filters
SMD Type Microchip Transformer (Balun)

■ Impedance-Frequency Characteristics

BLM03AX241SZ1

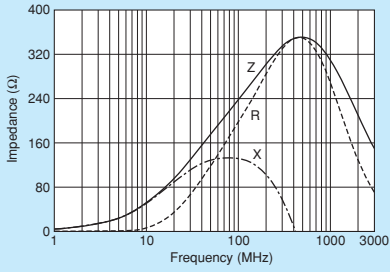

BLM03AX601SZ1

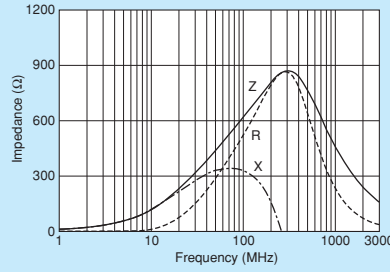

BLM03AX102SZ1

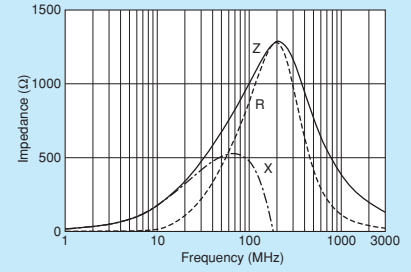

Chip Ferrite Bead
SMD Type

Chip EMIFIL®
SMD Type

Chip Common Mode Choke Coil
SMD Type

Block Type EMIFIL®
SMD Type

EMI Suppression Filters
Lead Type

Microchip Transformer (Balun)
SMD Type

⚠Note • Please read rating and ⚠CAUTION (for storage, operating, rating, soldering, mounting and handling) in this catalog to prevent smoking and/or burning, etc.
• This catalog has only typical specifications. Therefore, please approve our product specifications or transact the approval sheet for product specifications before ordering.

BLM03AG Series 0201/0603 (inch/mm)

0201 size for general signal lines.

■ Appearance/Dimensions

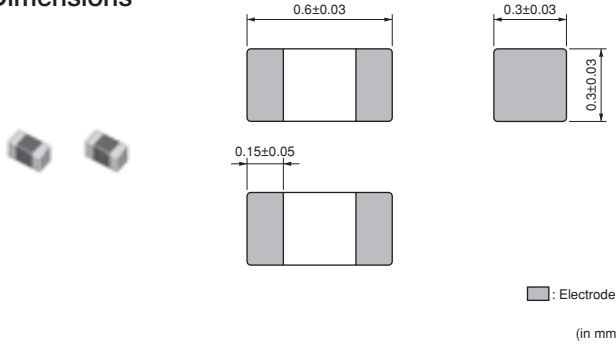

■ Packaging

Code	Packaging	Minimum Quantity
D	ø180mm Paper Taping	15000
J	ø330mm Paper Taping	50000
B	Packing in Bulk	1000



■ Equivalent Circuit

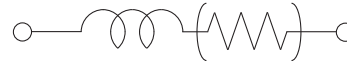

(Resistance element becomes dominant at high frequencies.)

Refer to pages from p.77 to p.80 for mounting information.

■ Rated Value (□: packaging code)

Part Number		Impedance (at 100MHz/20°C)	Rated Current	DC Resistance	Operating Temperature Range
For Infotainment	For Powertrain/Safety				
BLM03AG100SZ1□	—	10 Ω (Typ.)	500mA	0.1 Ω max.	-55°C ~ +125°C
BLM03AG700SZ1□	—	70 Ω (Typ.)	200mA	0.4 Ω max.	-55°C ~ +125°C
BLM03AG800SZ1□	—	80 Ω ±25%	200mA	0.4 Ω max.	-55°C ~ +125°C
BLM03AG121SZ1□	—	120 Ω ±25%	200mA	0.5 Ω max.	-55°C ~ +125°C
BLM03AG241SZ1□	—	240 Ω ±25%	200mA	0.8 Ω max.	-55°C ~ +125°C
BLM03AG601SZ1□	—	600 Ω ±25%	100mA	1.5 Ω max.	-55°C ~ +125°C
BLM03AG102SZ1□	—	1000 Ω ±25%	100mA	2.5 Ω max.	-55°C ~ +125°C

Number of Circuits: 1

■ Impedance-Frequency Characteristics (Main Items)

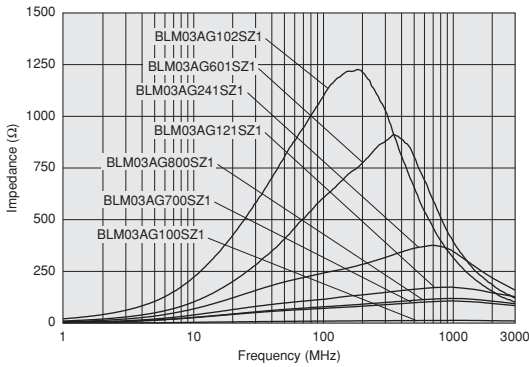

■ Impedance-Frequency Characteristics

BLM03AG100SZ1

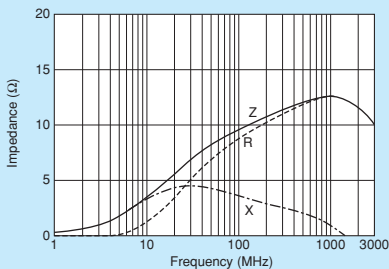

BLM03AG700SZ1

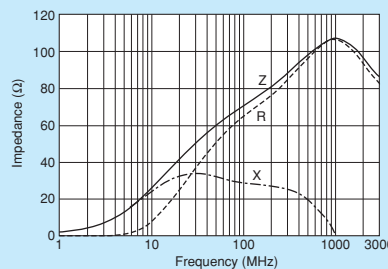

BLM03AG800SZ1

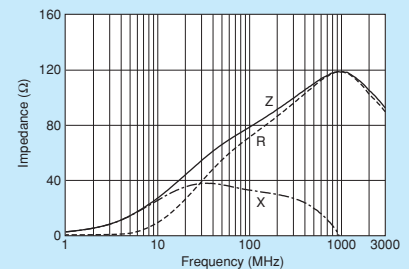

Continued on the following page.

△Note • Please read rating and △CAUTION (for storage, operating, rating, soldering, mounting and handling) in this catalog to prevent smoking and/or burning, etc.
• This catalog has only typical specifications. Therefore, please approve our product specifications or transact the approval sheet for product specifications before ordering.

■ Impedance-Frequency Characteristics

BLM03AG121SZ1

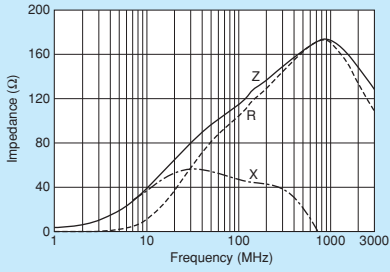

BLM03AG241SZ1

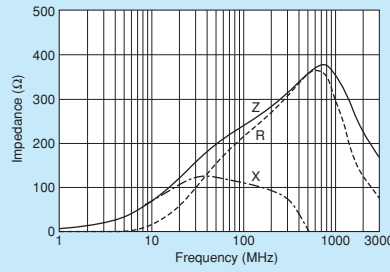

BLM03AG601SZ1

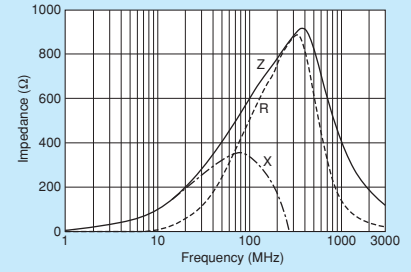

BLM03AG102SZ1

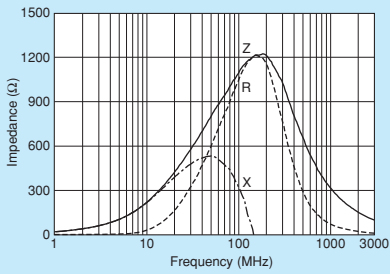

Chip Ferrite Bead
SMD Type

Chip EMIFIL®
SMD Type

Chip Common Mode Choke Coil
SMD Type

Block Type EMIFIL®
SMD Type

EMI Suppression Filters
Lead Type

Microchip Transformer (Balun)
SMD Type

⚠Note • Please read rating and ⚠CAUTION (for storage, operating, rating, soldering, mounting and handling) in this catalog to prevent smoking and/or burning, etc.
• This catalog has only typical specifications. Therefore, please approve our product specifications or transact the approval sheet for product specifications before ordering.

BLM03B Series 0201/0603 (inch/mm)

0201 size for high speed signal lines.

■ Appearance/Dimensions

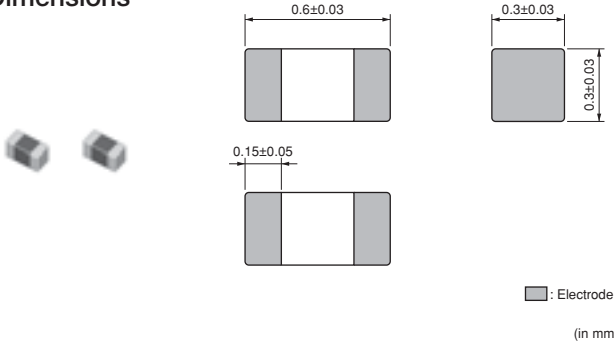

■ Packaging

Code	Packaging	Minimum Quantity
D	ø180mm Paper Taping	15000
J	ø330mm Paper Taping	50000
B	Packing in Bulk	1000



■ Equivalent Circuit

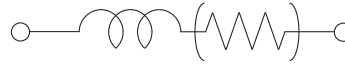

(Resistance element becomes dominant at high frequencies.)

Refer to pages from p.77 to p.80 for mounting information.

■ Rated Value (□: packaging code)

Part Number		Impedance (at 100MHz/20°C)	Rated Current	DC Resistance	Operating Temperature Range
For Infotainment	For Powertrain/Safety				
BLM03BD750SZ1□	—	75 Ω ±25%	300mA	0.4 Ω max.	-55°C ~ +125°C
BLM03BD121SZ1□	—	120 Ω ±25%	250mA	0.5 Ω max.	-55°C ~ +125°C
BLM03BD241SZ1□	—	240 Ω ±25%	200mA	0.8 Ω max.	-55°C ~ +125°C
BLM03BD471SZ1□	—	470 Ω ±25%	215mA	1.5 Ω max.	-55°C ~ +125°C
BLM03BD601SZ1□	—	600 Ω ±25%	200mA	1.7 Ω max.	-55°C ~ +125°C
BLM03BB100SZ1□	—	10 Ω ±25%	300mA	0.4 Ω max.	-55°C ~ +125°C
BLM03BB220SZ1□	—	22 Ω ±25%	200mA	0.5 Ω max.	-55°C ~ +125°C
BLM03BB470SZ1□	—	47 Ω ±25%	200mA	0.7 Ω max.	-55°C ~ +125°C
BLM03BB750SZ1□	—	75 Ω ±25%	200mA	1.0 Ω max.	-55°C ~ +125°C
BLM03BB121SZ1□	—	120 Ω ±25%	100mA	1.5 Ω max.	-55°C ~ +125°C
BLM03BC330SZ1□	—	33 Ω ±25%	150mA	0.85 Ω max.	-55°C ~ +125°C
BLM03BC560SZ1□	—	56 Ω ±25%	100mA	1.05 Ω max.	-55°C ~ +125°C
BLM03BC800SZ1□	—	80 Ω ±25%	100mA	1.40 Ω max.	-55°C ~ +125°C

Number of Circuits: 1

■ Impedance-Frequency Characteristics (Main Items)

BLM03BD Series

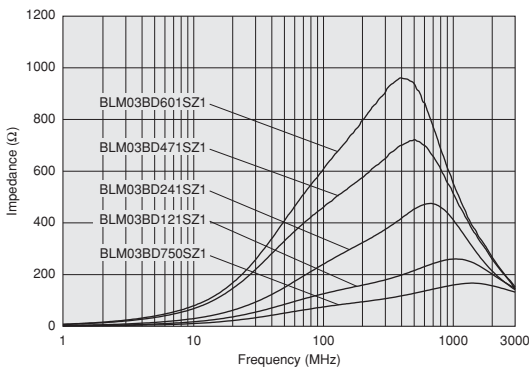

BLM03BB Series

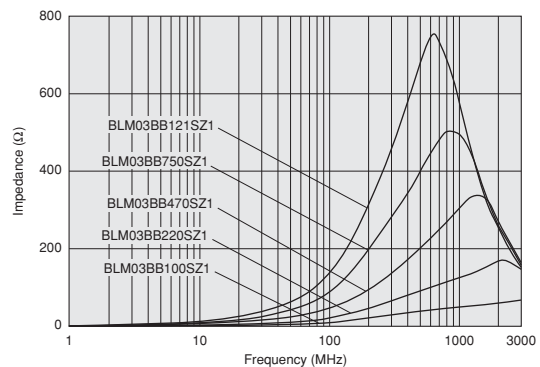

Continued on the following page.

△Note • Please read rating and △CAUTION (for storage, operating, rating, soldering, mounting and handling) in this catalog to prevent smoking and/or burning, etc.
• This catalog has only typical specifications. Therefore, please approve our product specifications or transact the approval sheet for product specifications before ordering.

Impedance-Frequency Characteristics (Main Items)

BLM03BC Series

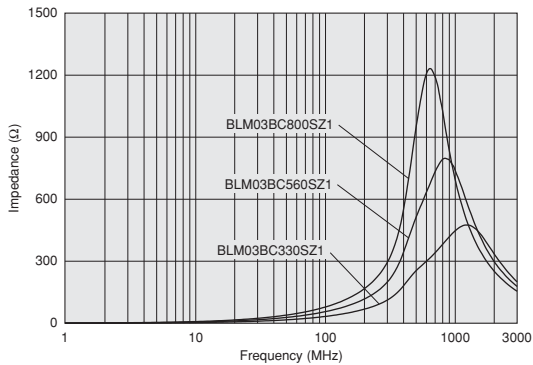

Impedance-Frequency Characteristics

BLM03BD750SZ1

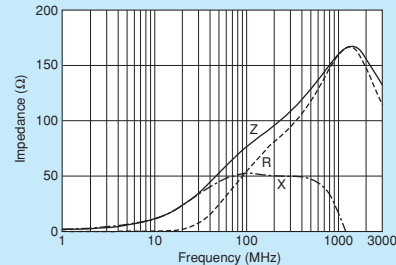

BLM03BD121SZ1

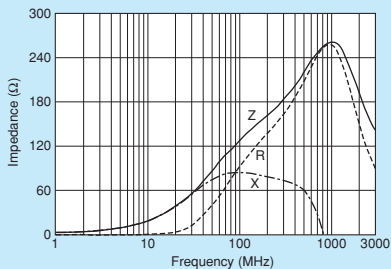

BLM03BD241SZ1

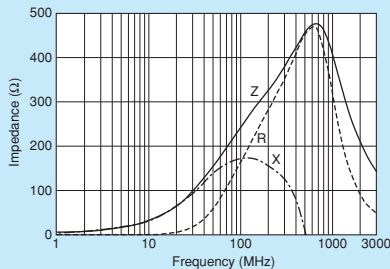

BLM03BD471SZ1

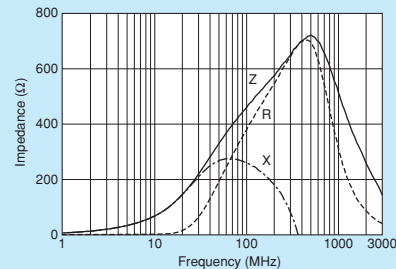

BLM03BD601SZ1

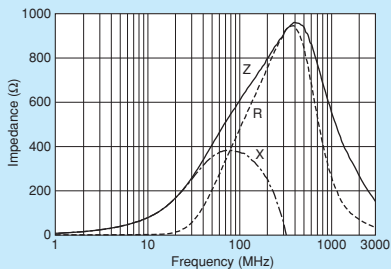

BLM03BB100SZ1

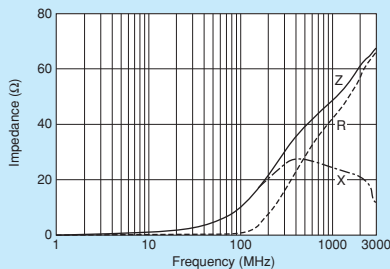

BLM03BB220SZ1

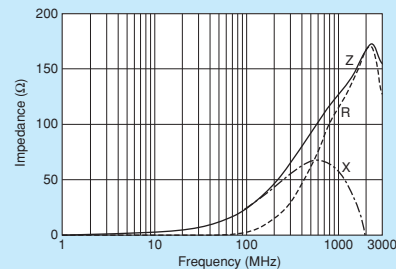

BLM03BB470SZ1

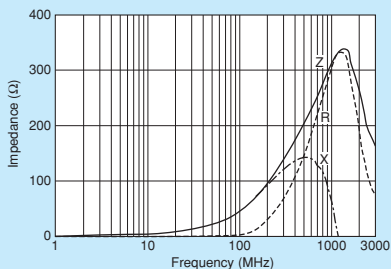

BLM03BB750SZ1

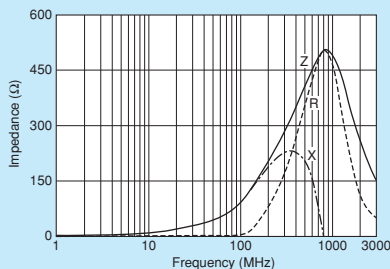

BLM03BB121SZ1

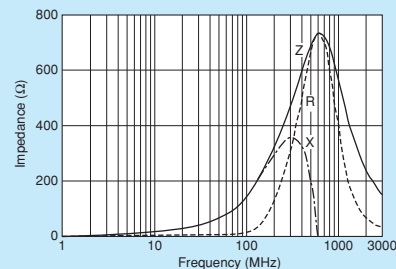

BLM03BC330SZ1

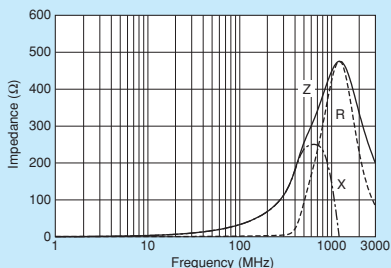

BLM03BC560SZ1

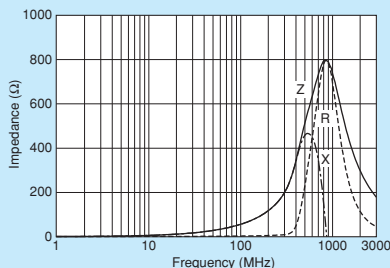

BLM03BC800SZ1

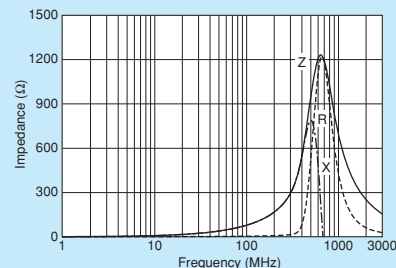

Note • Please read rating and CAUTION (for storage, operating, rating, soldering, mounting and handling) in this catalog to prevent smoking and/or burning, etc.
 • This catalog has only typical specifications. Therefore, please approve our product specifications or transact the approval sheet for product specifications before ordering.

BLM15PX Series 0402/1005 (inch/mm)

3A max., high performance type for power lines up to 600ohm.

■ Appearance/Dimensions

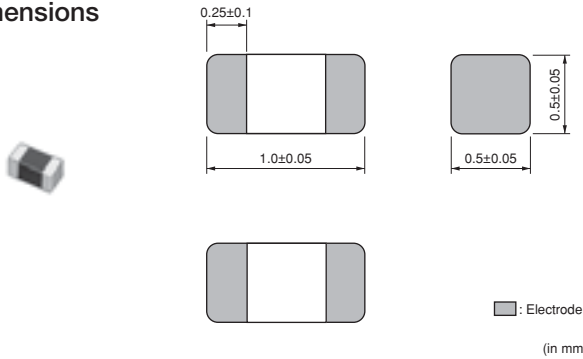

■ Packaging

Code	Packaging	Minimum Quantity
D	ø180mm Paper Taping	10000
J	ø330mm Paper Taping	50000
B	Packing in Bulk	1000



■ Equivalent Circuit

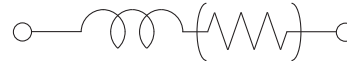

(Resistance element becomes dominant at high frequencies.)

Refer to pages from p.77 to p.80 for mounting information.

■ Rated Value (□: packaging code)

Part Number		Impedance (at 100MHz/20°C)	Rated Current	DC Resistance	Operating Temperature Range
For Infotainment	For Powertrain/Safety				
BLM15PX330SZ1□	—	33Ω ±25%	3000mA	0.022Ω max.	-55°C~+125°C
BLM15PX600SZ1□	—	60Ω ±25%	2500mA	0.032Ω max.	-55°C~+125°C
BLM15PX800SZ1□	—	80Ω ±25%	2300mA	0.038Ω max.	-55°C~+125°C
BLM15PX121SZ1□	—	120Ω ±25%	2000mA	0.055Ω max.	-55°C~+125°C
BLM15PX181SZ1□	—	180Ω ±25%	1500mA	0.090Ω max.	-55°C~+125°C
BLM15PX221SZ1□	—	220Ω ±25%	1400mA	0.10Ω max.	-55°C~+125°C
BLM15PX331SZ1□	—	330Ω ±25%	1200mA	0.15Ω max.	-55°C~+125°C
BLM15PX471SZ1□	—	470Ω ±25%	1000mA	0.20Ω max.	-55°C~+125°C
BLM15PX601SZ1□	—	600Ω ±25%	900mA	0.23Ω max.	-55°C~+125°C

Number of Circuits: 1

■ Impedance-Frequency Characteristics (Main Items)

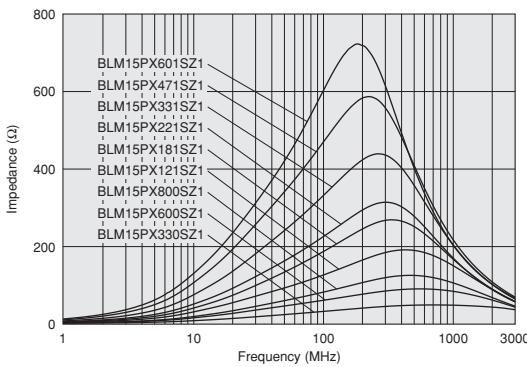

■ Derating of Rated Current

In operating temperature exceeding +85°C, derating of current is necessary for BLM15PX series.

Please apply the derating curve shown in chart according to the operating temperature.

Derating of Rated Current

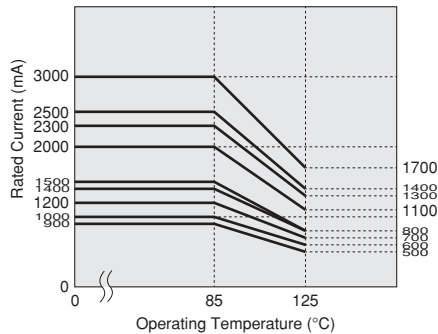

Continued on the following page. ↗

△Note • Please read rating and △CAUTION (for storage, operating, rating, soldering, mounting and handling) in this catalog to prevent smoking and/or burning, etc.
• This catalog has only typical specifications. Therefore, please approve our product specifications or transact the approval sheet for product specifications before ordering.

Impedance-Frequency Characteristics

BLM15PX330SZ1

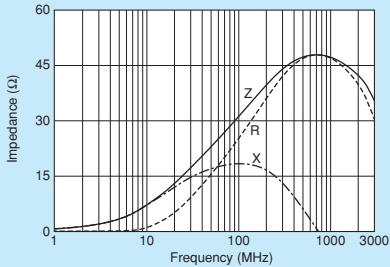

BLM15PX600SZ1

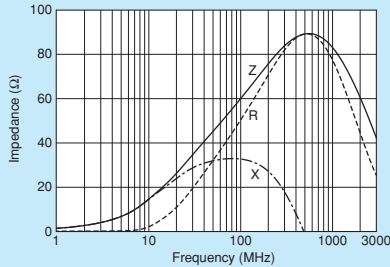

BLM15PX800SZ1

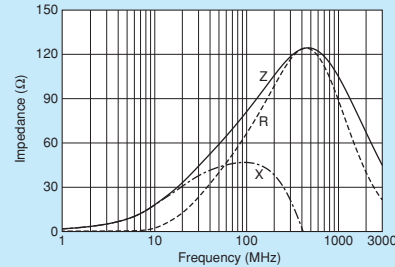

BLM15PX121SZ1

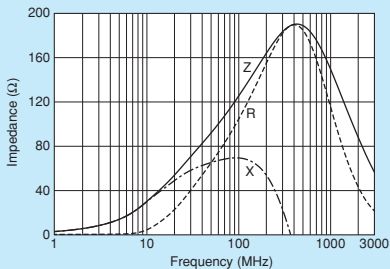

BLM15PX181SZ1

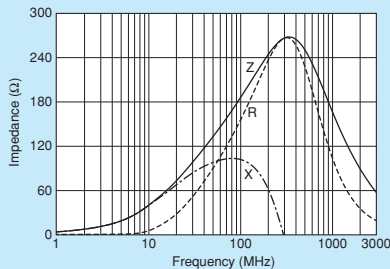

BLM15PX221SZ1

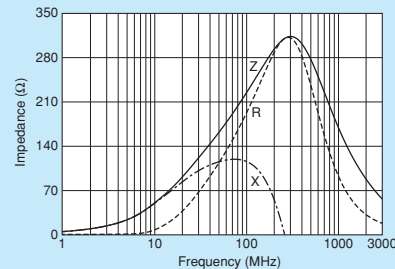

BLM15PX331SZ1

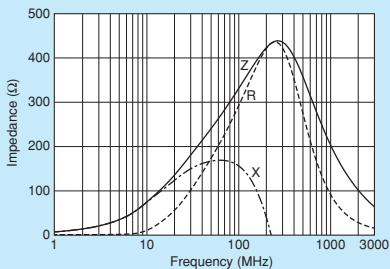

BLM15PX471SZ1

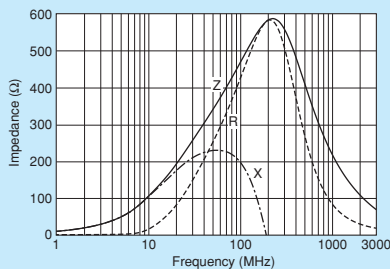

BLM15PX601SZ1

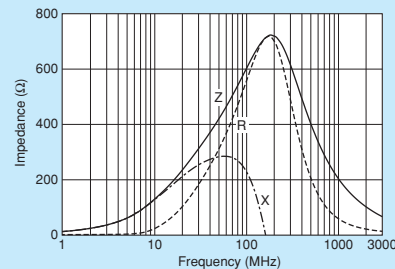

Note • Please read rating and CAUTION (for storage, operating, rating, soldering, mounting and handling) in this catalog to prevent smoking and/or burning, etc.
 • This catalog has only typical specifications. Therefore, please approve our product specifications or transact the approval sheet for product specifications before ordering.

Chip Ferrite Bead
SMD Type

Chip EMIFIL®
SMD Type

Chip Common Mode Choke Coil
SMD Type

Block Type EMIFIL®
SMD Type

EMI Suppression Filters
Lead Type

Microchip Transformer (Balun)
SMD Type

BLM15PG/BLM15PD Series 0402/1005 (inch/mm)

0402 size for power lines.

Appearance/Dimensions

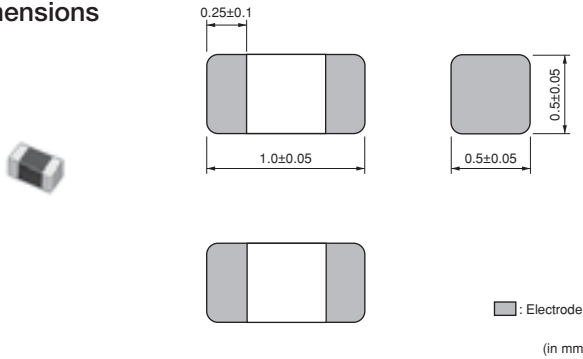

Packaging

Code	Packaging	Minimum Quantity
D	ø180mm Paper Taping	10000
J	ø330mm Paper Taping	50000
B	Packing in Bulk	1000



Equivalent Circuit

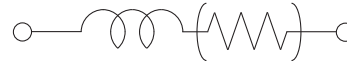

(Resistance element becomes dominant at high frequencies.)

Refer to pages from p.77 to p.80 for mounting information.

Rated Value (□: packaging code)

Part Number		Impedance (at 100MHz/20°C)	Rated Current	DC Resistance	Operating Temperature Range
For Infotainment	For Powertrain/Safety				
BLM15PG100SZ1□	—	10 Ω (Typ.)	1000mA	0.025 Ω max.	-55°C~+125°C
BLM15PD300SZ1□	—	30 Ω ±25%	2200mA	0.035 Ω max.	-55°C~+125°C
BLM15PD600SZ1□	—	60 Ω ±25%	1700mA	0.06 Ω max.	-55°C~+125°C
BLM15PD800SZ1□	—	80 Ω ±25%	1500mA	0.07 Ω max.	-55°C~+125°C
BLM15PD121SZ1□	—	120 Ω ±25%	1300mA	0.09 Ω max.	-55°C~+125°C

Number of Circuits: 1

Impedance-Frequency Characteristics (Main Items)

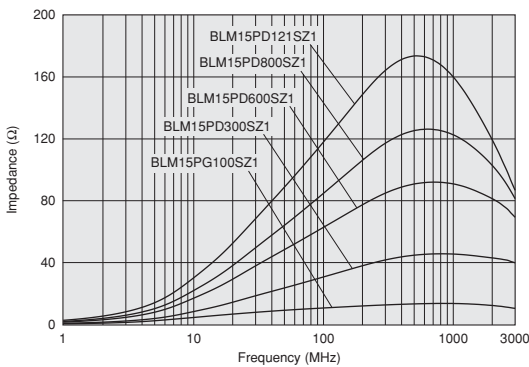

Derating of Rated Current

In operating temperature exceeding +85°C, derating of current is necessary for BLM15PD series.

Please apply the derating curve shown in chart according to the operating temperature.

Derating of Rated Current

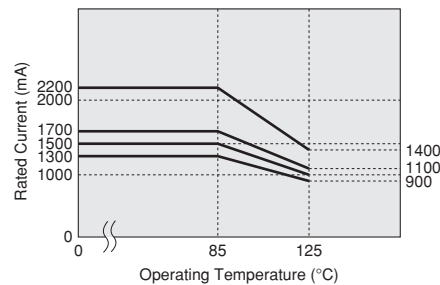

Continued on the following page.

Note • Please read rating and CAUTION (for storage, operating, rating, soldering, mounting and handling) in this catalog to prevent smoking and/or burning, etc.
• This catalog has only typical specifications. Therefore, please approve our product specifications or transact the approval sheet for product specifications before ordering.

■ Impedance-Frequency Characteristics

BLM15PG100SZ1

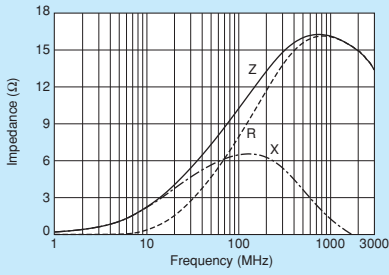

BLM15PD300SZ1

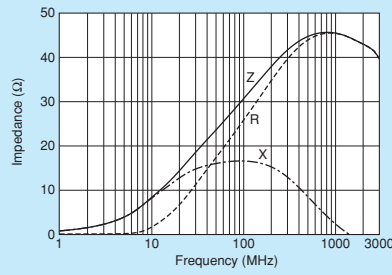

BLM15PD600SZ1

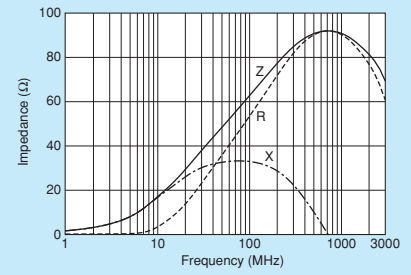

BLM15PD800SZ1

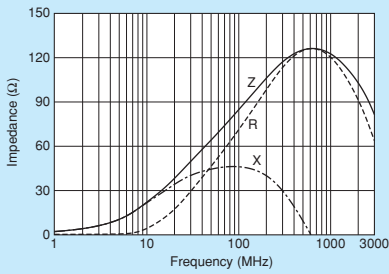

BLM15PD121SZ1

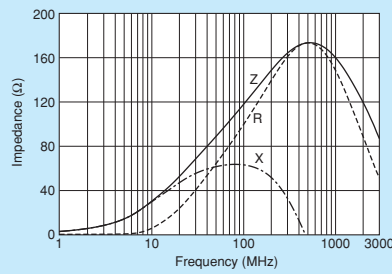

Chip Ferrite Bead
SMD Type

Chip EMIFIL®
SMD Type

Chip Common Mode Choke Coil
SMD Type

Block Type EMIFIL®
SMD Type

EMI Suppression Filters
Lead Type

Microchip Transformer (Balun)
SMD Type

⚠Note • Please read rating and ⚠CAUTION (for storage, operating, rating, soldering, mounting and handling) in this catalog to prevent smoking and/or burning, etc.
• This catalog has only typical specifications. Therefore, please approve our product specifications or transact the approval sheet for product specifications before ordering.

BLM15AX Series 0402/1005 (inch/mm)

High spec ferrite bead low DC resistance and wide impedance line up. Fit for both power lines and signal lines.

Appearance/Dimensions

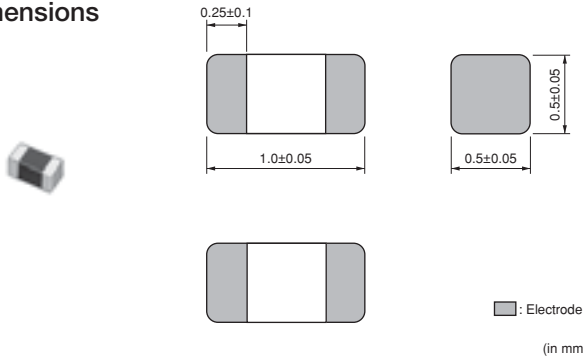

Packaging

Code	Packaging	Minimum Quantity
D	ø180mm Paper Taping	10000
J	ø330mm Paper Taping	50000
B	Packing in Bulk	1000



Equivalent Circuit

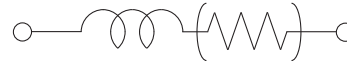

(Resistance element becomes dominant at high frequencies.)

Refer to pages from p.77 to p.80 for mounting information.

Rated Value (□: packaging code)

Part Number		Impedance (at 100MHz/20°C)	Rated Current	DC Resistance	Operating Temperature Range
For Infotainment	For Powertrain/Safety				
BLM15AX100SZ1□	—	10 Ω ±5Ω	1740mA	0.015Ω max.	-55°C~+125°C
BLM15AX300SZ1□	—	30Ω ±25%	1100mA	0.06Ω max.	-55°C~+125°C
BLM15AX700SZ1□	—	70Ω ±25%	780mA	0.1Ω max.	-55°C~+125°C
BLM15AX121SZ1□	—	120Ω ±25%	700mA	0.13Ω max.	-55°C~+125°C
BLM15AX221SZ1□	—	220Ω ±25%	600mA	0.18Ω max.	-55°C~+125°C
BLM15AX601SZ1□	—	600Ω ±25%	500mA	0.34Ω max.	-55°C~+125°C
BLM15AX102SZ1□	—	1000Ω ±25%	350mA	0.49Ω max.	-55°C~+125°C

Number of Circuits: 1

Impedance-Frequency Characteristics (Main Items)

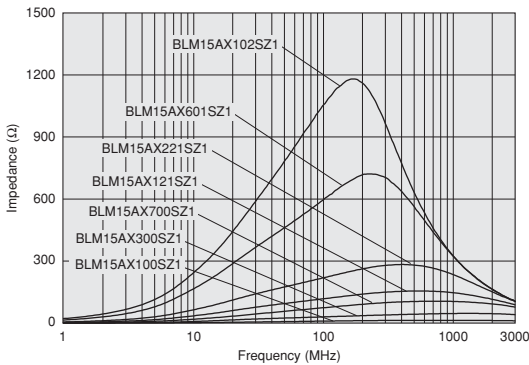

Impedance-Frequency Characteristics

BLM15AX100SZ1

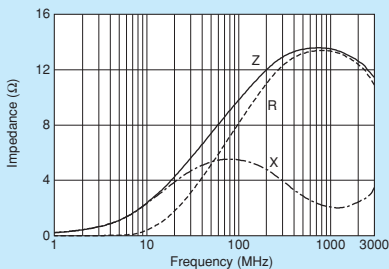

BLM15AX300SZ1

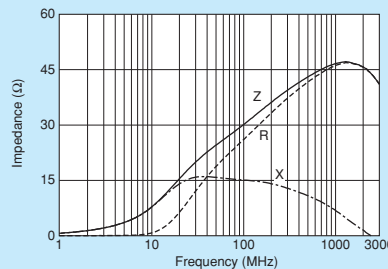

BLM15AX700SZ1

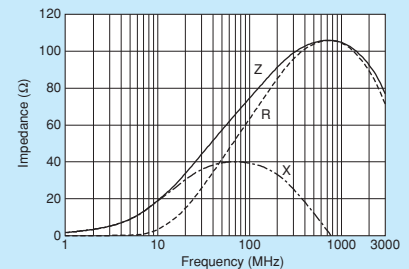

Continued on the following page.

Note • Please read rating and CAUTION (for storage, operating, rating, soldering, mounting and handling) in this catalog to prevent smoking and/or burning, etc.
• This catalog has only typical specifications. Therefore, please approve our product specifications or transact the approval sheet for product specifications before ordering.

■ Impedance-Frequency Characteristics

BLM15AX121SZ1

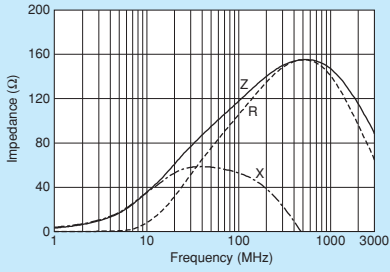

BLM15AX221SZ1

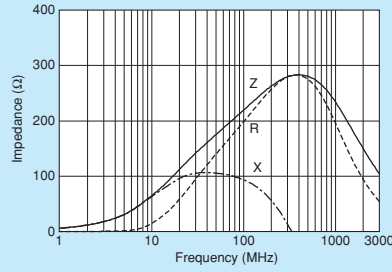

BLM15AX601SZ1

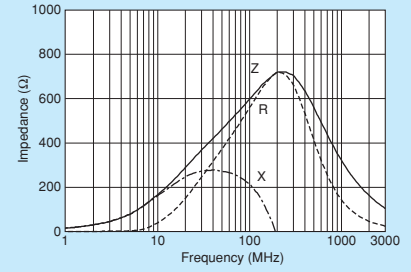

BLM15AX102SZ1

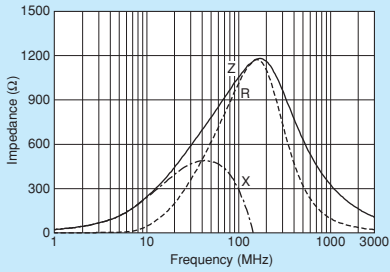

Chip Ferrite Bead
SMD Type

Chip EMIFIL®
SMD Type

Chip Common Mode Choke Coil
SMD Type

Block Type EMIFIL®
SMD Type

EMI Suppression Filters
Lead Type

Microchip Transformer (Balun)
SMD Type

⚠Note • Please read rating and ⚠CAUTION (for storage, operating, rating, soldering, mounting and handling) in this catalog to prevent smoking and/or burning, etc.
• This catalog has only typical specifications. Therefore, please approve our product specifications or transact the approval sheet for product specifications before ordering.

BLM15AG Series 0402/1005 (inch/mm)

0402 size for general signal lines.

■ Appearance/Dimensions

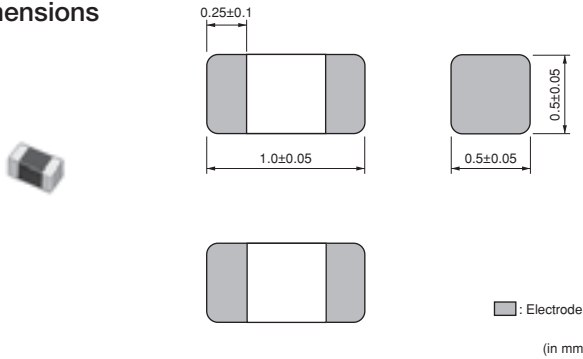

■ Packaging

Code	Packaging	Minimum Quantity
D	ø180mm Paper Taping	10000
J	ø330mm Paper Taping	50000
B	Packing in Bulk	1000



■ Equivalent Circuit

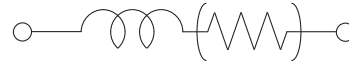

(Resistance element becomes dominant at high frequencies.)

Refer to pages from p.77 to p.80 for mounting information.

■ Rated Value (□: packaging code)

Part Number		Impedance (at 100MHz/20°C)	Rated Current	DC Resistance	Operating Temperature Range
For Infotainment	For Powertrain/Safety				
BLM15AG100SZ1□	BLM15AG100SH1□	10Ω (Typ.)	1000mA	0.025Ω max./0.05Ω max.	-55°C~+125°C
BLM15AG700SZ1□	BLM15AG700SH1□	70Ω (Typ.)	600mA/500mA	0.15Ω max.	-55°C~+125°C
BLM15AG121SZ1□	BLM15AG121SH1□	120Ω ±25%	550mA/500mA	0.19Ω max./0.25Ω max.	-55°C~+125°C
BLM15AG221SZ1□	BLM15AG221SH1□	220Ω ±25%	450mA/300mA	0.29Ω max./0.35Ω max.	-55°C~+125°C
BLM15AG601SZ1□	BLM15AG601SH1□	600Ω ±25%	300mA	0.52Ω max./0.6Ω max.	-55°C~+125°C
BLM15AG102SZ1□	BLM15AG102SH1□	1000Ω ±25%	300mA/200mA	0.65Ω max./1.0Ω max.	-55°C~+125°C

Number of Circuits: 1

■ Impedance-Frequency Characteristics (Main Items)

BLM15AG_SZ Series

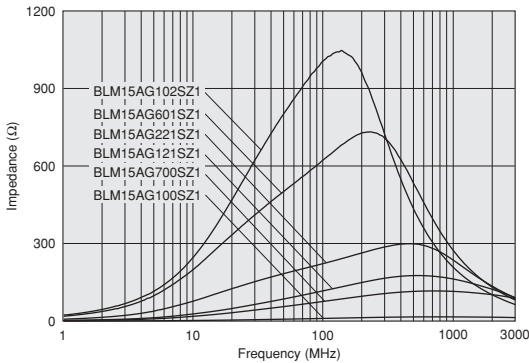

BLM15AG_SH Series

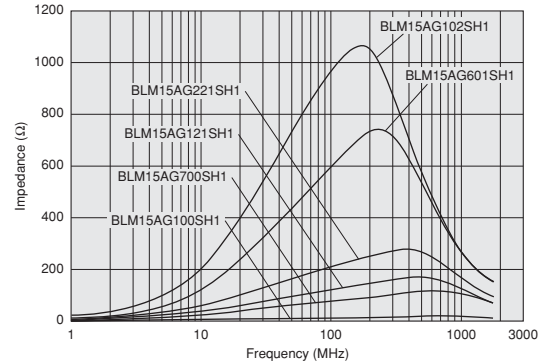

■ Impedance-Frequency Characteristics

BLM15AG100SZ1

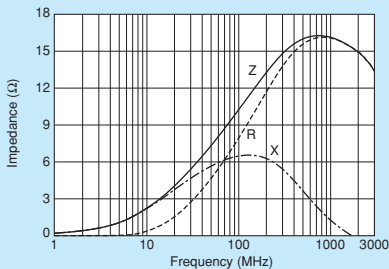

BLM15AG100SH1

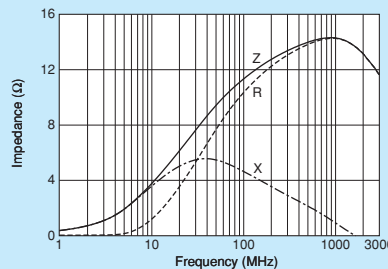

BLM15AG700SZ1

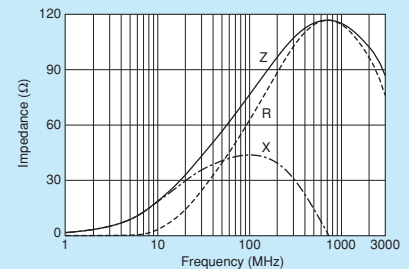

Continued on the following page.

△Note • Please read rating and CAUTION (for storage, operating, rating, soldering, mounting and handling) in this catalog to prevent smoking and/or burning, etc.
• This catalog has only typical specifications. Therefore, please approve our product specifications or transact the approval sheet for product specifications before ordering.

■ Impedance-Frequency Characteristics

BLM15AG700SH1

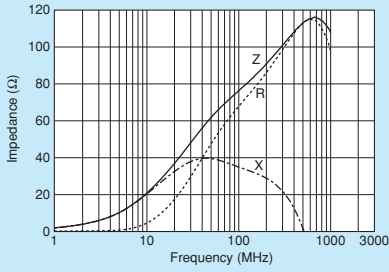

BLM15AG121SZ1

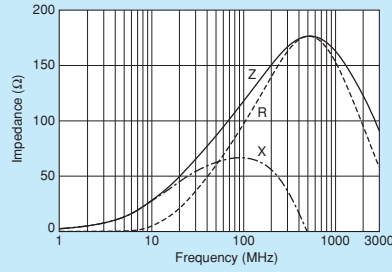

BLM15AG121SH1

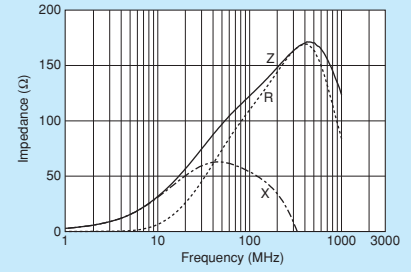

BLM15AG221SZ1

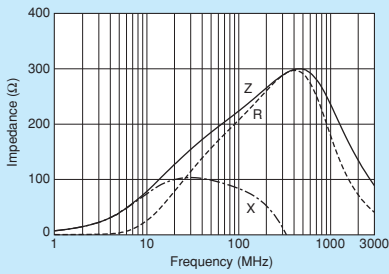

BLM15AG221SH1

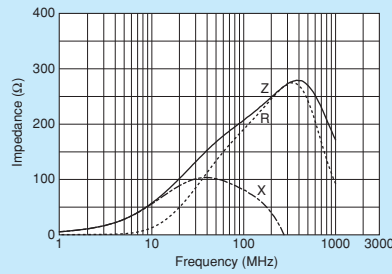

BLM15AG601SZ1/BLM15AG601SH1

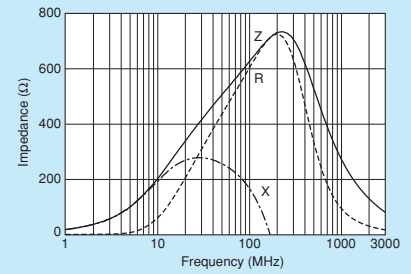

BLM15AG102SZ1/BLM15AG102SH1

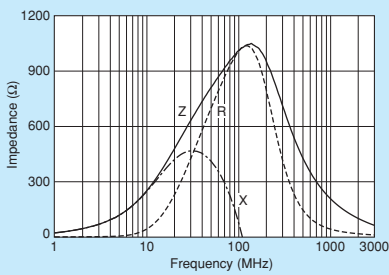

Chip Ferrite Bead
SMD Type

Chip EMIFIL®
SMD Type

Chip Common Mode Choke Coil
SMD Type

Block Type EMIFIL®
SMD Type

EMI Suppression Filters
Lead Type

Microchip Transformer (Balun)
SMD Type

⚠Note • Please read rating and ⚠CAUTION (for storage, operating, rating, soldering, mounting and handling) in this catalog to prevent smoking and/or burning, etc.
• This catalog has only typical specifications. Therefore, please approve our product specifications or transact the approval sheet for product specifications before ordering.

BLM15BX Series 0402/1005 (inch/mm)

0402 size for high speed signal lines, low DC resistance.

■ Appearance/Dimensions

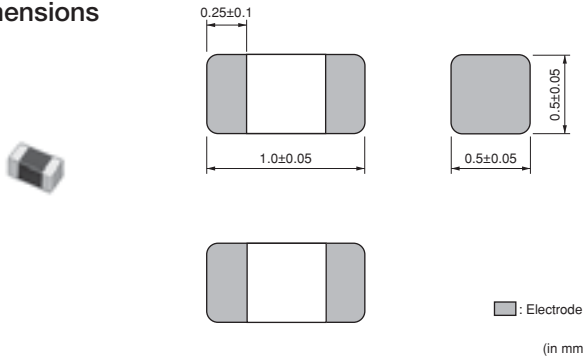

■ Packaging

Code	Packaging	Minimum Quantity
D	ø180mm Paper Taping	10000
J	ø330mm Paper Taping	50000
B	Packing in Bulk	1000



■ Equivalent Circuit

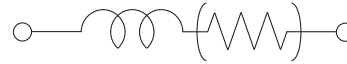

(Resistance element becomes dominant at high frequencies.)

Refer to pages from p.77 to p.80 for mounting information.

■ Rated Value (□: packaging code)

Part Number		Impedance (at 100MHz/20°C)	Rated Current	DC Resistance	Operating Temperature Range
For Infotainment	For Powertrain/Safety				
BLM15BX750SZ1□	—	75Ω ±25%	600mA	0.15Ω max.	-55°C~+125°C
BLM15BX121SZ1□	—	120Ω ±25%	600mA	0.17Ω max.	-55°C~+125°C
BLM15BX221SZ1□	—	220Ω ±25%	450mA	0.27Ω max.	-55°C~+125°C
BLM15BX471SZ1□	—	470Ω ±25%	350mA	0.41Ω max.	-55°C~+125°C
BLM15BX601SZ1□	—	600Ω ±25%	350mA	0.46Ω max.	-55°C~+125°C
BLM15BX102SZ1□	—	1000Ω ±25%	300mA	0.65Ω max.	-55°C~+125°C
BLM15BX182SZ1□	—	1800Ω ±25%	250mA	0.90Ω max.	-55°C~+125°C

Number of Circuits: 1

■ Impedance-Frequency Characteristics (Main Items)

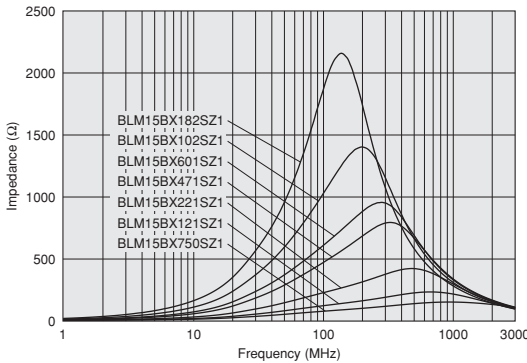

■ Impedance-Frequency Characteristics

BLM15BX750SZ1

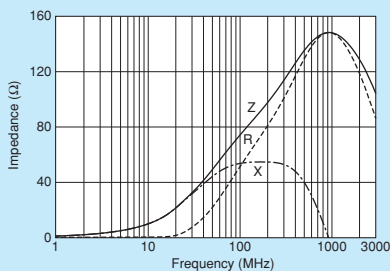

BLM15BX121SZ1

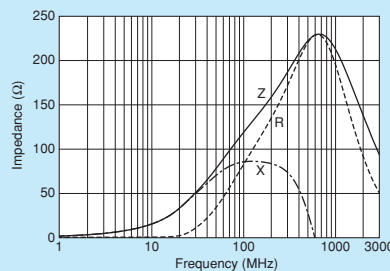

BLM15BX221SZ1

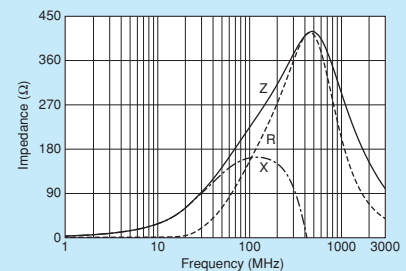

Continued on the following page.

△Note • Please read rating and △CAUTION (for storage, operating, rating, soldering, mounting and handling) in this catalog to prevent smoking and/or burning, etc.
• This catalog has only typical specifications. Therefore, please approve our product specifications or transact the approval sheet for product specifications before ordering.

■ Impedance-Frequency Characteristics

BLM15BX471SZ1

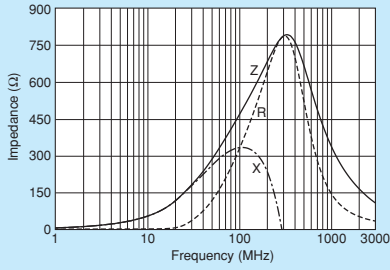

BLM15BX601SZ1

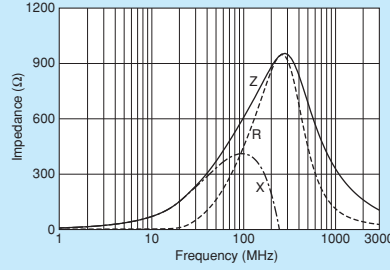

BLM15BX102SZ1

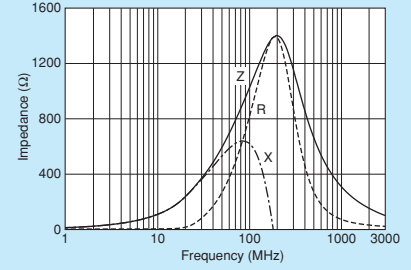

BLM15BX182SZ1

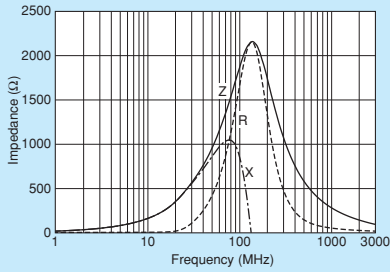

Chip Ferrite Bead
SMD Type

Chip EMIFIL®
SMD Type

Chip Common Mode Choke Coil
SMD Type

Block Type EMIFIL®
SMD Type

EMI Suppression Filters
Lead Type

Microchip Transformer (Balun)
SMD Type

⚠Note • Please read rating and ⚠CAUTION (for storage, operating, rating, soldering, mounting and handling) in this catalog to prevent smoking and/or burning, etc.
• This catalog has only typical specifications. Therefore, please approve our product specifications or transact the approval sheet for product specifications before ordering.

BLM15B Series 0402/1005 (inch/mm)

0402 size for high speed signal lines.

■ Appearance/ Dimensions

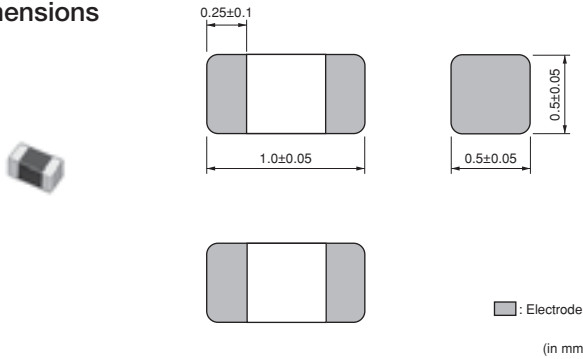

■ Packaging

Code	Packaging	Minimum Quantity
D	ø180mm Paper Taping	10000
J	ø330mm Paper Taping	50000
B	Packing in Bulk	1000



■ Equivalent Circuit

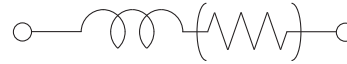

(Resistance element becomes dominant at high frequencies.)

Refer to pages from p.77 to p.80 for mounting information.

■ Rated Value (□: packaging code)

Part Number		Impedance (at 100MHz/20°C)	Rated Current	DC Resistance	Operating Temperature Range
For Infotainment	For Powertrain/Safety				
BLM15BD750SZ1□	—	75 Ω ±25%	300mA	0.20 Ω max.	-55°C~+125°C
BLM15BD121SZ1□	—	120 Ω ±25%	300mA	0.30 Ω max.	-55°C~+125°C
BLM15BD221SZ1□	—	220 Ω ±25%	300mA	0.40 Ω max.	-55°C~+125°C
BLM15BD471SZ1□	BLM15BD471SH1□	470 Ω ±25%	200mA	0.60 Ω max.	-55°C~+125°C
BLM15BD601SZ1□	BLM15BD601SH1□	600 Ω ±25%	200mA	0.65 Ω max.	-55°C~+125°C
BLM15BD102SZ1□	BLM15BD102SH1□	1000 Ω ±25%	200mA	0.90 Ω max.	-55°C~+125°C
BLM15BD182SZ1□	BLM15BD182SH1□	1800 Ω ±25%	100mA/200mA	1.40 Ω max.	-55°C~+125°C
BLM15BB050SZ1□	BLM15BB050SH1□	5 Ω ±25%	500mA	0.08 Ω max.	-55°C~+125°C
BLM15BB100SZ1□	BLM15BB100SH1□	10 Ω ±25%	300mA	0.10 Ω max.	-55°C~+125°C
BLM15BB220SZ1□	BLM15BB220SH1□	22 Ω ±25%	300mA	0.20 Ω max.	-55°C~+125°C
BLM15BB470SZ1□	BLM15BB470SH1□	47 Ω ±25%	300mA	0.35 Ω max.	-55°C~+125°C
BLM15BB750SZ1□	BLM15BB750SH1□	75 Ω ±25%	300mA	0.40 Ω max.	-55°C~+125°C
BLM15BB121SZ1□	BLM15BB121SH1□	120 Ω ±25%	300mA	0.55 Ω max.	-55°C~+125°C
BLM15BB221SZ1□	BLM15BB221SH1□	220 Ω ±25%	200mA	0.80 Ω max.	-55°C~+125°C
BLM15BC121SZ1□	—	120 Ω ±25%	350mA	0.45 Ω max.	-55°C~+125°C
BLM15BC241SZ1□	—	240 Ω ±25%	250mA	0.70 Ω max.	-55°C~+125°C
BLM15BA050SZ1□	—	5 Ω ±25%	300mA	0.10 Ω max.	-55°C~+125°C
BLM15BA100SZ1□	—	10 Ω ±25%	300mA	0.20 Ω max.	-55°C~+125°C
BLM15BA220SZ1□	—	22 Ω ±25%	300mA	0.30 Ω max.	-55°C~+125°C
BLM15BA330SZ1□	—	33 Ω ±25%	300mA	0.40 Ω max.	-55°C~+125°C
BLM15BA470SZ1□	—	47 Ω ±25%	200mA	0.60 Ω max.	-55°C~+125°C
BLM15BA750SZ1□	—	75 Ω ±25%	200mA	0.80 Ω max.	-55°C~+125°C

Number of Circuits: 1

Continued on the following page. ↗

△Note • Please read rating and △CAUTION (for storage, operating, rating, soldering, mounting and handling) in this catalog to prevent smoking and/or burning, etc.
• This catalog has only typical specifications. Therefore, please approve our product specifications or transact the approval sheet for product specifications before ordering.

Chip Ferrite Bead
SMD Type

Chip EMIFIL®
SMD Type

Chip Common Mode Choke Coil
SMD Type

Block Type EMIFIL®
SMD Type

EMI Suppression Filters
Lead Type

Microchip Transformer (Balun)
SMD Type

■ Impedance-Frequency Characteristics (Main Items)

BLM15BD_SZ Series

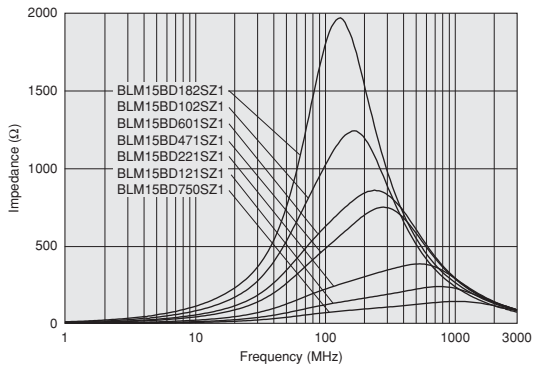

BLM15BD_SH Series

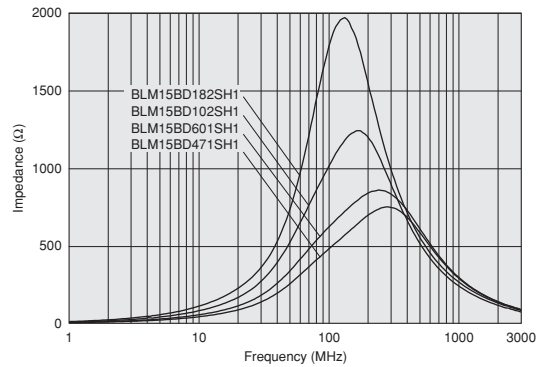

BLM15BB_SZ Series

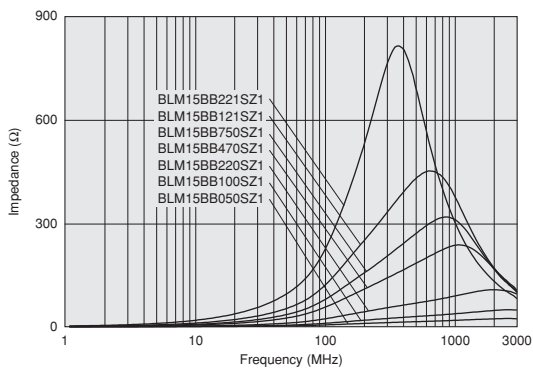

BLM15BB_SH Series

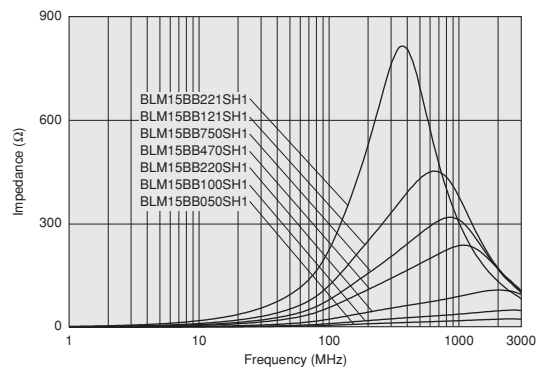

BLM15BC_SZ Series

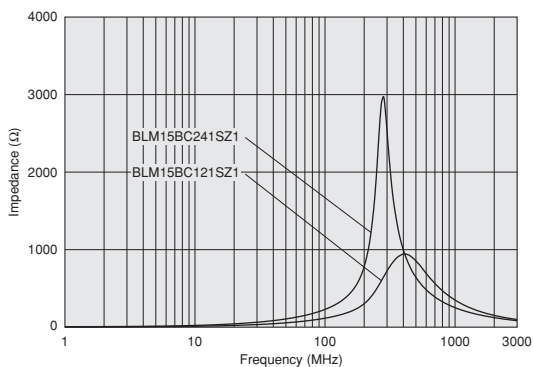

BLM15BA_SZ Series

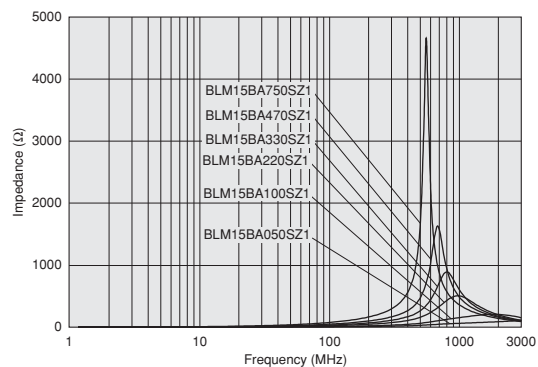

Continued on the following page.

⚠Note • Please read rating and ⚠CAUTION (for storage, operating, rating, soldering, mounting and handling) in this catalog to prevent smoking and/or burning, etc.
• This catalog has only typical specifications. Therefore, please approve our product specifications or transact the approval sheet for product specifications before ordering.

Impedance-Frequency Characteristics

BLM15BD750SZ1

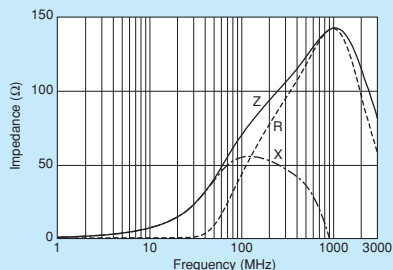

BLM15BD121SZ1

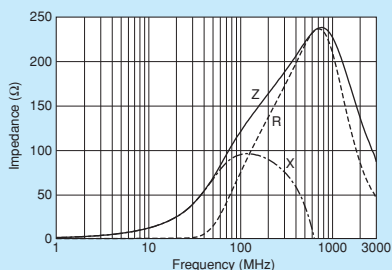

BLM15BD221SZ1

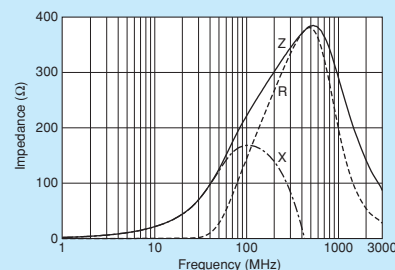

BLM15BD471SZ1/BLM15BD471SH1

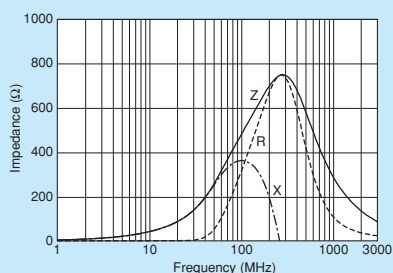

BLM15BD601SZ1/BLM15BD601SH1

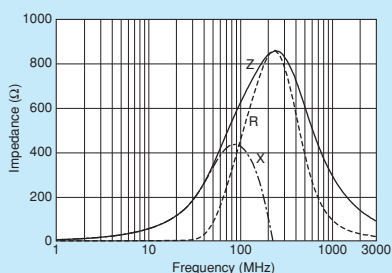

BLM15BD102SZ1/BLM15BD102SH1

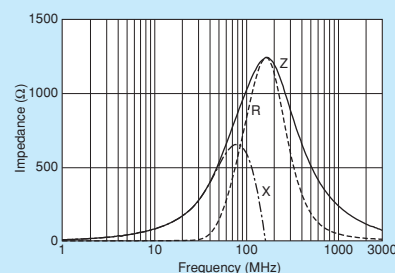

BLM15BD182SZ1/BLM15BD182SH1

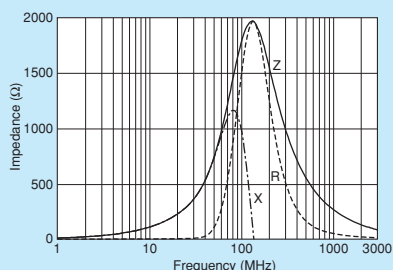

BLM15BB050SZ1/BLM15BB050SH1

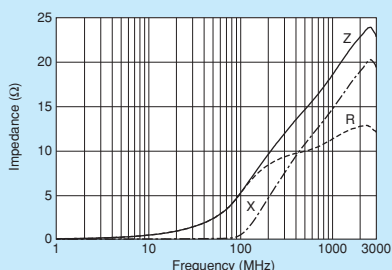

BLM15BB100SZ1/BLM15BB100SH1

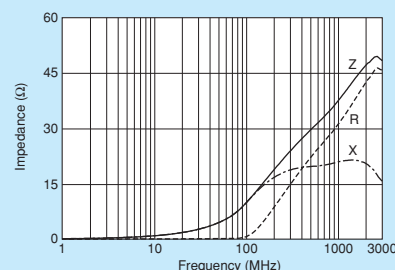

BLM15BB220SZ1/BLM15BB220SH1

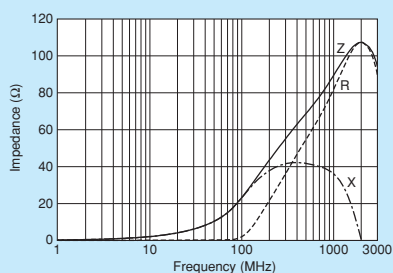

BLM15BB470SZ1/BLM15BB470SH1

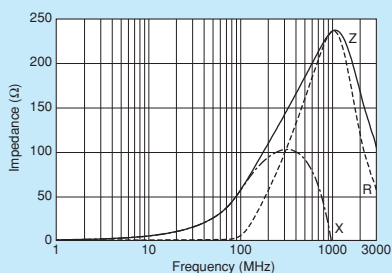

BLM15BB750SZ1/BLM15BB750SH1

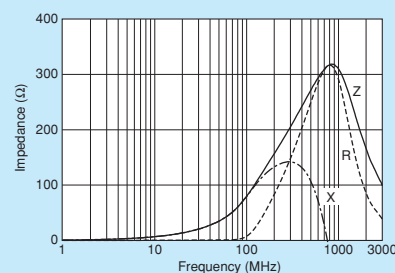

BLM15BB121SZ1/BLM15BB121SH1

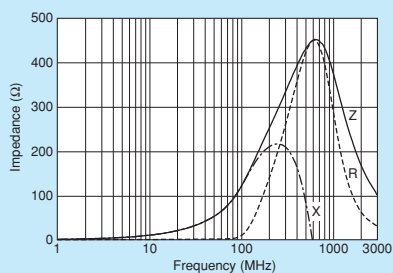

BLM15BB221SZ1/BLM15BB221SH1

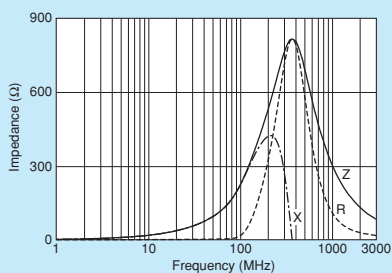

BLM15BC121SZ1

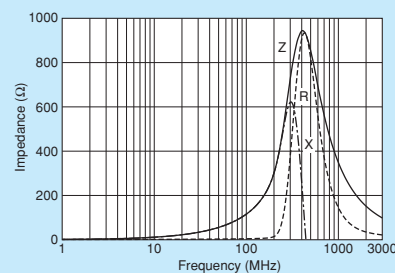

Continued on the following page.

Note • Please read rating and **CAUTION** (for storage, operating, rating, soldering, mounting and handling) in this catalog to prevent smoking and/or burning, etc.
 • This catalog has only typical specifications. Therefore, please approve our product specifications or transact the approval sheet for product specifications before ordering.

SMD Type
Chip Ferrite Bead
SMD Type
Chip EMIFIL®
SMD Type
SMD Type
Chip Common Mode Choke Coil
SMD Type
Block Type EMIFIL®
Lead Type
EMI Suppression Filters
SMD Type
Microchip Transformer (Balun)

Impedance-Frequency Characteristics

BLM15BC241SZ1

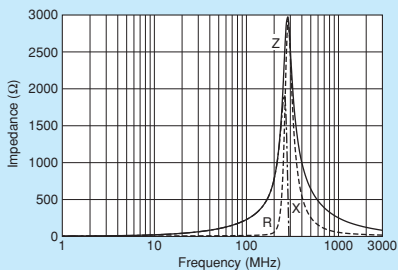

BLM15BA050SZ1

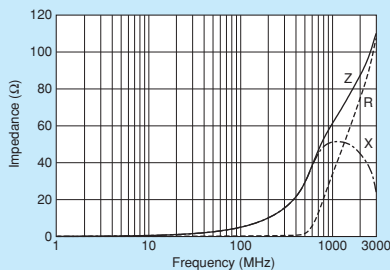

BLM15BA100SZ1

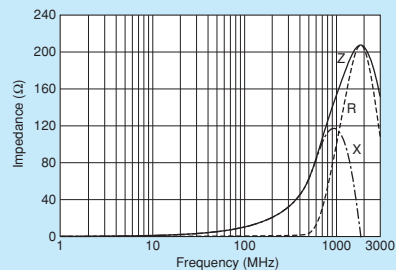

BLM15BA220SZ1

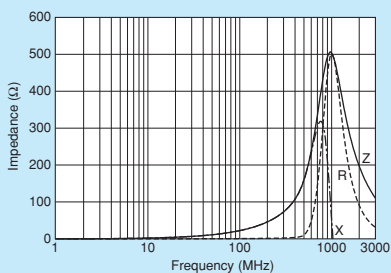

BLM15BA330SZ1

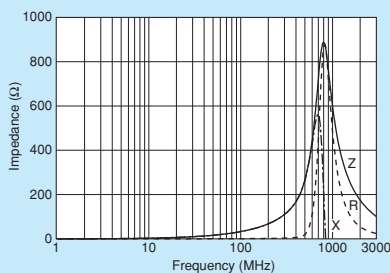

BLM15BA470SZ1

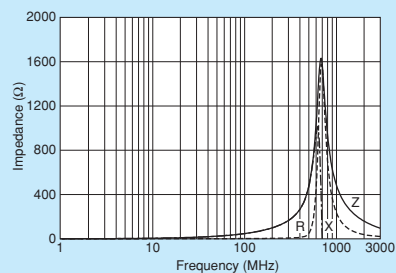

BLM15BA750SZ1

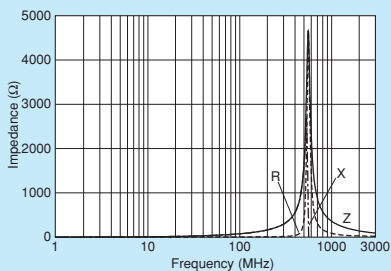

Chip Ferrite Bead
SMD Type

Chip EMIFIL®
SMD Type

Chip Common Mode Choke Coil
SMD Type

Block Type EMIFIL®
SMD Type

EMI Suppression Filters
Lead Type

Microchip Transformer (Balun)
SMD Type

Note • Please read rating and CAUTION (for storage, operating, rating, soldering, mounting and handling) in this catalog to prevent smoking and/or burning, etc.
• This catalog has only typical specifications. Therefore, please approve our product specifications or transact the approval sheet for product specifications before ordering.

BLM18PG Series 0603/1608 (inch/mm)

0603 size for power lines.

Appearance/Dimensions

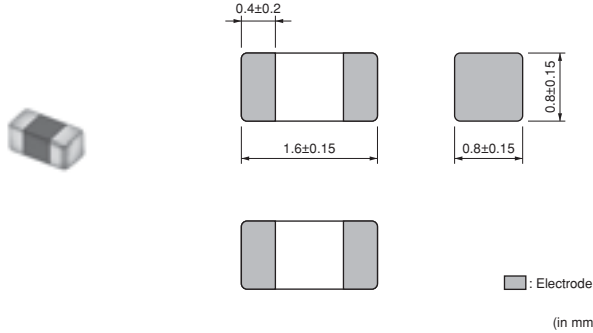

Packaging

Code	Packaging	Minimum Quantity
D	ø180mm Paper Taping	4000
J	ø330mm Paper Taping	10000
B	Packing in Bulk	1000

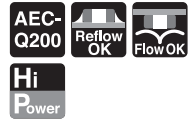

Equivalent Circuit

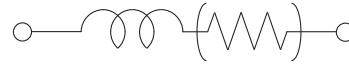

(Resistance element becomes dominant at high frequencies.)

Refer to pages from p.77 to p.80 for mounting information.

Rated Value (□: packaging code)

Part Number		Impedance (at 100MHz/20°C)	Rated Current	DC Resistance	Operating Temperature Range
For Infotainment	For Powertrain/Safety				
BLM18PG300SZ1□	BLM18PG300SH1□	30 Ω (Typ.)	1000mA	0.05 Ω max.	-55°C~+125°C
BLM18PG330SZ1□	BLM18PG330SH1□	33 Ω ±25%	3000mA	0.025 Ω max.	-55°C~+125°C
BLM18PG600SZ1□	BLM18PG600SH1□	60 Ω (Typ.)	500mA	0.10 Ω max.	-55°C~+125°C
BLM18PG121SZ1□	BLM18PG121SH1□	120 Ω ±25%	2000mA	0.05 Ω max.	-55°C~+125°C
BLM18PG181SZ1□	BLM18PG181SH1□	180 Ω ±25%	1500mA	0.09 Ω max.	-55°C~+125°C
BLM18PG221SZ1□	BLM18PG221SH1□	220 Ω ±25%	1400mA	0.10 Ω max.	-55°C~+125°C
BLM18PG331SZ1□	BLM18PG331SH1□	330 Ω ±25%	1200mA	0.15 Ω max.	-55°C~+125°C
BLM18PG471SZ1□	BLM18PG471SH1□	470 Ω ±25%	1000mA	0.20 Ω max.	-55°C~+125°C

Number of Circuits: 1

Impedance-Frequency Characteristics (Main Items)

BLM18PG_SZ Series

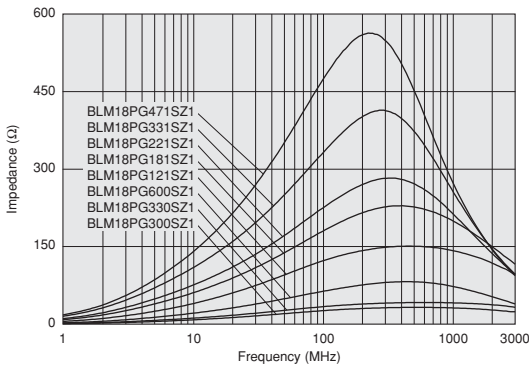

BLM18PG_SH Series

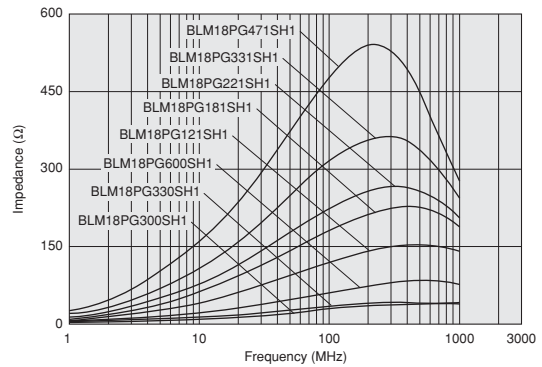

Continued on the following page. ↗

⚠Note • Please read rating and ⚠CAUTION (for storage, operating, rating, soldering, mounting and handling) in this catalog to prevent smoking and/or burning, etc.
• This catalog has only typical specifications. Therefore, please approve our product specifications or transact the approval sheet for product specifications before ordering.

Derating of Rated Current

In operating temperature exceeding +85°C, derating of current is necessary for BLM18PG series.

Please apply the derating curve shown in chart according to the operating temperature.

Derating of Rated Current

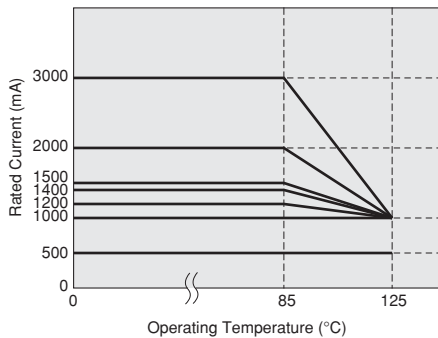

Impedance-Frequency Characteristics

BLM18PG300SZ1/BLM18PG300SH1

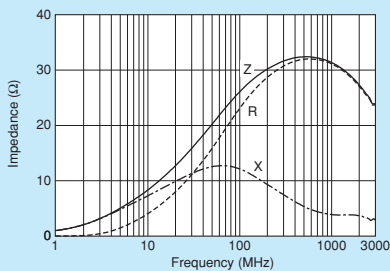

BLM18PG330SZ1/BLM18PG330SH1

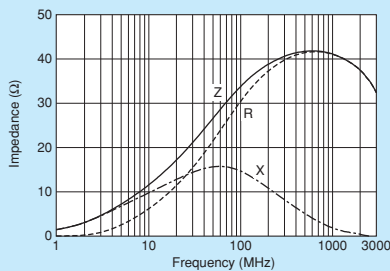

BLM18PG600SZ1/BLM18PG600SH1

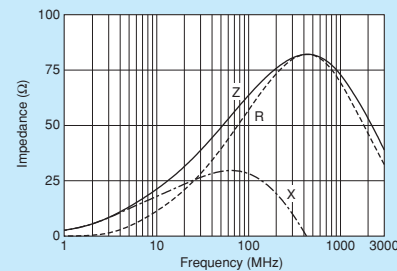

BLM18PG121SZ1/BLM18PG121SH1

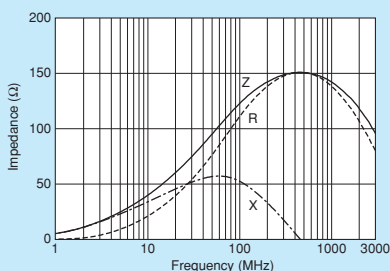

BLM18PG181SZ1/BLM18PG181SH1

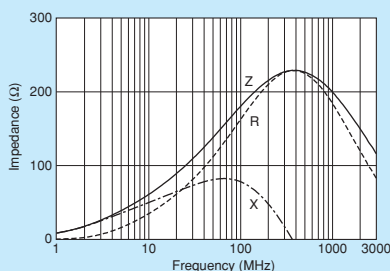

BLM18PG221SZ1/BLM18PG221SH1

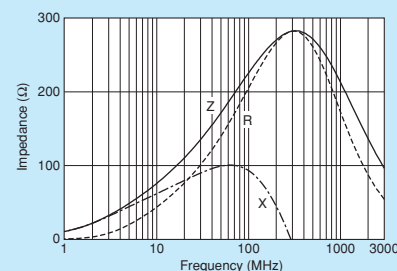

BLM18PG331SZ1/BLM18PG331SH1

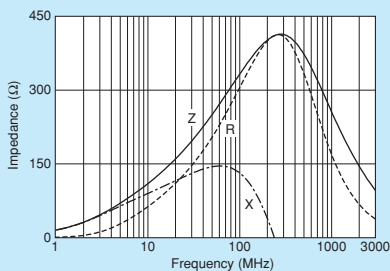

BLM18PG471SZ1/BLM18PG471SH1

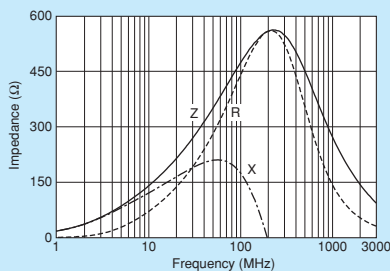

Note • Please read rating and CAUTION (for storage, operating, rating, soldering, mounting and handling) in this catalog to prevent smoking and/or burning, etc.
 • This catalog has only typical specifications. Therefore, please approve our product specifications or transact the approval sheet for product specifications before ordering.

Chip Ferrite Bead SMD Type
 Chip EMIFIL® SMD Type
 Chip Common Mode Choke Coil SMD Type
 Block Type EMIFIL® SMD Type
 EMI Suppression Filters Lead Type
 Microchip Transformer (Balun) SMD Type

BLM18KG Series 0603/1608 (inch/mm)

6A max., high performance type for power lines up to 600ohm.

■ Appearance/Dimensions

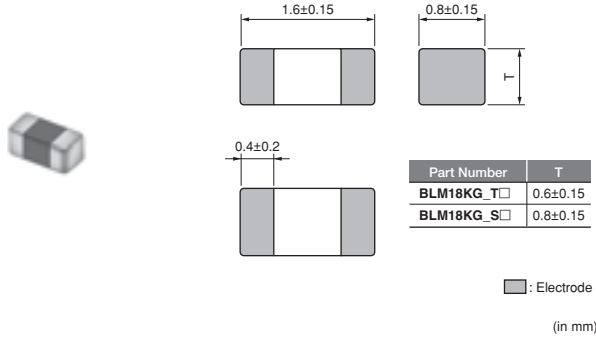

■ Packaging

Code	Packaging	Minimum Quantity
D	ø180mm Paper Taping	4000
J	ø330mm Paper Taping	10000
B	Packing in Bulk	1000

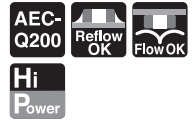

■ Equivalent Circuit

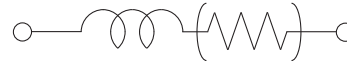

(Resistance element becomes dominant at high frequencies.)

Refer to pages from p.77 to p.80 for mounting information.

■ Rated Value (□: packaging code)

Part Number		Impedance (at 100MHz/20°C)	Rated Current	DC Resistance	Operating Temperature Range
For Infotainment	For Powertrain/Safety				
BLM18KG260TZ1□	—	26Ω ±25%	6000mA	0.007Ω max.	-55°C~+125°C
BLM18KG300TZ1□	—	30Ω ±25%	5000mA	0.010Ω max.	-55°C~+125°C
BLM18KG700TZ1□	—	70Ω ±25%	3500mA	0.022Ω max.	-55°C~+125°C
BLM18KG101TZ1□	—	100Ω ±25%	3000mA	0.030Ω max.	-55°C~+125°C
BLM18KG121TZ1□	—	120Ω ±25%	3000mA	0.030Ω max.	-55°C~+125°C
BLM18KG221SZ1□	—	220Ω ±25%	2200mA	0.050Ω max.	-55°C~+125°C
BLM18KG331SZ1□	—	330Ω ±25%	1700mA	0.080Ω max.	-55°C~+125°C
BLM18KG471SZ1□	—	470Ω ±25%	1500mA	0.130Ω max.	-55°C~+125°C
BLM18KG601SZ1□	—	600Ω ±25%	1300mA	0.150Ω max.	-55°C~+125°C

Number of Circuits: 1

■ Impedance-Frequency Characteristics (Main Items)

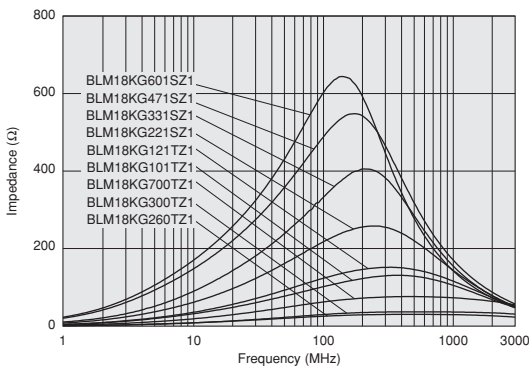

Continued on the following page. ↗

△Note • Please read rating and △CAUTION (for storage, operating, rating, soldering, mounting and handling) in this catalog to prevent smoking and/or burning, etc.
• This catalog has only typical specifications. Therefore, please approve our product specifications or transact the approval sheet for product specifications before ordering.

SMD Type Chip Ferrite Bead
SMD Type Chip EMIFIL®
SMD Type Chip Common Mode Choke Coil
SMD Type Block Type EMIFIL®
Lead Type EMI Suppression Filters
SMD Type Microchip Transformer (Balun)

Derating of Rated Current

In operating temperature exceeding +85°C, derating of current is necessary for BLM18KG series.

Please apply the derating curve shown in chart according to the operating temperature.

Derating of Rated Current

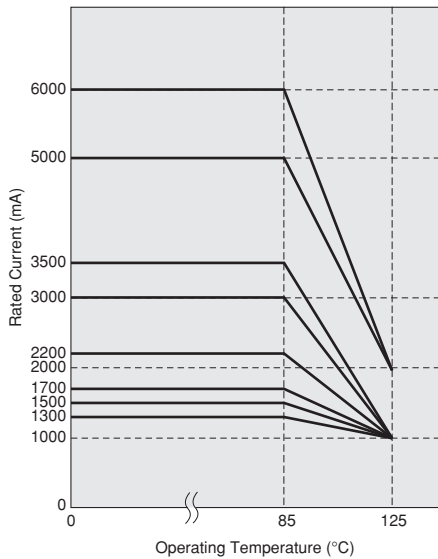

Impedance-Frequency Characteristics

BLM18KG260TZ1

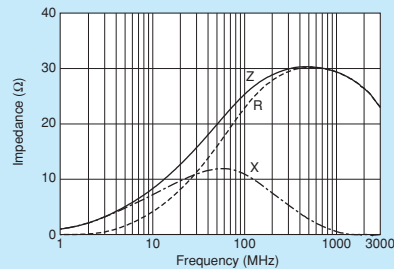

BLM18KG300TZ1

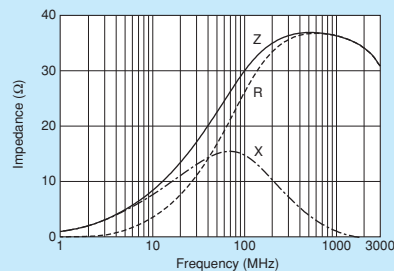

BLM18KG700TZ1

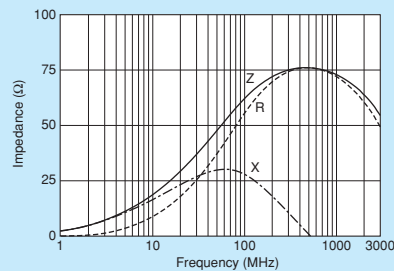

BLM18KG101TZ1

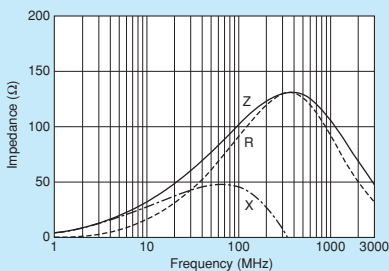

BLM18KG121TZ1

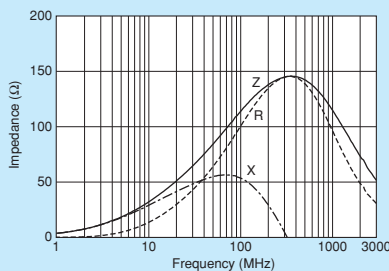

BLM18KG221SZ1

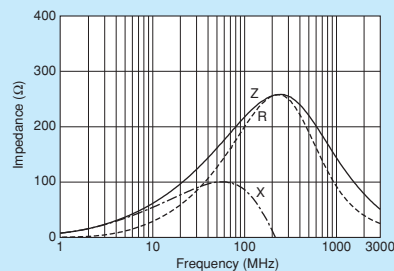

BLM18KG331SZ1

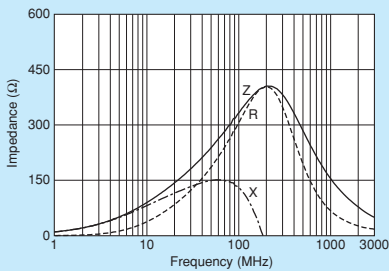

BLM18KG471SZ1

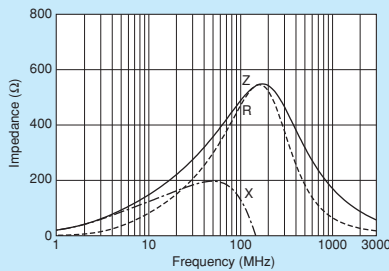

BLM18KG601SZ1

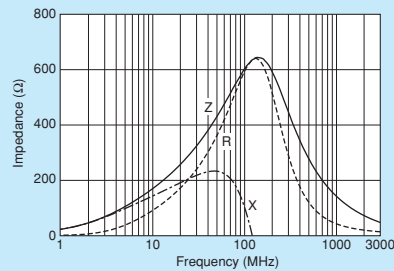

⚠Note • Please read rating and ⚠CAUTION (for storage, operating, rating, soldering, mounting and handling) in this catalog to prevent smoking and/or burning, etc.
• This catalog has only typical specifications. Therefore, please approve our product specifications or transact the approval sheet for product specifications before ordering.

BLM18SG Series 0603/1608 (inch/mm)

6A max., high performance type for power lines.

Appearance/Dimensions

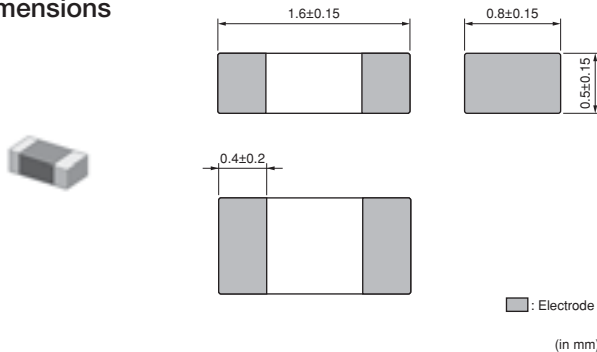

Packaging

Code	Packaging	Minimum Quantity
D	ø180mm Paper Taping	10000
J	ø330mm Paper Taping	30000
B	Packing in Bulk	1000

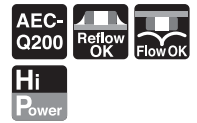

Equivalent Circuit



(Resistance element becomes dominant at high frequencies.)

Refer to pages from p.77 to p.80 for mounting information.

Rated Value (□: packaging code)

Part Number		Impedance (at 100MHz/20°C)	Rated Current	DC Resistance	Operating Temperature Range
For Infotainment	For Powertrain/Safety				
BLM18SG260TZ1□	—	26Ω ±25%	6000mA	0.007Ω max.	-55°C~+125°C
BLM18SG700TZ1□	—	70Ω ±25%	4000mA	0.020Ω max.	-55°C~+125°C
BLM18SG121TZ1□	—	120Ω ±25%	3000mA	0.025Ω max.	-55°C~+125°C
BLM18SG221TZ1□	—	220Ω ±25%	2500mA	0.040Ω max.	-55°C~+125°C
BLM18SG331TZ1□	—	330Ω ±25%	1500mA	0.070Ω max.	-55°C~+125°C

Number of Circuits: 1

Impedance-Frequency Characteristics (Main Items)

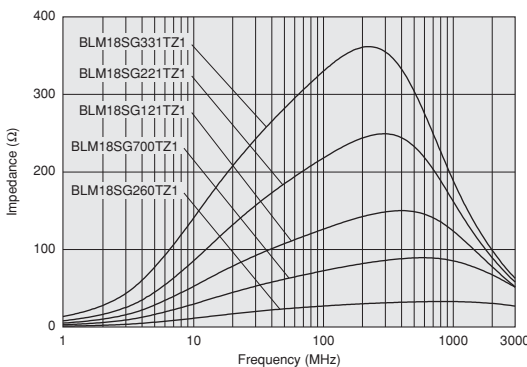

Derating of Rated Current

In operating temperature exceeding +85°C, derating of current is necessary for BLM18SG series.

Please apply the derating curve shown in chart according to the operating temperature.

Derating of Rated Current

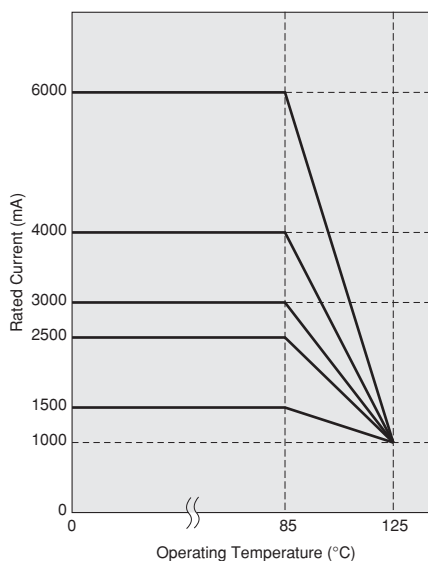

Continued on the following page.

Note • Please read rating and **CAUTION** (for storage, operating, rating, soldering, mounting and handling) in this catalog to prevent smoking and/or burning, etc.
• This catalog has only typical specifications. Therefore, please approve our product specifications or transact the approval sheet for product specifications before ordering.

SMD Type Chip Ferrite Bead
SMD Type Chip EMIFIL®
SMD Type Chip Common Mode Choke Coil
SMD Type Block Type EMIFIL®
Lead Type EMI Suppression Filters
SMD Type Microchip Transformer (Balun)

■ Impedance-Frequency Characteristics

BLM18SG260TZ1

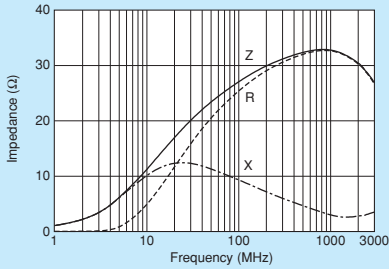

BLM18SG700TZ1

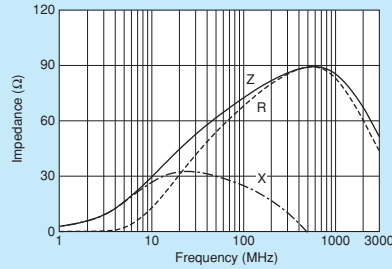

BLM18SG121TZ1

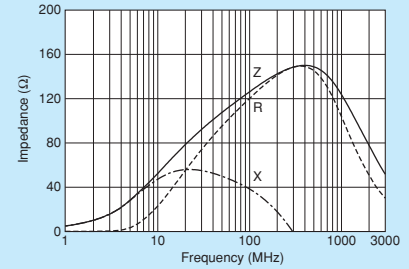

BLM18SG221TZ1

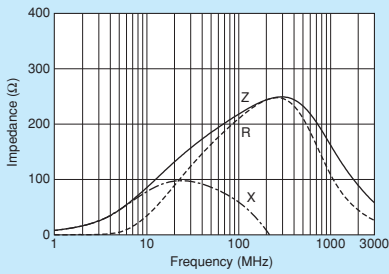

BLM18SG331TZ1

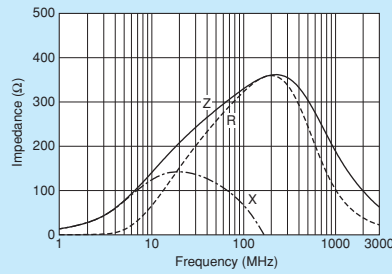

Chip Ferrite Bead
SMD Type

Chip EMIFIL®
SMD Type

Chip Common Mode Choke Coil
SMD Type

Block Type EMIFIL®
SMD Type

EMI Suppression Filters
Lead Type

Microchip Transformer (Balun)
SMD Type

⚠Note • Please read rating and ⚠CAUTION (for storage, operating, rating, soldering, mounting and handling) in this catalog to prevent smoking and/or burning, etc.
• This catalog has only typical specifications. Therefore, please approve our product specifications or transact the approval sheet for product specifications before ordering.

BLM18AG_S Series 0603/1608 (inch/mm)

0603 size for general signal lines.

■ Appearance/Dimensions

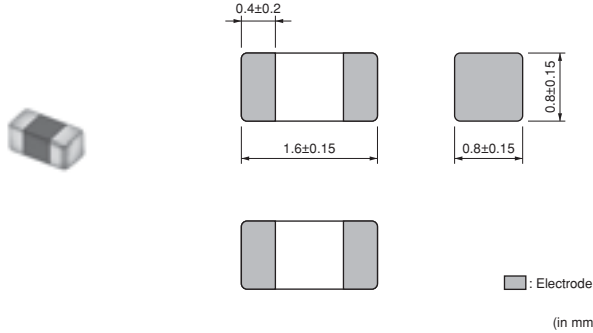

■ Packaging

Code	Packaging	Minimum Quantity
D	ø180mm Paper Taping	4000
J	ø330mm Paper Taping	10000
B	Packing in Bulk	1000



■ Equivalent Circuit

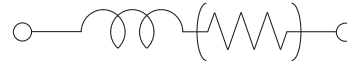

(Resistance element becomes dominant at high frequencies.)

Refer to pages from p.77 to p.80 for mounting information.

■ Rated Value (□: packaging code)

Part Number		Impedance (at 100MHz/20°C)	Rated Current	DC Resistance	Operating Temperature Range
For Infotainment	For Powertrain/Safety				
BLM18AG121SZ1□	BLM18AG121SH1□	120 Ω ±25%	500mA	0.18 Ω max.	-55°C ~ +125°C
BLM18AG151SZ1□	BLM18AG151SH1□	150 Ω ±25%	500mA	0.25 Ω max.	-55°C ~ +125°C
BLM18AG221SZ1□	BLM18AG221SH1□	220 Ω ±25%	500mA	0.25 Ω max.	-55°C ~ +125°C
BLM18AG331SZ1□	BLM18AG331SH1□	330 Ω ±25%	500mA	0.30 Ω max.	-55°C ~ +125°C
BLM18AG471SZ1□	BLM18AG471SH1□	470 Ω ±25%	500mA	0.35 Ω max.	-55°C ~ +125°C
BLM18AG601SZ1□	BLM18AG601SH1□	600 Ω ±25%	500mA	0.38 Ω max.	-55°C ~ +125°C
BLM18AG102SZ1□	BLM18AG102SH1□	1000 Ω ±25%	400mA	0.50 Ω max.	-55°C ~ +125°C

Number of Circuits: 1

■ Impedance-Frequency Characteristics (Main Items)

BLM18AG_SZ Series

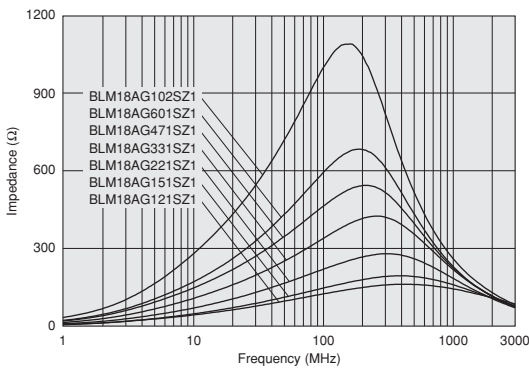

BLM18AG_SH Series

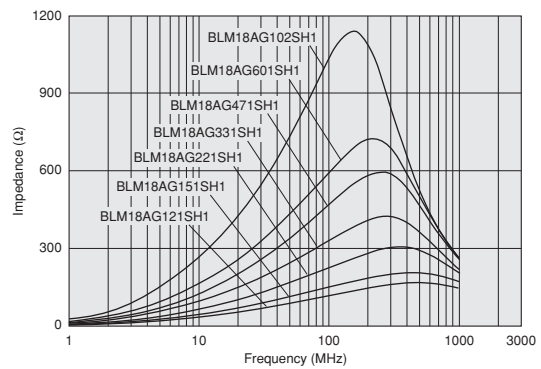

Continued on the following page. ↗

⚠Note • Please read rating and ⚠CAUTION (for storage, operating, rating, soldering, mounting and handling) in this catalog to prevent smoking and/or burning, etc.
• This catalog has only typical specifications. Therefore, please approve our product specifications or transact the approval sheet for product specifications before ordering.

SMD Type Chip Ferrite Bead
SMD Type Chip EMIFIL®
SMD Type Chip Common Mode Choke Coil
SMD Type Block Type EMIFIL®
Lead Type EMI Suppression Filters
SMD Type Microchip Transformer (Balun)

■ Impedance-Frequency Characteristics

BLM18AG121SZ1/BLM18AG121SH1

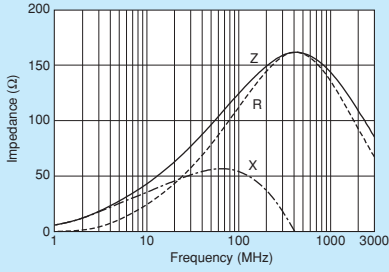

BLM18AG151SZ1/BLM18AG151SH1

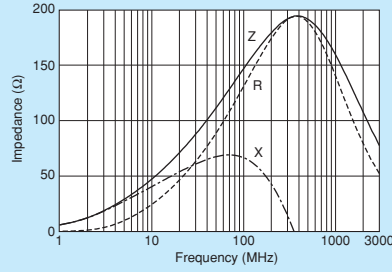

BLM18AG221SZ1/BLM18AG221SH1

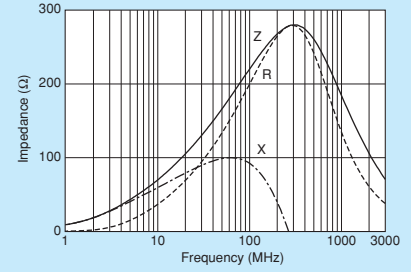

BLM18AG331SZ1/BLM18AG331SH1

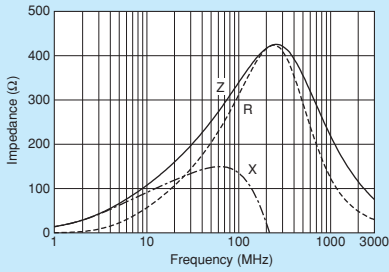

BLM18AG471SZ1/BLM18AG471SH1

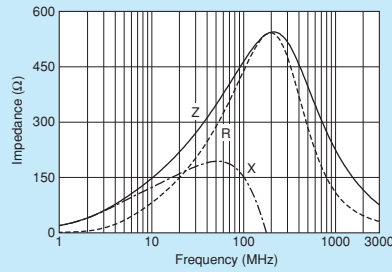

BLM18AG601SZ1/BLM18AG601SH1

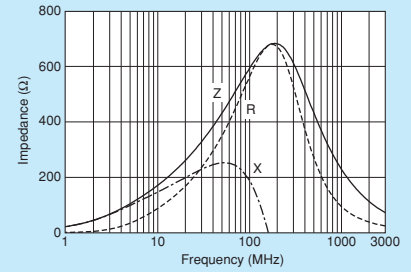

BLM18AG102SZ1/BLM18AG102SH1

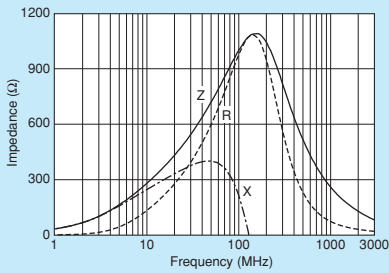

Chip Ferrite Bead
SMD Type

Chip EMIFIL®
SMD Type

Chip Common Mode Choke Coil
SMD Type

Block Type EMIFIL®
SMD Type

EMI Suppression Filters
Lead Type

Microchip Transformer (Balun)
SMD Type

⚠Note • Please read rating and ⚠CAUTION (for storage, operating, rating, soldering, mounting and handling) in this catalog to prevent smoking and/or burning, etc.
• This catalog has only typical specifications. Therefore, please approve our product specifications or transact the approval sheet for product specifications before ordering.

BLM18AG_W Series 0603/1608 (inch/mm)

0603 size for general signal lines. for conductive glue mounting.

Appearance/Dimensions

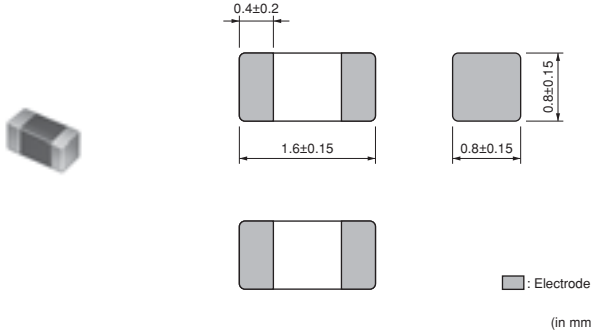

Packaging

Code	Packaging	Minimum Quantity
D	ø180mm Paper Taping	4000
J	ø330mm Paper Taping	10000
B	Packing in Bulk	1000



Equivalent Circuit

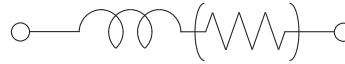

(Resistance element becomes dominant at high frequencies.)

Refer to pages from p.77 to p.80 for mounting information.

Rated Value (□: packaging code)

Part Number		Impedance (at 100MHz/20°C)	Rated Current	DC Resistance	Operating Temperature Range
For Infotainment	For Powertrain/Safety				
—	BLM18AG471WH1 □	470 Ω ±25%	200mA	0.20 Ω max.	-55°C~+150°C
—	BLM18AG102WH1 □	1000 Ω ±25%	200mA	0.70 Ω max.	-55°C~+150°C

Number of Circuits: 1

Impedance-Frequency Characteristics (Main Items)

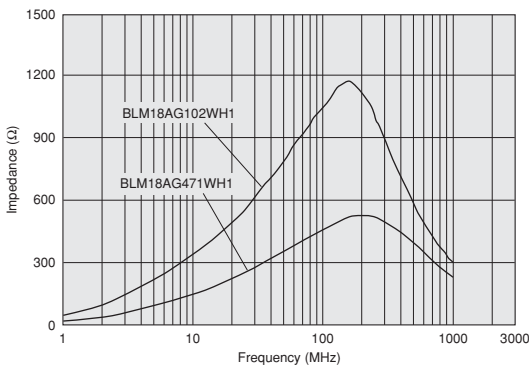

Impedance-Frequency Characteristics

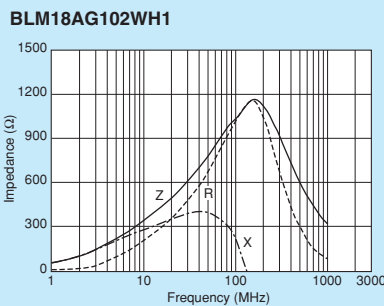
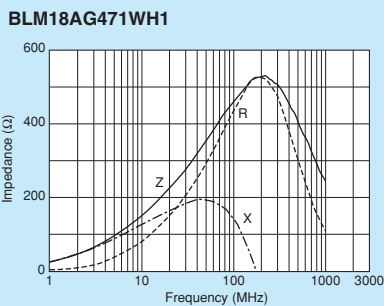

⚠Note • Please read rating and ⚠CAUTION (for storage, operating, rating, soldering, mounting and handling) in this catalog to prevent smoking and/or burning, etc.
• This catalog has only typical specifications. Therefore, please approve our product specifications or transact the approval sheet for product specifications before ordering.

BLM18B Series 0603/1608 (inch/mm)

0603 size for high speed signal lines.

■ Appearance/Dimensions

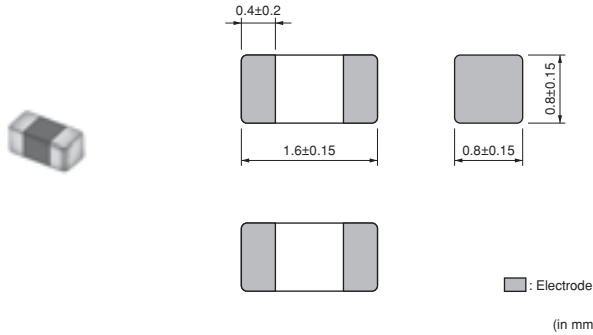

■ Packaging

Code	Packaging	Minimum Quantity
D	ø180mm Paper Taping	4000
J	ø330mm Paper Taping	10000
B	Packing in Bulk	1000



■ Equivalent Circuit

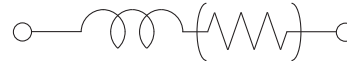

(Resistance element becomes dominant at high frequencies.)

Refer to pages from p.77 to p.80 for mounting information.

■ Rated Value (□: packaging code)

Part Number		Impedance (at 100MHz/20°C)	Rated Current	DC Resistance	Operating Temperature Range
For Infotainment	For Powertrain/Safety				
BLM18BD470SZ1□	BLM18BD470SH1□	47Ω ±25%	500mA	0.30Ω max.	-55°C~+125°C
BLM18BD121SZ1□	BLM18BD121SH1□	120Ω ±25%	200mA	0.40Ω max.	-55°C~+125°C
BLM18BD151SZ1□	BLM18BD151SH1□	150Ω ±25%	200mA	0.40Ω max.	-55°C~+125°C
BLM18BD221SZ1□	BLM18BD221SH1□	220Ω ±25%	200mA	0.45Ω max.	-55°C~+125°C
BLM18BD331SZ1□	BLM18BD331SH1□	330Ω ±25%	200mA	0.50Ω max.	-55°C~+125°C
BLM18BD421SZ1□	BLM18BD421SH1□	420Ω ±25%	200mA	0.55Ω max.	-55°C~+125°C
BLM18BD471SZ1□	BLM18BD471SH1□	470Ω ±25%	200mA	0.55Ω max.	-55°C~+125°C
BLM18BD601SZ1□	BLM18BD601SH1□	600Ω ±25%	200mA	0.65Ω max.	-55°C~+125°C
BLM18BD102SZ1□	BLM18BD102SH1□	1000Ω ±25%	100mA	0.85Ω max.	-55°C~+125°C
BLM18BD152SZ1□	BLM18BD152SH1□	1500Ω ±25%	50mA	1.20Ω max.	-55°C~+125°C
BLM18BD182SZ1□	BLM18BD182SH1□	1800Ω ±25%	50mA	1.50Ω max.	-55°C~+125°C
BLM18BD222SZ1□	BLM18BD222SH1□	2200Ω ±25%	50mA	1.50Ω max.	-55°C~+125°C
BLM18BD252SZ1□	BLM18BD252SH1□	2500Ω ±25%	50mA	1.50Ω max.	-55°C~+125°C
BLM18BB050SZ1□	BLM18BB050SH1□	5Ω ±25%	700mA	0.05Ω max.	-55°C~+125°C
BLM18BB100SZ1□	BLM18BB100SH1□	10Ω ±25%	700mA	0.10Ω max.	-55°C~+125°C
BLM18BB220SZ1□	BLM18BB220SH1□	22Ω ±25%	600mA	0.20Ω max.	-55°C~+125°C
BLM18BB470SZ1□	BLM18BB470SH1□	47Ω ±25%	550mA	0.25Ω max.	-55°C~+125°C
BLM18BB600SZ1□	BLM18BB600SH1□	60Ω ±25%	550mA	0.25Ω max.	-55°C~+125°C
BLM18BB750SZ1□	BLM18BB750SH1□	75Ω ±25%	500mA	0.30Ω max.	-55°C~+125°C
BLM18BB121SZ1□	BLM18BB121SH1□	120Ω ±25%	500mA	0.30Ω max.	-55°C~+125°C
BLM18BB141SZ1□	BLM18BB141SH1□	140Ω ±25%	450mA	0.35Ω max.	-55°C~+125°C
BLM18BB151SZ1□	BLM18BB151SH1□	150Ω ±25%	450mA	0.37Ω max.	-55°C~+125°C
BLM18BB221SZ1□	BLM18BB221SH1□	220Ω ±25%	450mA	0.45Ω max.	-55°C~+125°C
BLM18BB331SZ1□	BLM18BB331SH1□	330Ω ±25%	400mA	0.58Ω max.	-55°C~+125°C
BLM18BB471SZ1□	BLM18BB471SH1□	470Ω ±25%	300mA	0.85Ω max.	-55°C~+125°C
BLM18BA050SZ1□	BLM18BA050SH1□	5Ω ±25%	500mA	0.20Ω max.	-55°C~+125°C
BLM18BA100SZ1□	BLM18BA100SH1□	10Ω ±25%	500mA	0.25Ω max.	-55°C~+125°C
BLM18BA220SZ1□	BLM18BA220SH1□	22Ω ±25%	500mA	0.35Ω max.	-55°C~+125°C
BLM18BA470SZ1□	BLM18BA470SH1□	47Ω ±25%	300mA	0.55Ω max.	-55°C~+125°C
BLM18BA750SZ1□	BLM18BA750SH1□	75Ω ±25%	300mA	0.70Ω max.	-55°C~+125°C
BLM18BA121SZ1□	BLM18BA121SH1□	120Ω ±25%	200mA	0.90Ω max.	-55°C~+125°C

Number of Circuits: 1

Continued on the following page.

⚠Note • Please read rating and ⚠CAUTION (for storage, operating, rating, soldering, mounting and handling) in this catalog to prevent smoking and/or burning, etc.
• This catalog has only typical specifications. Therefore, please approve our product specifications or transact the approval sheet for product specifications before ordering.

Chip Ferrite Bead SMD Type

Chip EMIFIL® SMD Type

Chip Common Mode Choke Coil SMD Type

Block Type EMIFIL® SMD Type

EMI Suppression Filters Lead Type

Microchip Transformer (Balun) SMD Type

■ Impedance-Frequency Characteristics (Main Items)

BLM18BD_SZ Series (47Ω~420Ω)

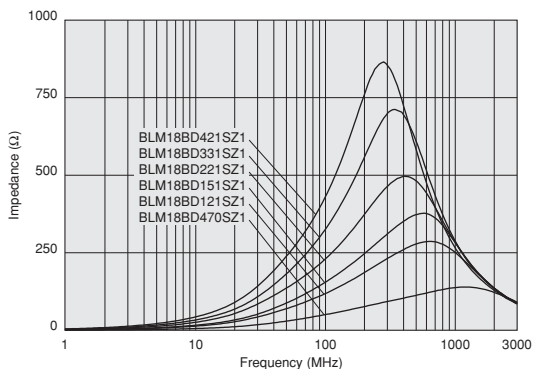

BLM18BD_SZ Series (470Ω~2500Ω)

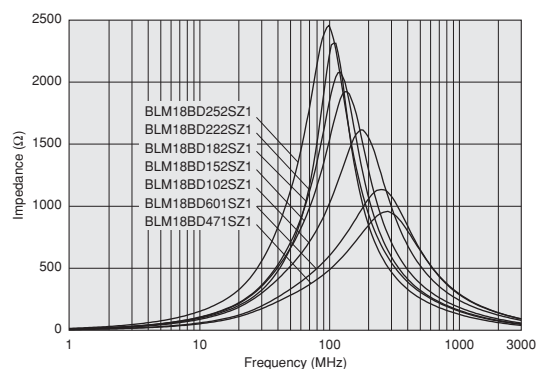

BLM18BD_SH Series

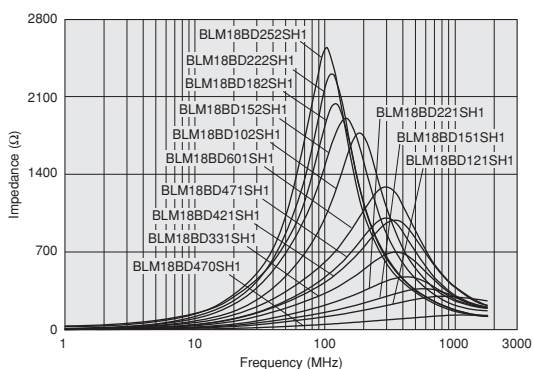

BLM18BB_SZ Series (5Ω~75Ω)

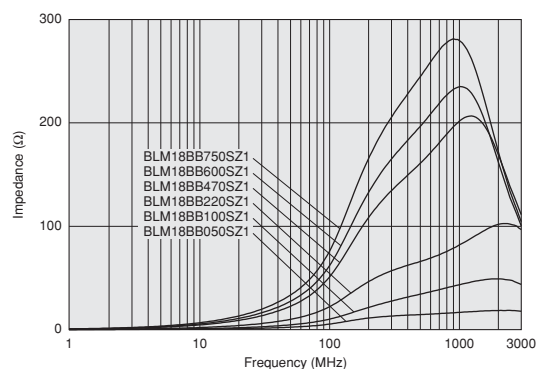

BLM18BB_SZ Series (120Ω~470Ω)

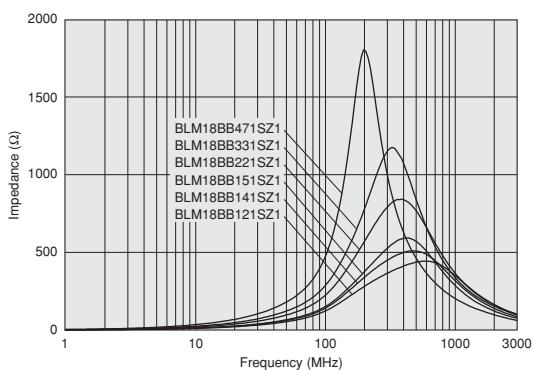

BLM18BB_SH Series (5Ω~47Ω)

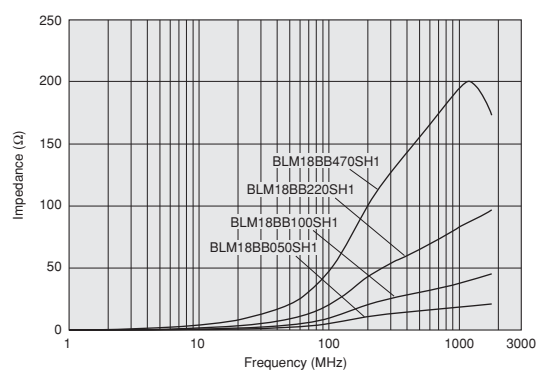

BLM18BB_SH Series (60Ω~470Ω)

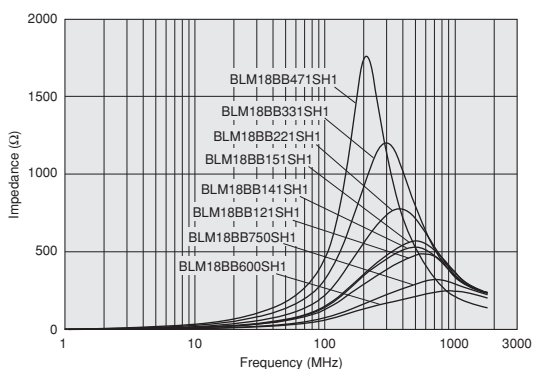

BLM18BA_SZ Series (5Ω~22Ω)

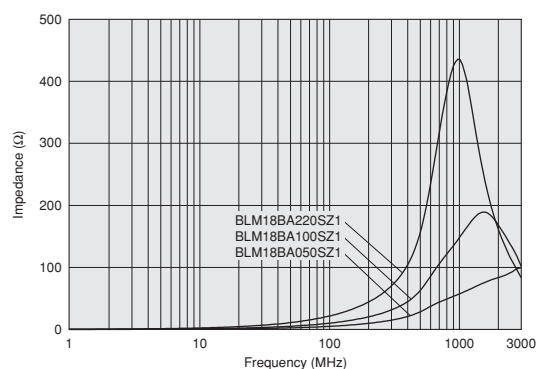

Continued on the following page.

⚠Note • Please read rating and ⚠CAUTION (for storage, operating, rating, soldering, mounting and handling) in this catalog to prevent smoking and/or burning, etc.
• This catalog has only typical specifications. Therefore, please approve our product specifications or transact the approval sheet for product specifications before ordering.

SMD Type
Chip Ferrite Bead

SMD Type
Chip EMIFIL®

SMD Type
Chip Common Mode Choke Coil

SMD Type
Block Type EMIFIL®

Lead Type
EMI Suppression Filters

SMD Type
Microchip Transformer (Balun)

■ Impedance-Frequency Characteristics (Main Items)

BLM18BA_SZ Series (47Ω~120Ω)

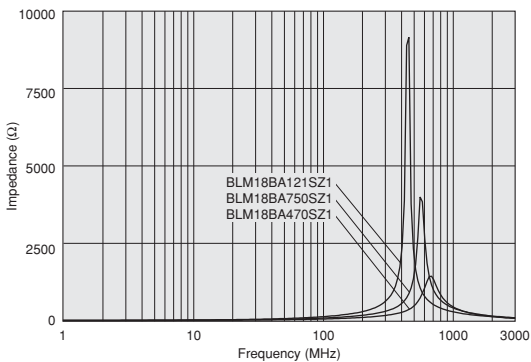

BLM18BA_SH Series (5Ω~22Ω)

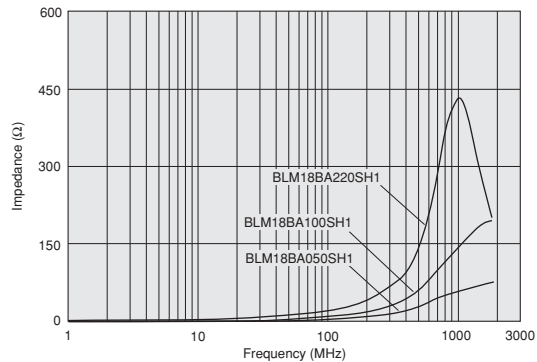

BLM18BA_SH Series (47Ω~120Ω)

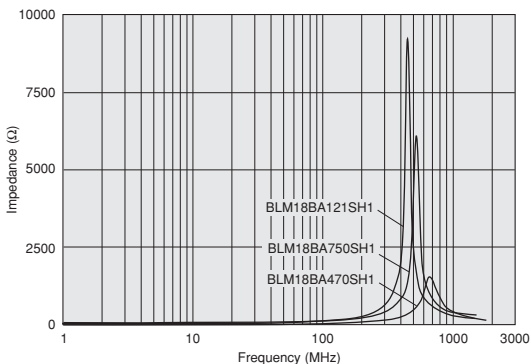

■ Impedance-Frequency Characteristics

BLM18BD470SZ1/BLM18BD470SH1

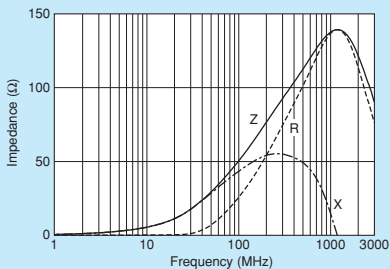

BLM18BD121SZ1/BLM18BD121SH1

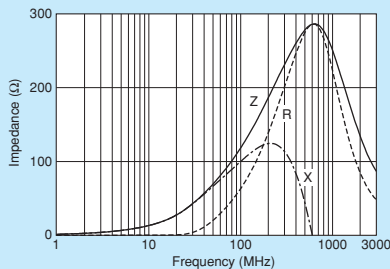

BLM18BD151SZ1/BLM18BD151SH1

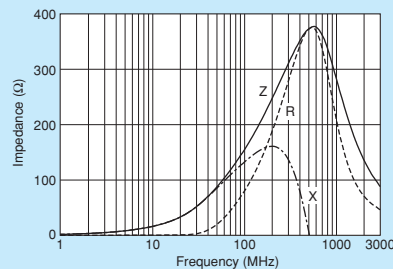

BLM18BD221SZ1/BLM18BD221SH1

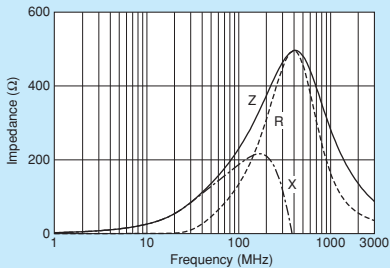

BLM18BD331SZ1/BLM18BD331SH1

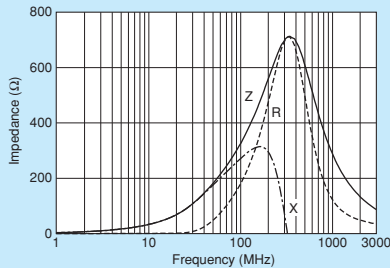

BLM18BD421SZ1/BLM18BD421SH1

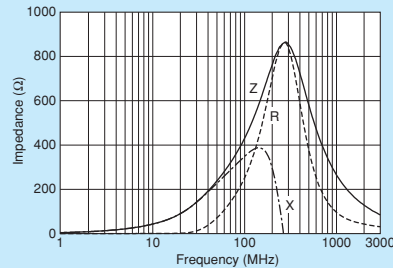

Continued on the following page.

⚠Note • Please read rating and ⚠CAUTION (for storage, operating, rating, soldering, mounting and handling) in this catalog to prevent smoking and/or burning, etc.
• This catalog has only typical specifications. Therefore, please approve our product specifications or transact the approval sheet for product specifications before ordering.

Chip Ferrite Bead
SMD Type

Chip EMIFIL®
SMD Type

Chip Common Mode Choke Coil
SMD Type

Block Type EMIFIL®
SMD Type

Block Type EMI Suppression Filters
Lead Type

Microchip Transformer (Balun)
SMD Type

■ Impedance-Frequency Characteristics

BLM18BD471SZ1/BLM18BD471SH1

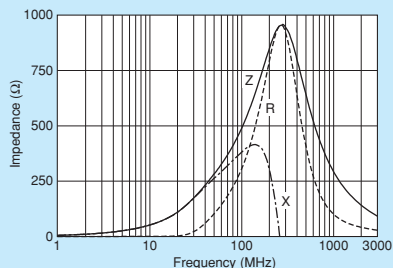

BLM18BD601SZ1/BLM18BD601SH1

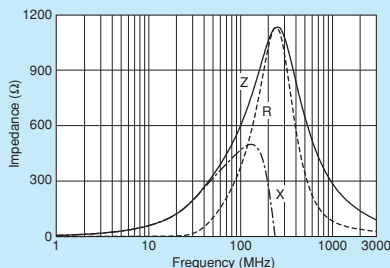

BLM18BD102SZ1/BLM18BD102SH1

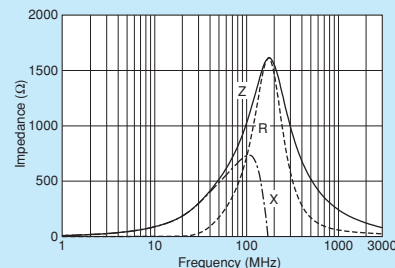

BLM18BD152SZ1/BLM18BD152SH1

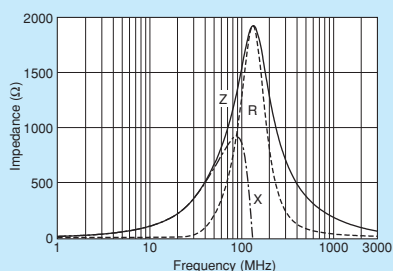

BLM18BD182SZ1/BLM18BD182SH1

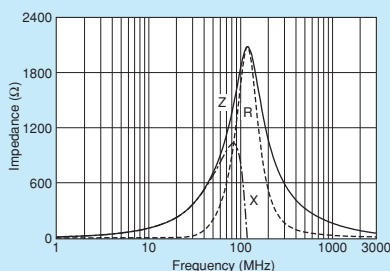

BLM18BD222SZ1/BLM18BD222SH1

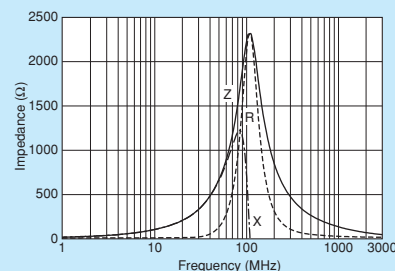

BLM18BD252SZ1/BLM18BD252SH1

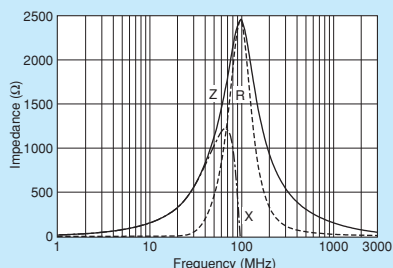

BLM18BB050SZ1/BLM18BB050SH1

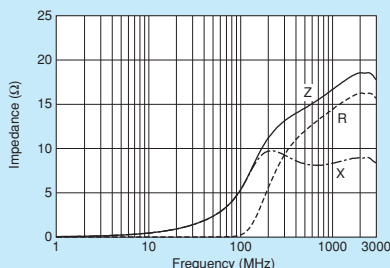

BLM18BB100SZ1/BLM18BB100SH1

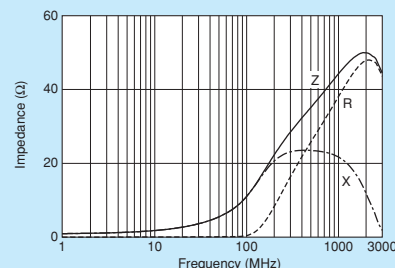

BLM18BB220SZ1/BLM18BB220SH1

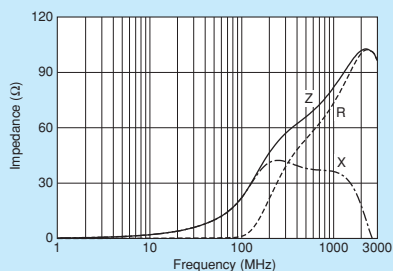

BLM18BB470SZ1/BLM18BB470SH1

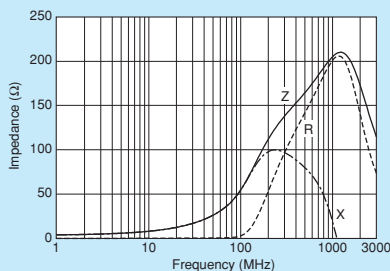

BLM18BB600SZ1/BLM18BB600SH1

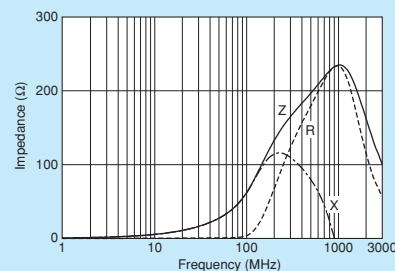

BLM18BB750SZ1/BLM18BB750SH1

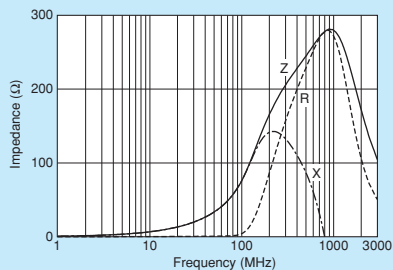

BLM18BB121SZ1/BLM18BB121SH1

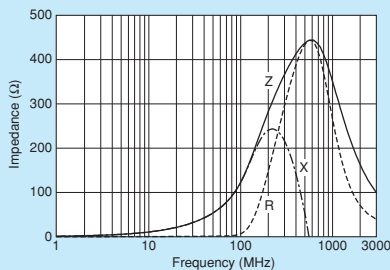

BLM18BB141SZ1/BLM18BB141SH1

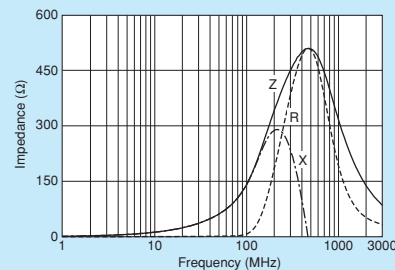

Continued on the following page.

⚠Note • Please read rating and ⚠CAUTION (for storage, operating, rating, soldering, mounting and handling) in this catalog to prevent smoking and/or burning, etc.
• This catalog has only typical specifications. Therefore, please approve our product specifications or transact the approval sheet for product specifications before ordering.

SMD Type
Chip Ferrite Bead
SMD Type
Chip EMIFIL®
SMD Type
Chip Common Mode Choke Coil
SMD Type
Block Type EMIFIL®
Lead Type
EMI Suppression Filters
SMD Type
Microchip Transformer (Balun)

■ Impedance-Frequency Characteristics

BLM18BB151SZ1/BLM18BB151SH1

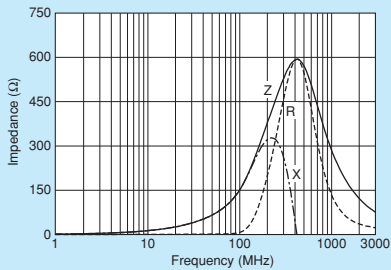

BLM18BB221SZ1/BLM18BB221SH1

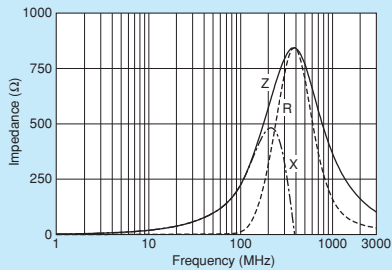

BLM18BB331SZ1/BLM18BB331SH1

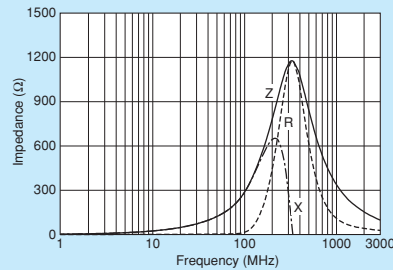

BLM18BB471SZ1/BLM18BB471SH1

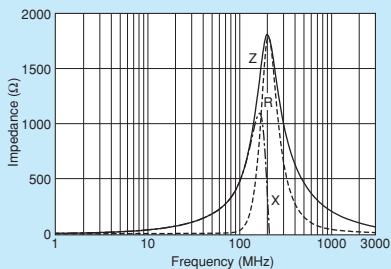

BLM18BA050SZ1/BLM18BA050SH1

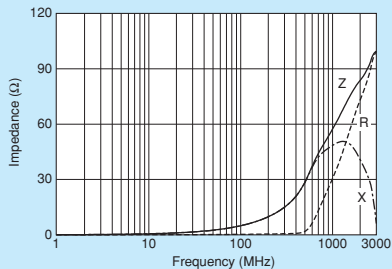

BLM18BA100SZ1/BLM18BA100SH1

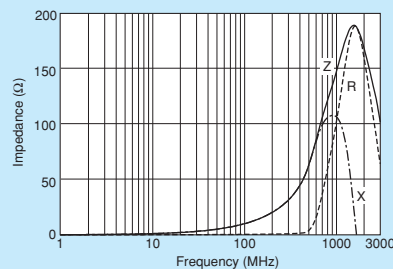

BLM18BA220SZ1/BLM18BA220SH1

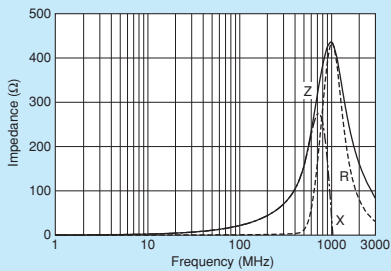

BLM18BA470SZ1/BLM18BA470SH1

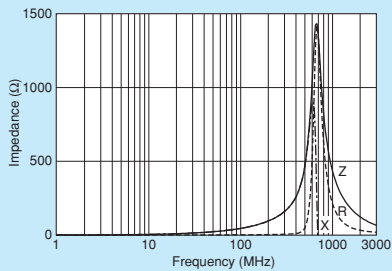

BLM18BA750SZ1/BLM18BA750SH1

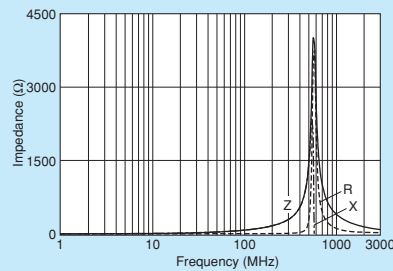

BLM18BA121SZ1/BLM18BA121SH1

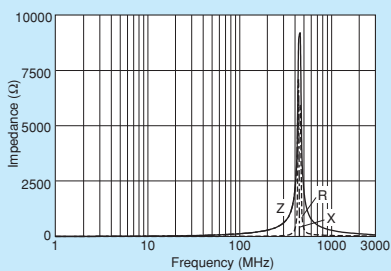

Chip Ferrite Bead
SMD Type

Chip EMIFIL®
SMD Type

Chip Common Mode Choke Coil
SMD Type

Block Type EMIFIL®
SMD Type

EMI Suppression Filters
Lead Type

Microchip Transformer (Balun)
SMD Type

⚠Note • Please read rating and ⚠CAUTION (for storage, operating, rating, soldering, mounting and handling) in this catalog to prevent smoking and/or burning, etc.
• This catalog has only typical specifications. Therefore, please approve our product specifications or transact the approval sheet for product specifications before ordering.

BLM21PG Series 0805/2012 (inch/mm)

0805 size for power lines.

■ Appearance/Dimensions

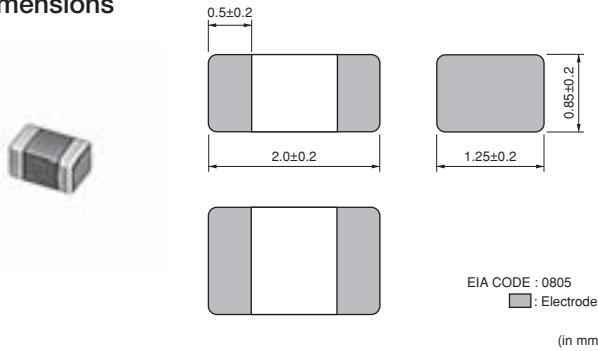

■ Packaging

Code	Packaging	Minimum Quantity
D	ø180mm Paper Taping	4000
J	ø330mm Paper Taping	10000
B	Packing in Bulk	1000

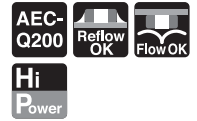

■ Equivalent Circuit

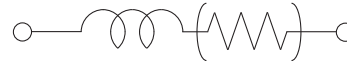

(Resistance element becomes dominant at high frequencies.)

Refer to pages from p.77 to p.80 for mounting information.

■ Rated Value (□: packaging code)

Part Number		Impedance (at 100MHz/20°C)	Rated Current	DC Resistance	Operating Temperature Range
For Infotainment	For Powertrain/Safety				
BLM21PG220SZ1□	BLM21PG220SH1□	22Ω ±25%	6000mA	0.009Ω max.	-55°C~+125°C
BLM21PG300SZ1□	BLM21PG300SH1□	30Ω (Typ.)	4000mA	0.014Ω max.	-55°C~+125°C
BLM21PG600SZ1□	BLM21PG600SH1□	60Ω ±25%	3500mA	0.02Ω max.	-55°C~+125°C
BLM21PG121SZ1□	BLM21PG121SH1□	120Ω ±25%	3000mA	0.03Ω max.	-55°C~+125°C
BLM21PG221SZ1□	BLM21PG221SH1□	220Ω ±25%	2000mA	0.045Ω max.	-55°C~+125°C
BLM21PG331SZ1□	BLM21PG331SH1□	330Ω ±25%	1500mA	0.07Ω max.	-55°C~+125°C

Number of Circuits: 1

■ Impedance-Frequency Characteristics (Main Items)

BLM21PG_SZ Series

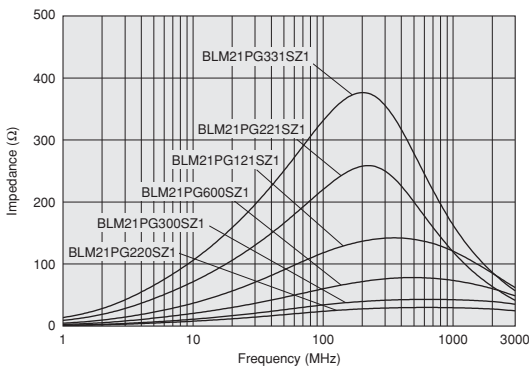

BLM21PG_SH Series

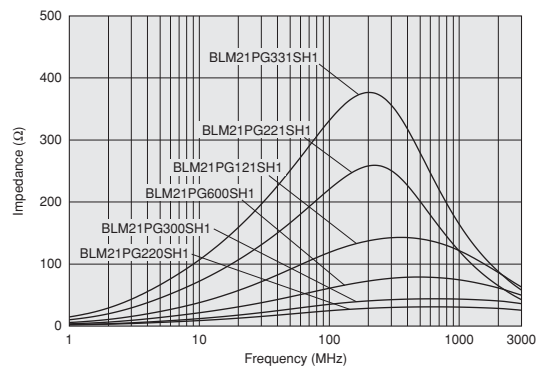

Continued on the following page. ↗

⚠Note • Please read rating and ⚠CAUTION (for storage, operating, rating, soldering, mounting and handling) in this catalog to prevent smoking and/or burning, etc.
• This catalog has only typical specifications. Therefore, please approve our product specifications or transact the approval sheet for product specifications before ordering.

Derating of Rated Current

In operating temperature exceeding +85°C, derating of current is necessary for BLM21PG series.

Please apply the derating curve shown in chart according to the operating temperature.

Derating of Rated Current

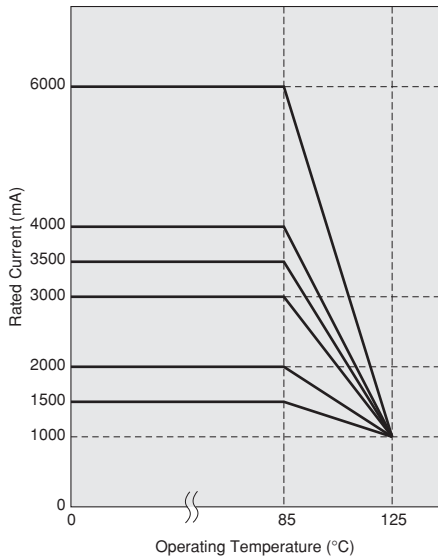

Impedance-Frequency Characteristics

BLM21PG220SZ1/BLM21PG220SH1

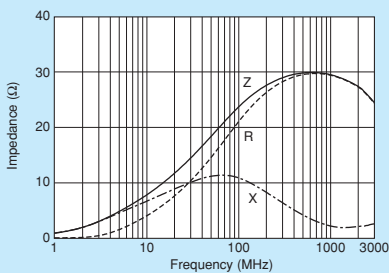

BLM21PG300SZ1/BLM21PG300SH1

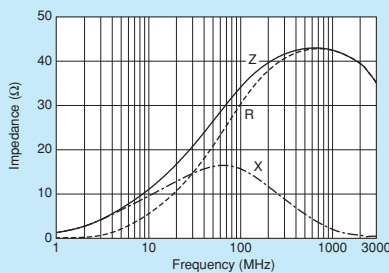

BLM21PG600SZ1/BLM21PG600SH1

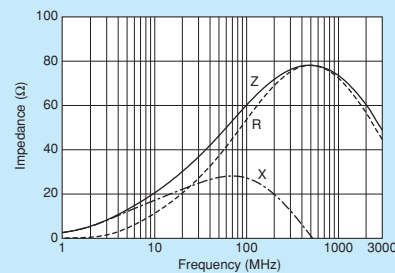

BLM21PG121SZ1/BLM21PG121SH1

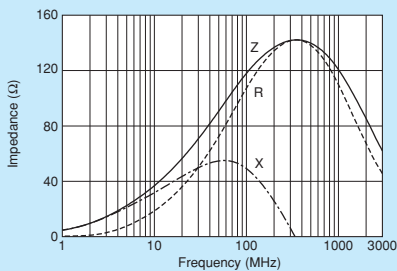

BLM21PG221SZ1/BLM21PG221SH1

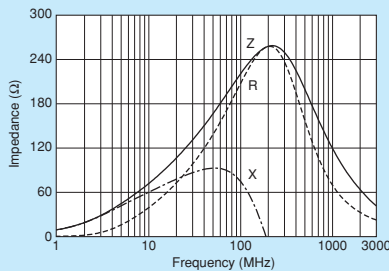

BLM21PG331SZ1/BLM21PG331SH1

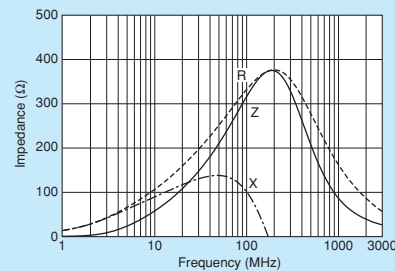

⚠Note • Please read rating and ⚠CAUTION (for storage, operating, rating, soldering, mounting and handling) in this catalog to prevent smoking and/or burning, etc.
• This catalog has only typical specifications. Therefore, please approve our product specifications or transact the approval sheet for product specifications before ordering.

BLM21AG Series 0805/2012 (inch/mm)

0805 size for general signal lines.

■ Appearance/Dimensions

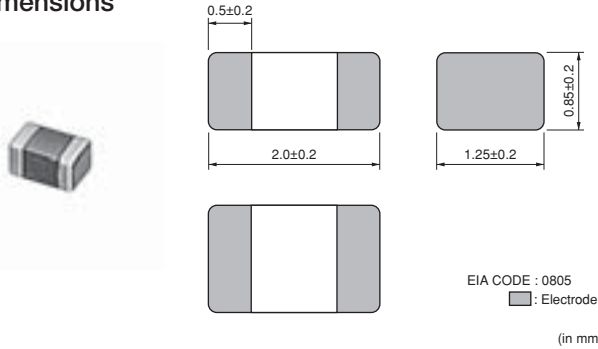

■ Packaging

Code	Packaging	Minimum Quantity
D	ø180mm Paper Taping	4000
J	ø330mm Paper Taping	10000
B	Packing in Bulk	1000



■ Equivalent Circuit

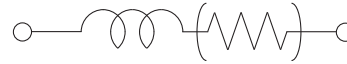

(Resistance element becomes dominant at high frequencies.)

Refer to pages from p.77 to p.80 for mounting information.

■ Rated Value (□: packaging code)

Part Number		Impedance (at 100MHz/20°C)	Rated Current	DC Resistance	Operating Temperature Range
For Infotainment	For Powertrain/Safety				
BLM21AG121SZ1□	BLM21AG121SH1□	120 Ω ±25%	800mA	0.10 Ω max.	-55°C~+125°C
BLM21AG151SZ1□	BLM21AG151SH1□	150 Ω ±25%	800mA	0.10 Ω max.	-55°C~+125°C
BLM21AG221SZ1□	BLM21AG221SH1□	220 Ω ±25%	800mA	0.13 Ω max.	-55°C~+125°C
BLM21AG331SZ1□	BLM21AG331SH1□	330 Ω ±25%	700mA	0.16 Ω max.	-55°C~+125°C
BLM21AG471SZ1□	BLM21AG471SH1□	470 Ω ±25%	700mA	0.19 Ω max.	-55°C~+125°C
BLM21AG601SZ1□	BLM21AG601SH1□	600 Ω ±25%	600mA	0.21 Ω max.	-55°C~+125°C
BLM21AG102SZ1□	BLM21AG102SH1□	1000 Ω ±25%	500mA	0.28 Ω max.	-55°C~+125°C

Number of Circuits: 1

■ Impedance-Frequency Characteristics (Main Items)

BLM21AG_SZ Series

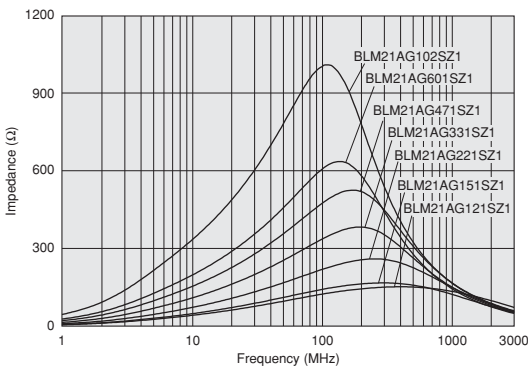

BLM21AG_SH Series

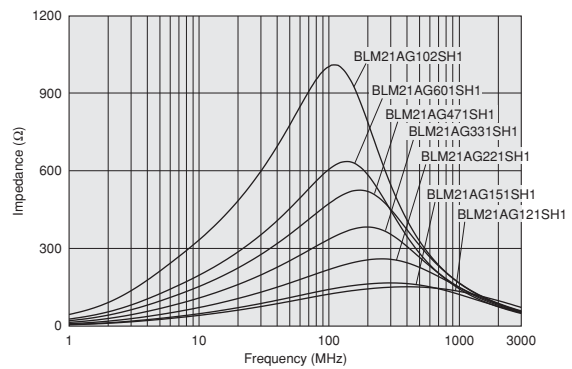

Continued on the following page. ↗

△Note • Please read rating and △CAUTION (for storage, operating, rating, soldering, mounting and handling) in this catalog to prevent smoking and/or burning, etc.
 • This catalog has only typical specifications. Therefore, please approve our product specifications or transact the approval sheet for product specifications before ordering.

■ Impedance-Frequency Characteristics

BLM21AG121SZ1/BLM21AG121SH1

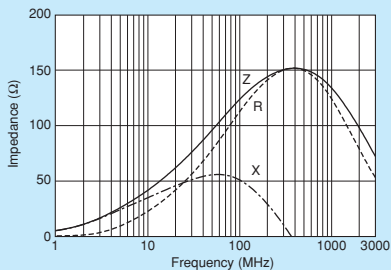

BLM21AG151SZ1/BLM21AG151SH1

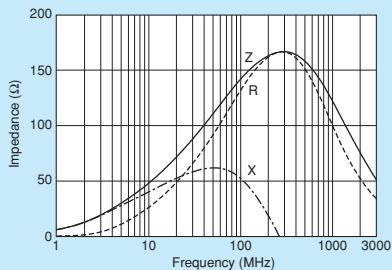

BLM21AG221SZ1/BLM21AG221SH1

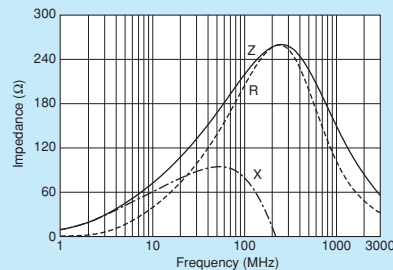

BLM21AG331SZ1/BLM21AG331SH1

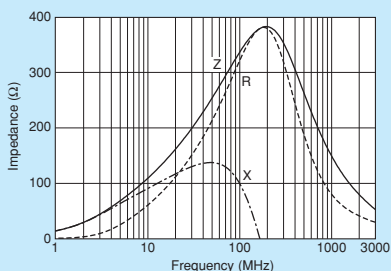

BLM21AG471SZ1/BLM21AG471SH1

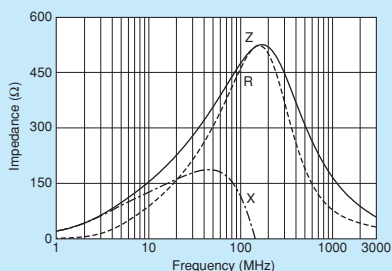

BLM21AG601SZ1/BLM21AG601SH1

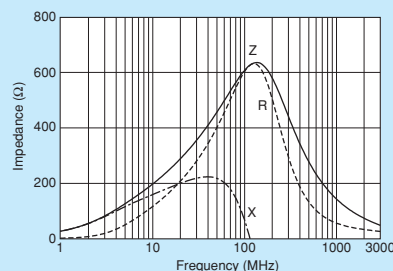

BLM21AG102SZ1/BLM21AG102SH1

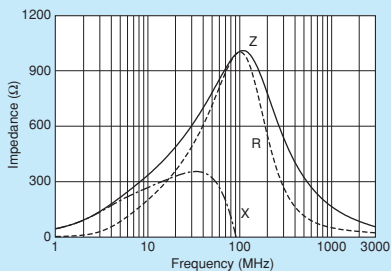

Chip Ferrite Bead
SMD Type

Chip EMIFIL®
SMD Type

Chip Common Mode Choke Coil
SMD Type

Block Type EMIFIL®
SMD Type

EMI Suppression Filters
Lead Type

Microchip Transformer (Balun)
SMD Type

⚠Note • Please read rating and ⚠CAUTION (for storage, operating, rating, soldering, mounting and handling) in this catalog to prevent smoking and/or burning, etc.
• This catalog has only typical specifications. Therefore, please approve our product specifications or transact the approval sheet for product specifications before ordering.

BLM21B Series 0805/2012 (inch/mm)

0805 size for high speed signal lines.

■ Appearance/ Dimensions

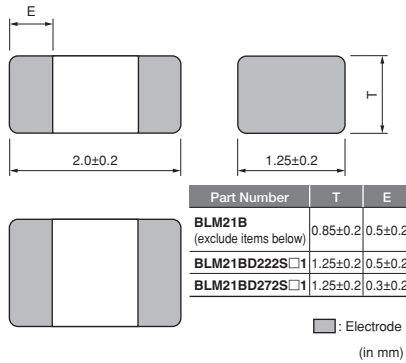

■ Packaging

• All except for BLM21BD222SZ1/21BD272SZ1

Code	Packaging	Minimum Quantity
D	ø180mm Paper Taping	4000
J	ø330mm Paper Taping	10000
B	Packing in Bulk	1000



• BLM21BD222SZ1/21BD272SZ1 only

Code	Packaging	Minimum Quantity
L	180mm Plastic Tape	3000
K	330mm Plastic Tape	10000
B	Bulk(Bag)	1000

■ Equivalent Circuit



(Resistance element becomes dominant at high frequencies.)

Refer to pages from p.77 to p.80 for mounting information.

■ Rated Value (□: packaging code)

Part Number		Impedance (at 100MHz/20°C)	Rated Current	DC Resistance	Operating Temperature Range
For Infotainment	For Powertrain/Safety				
BLM21BD121SZ1□	BLM21BD121SH1□	120 Ω ±25%	200mA	0.25 Ω max.	-55°C ~ +125°C
BLM21BD151SZ1□	BLM21BD151SH1□	150 Ω ±25%	200mA	0.25 Ω max.	-55°C ~ +125°C
BLM21BD221SZ1□	BLM21BD221SH1□	220 Ω ±25%	200mA	0.25 Ω max.	-55°C ~ +125°C
BLM21BD331SZ1□	BLM21BD331SH1□	330 Ω ±25%	200mA	0.30 Ω max.	-55°C ~ +125°C
BLM21BD421SZ1□	BLM21BD421SH1□	420 Ω ±25%	200mA	0.30 Ω max.	-55°C ~ +125°C
BLM21BD471SZ1□	BLM21BD471SH1□	470 Ω ±25%	200mA	0.35 Ω max.	-55°C ~ +125°C
BLM21BD601SZ1□	BLM21BD601SH1□	600 Ω ±25%	200mA	0.35 Ω max.	-55°C ~ +125°C
BLM21BD751SZ1□	BLM21BD751SH1□	750 Ω ±25%	200mA	0.40 Ω max.	-55°C ~ +125°C
BLM21BD102SZ1□	BLM21BD102SH1□	1000 Ω ±25%	200mA	0.40 Ω max.	-55°C ~ +125°C
BLM21BD152SZ1□	BLM21BD152SH1□	1500 Ω ±25%	200mA	0.45 Ω max.	-55°C ~ +125°C
BLM21BD182SZ1□	BLM21BD182SH1□	1800 Ω ±25%	200mA	0.50 Ω max.	-55°C ~ +125°C
BLM21BD222TZ1□	BLM21BD222TH1□	2200 Ω ±25%	200mA	0.60 Ω max.	-55°C ~ +125°C
BLM21BD222SZ1□	BLM21BD222SH1□	2250 Ω (Typ.)	200mA	0.60 Ω max.	-55°C ~ +125°C
BLM21BD272SZ1□	BLM21BD272SH1□	2700 Ω ±25%	200mA	0.80 Ω max.	-55°C ~ +125°C
BLM21BB050SZ1□	BLM21BB050SH1□	5 Ω ±25%	1000mA	0.02 Ω max.	-55°C ~ +125°C
BLM21BB600SZ1□	BLM21BB600SH1□	60 Ω ±25%	800mA	0.13 Ω max.	-55°C ~ +125°C
BLM21BB750SZ1□	BLM21BB750SH1□	75 Ω ±25%	700mA	0.16 Ω max.	-55°C ~ +125°C
BLM21BB121SZ1□	BLM21BB121SH1□	120 Ω ±25%	600mA	0.19 Ω max.	-55°C ~ +125°C
BLM21BB151SZ1□	BLM21BB151SH1□	150 Ω ±25%	600mA	0.21 Ω max.	-55°C ~ +125°C
BLM21BB201SZ1□	BLM21BB201SH1□	200 Ω ±25%	500mA	0.26 Ω max.	-55°C ~ +125°C
BLM21BB221SZ1□	BLM21BB221SH1□	220 Ω ±25%	500mA	0.26 Ω max.	-55°C ~ +125°C
BLM21BB331SZ1□	BLM21BB331SH1□	330 Ω ±25%	400mA	0.33 Ω max.	-55°C ~ +125°C
BLM21BB471SZ1□	BLM21BB471SH1□	470 Ω ±25%	400mA	0.40 Ω max.	-55°C ~ +125°C

Number of Circuits: 1

Continued on the following page.

△Note • Please read rating and △CAUTION (for storage, operating, rating, soldering, mounting and handling) in this catalog to prevent smoking and/or burning, etc.
• This catalog has only typical specifications. Therefore, please approve our product specifications or transact the approval sheet for product specifications before ordering.

SMD Type Chip Ferrite Bead
SMD Type Chip EMIFIL®
SMD Type Chip Common Mode Choke Coil
SMD Type Block Type EMIFIL®
Lead Type EMI Suppression Filters
SMD Type Microchip Transformer (Balun)

Impedance-Frequency Characteristics (Main Items)

BLM21BD_SZ, TZ Series

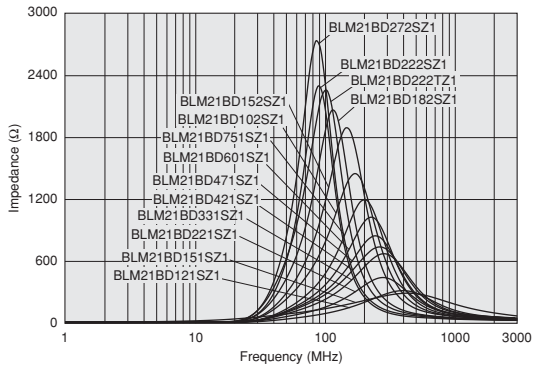

BLM21BD_SH, TH Series

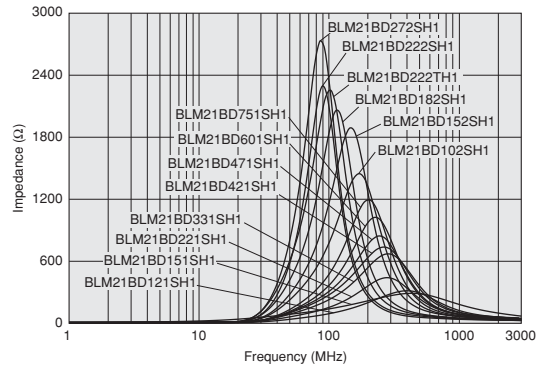

BLM21BB_SZ Series

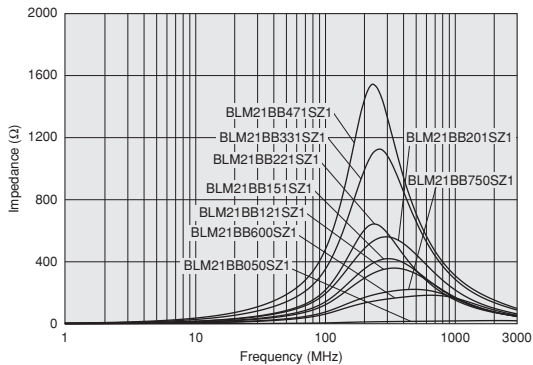

BLM21BB_SH Series

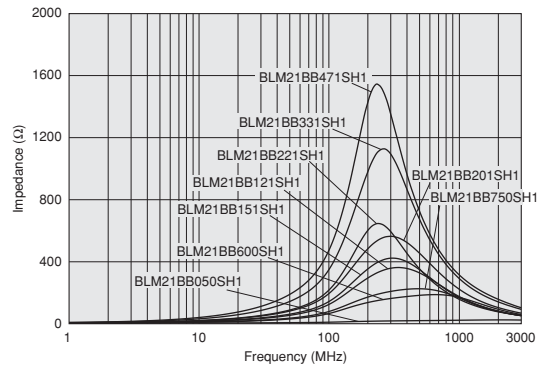

Impedance-Frequency Characteristics

BLM21BD121SZ1/BLM21BD121SH1

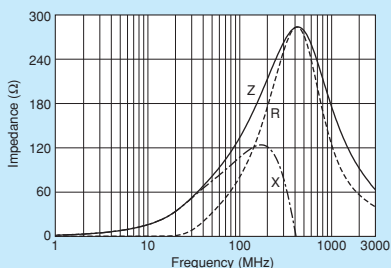

BLM21BD151SZ1/BLM21BD151SH1

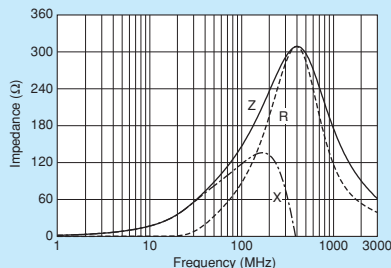

BLM21BD221SZ1/BLM21BD221SH1

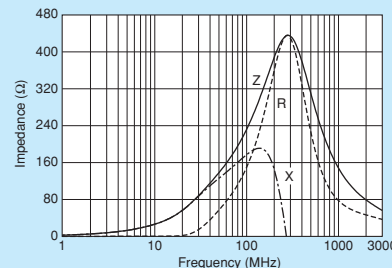

BLM21BD331SZ1/BLM21BD331SH1

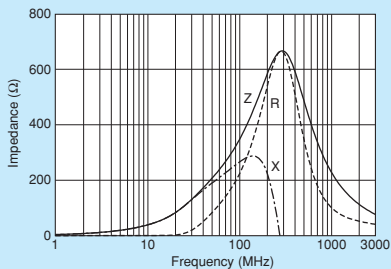

BLM21BD421SZ1/BLM21BD421SH1

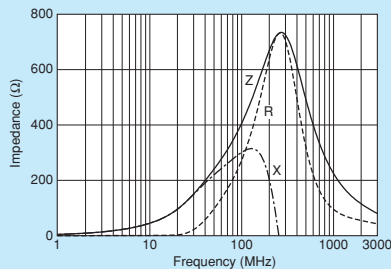

BLM21BD471SZ1/BLM21BD471SH1

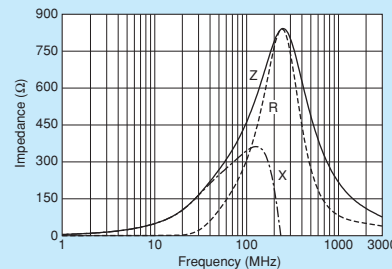

Continued on the following page.

Note • Please read rating and CAUTION (for storage, operating, rating, soldering, mounting and handling) in this catalog to prevent smoking and/or burning, etc.
 • This catalog has only typical specifications. Therefore, please approve our product specifications or transact the approval sheet for product specifications before ordering.

Chip Ferrite Bead SMD Type
 Chip EMIFIL® SMD Type
 Chip Common Mode Choke Coil SMD Type
 Block Type EMIFIL® SMD Type
 EMI Suppression Filters Lead Type
 Microchip Transformer (Balun) SMD Type

Impedance-Frequency Characteristics

BLM21BD601SZ1/BLM21BD601SH1

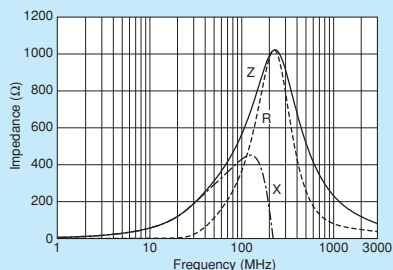

BLM21BD751SZ1/BLM21BD751SH1

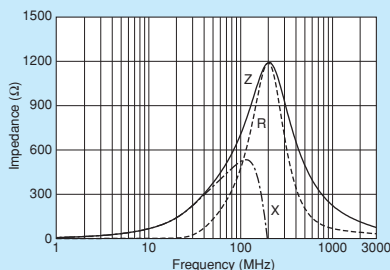

BLM21BD102SZ1/BLM21BD102SH1

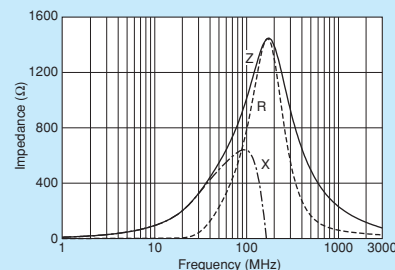

BLM21BD152SZ1/BLM21BD152SH1

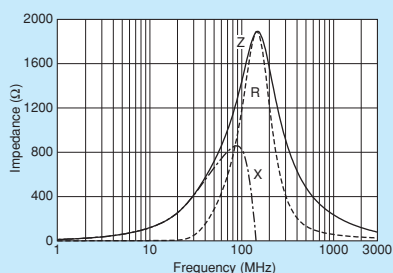

BLM21BD182SZ1/BLM21BD182SH1

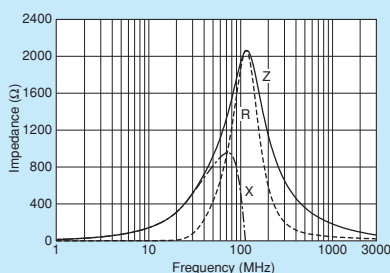

BLM21BD222TZ1/BLM21BD222TH1

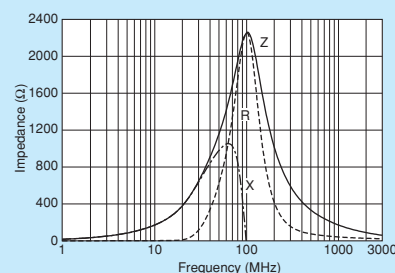

BLM21BD222SZ1/BLM21BD222SH1

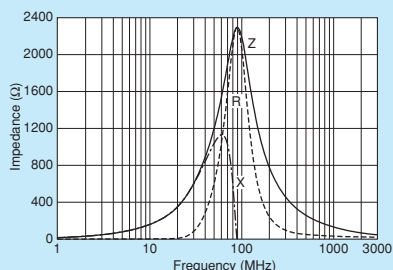

BLM21BD272SZ1/BLM21BD272SH1

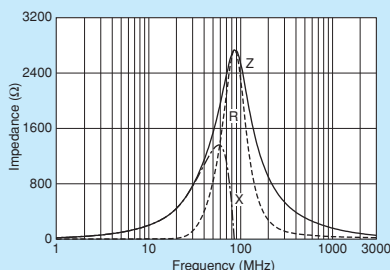

BLM21BB050SZ1/BLM21BB050SH1

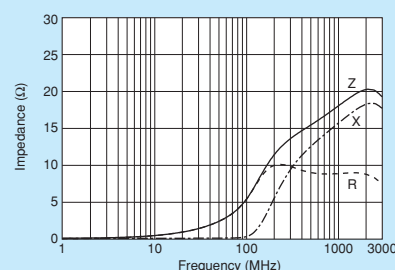

BLM21BB600SZ1/BLM21BB600SH1

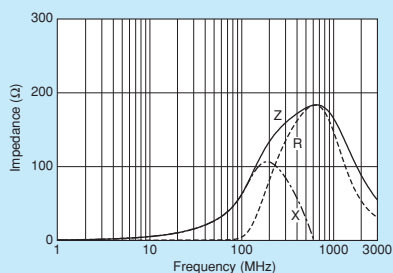

BLM21BB750SZ1/BLM21BB750SH1

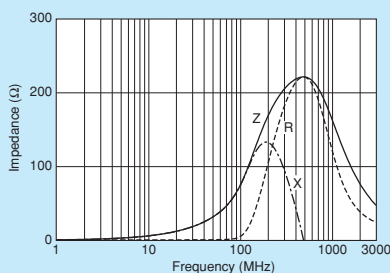

BLM21BB121SZ1/BLM21BB121SH1

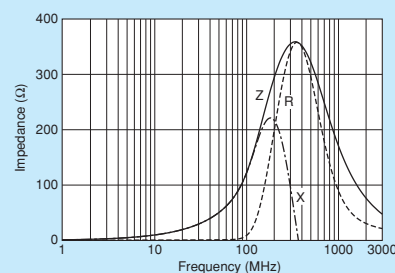

BLM21BB151SZ1/BLM21BB151SH1

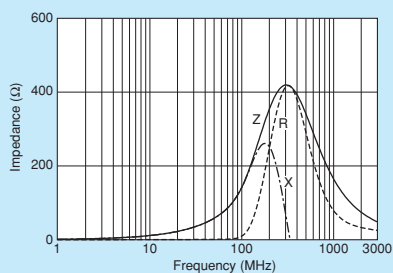

BLM21BB201SZ1/BLM21BB201SH1

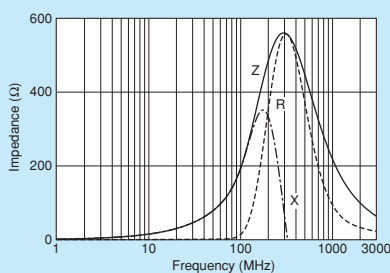

BLM21BB221SZ1/BLM21BB221SH1

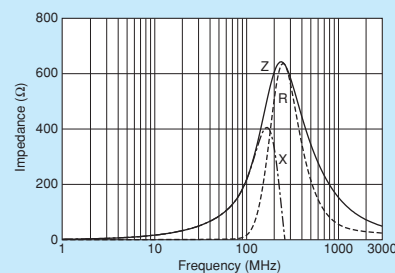

Continued on the following page.

Note • Please read rating and **CAUTION** (for storage, operating, rating, soldering, mounting and handling) in this catalog to prevent smoking and/or burning, etc.
• This catalog has only typical specifications. Therefore, please approve our product specifications or transact the approval sheet for product specifications before ordering.

SMD Type
Chip Ferrite Bead
SMD Type
Chip EMIFIL®
SMD Type
Chip Common Mode Choke Coil
SMD Type
Block Type EMIFIL®
Lead Type
EMI Suppression Filters
SMD Type
Microchip Transformer (Balun)

■ Impedance-Frequency Characteristics

BLM21BB331SZ1/BLM21BB331SH1

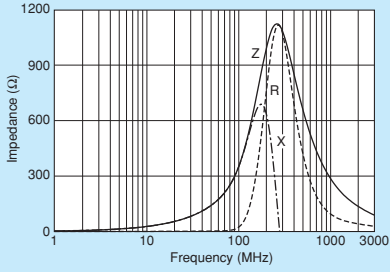

BLM21BB471SZ1/BLM21BB471SH1

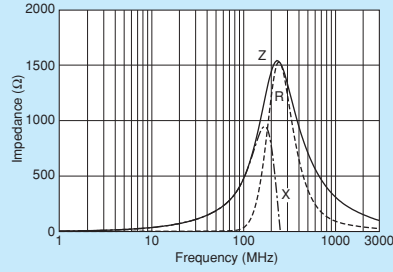

Chip Ferrite Bead
SMD Type

Chip EMIFIL®
SMD Type

Chip Common Mode Choke Coil
SMD Type

Block Type EMIFIL®
SMD Type

EMI Suppression Filters
Lead Type

Microchip Transformer (Balun)
SMD Type

⚠Note • Please read rating and ⚠CAUTION (for storage, operating, rating, soldering, mounting and handling) in this catalog to prevent smoking and/or burning, etc.
• This catalog has only typical specifications. Therefore, please approve our product specifications or transact the approval sheet for product specifications before ordering.

BLM31PG Series 1206/3216 (inch/mm)

1206 size for power lines.

■ Appearance/Dimensions

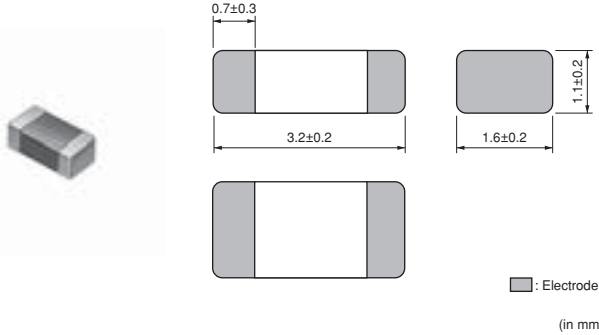

■ Packaging

Code	Packaging	Minimum Quantity
L	ø180mm Embossed Taping	3000
K	ø330mm Embossed Taping	10000
B	Packing in Bulk	1000

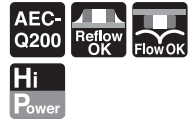

■ Equivalent Circuit

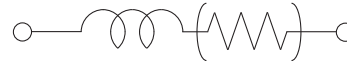

(Resistance element becomes dominant at high frequencies.)

Refer to pages from p.77 to p.80 for mounting information.

■ Rated Value (□: packaging code)

Part Number		Impedance (at 100MHz/20°C)	Rated Current	DC Resistance	Operating Temperature Range
For Infotainment	For Powertrain/Safety				
BLM31PG330SZ1□	BLM31PG330SH1□	33Ω ±25%	6000mA	0.009Ω max.	-55°C~+125°C
BLM31PG500SZ1□	BLM31PG500SH1□	50Ω (Typ.)	3500mA	0.015Ω max.	-55°C~+125°C
BLM31PG121SZ1□	BLM31PG121SH1□	120Ω ±25%	3500mA	0.02Ω max.	-55°C~+125°C
BLM31PG391SZ1□	BLM31PG391SH1□	390Ω ±25%	2000mA	0.05Ω max.	-55°C~+125°C
BLM31PG601SZ1□	BLM31PG601SH1□	600Ω ±25%	1500mA	0.08Ω max.	-55°C~+125°C

Number of Circuits: 1

■ Impedance-Frequency Characteristics (Main Items)

BLM31PG_SZ Series

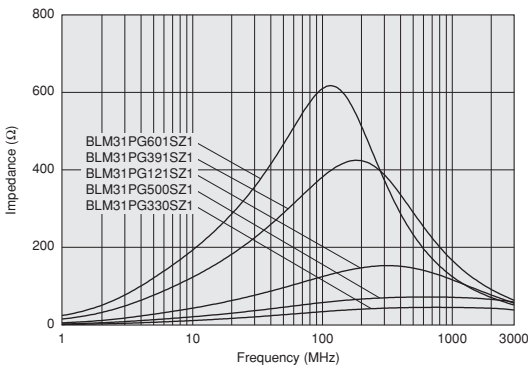

BLM31PG_SH Series

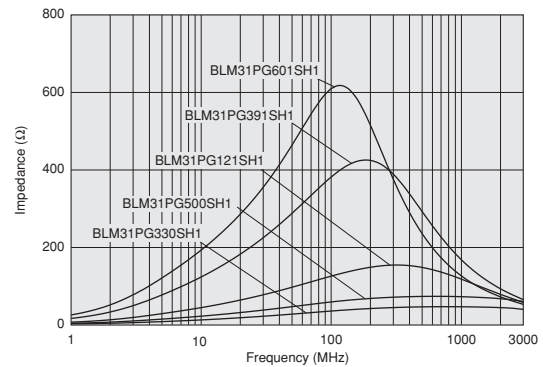

Continued on the following page.

△Note • Please read rating and △CAUTION (for storage, operating, rating, soldering, mounting and handling) in this catalog to prevent smoking and/or burning, etc.
• This catalog has only typical specifications. Therefore, please approve our product specifications or transact the approval sheet for product specifications before ordering.

Derating of Rated Current

In operating temperature exceeding +85°C, derating of current is necessary for BLM31PG series.

Please apply the derating curve shown in chart according to the operating temperature.

Derating of Rated Current

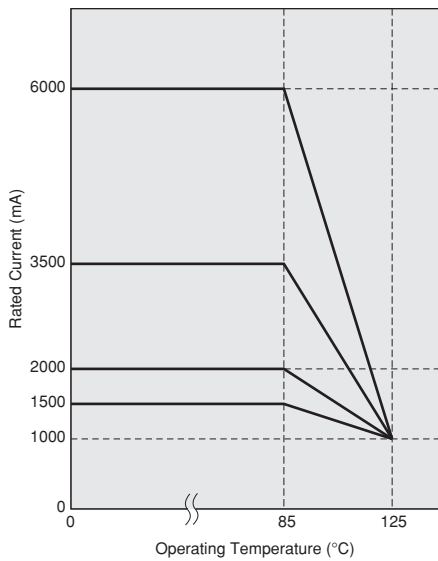

Impedance-Frequency Characteristics

BLM31PG330SZ1/BLM31PG330SH1

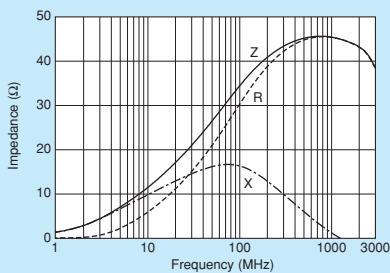

BLM31PG500SZ1/BLM31PG500SH1

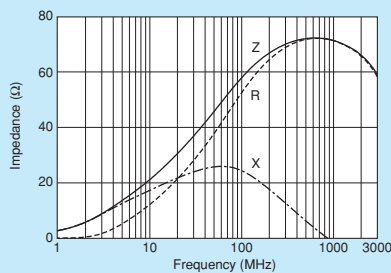

BLM31PG121SZ1/BLM31PG121SH1

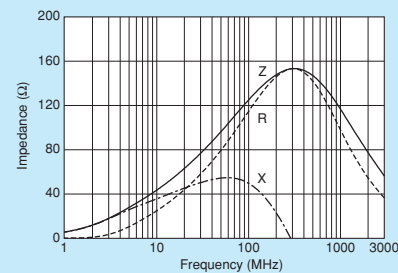

BLM31PG391SZ1/BLM31PG391SH1

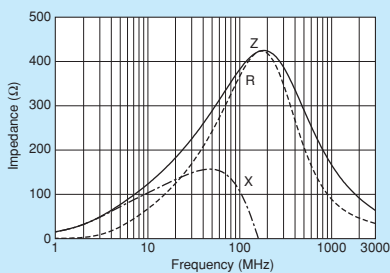

BLM31PG601SZ1/BLM31PG601SH1

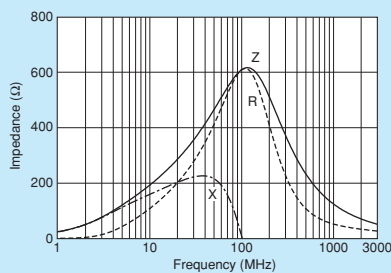

⚠Note • Please read rating and ⚠CAUTION (for storage, operating, rating, soldering, mounting and handling) in this catalog to prevent smoking and/or burning, etc.
• This catalog has only typical specifications. Therefore, please approve our product specifications or transact the approval sheet for product specifications before ordering.

Chip Ferrite Bead SMD Type
Chip EMIFIL® SMD Type
Chip Common Mode Choke Coil SMD Type
Block Type EMIFIL® SMD Type
EMI Suppression Filters Lead Type
Microchip Transformer (Balun) SMD Type

BLM41PG Series 1806/4516 (inch/mm)

1806 size for power lines.

■ Appearance/Dimensions

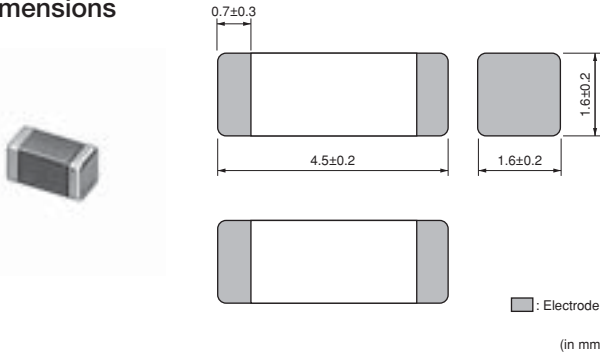

■ Packaging

Code	Packaging	Minimum Quantity
L	ø180mm Embossed Taping	2500
K	ø330mm Embossed Taping	8000
B	Packing in Bulk	1000

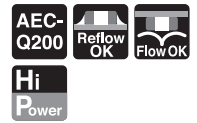

■ Equivalent Circuit



(Resistance element becomes dominant at high frequencies.)

Refer to pages from p.77 to p.80 for mounting information.

■ Rated Value (□: packaging code)

Part Number		Impedance (at 100MHz/20°C)	Rated Current	DC Resistance	Operating Temperature Range
For Infotainment	For Powertrain/Safety				
BLM41PG600SZ1□	BLM41PG600SH1□	60 Ω (Typ.)	6000mA	0.009 Ω max.	-55°C ~ +125°C
BLM41PG750SZ1□	BLM41PG750SH1□	75 Ω (Typ.)	3500mA	0.015 Ω max.	-55°C ~ +125°C
BLM41PG181SZ1□	BLM41PG181SH1□	180 Ω ±25%	3500mA	0.02 Ω max.	-55°C ~ +125°C
BLM41PG471SZ1□	BLM41PG471SH1□	470 Ω ±25%	2000mA	0.05 Ω max.	-55°C ~ +125°C
BLM41PG102SZ1□	BLM41PG102SH1□	1000 Ω ±25%	1500mA	0.09 Ω max.	-55°C ~ +125°C

Number of Circuits: 1

■ Impedance-Frequency Characteristics (Main Items)

BLM41PG_SZ Series (60Ω~75Ω)

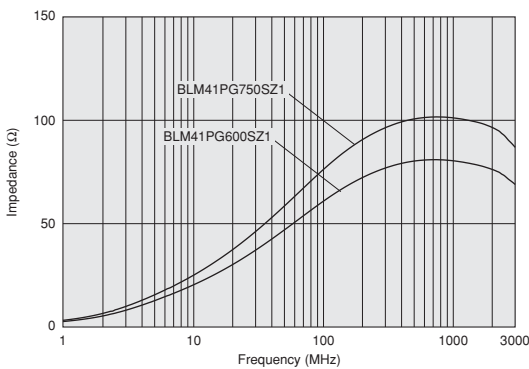

BLM41PG_SZ Series (180Ω~1000Ω)

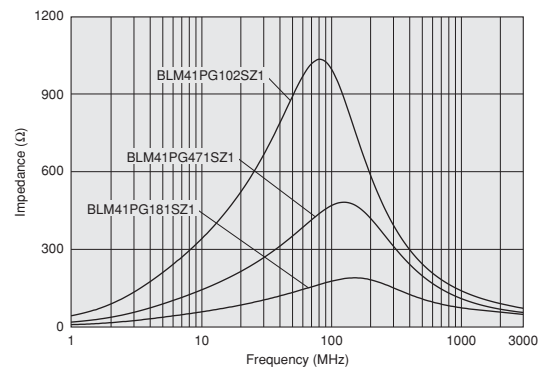

BLM41PG_SH Series (60Ω~180Ω)

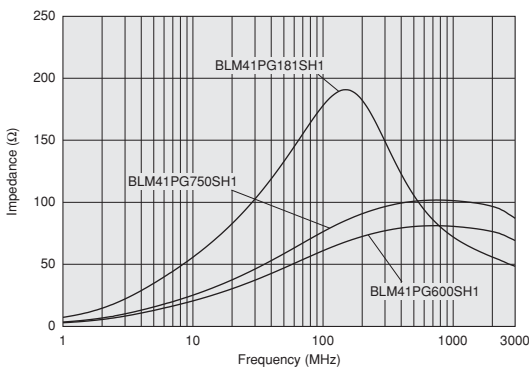

BLM41PG_SH Series (470Ω~1000Ω)

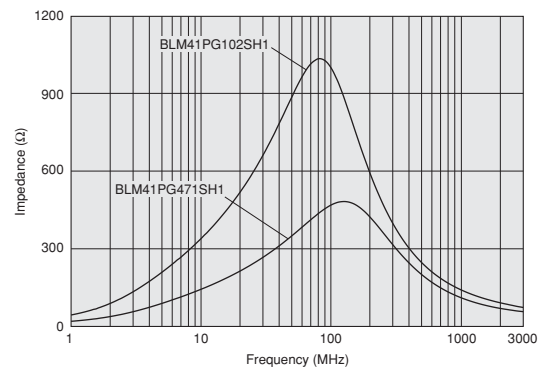

Continued on the following page.

⚠Note • Please read rating and ⚠CAUTION (for storage, operating, rating, soldering, mounting and handling) in this catalog to prevent smoking and/or burning, etc.
• This catalog has only typical specifications. Therefore, please approve our product specifications or transact the approval sheet for product specifications before ordering.

Derating of Rated Current

In operating temperature exceeding +85°C, derating of current is necessary for BLM41PG series.

Please apply the derating curve shown in chart according to the operating temperature.

Derating of Rated Current

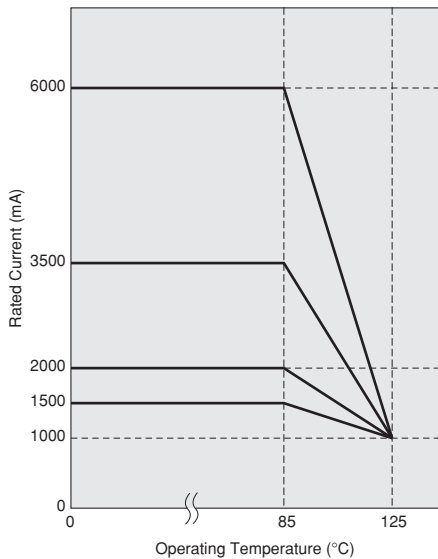

Impedance-Frequency Characteristics

BLM41PG600SZ1/BLM41PG600SH1

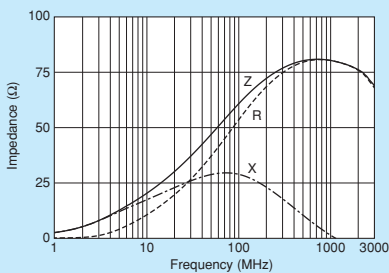

BLM41PG750SZ1/BLM41PG750SH1

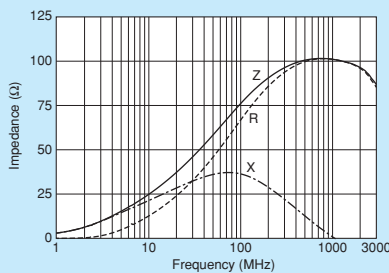

BLM41PG181SZ1/BLM41PG181SH1

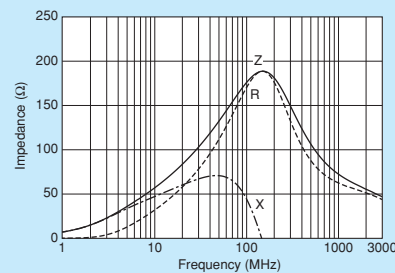

BLM41PG471SZ1/BLM41PG471SH1

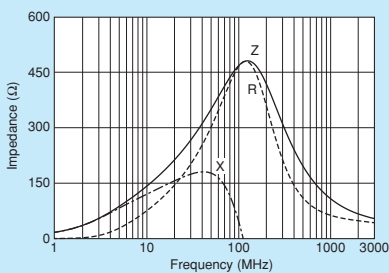

BLM41PG102SZ1/BLM41PG102SH1

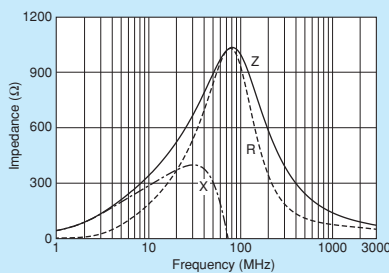

⚠Note • Please read rating and ⚠CAUTION (for storage, operating, rating, soldering, mounting and handling) in this catalog to prevent smoking and/or burning, etc.
• This catalog has only typical specifications. Therefore, please approve our product specifications or transact the approval sheet for product specifications before ordering.

BLE32PN Series 1210/3225 (inch/mm)

10A max., large current chip ferrite bead inductor.

■ Appearance/Dimensions

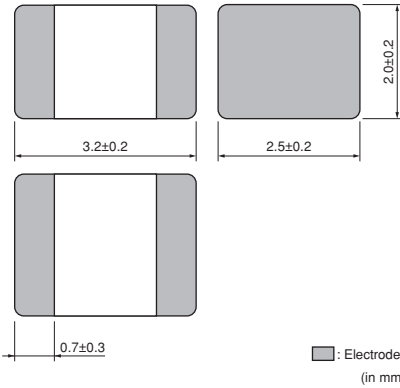

■ Packaging

Code	Packaging	Minimum Quantity
L	ø180mm Embossed Taping	1500
K	ø330mm Embossed Taping	7000
B	Packing in Bulk	1000

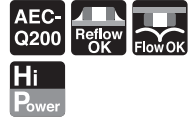

■ Equivalent Circuit

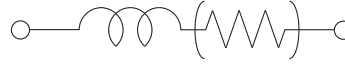

(Resistance element becomes dominant at high frequencies.)

Refer to pages from p.77 to p.80 for mounting information.

■ Rated Value (□: packaging code)

Part Number		Impedance (at 100MHz/20°C)	Rated Current	DC Resistance	Operating Temperature Range
For Infotainment	For Powertrain/Safety				
BLE32PN300SZ1□	—	30Ω ±10Ω	10000mA	1.6mΩ max.	-55°C~+125°C

Number of Circuits: 1

■ Impedance-Frequency Characteristics (Main Items)

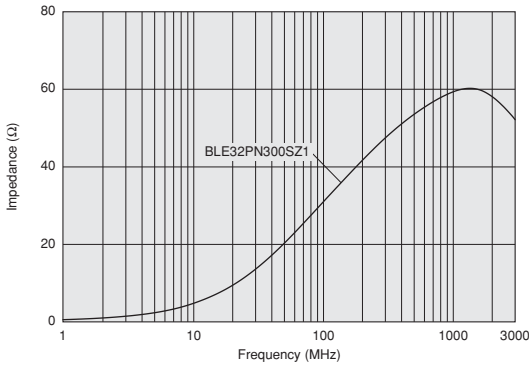

■ Impedance-Frequency Characteristics

BLE32PN300SZ1

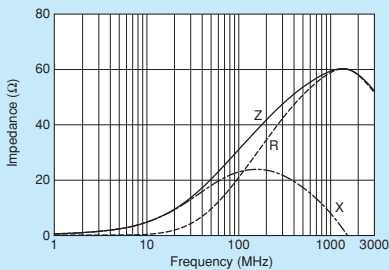

⚠Note • Please read rating and ⚠CAUTION (for storage, operating, rating, soldering, mounting and handling) in this catalog to prevent smoking and/or burning, etc.
• This catalog has only typical specifications. Therefore, please approve our product specifications or transact the approval sheet for product specifications before ordering.

BLM03H Series 0201/0603 (inch/mm)

0201 size for GHz band noise.

Appearance/Dimensions

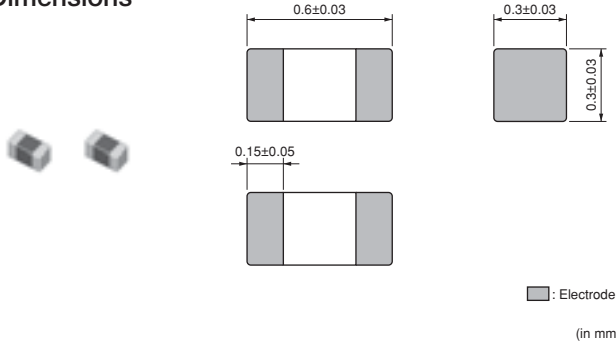

Packaging

Code	Packaging	Minimum Quantity
D	ø180mm Paper Taping	15000
J	ø330mm Paper Taping	50000
B	Packing in Bulk	1000



Equivalent Circuit

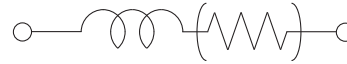

(Resistance element becomes dominant at high frequencies.)

Refer to pages from p.77 to p.80 for mounting information.

Rated Value (□: packaging code)

Part Number		Impedance (at 100MHz/20°C)	Impedance (at 1GHz/20°C)	Rated Current	DC Resistance	Operating Temperature Range
For Infotainment	For Powertrain/Safety					
BLM03HG601SZ1□	—	600 Ω ±25%	1000 Ω ±40%	150mA	1.6 Ω max.	-55°C~+125°C
BLM03HG102SZ1□	—	1000 Ω ±25%	1800 Ω ±40%	125mA	2.6 Ω max.	-55°C~+125°C
BLM03HG122SZ1□	—	1200 Ω ±25%	2000 Ω ±40%	100mA	3.5 Ω max.	-55°C~+125°C
BLM03HD331SZ1□	—	330 Ω ±25%	750 Ω ±40%	200mA	1.0 Ω max.	-55°C~+125°C
BLM03HD471SZ1□	—	470 Ω ±25%	1000 Ω ±40%	175mA	1.3 Ω max.	-55°C~+125°C
BLM03HD601SZ1□	—	600 Ω ±25%	1500 Ω ±40%	150mA	1.7 Ω max.	-55°C~+125°C
BLM03HD102SZ1□	—	1000 Ω ±25%	2300 Ω ±40%	120mA	2.9 Ω max.	-55°C~+125°C
BLM03HB191SZ1□	—	190 Ω ±25%	1150 Ω ±40%	150mA	2.0 Ω max.	-55°C~+125°C

Number of Circuits: 1

Impedance-Frequency Characteristics (Main Items)

BLM03HG Series

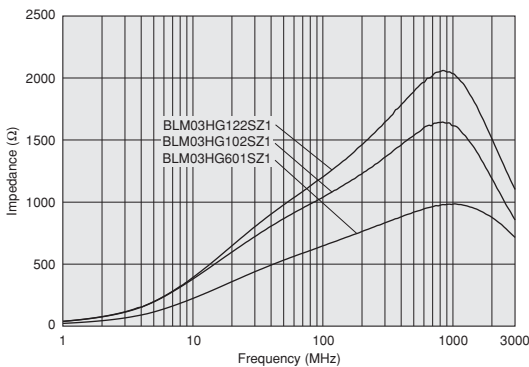

BLM03HD Series

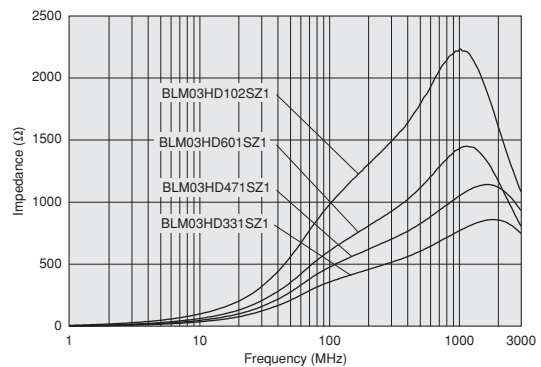

Continued on the following page. ↗

⚠Note • Please read rating and ⚠CAUTION (for storage, operating, rating, soldering, mounting and handling) in this catalog to prevent smoking and/or burning, etc.
• This catalog has only typical specifications. Therefore, please approve our product specifications or transact the approval sheet for product specifications before ordering.

■ Impedance-Frequency Characteristics (Main Items)

BLM03HB Series

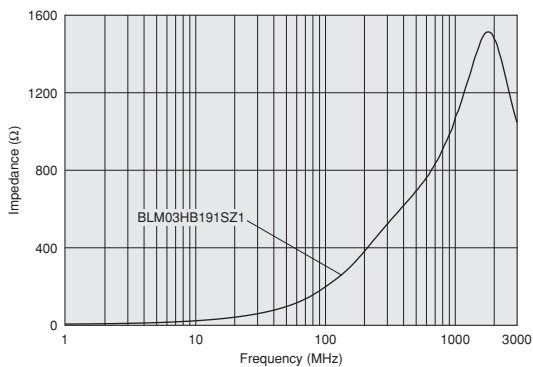

■ Impedance-Frequency Characteristics

BLM03HG601SZ1

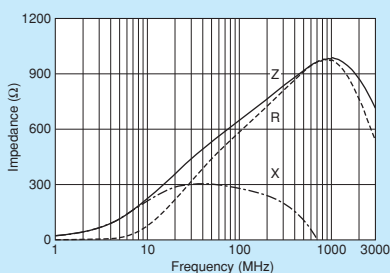

BLM03HG102SZ1

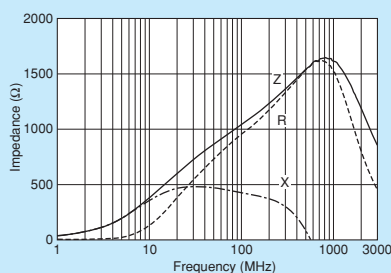

BLM03HG122SZ1

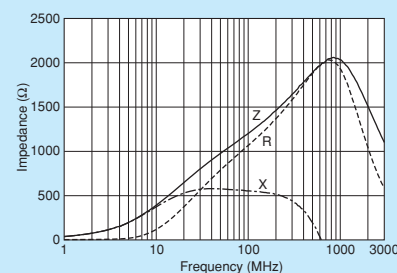

BLM03HD331SZ1

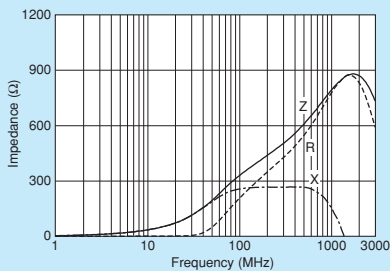

BLM03HD471SZ1

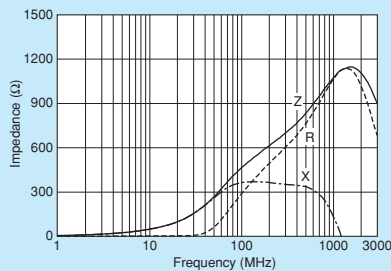

BLM03HD601SZ1

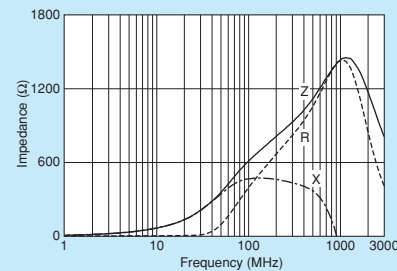

BLM03HD102SZ1

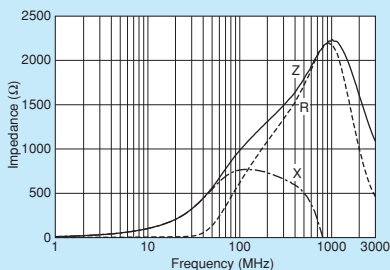

BLM03HB191SZ1

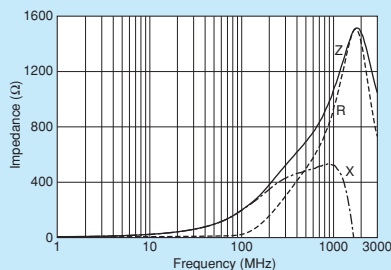

⚠Note • Please read rating and ⚠CAUTION (for storage, operating, rating, soldering, mounting and handling) in this catalog to prevent smoking and/or burning, etc.
 • This catalog has only typical specifications. Therefore, please approve our product specifications or transact the approval sheet for product specifications before ordering.

SMD Type
Chip Ferrite Bead

SMD Type
Chip EMIFIL®

SMD Type
Chip Common Mode Choke Coil

SMD Type
Block Type EMIFIL®

Lead Type
EMI Suppression Filters

SMD Type
Microchip Transformer (Balun)

BLM03E Series 0201/0603 (inch/mm)

For GHz band noise and capable of large current.

■ Appearance/Dimensions

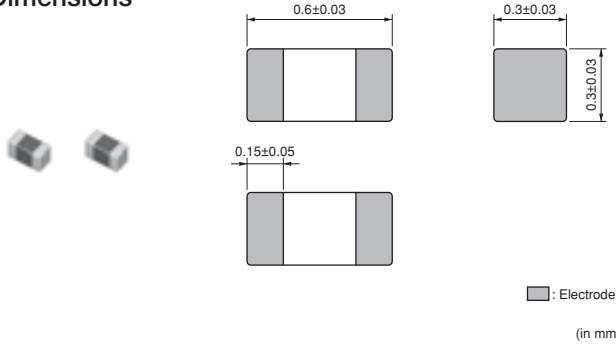

■ Packaging

Code	Packaging	Minimum Quantity
D	ø180mm Paper Taping	15000
J	ø330mm Paper Taping	50000
B	Packing in Bulk	1000



■ Equivalent Circuit

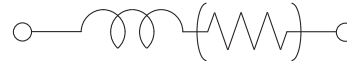

(Resistance element becomes dominant at high frequencies.)

Refer to pages from p.77 to p.80 for mounting information.

■ Rated Value (□: packaging code)

Part Number		Impedance (at 100MHz/20°C)	Impedance (at 1GHz/20°C)	Rated Current	DC Resistance	Operating Temperature Range
For Infotainment	For Powertrain/Safety					
BLM03EB250SZ1□	—	25Ω ±25%	105Ω ±40%	600mA	0.26Ω max.	-55°C~+125°C
BLM03EB500SZ1□	—	50Ω ±25%	255Ω ±40%	400mA	0.58Ω max.	-55°C~+125°C

Number of Circuits: 1

■ Impedance-Frequency Characteristics (Main Items)

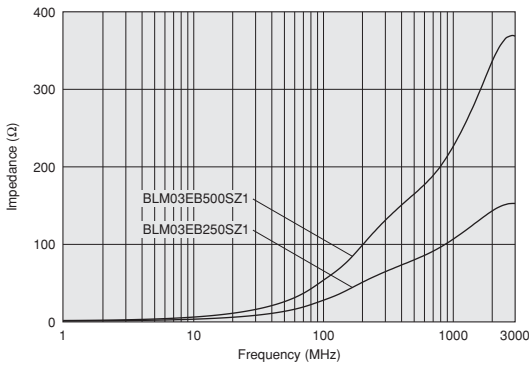

■ Derating of Rated Current

In operating temperature exceeding +85°C, derating of current is necessary for BLM03E series.

Please apply the derating curve shown in chart according to the operating temperature.

Derating of Rated Current

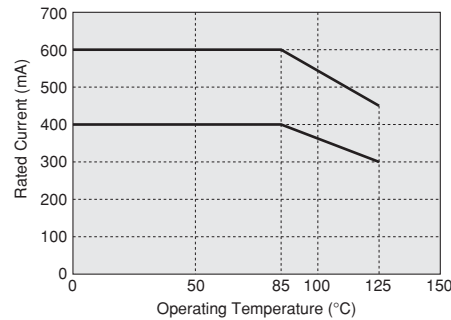

■ Impedance-Frequency Characteristics

BLM03EB250SZ1

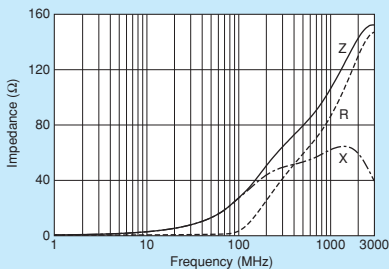

BLM03EB500SZ1

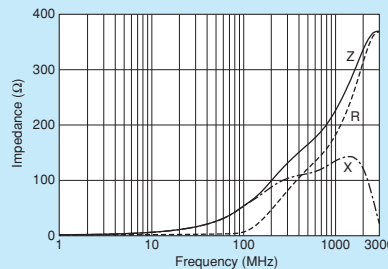

△Note • Please read rating and △CAUTION (for storage, operating, rating, soldering, mounting and handling) in this catalog to prevent smoking and/or burning, etc.
• This catalog has only typical specifications. Therefore, please approve our product specifications or transact the approval sheet for product specifications before ordering.

BLM15H Series 0402/1005 (inch/mm)

0402 size for GHz band noise.

■ Appearance/Dimensions

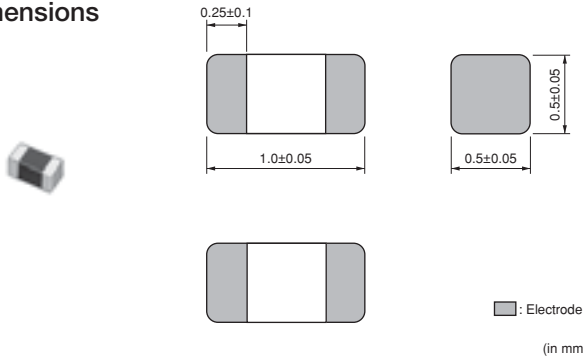

■ Packaging

Code	Packaging	Minimum Quantity
D	ø180mm Paper Taping	15000
J	ø330mm Paper Taping	50000
B	Packing in Bulk	1000



■ Equivalent Circuit

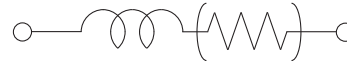

(Resistance element becomes dominant at high frequencies.)

Refer to pages from p.77 to p.80 for mounting information.

■ Rated Value (□: packaging code)

Part Number		Impedance (at 100MHz/20°C)	Impedance (at 1GHz/20°C)	Rated Current	DC Resistance	Operating Temperature Range
For Infotainment	For Powertrain/Safety					
BLM15HG601SZ1□	BLM15HG601SH1□	600 Ω ±25%	1000 Ω ±40%	300mA	0.7 Ω max.	-55°C~+125°C
BLM15HG102SZ1□	BLM15HG102SH1□	1000 Ω ±25%	1400 Ω ±40%	250mA	1.1 Ω max.	-55°C~+125°C
BLM15HD601SZ1□	BLM15HD601SH1□	600 Ω ±25%	1400 Ω ±40%	300mA	0.85 Ω max.	-55°C~+125°C
BLM15HD102SZ1□	BLM15HD102SH1□	1000 Ω ±25%	2000 Ω ±40%	250mA	1.25 Ω max.	-55°C~+125°C
BLM15HD182SZ1□	BLM15HD182SH1□	1800 Ω ±25%	2700 Ω ±40%	200mA	2.2 Ω max.	-55°C~+125°C
BLM15HB121SZ1□	—	120 Ω ±25%	500 Ω ±40%	300mA	0.7 Ω max.	-55°C~+125°C
BLM15HB221SZ1□	—	220 Ω ±25%	900 Ω ±40%	250mA	1.0 Ω max.	-55°C~+125°C

Number of Circuits: 1

■ Impedance-Frequency Characteristics (Main Items)

BLM15HG_SZ Series (For General Signal Lines)

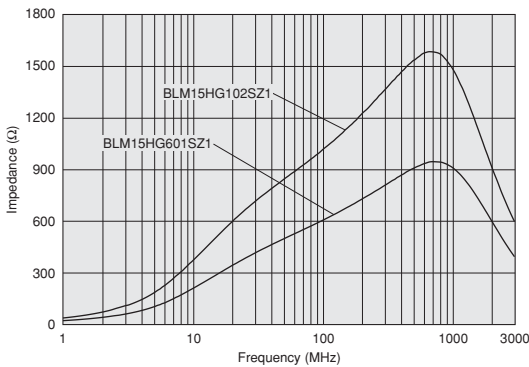

BLM15HG_SH Series

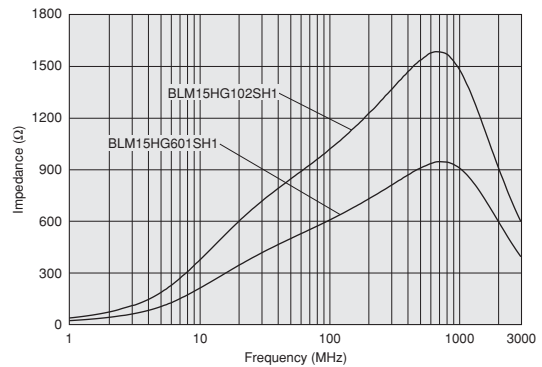

BLM15HD_SZ Series (For High Speed Signal Lines)

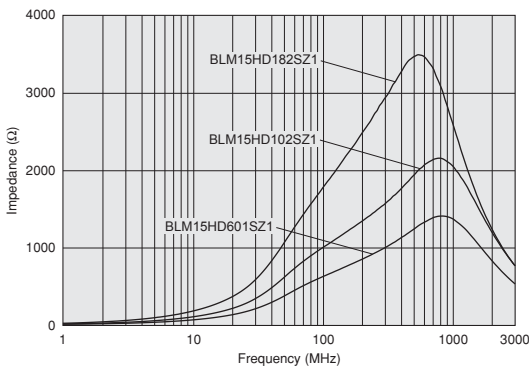

BLM15HD_SH Series

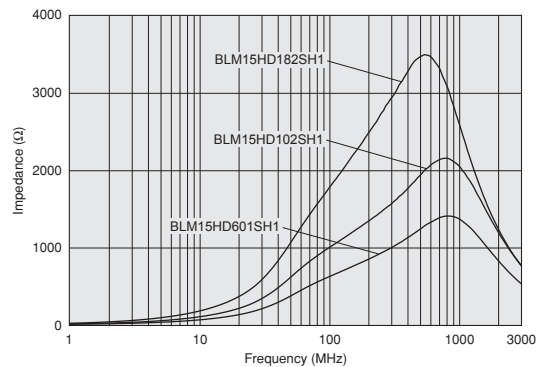

Continued on the following page.

△Note • Please read rating and △CAUTION (for storage, operating, rating, soldering, mounting and handling) in this catalog to prevent smoking and/or burning, etc.
• This catalog has only typical specifications. Therefore, please approve our product specifications or transact the approval sheet for product specifications before ordering.

■ Impedance-Frequency Characteristics (Main Items)

BLM15HB_SZ Series (For High Speed Signal Lines)

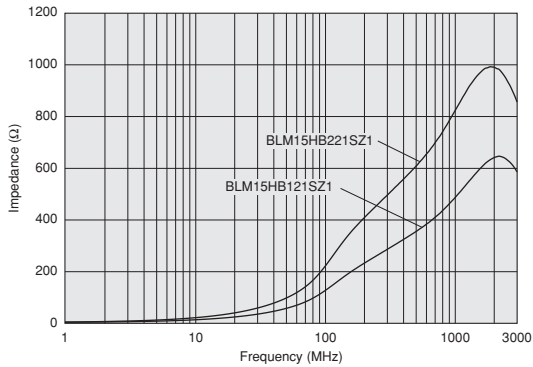

■ Impedance-Frequency Characteristics

BLM15HG601SZ1/BLM15HG601SH1

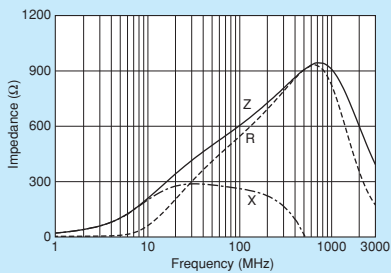

BLM15HG102SZ1/BLM15HG102SH1

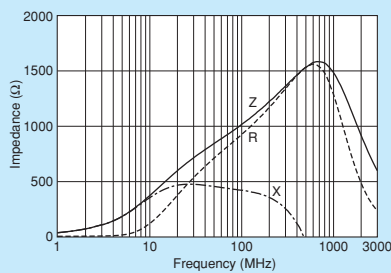

BLM15HD601SZ1/BLM15HD601SH1

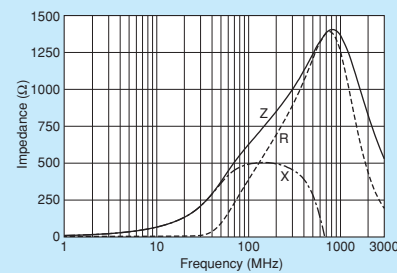

BLM15HD102SZ1/BLM15HD102SH1

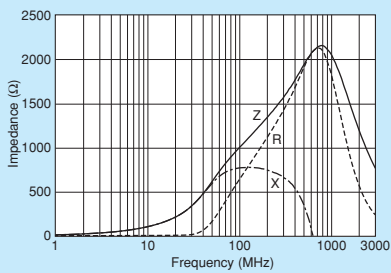

BLM15HD182SZ1/BLM15HD182SH1

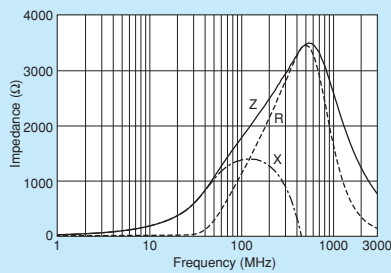

BLM15HB121SZ1

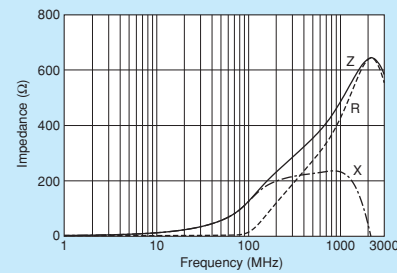

BLM15HB221SZ1

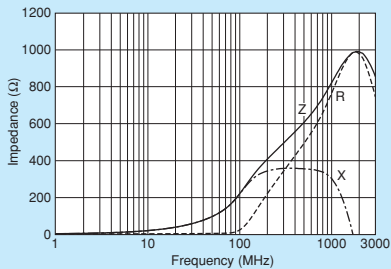

⚠Note • Please read rating and ⚠CAUTION (for storage, operating, rating, soldering, mounting and handling) in this catalog to prevent smoking and/or burning, etc.
• This catalog has only typical specifications. Therefore, please approve our product specifications or transact the approval sheet for product specifications before ordering.

BLM15EG Series 0402/1005 (inch/mm)

For GHz band noise, also capable to large current.

Appearance/Dimensions

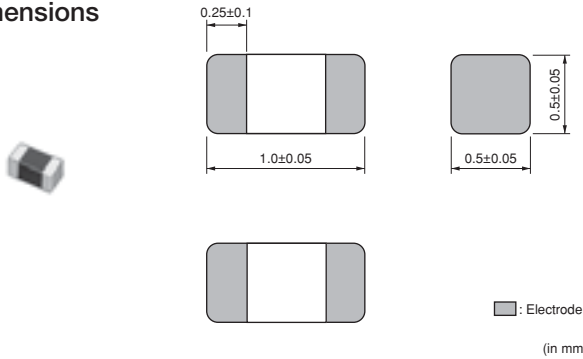

Packaging

Code	Packaging	Minimum Quantity
D	ø180mm Paper Taping	4000
J	ø330mm Paper Taping	10000
B	Packing in Bulk	1000



Equivalent Circuit

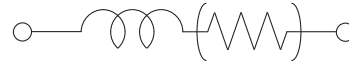

(Resistance element becomes dominant at high frequencies.)

Refer to pages from p.77 to p.80 for mounting information.

Rated Value (□: packaging code)

Part Number		Impedance (at 100MHz/20°C)	Impedance (at 1GHz/20°C)	Rated Current	DC Resistance	Operating Temperature Range
For Infotainment	For Powertrain/Safety					
BLM15EG121SZ1□	—	120 Ω ±25%	145 Ω (Typ.)	1500mA	0.095 Ω max.	-55°C~+125°C
BLM15EG221SZ1□	—	220 Ω ±25%	270 Ω (Typ.)	700mA	0.28 Ω max.	-55°C~+125°C

Number of Circuits: 1

Impedance-Frequency Characteristics (Main Items)

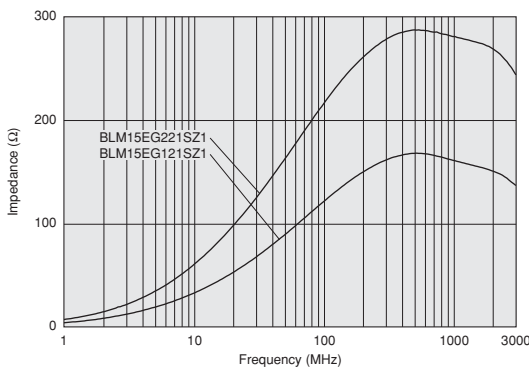

Derating of Rated Current

In operating temperature exceeding +85°C, derating of current is necessary for BLM15E series.

Please apply the derating curve shown in chart according to the operating temperature.

Derating of Rated Current

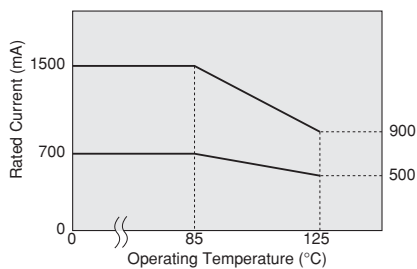

Impedance-Frequency Characteristics

BLM15EG121SZ1

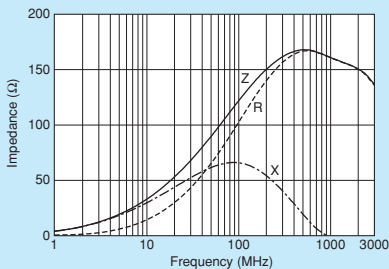

BLM15EG221SZ1

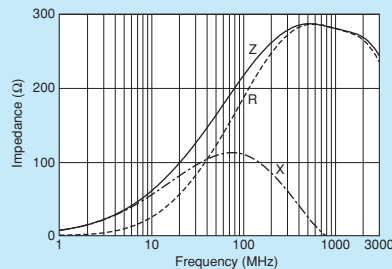

Note • Please read rating and CAUTION (for storage, operating, rating, soldering, mounting and handling) in this catalog to prevent smoking and/or burning, etc.
• This catalog has only typical specifications. Therefore, please approve our product specifications or transact the approval sheet for product specifications before ordering.

BLM15G Series 0402/1005 (inch/mm)

Available up to high-GHz band noise.

Appearance/Dimensions

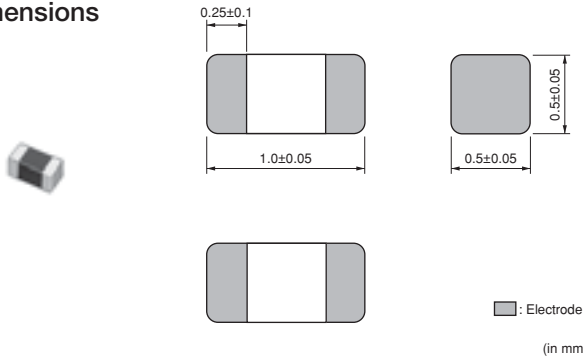

Packaging

Code	Packaging	Minimum Quantity
D	ø180mm Paper Taping	10000
J	ø330mm Paper Taping	50000
B	Packing in Bulk	1000



Equivalent Circuit

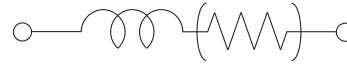

(Resistance element becomes dominant at high frequencies.)

Refer to pages from p.77 to p.80 for mounting information.

Rated Value (□: packaging code)

Part Number		Impedance (at 100MHz/20°C)	Impedance (at 1GHz/20°C)	Rated Current	DC Resistance	Operating Temperature Range
For Infotainment	For Powertrain/Safety					
BLM15GG221SZ1□	—	220 Ω ±25%	600 Ω ±40%	300mA	0.7 Ω max.	-55°C ~ +125°C
BLM15GG471SZ1□	—	470 Ω ±25%	1200 Ω ±40%	200mA	1.3 Ω max.	-55°C ~ +125°C
BLM15GA750SZ1□	—	75 Ω ±25%	1000 Ω ±40%	200mA	1.3 Ω max.	-55°C ~ +125°C

Number of Circuits: 1

Impedance-Frequency Characteristics (Main Items)

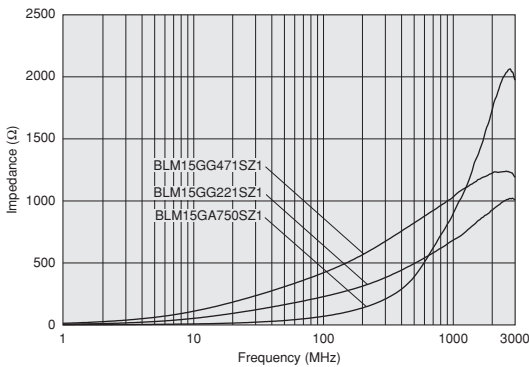

Impedance-Frequency Characteristics

BLM15GG221SZ1

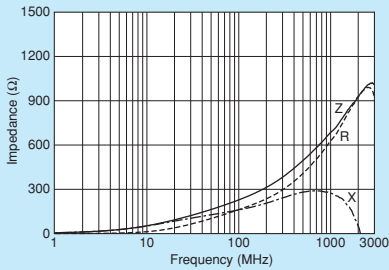

BLM15GG471SZ1

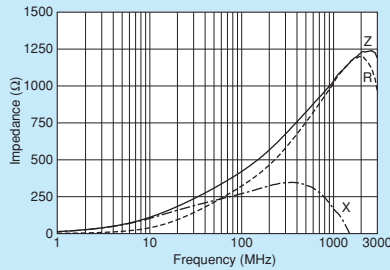

BLM15GA750SZ1

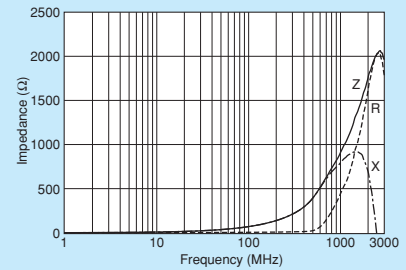

△Note • Please read rating and △CAUTION (for storage, operating, rating, soldering, mounting and handling) in this catalog to prevent smoking and/or burning, etc.
• This catalog has only typical specifications. Therefore, please approve our product specifications or transact the approval sheet for product specifications before ordering.

BLM18H Series 0603/1608 (inch/mm)

0603 size for GHz band noise. BLM18HE also supports power lines.

Appearance/Dimensions

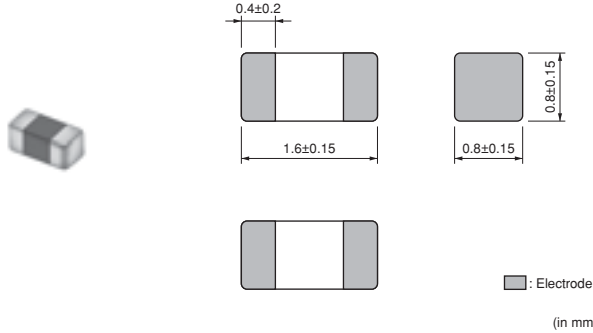

Packaging

Code	Packaging	Minimum Quantity
D	ø180mm Paper Taping	4000
J	ø330mm Paper Taping	10000
B	Packing in Bulk	1000

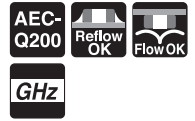

Equivalent Circuit

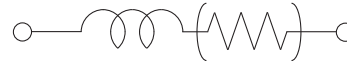

(Resistance element becomes dominant at high frequencies.)

Refer to pages from p.77 to p.80 for mounting information.

Rated Value (□: packaging code)

Part Number		Impedance (at 100MHz/20°C)	Impedance (at 1GHz/20°C)	Rated Current	DC Resistance	Operating Temperature Range
For Infotainment	For Powertrain/Safety					
BLM18HG471SZ1□	BLM18HG471SH1□	470 Ω ±25%	600 Ω (Typ.)	200mA	0.85 Ω max.	-55°C~+125°C
BLM18HG601SZ1□	BLM18HG601SH1□	600 Ω ±25%	700 Ω (Typ.)	200mA	1.00 Ω max.	-55°C~+125°C
BLM18HG102SZ1□	BLM18HG102SH1□	1000 Ω ±25%	1000 Ω (Typ.)	100mA	1.60 Ω max.	-55°C~+125°C
BLM18HE601SZ1□	—	600 Ω ±25%	600 Ω (Typ.)	800mA	0.25 Ω max.	-55°C~+125°C
BLM18HE102SZ1□	—	1000 Ω ±25%	1000 Ω (Typ.)	600mA	0.35 Ω max.	-55°C~+125°C
BLM18HE152SZ1□	—	1500 Ω ±25%	1500 Ω (Typ.)	500mA	0.50 Ω max.	-55°C~+125°C
BLM18HD471SZ1□	BLM18HD471SH1□	470 Ω ±25%	1000 Ω (Typ.)	100mA	1.20 Ω max.	-55°C~+125°C
BLM18HD601SZ1□	BLM18HD601SH1□	600 Ω ±25%	1200 Ω (Typ.)	100mA	1.50 Ω max.	-55°C~+125°C
BLM18HD102SZ1□	BLM18HD102SH1□	1000 Ω ±25%	1700 Ω (Typ.)	50mA	1.80 Ω max.	-55°C~+125°C
BLM18HB121SZ1□	—	120 Ω ±25%	500 Ω ±40%	200mA	0.50 Ω max.	-55°C~+125°C
BLM18HB221SZ1□	—	220 Ω ±25%	1100 Ω ±40%	100mA	0.80 Ω max.	-55°C~+125°C
BLM18HB331SZ1□	—	330 Ω ±25%	1600 Ω ±40%	50mA	1.20 Ω max.	-55°C~+125°C

Number of Circuits: 1

Impedance-Frequency Characteristics (Main Items)

BLM18HG_SZ Series (For General Signal Lines)

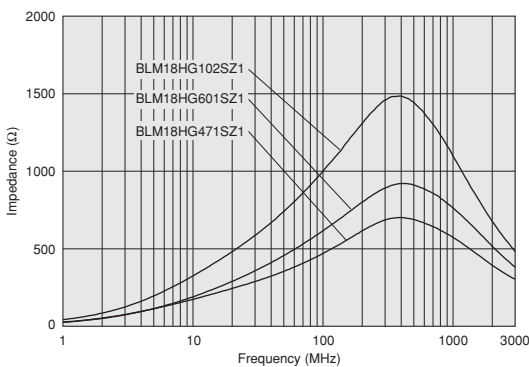

BLM18HG_SH Series (For General Signal Lines)

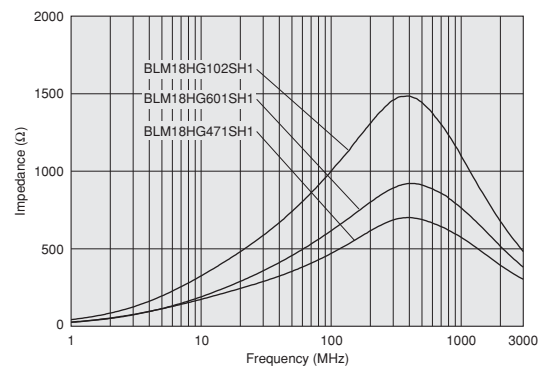

Continued on the following page.

△Note • Please read rating and △CAUTION (for storage, operating, rating, soldering, mounting and handling) in this catalog to prevent smoking and/or burning, etc.
• This catalog has only typical specifications. Therefore, please approve our product specifications or transact the approval sheet for product specifications before ordering.

Chip Ferrite Bead
SMD Type

Chip EMIFIL®
SMD Type

Chip Common Mode Choke Coil
SMD Type

Block Type EMIFIL®
SMD Type

EMI Suppression Filters
Lead Type

Microchip Transformer (Balun)
SMD Type

■ Impedance-Frequency Characteristics (Main Items)

BLM18HE_SZ Series (For High Speed Signal Lines)

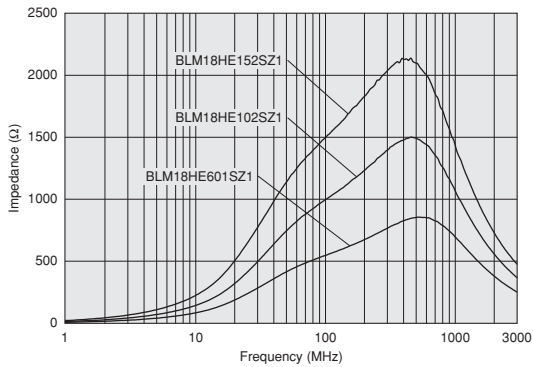

BLM18HD_SZ Series (For High Speed Signal Lines)

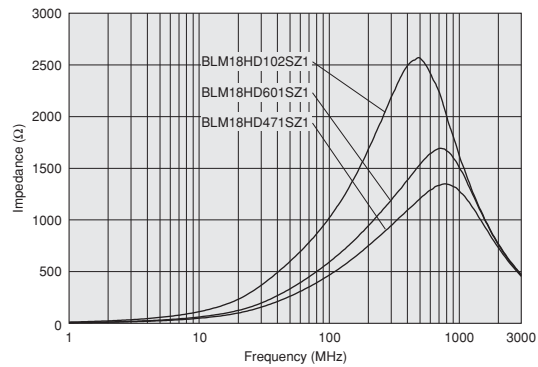

BLM18HD_SH Series (For High Speed Signal Lines)

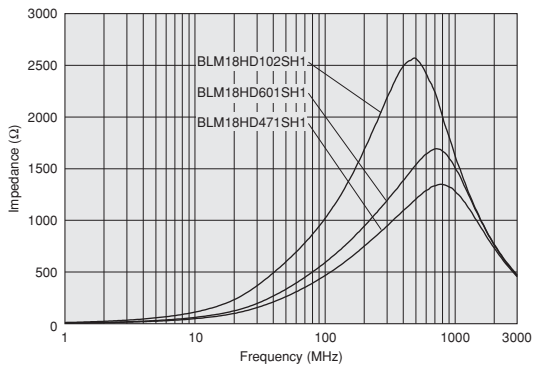

BLM18HB_SZ Series (For High Speed Signal Lines)

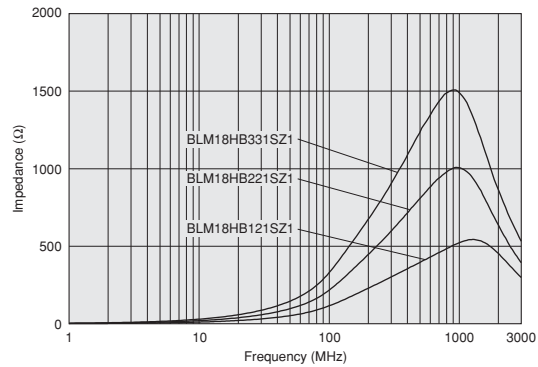

■ Derating of Rated Current

In operating temperature exceeding +85°C, derating of current is necessary for BLM18HE series.

Please apply the derating curve shown in chart according to the operating temperature.

Derating of Rated Current

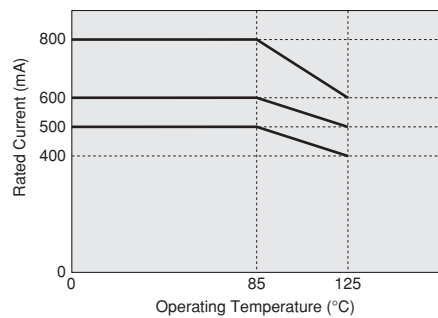

Continued on the following page.

△Note • Please read rating and △CAUTION (for storage, operating, rating, soldering, mounting and handling) in this catalog to prevent smoking and/or burning, etc.
• This catalog has only typical specifications. Therefore, please approve our product specifications or transact the approval sheet for product specifications before ordering.

■ Impedance-Frequency Characteristics

BLM18HG471SZ1/BLM18HG471SH1

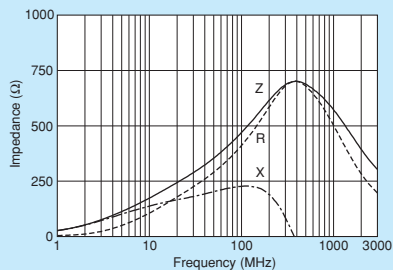

BLM18HG601SZ1/BLM18HG601SH1

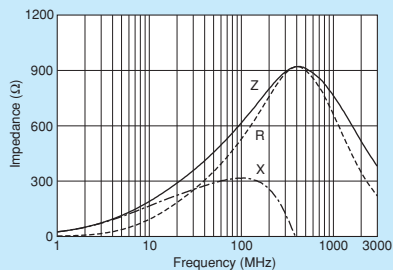

BLM18HG102SZ1/BLM18HG102SH1

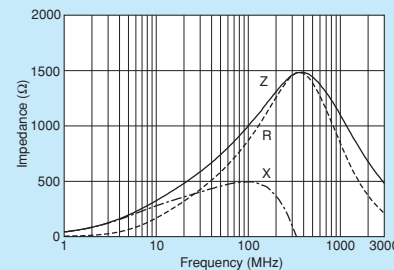

BLM18HE601SZ1

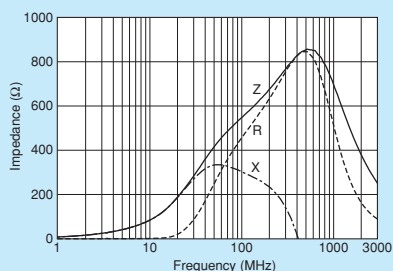

BLM18HE102SZ1

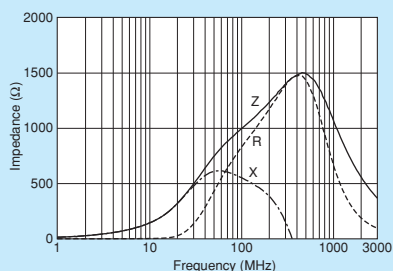

BLM18HE152SZ1

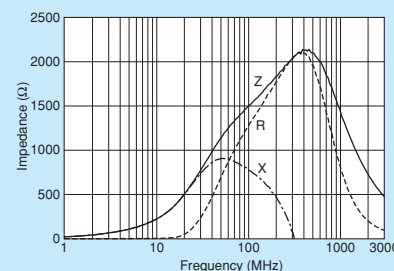

BLM18HD471SZ1/BLM18HD471SH1

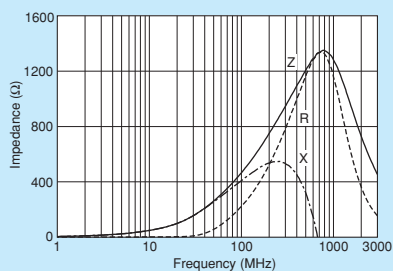

BLM18HD601SZ1/BLM18HD601SH1

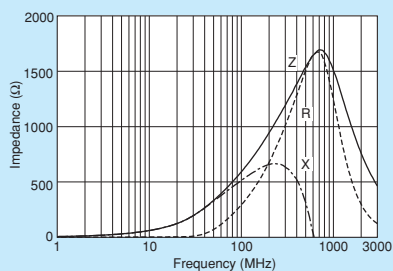

BLM18HD102SZ1/BLM18HD102SH1

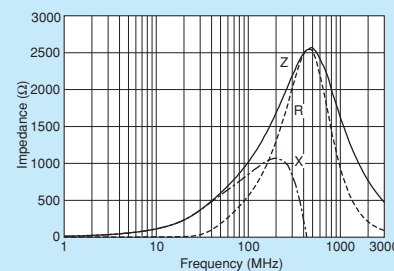

BLM18HB121SZ1

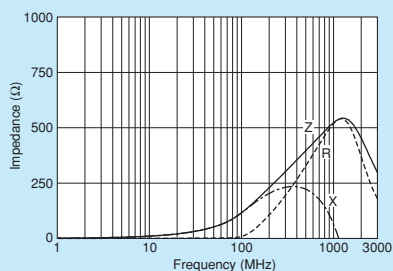

BLM18HB221SZ1

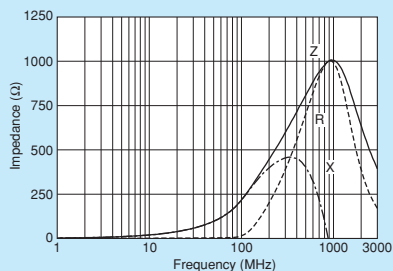

BLM18HB331SZ1

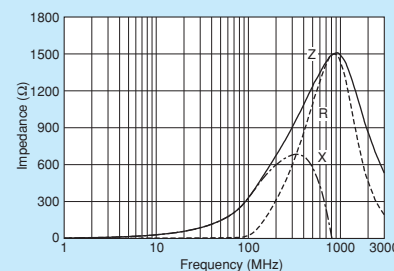

Note • Please read rating and **CAUTION** (for storage, operating, rating, soldering, mounting and handling) in this catalog to prevent smoking and/or burning, etc.
 • This catalog has only typical specifications. Therefore, please approve our product specifications or transact the approval sheet for product specifications before ordering.

SMD Type
Chip Ferrite Bead

SMD Type
Chip EMIFIL®

SMD Type
Chip Common Mode Choke Coil

SMD Type
Block Type EMIFIL®

Lead Type
EMI Suppression Filter

SMD Type
Microchip Transformer (Balun)

BLM18EG Series 0603/1608 (inch/mm)

For GHz band noise, also capable to large current.

Appearance/Dimensions

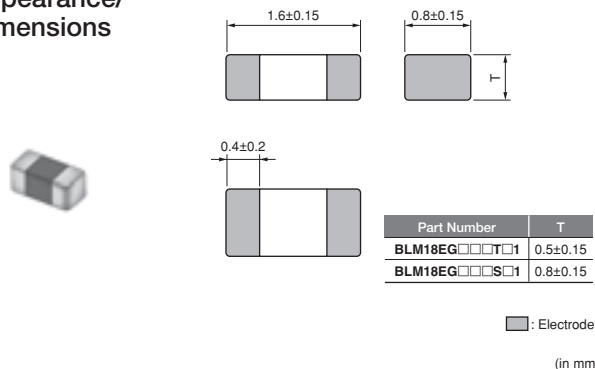

Packaging

Code	Packaging	Minimum Quantity
D	ø180mm Paper Taping	4000
J	ø330mm Paper Taping	10000
B	Packing in Bulk	1000



Equivalent Circuit



(Resistance element becomes dominant at high frequencies.)

Refer to pages from p.77 to p.80 for mounting information.

Rated Value (□: packaging code)

Part Number		Impedance (at 100MHz/20°C)	Impedance (at 1GHz/20°C)	Rated Current	DC Resistance	Operating Temperature Range
For Infotainment	For Powertrain/Safety					
BLM18EG101TZ1□	BLM18EG101TH1□	100 Ω ±25%	140 Ω (Typ.)	2000mA	0.045 Ω max.	-55°C~+125°C
BLM18EG121SZ1□	BLM18EG121SH1□	120 Ω ±25%	145 Ω (Typ.)	2000mA	0.04 Ω max.	-55°C~+125°C
—	BLM18EG181SH1□	180 Ω ±25%	260 Ω (Typ.)	2000mA	0.05 Ω max.	-55°C~+125°C
BLM18EG221SZ1□	—	220 Ω ±25%	260 Ω (Typ.)	2000mA	0.05 Ω max.	-55°C~+125°C
BLM18EG221TZ1□	BLM18EG221TH1□	220 Ω ±25%	300 Ω (Typ.)	1000mA	0.15 Ω max.	-55°C~+125°C
BLM18EG331TZ1□	BLM18EG331TH1□	330 Ω ±25%	450 Ω (Typ.)	500mA	0.21 Ω max.	-55°C~+125°C
BLM18EG391TZ1□	BLM18EG391TH1□	390 Ω ±25%	520 Ω (Typ.)	500mA	0.30 Ω max.	-55°C~+125°C
BLM18EG471SZ1□	BLM18EG471SH1□	470 Ω ±25%	550 Ω (Typ.)	500mA	0.21 Ω max.	-55°C~+125°C
BLM18EG601SZ1□	BLM18EG601SH1□	600 Ω ±25%	700 Ω (Typ.)	500mA	0.35 Ω max.	-55°C~+125°C

Number of Circuits: 1

Impedance-Frequency Characteristics (Main Items)

BLM18EG_TZ1 Series

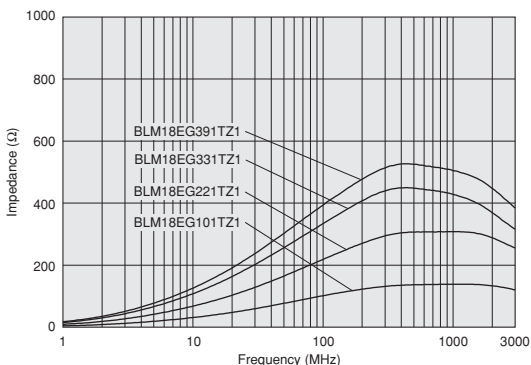

BLM18EG_TH1 Series

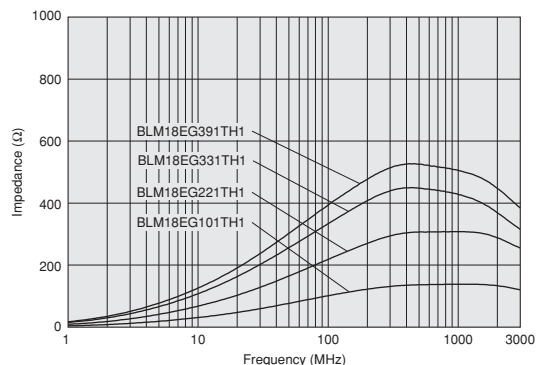

Continued on the following page. ↗

Note • Please read rating and CAUTION (for storage, operating, rating, soldering, mounting and handling) in this catalog to prevent smoking and/or burning, etc.
• This catalog has only typical specifications. Therefore, please approve our product specifications or transact the approval sheet for product specifications before ordering.

■ Impedance-Frequency Characteristics (Main Items)

BLM18EG_SZ1 Series

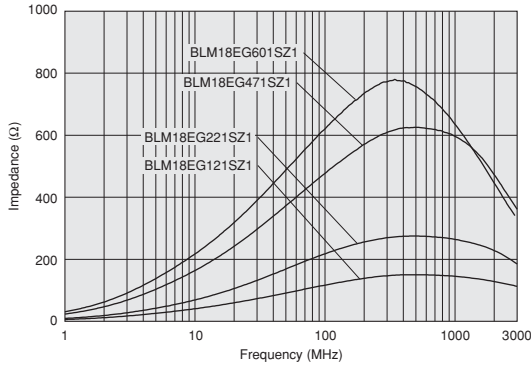

BLM18EG_SH1 Series

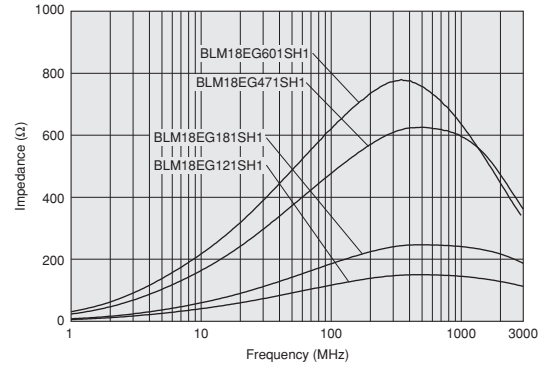

■ Derating of Rated Current

In operating temperature exceeding +85°C, derating of current is necessary for BLM18EG series.

Please apply the derating curve shown in chart according to the operating temperature.

Derating of Rated Current

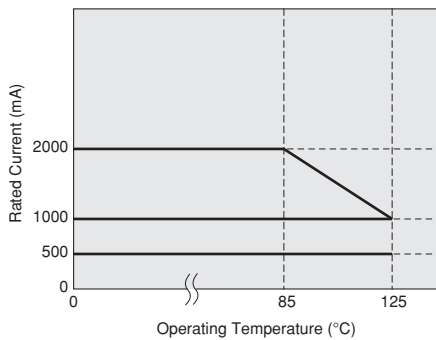

■ Impedance-Frequency Characteristics

BLM18EG101TZ1/BLM18EG101TH1

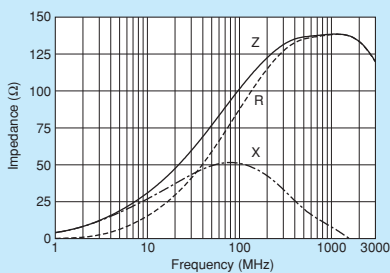

BLM18EG121SZ1/BLM18EG121SH1

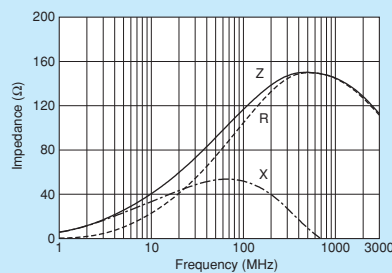

BLM18EG181SH1

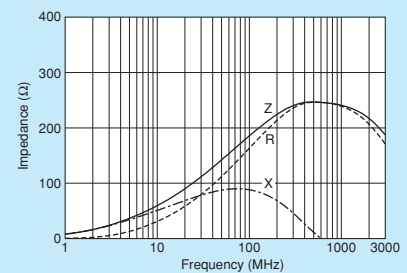

Continued on the following page.

⚠Note • Please read rating and ⚠CAUTION (for storage, operating, rating, soldering, mounting and handling) in this catalog to prevent smoking and/or burning, etc.
• This catalog has only typical specifications. Therefore, please approve our product specifications or transact the approval sheet for product specifications before ordering.

■ Impedance-Frequency Characteristics

BLM18EG221SZ1

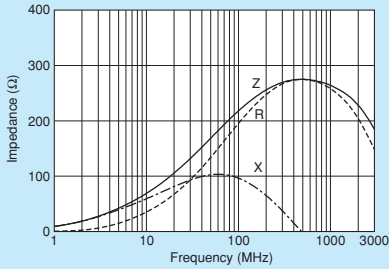

BLM18EG221TZ1/BLM18EG221TH1

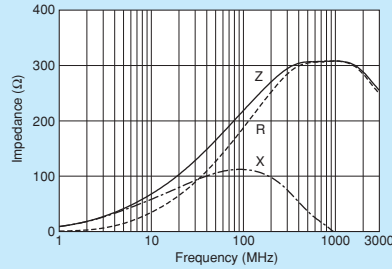

BLM18EG331TZ1/BLM18EG331TH1

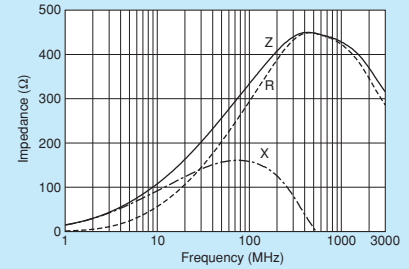

BLM18EG391TZ1/BLM18EG391TH1

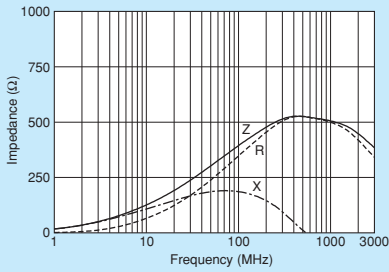

BLM18EG471SZ1/BLM18EG471SH1

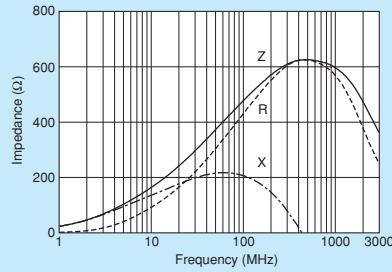

BLM18EG601SZ1/BLM18EG601SH1

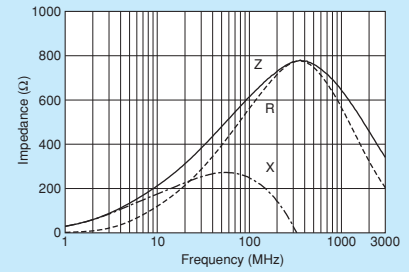

⚠Note • Please read rating and ⚠CAUTION (for storage, operating, rating, soldering, mounting and handling) in this catalog to prevent smoking and/or burning, etc.
 • This catalog has only typical specifications. Therefore, please approve our product specifications or transact the approval sheet for product specifications before ordering.

Chip Ferrite Bead SMD Type
 Chip EMIFIL® SMD Type
 Chip Common Mode Choke Coil SMD Type
 Block Type EMIFIL® SMD Type
 EMI Suppression Filters Lead Type
 Microchip Transformer (Balun) SMD Type

BLM18GG Series 0603/1608 (inch/mm)

Available up to high-GHz band noise.

Appearance/Dimensions

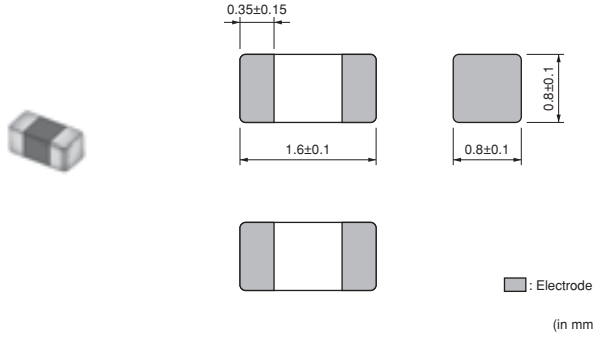

Packaging

Code	Packaging	Minimum Quantity
D	ø180mm Paper Taping	4000
J	ø330mm Paper Taping	10000
B	Packing in Bulk	1000



Equivalent Circuit

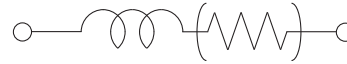

(Resistance element becomes dominant at high frequencies.)

Refer to pages from p.77 to p.80 for mounting information.

Rated Value (□: packaging code)

Part Number		Impedance (at 100MHz/20°C)	Impedance (at 1GHz/20°C)	Rated Current	DC Resistance	Operating Temperature Range
For Infotainment	For Powertrain/Safety					
BLM18GG471SZ1□	—	470 Ω ±25%	1800 Ω ±30%	200mA	1.0 Ω ±0.3 Ω	-55°C~+125°C

Number of Circuits: 1

Impedance-Frequency Characteristics (Main Items)

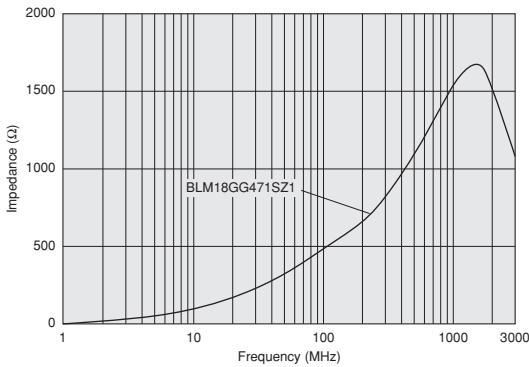

Impedance-Frequency Characteristics

BLM18GG471SZ1

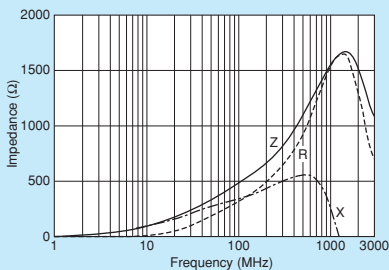

⚠Note • Please read rating and ⚠CAUTION (for storage, operating, rating, soldering, mounting and handling) in this catalog to prevent smoking and/or burning, etc.
• This catalog has only typical specifications. Therefore, please approve our product specifications or transact the approval sheet for product specifications before ordering.

⚠ Caution

● Rating

1. About the Rated Current
Do not use products beyond the rated current as this may create excessive heat and deteriorate the insulation resistance.
2. About the Excessive Surge Current
Excessive surge current (pulse current or rush current) than specified rated current applied to the product may cause a critical failure, such as an open circuit, burnout caused by excessive temperature rise. Please contact us in advance in case of applying the surge current.

● Soldering and Mounting

- Self-heating
Please pay special attention when mounting chip ferrite beads BLM_AX/P/K/S series bead inductor BLE series in close proximity to other products that radiate heat.
The heat generated by other products may deteriorate the insulation resistance and cause excessive heat in this component.

Notice

● Storage and Operating Conditions

<Operating Environment>

Do not use products in a chemical atmosphere such as chlorine gas, acid or sulfide gas.

Do not use products in the environment close to the organic solvent.

<Storage and Handling Requirements>

1. Storage Period
BLM15E/15H/15G series should be used within 12 months, the other series should be used within 6 months.
Solderability should be checked if this period is exceeded.
2. Storage Conditions
 - (1) Storage temperature: -10 to +40°C
Relative humidity: 15 to 85%
Avoid sudden changes in temperature and humidity.
 - (2) Do not store products in a chemical atmosphere such as chlorine gas, acid or sulfide gas.

● Notice (Soldering and Mounting)

1. Cleaning
Failure and degradation of a product are caused by the cleaning method. When you clean in conditions that are not in mounting information, please contact Murata engineering.
2. Soldering
Reliability decreases with improper soldering methods. Please solder by the standard soldering conditions shown in mounting information.
3. Mounting on-board with Conductive Glue
BLM18AG_WH is designed for conductive glue mounting method. Please refer to Mounting information.

4. Other

Noise suppression levels resulting from Murata's EMI suppression filters EMIFIL[®] may vary, depending on the circuits and ICs used, type of noise, mounting pattern, mounting location, and other operating conditions. Be sure to check and confirm in advance the noise suppression effect of each filter, in actual circuits, etc. before applying the filter in a commercial-purpose equipment design.

● Handling

1. Resin Coating
Using resin for coating/molding products may affect the products performance.
So please pay careful attention in selecting resin.
Prior to use, please make the reliability evaluation with the product mounted in your application set.
2. Handling of a Substrate
After mounting products on a substrate, do not apply any stress to the product caused by bending or twisting to the substrate when cropping the substrate, inserting and removing a connector from the substrate or tightening screw to the substrate.
Excessive mechanical stress may cause cracking in the Product.

Bending

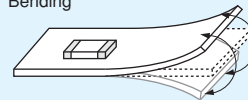

Twisting

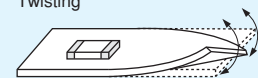

⚠ Note • Please read rating and ⚠ CAUTION (for storage, operating, rating, soldering, mounting and handling) in this catalog to prevent smoking and/or burning, etc.
• This catalog has only typical specifications. Therefore, please approve our product specifications or transact the approval sheet for product specifications before ordering.

1. Standard Land Pattern Dimensions

Land Pattern + Solder Resist
 Land Pattern
 Solder Resist

(in mm)

BLE32
BLM03
BLM15
BLM18
BLM21
BLM31
BLM41

● Reflow and Flow BLM Series

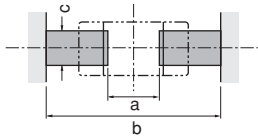

Type	Soldering	a	b	c
BLM03	Reflow	0.2-0.3	0.6-0.9	0.3
BLM15	Reflow	0.4	1.2-1.4	0.5
BLM18	Flow (except 18G)	0.7	2.2-2.6	0.7
	Reflow		1.8-2.0	
BLM21	Flow/ Reflow	1.2	3.0-4.0	1.0

- Except for BLM03PG·PX·EB/15AX·PD·PG·PX/18PG·KG·SG/21PG. And BLM03/15/18G is specially adapted for reflow soldering.
- BLM18A_WH series is designed for conductive glue mounting method, not for normal soldering method. Please contact us for applicable mounting method for BLM18A_WH series.

BLE32PN·BLM□□AX/P/K/S/E

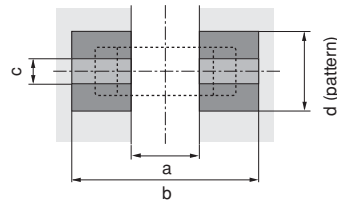

Type	Rated Current (A)	Soldering	a	b	c	Land Pad Thickness and Dimension d		
						18μm	35μm	70μm
BLE32PN	10	Flow/ Reflow	1.9	3.6	2.7	-	4.0 (Temperature 85°C or less)	-
						-	8.0 (Temperature 125°C or less)	-
BLM03AX	0.9max.	Reflow	0.2-0.3	0.6-0.9	0.3	0.3	0.3	0.3
BLM03P□	1.8max.					1.2	0.7	0.3
BLM03EB	1.5max.	Reflow	0.4	1.2-1.4	0.5	0.5	0.5	0.5
BLM15AX	2.2max.					1.2	0.7	0.5
BLM15PD	3.0max.					2.4	1.2	0.5
BLM15PG						2.4	1.2	0.5
BLM15PX								
BLM18PG	0.5-1.5	Flow/ Reflow	0.7	Flow 2.2-2.6 Reflow 1.8-2.0	0.7	0.7	0.7	0.7
	1.7-2.5					1.2	0.7	0.7
	3-4					2.4	1.2	0.7
	5-6					6.4	3.3	1.65
BLM21PG	1.5	Flow/ Reflow	1.2	3.0-4.0	1.0	1.0	1.0	1.0
	2					1.2	1.0	1.0
	3-4					2.4	1.2	1.0
	6					6.4	3.3	1.65
BLM31PG	1.5-2	Flow/ Reflow	2.0	4.2-5.2	1.2	1.2	1.2	1.2
	3.5					2.4	1.2	1.2
	6					6.4	3.3	1.65
BLM41PG	1.5-2	Flow/ Reflow	3.0	5.5-6.5	1.2	1.2	1.2	1.2
	3.5					2.4	1.2	1.2
	6					6.4	3.3	1.65

- About land pad thickness of BLE32PN, please note the upper limit of the temperature.
- Do not apply narrower pattern than listed above to BLM□□AX/P/K/S. Narrow pattern can cause excessive heat or open circuit.

● PCB Warping

PCB should be designed so that products are not subjected to the mechanical stress caused by warping the board.

Products should be located in the sideways direction (Length: a<b) to the mechanical stress.

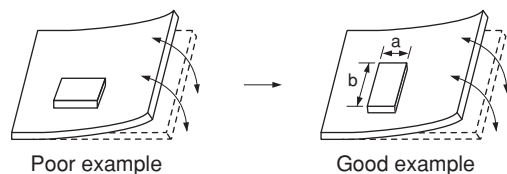

[△]Note • Please read rating and [△]CAUTION (for storage, operating, rating, soldering, mounting and handling) in this catalog to prevent smoking and/or burning, etc.
 • This catalog has only typical specifications. Therefore, please approve our product specifications or transact the approval sheet for product specifications before ordering.

2. Solder Paste Printing and Adhesive Application

When reflow soldering the chip ferrite beads and bead inductor the printing must be conducted in accordance with the following cream solder printing conditions.

If too much solder is applied, the chip will be prone to damage by mechanical and thermal stress from the PCB and may crack.

Standard land dimensions should be used for resist and copper foil patterns.

When flow soldering the chip ferrite beads and bead inductor apply the adhesive in accordance with the following conditions.

If too much adhesive is applied, then it may overflow into the land or termination areas and yield poor solderability. In contrast, if insufficient adhesive is applied, or if the adhesive is not sufficiently hardened, then the chip may become detached during flow soldering process.

(in mm)

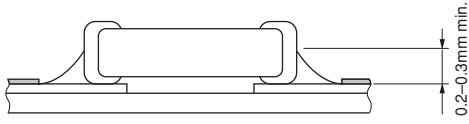
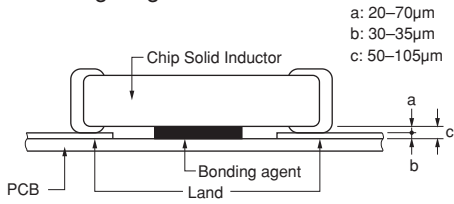
Series	Solder Paste Printing	Adhesive Application
BLM BLE	<ul style="list-style-type: none"> ● Ensure that solder is applied smoothly to a minimum height of 0.2mm to 0.3mm at the end surface of the part. ● Guideline of solder paste thickness: 100-150µm: BLM03 100-200µm: BLM15/18/21/31/41/BLE32 	<ul style="list-style-type: none"> ■ BLM18/21/31/41 Series (Except for BLM18G Series) Coating amount is illustrated in the following diagram.  <p>a: 20-70µm b: 30-35µm c: 50-105µm</p>

3. Standard Soldering Conditions

(1) Soldering Methods

Use flow and reflow soldering methods only.

Use standard soldering conditions when soldering chip ferrite beads and bead inductor.

In cases where several different parts are soldered, each having different soldering conditions, use those conditions requiring the least heat and minimum time.

Solder: Use Sn-3.0Ag-0.5Cu solder. Use of Sn-Zn based solder will deteriorate performance of products. If using BLA series with Sn-Zn based solder, please contact Murata in advance.

Flux:

- Use Rosin-based flux.
In case of using RA type solder, products should be cleaned completely with no residual flux.
- Do not use strong acidic flux (with chlorine content exceeding 0.20wt%)
- Do not use water-soluble flux.

For additional mounting methods, please contact Murata.

△Note • Please read rating and △CAUTION (for storage, operating, rating, soldering, mounting and handling) in this catalog to prevent smoking and/or burning, etc.
• This catalog has only typical specifications. Therefore, please approve our product specifications or transact the approval sheet for product specifications before ordering.

Soldering and Mounting Chip Ferrite Bead
 Chip EMIFIL® SMD Type
 Chip Common Mode Choke Coil SMD Type
 Block Type EMIFIL® SMD Type
 EMI Suppression Filters Lead Type
 Microchip Transformer (Balun) SMD Type

(2) Soldering Profile

● Flow Soldering Profile
(Sn-3.0Ag-0.5Cu Solder)

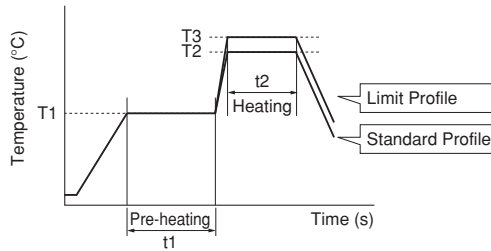

Series	Pre-heating		Standard Profile			Limit Profile		
	Temp. (T1)	Time. (t1)	Heating		Cycle of Flow	Heating		Cycle of Flow
			Temp. (T2)	Time. (t2)		Temp. (T3)	Time. (t2)	
BLM (Except for BLM03/15/18G/18AG_W) BLE	150°C	60s min.	250°C	4 to 6s	2 times max.	265±3°C	5s max.	2 times max.

● Reflow Soldering Profile
(Sn-3.0Ag-0.5Cu Solder)

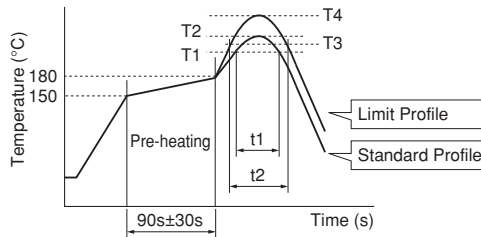

Series	Standard Profile				Limit Profile			
	Heating		Peak Temperature (T2)	Cycle of Reflow	Heating		Peak Temperature (T4)	Cycle of Reflow
	Temp. (T1)	Time. (t1)			Temp. (T3)	Time. (t2)		
BLM (Except for BLM18AG_W) BLE	220°C min.	30 to 60s	245±3°C	2 times max.	230°C min.	60s max.	260°C/10s	2 times max.

(3) Reworking with Solder Iron

The following conditions must be strictly followed when using a soldering iron.

Pre-heating: 150°C 60s min.

Soldering iron power output / Tip diameter:

80W max. / ø3mm max.

Temperature of soldering iron tip / Soldering time / Times:
350°C max. / 3-4s / 2 times

Do not allow the tip of the soldering iron to directly contact the chip.

For additional methods of reworking with a soldering iron, please contact Murata engineering.

⚠Note • Please read rating and ⚠CAUTION (for storage, operating, rating, soldering, mounting and handling) in this catalog to prevent smoking and/or burning, etc.
• This catalog has only typical specifications. Therefore, please approve our product specifications or transact the approval sheet for product specifications before ordering.

4. Mounting on-board with Conductive Glue of BLM18AG_WH1

Please adhere rigidly to the condition below which shows the method of mounting with conductive glue.
 Please coat print pads with conductive glue using metal mask and metal squeegee, and then mount our products on the substrates with a mount machine or human hand.
 Please put the substrates into an oven (140 to 150°C) for 30 minutes in order to cure the adhesive.
 Please check whether the chips and the substrates are connected with the conductive glue or not and there is no electrical short of the conductive glue.

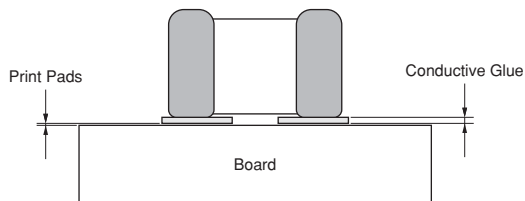

1. Board	Ceramic Board or Alumina Board
2. Thickness of Glue	30 to 50µm
3. Recommended Conductive Glue	PC3000 (Manufactured by Heraeus)

5. Cleaning

Following conditions should be observed when cleaning chip ferrite beads.

- (1) Cleaning Temperature: 60°C max. (40°C max. for alcohol type cleaner)
- (2) Ultrasonic
 - Output: 20W/liter max.
 - Duration: 5 minutes max.
 - Frequency: 28 to 40kHz
- (3) Cleaning Agent

The following list of cleaning agents have been tested on the individual components. Evaluation of final assembly should be completed prior to production.
 Do not clean BLM18AG□□□WH1 series. Before cleaning, please contact Murata engineering.

 - (a) Alcohol cleaning agent
 - Isopropyl alcohol (IPA)
 - (b) Aqueous cleaning agent
 - Pine Alpha ST-100S

- (4) Ensure that flux residue is completely removed. Component should be thoroughly dried after aqueous agent has been removed with deionized water.
- (5) BLM_G type is processed with resin. On rinsing the product, using water for ultrasonic cleaning may affect the resin quality used for the product by water element. In case of set cleaning conditions, please make sure the reliability according to the cleaning conditions.

For additional cleaning methods, please contact Murata engineering.

△Note • Please read rating and △CAUTION (for storage, operating, rating, soldering, mounting and handling) in this catalog to prevent smoking and/or burning, etc.
 • This catalog has only typical specifications. Therefore, please approve our product specifications or transact the approval sheet for product specifications before ordering.

■ Minimum Quantity and Dimensions of 8mm Width Paper / Embossed Tape

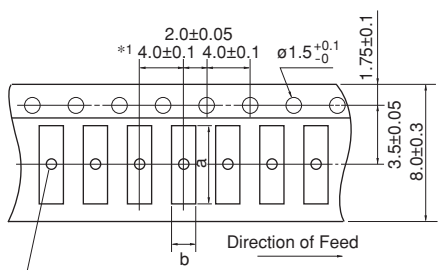

There are holes in the cavities of the BLM21BD222S□1/BD272S□1 and BLM31 only. $\phi 1.0 +0.3 -0$. BLE32 only. $\phi 1.0 +0.2 -0$.

*1 BLM03/15: 2.0 ± 0.05
BLM18S/18T/BLA2A: 2.0 ± 0.1

Dimension of the cavity of embossed tape is measured at the bottom side.

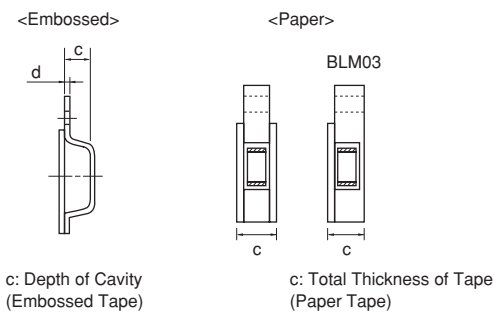

Part Number	Dimensions				Minimum Qty. (pcs.)				Bulk
					ø180mm Reel		ø330mm Reel		
	a	b	c	d	Paper Tape	Embossed Tape	Paper Tape	Embossed Tape	
BLM03	0.70	0.40	0.55 max.	-	15000	-	50000	-	1000
BLM15	1.15	0.65	0.8 max.	-	10000	-	50000	-	1000
BLM18A/B/P/H/G	1.85	1.05	1.1 max.	-	4000	-	10000	-	1000
BLM18EG/KG_T□	1.85	1.05	0.85 max.	-	4000	-	10000	-	1000
BLM18EG/KG_S□			1.1 max.						
BLM18S	1.85	1.05	0.90 max.	-	10000	-	30000	-	1000
BLM21	2.25	1.45	1.1 max.	-	4000	-	10000	-	1000
BLM31	3.5	1.9	1.3	0.2	-	3000	-	10000	1000
BLM21BD222S□1/272S□1	2.25	1.45	1.3	0.2	-	3000	-	10000	1000
BLE32	3.2	2.8	2.3	0.25	-	1500	-	7000	1000

(in mm)

■ Minimum Quantity and Dimensions of 12mm Width Embossed Tape

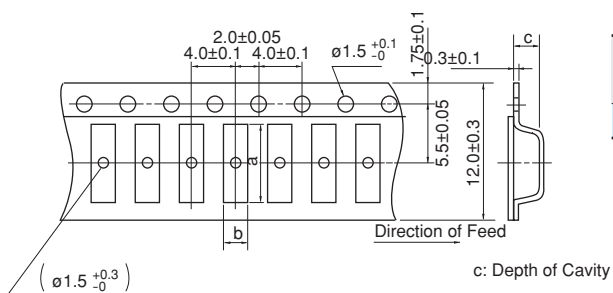

Dimension of the cavity is measured at the bottom side.

Part Number	Dimensions			Minimum Qty. (pcs.)		
	a	b	c	ø180mm Reel	ø330mm Reel	Bulk
BLM41	4.8	1.9	1.75	2500	8000	1000

(in mm)

"Minimum Quantity" means the number of units of each delivery or order. The quantity should be an integral multiple of the "Minimum Quantity."

△Note • Please read rating and △CAUTION (for storage, operating, rating, soldering, mounting and handling) in this catalog to prevent smoking and/or burning, etc.
• This catalog has only typical specifications. Therefore, please approve our product specifications or transact the approval sheet for product specifications before ordering.

Chip Ferrite Bead Packaging
 SMD Type Chip EMIFIL®
 SMD Type Chip Common Mode Choke Coil
 SMD Type Block Type EMIFIL®
 Lead Type EMI Suppression Filters
 SMD Type Microchip Transformer (Balun)



Capacitor

(Part Number)

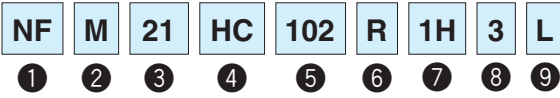

① Product ID

Product ID	
NF	Chip EMIFIL [®]

② Structure

Code	Structure
M	Capacitor Type

③ Dimensions (L×W)

Code	Dimensions (L×W)	EIA
21	2.0×1.25mm	0805
31	3.2×1.6mm	1206

④ Features

Code	Features	
HC	For Automotive	Powertrain, Safety
HK		

⑤ Capacitance

Expressed by three figures. The unit is in pico-farad (pF). The first and second figures are significant digits, and the third figure expresses the number of zeros that follow the two figures.

⑨ Packaging

Code	Packaging	Series
L	Embossed Taping (ø180mm Reel)	NFM31
B	Bulk	All series
D	Paper Taping (ø180mm Reel)	NFM21

⑥ Characteristics

Code	Capacitance Temperature Characteristics
R	±15%, +15/-18%
U	-750 ±120ppm/°C

⑦ Rated Voltage

Code	Rated Voltage
1A	10V
1C	16V
1H	50V
2A	100V

⑧ Electrode/Others

Code	Electrode	Series
3	Sn Plating	NFM

△Note • Please read rating and △CAUTION (for storage, operating, rating, soldering, mounting and handling) in this catalog to prevent smoking and/or burning, etc.
• This catalog has only typical specifications. Therefore, please approve our product specifications or transact the approval sheet for product specifications before ordering.

Chip Ferrite Bead SMD Type
Chip EMIFIL[®] SMD Type
Chip Common Mode Choke Coil SMD Type
Block Type EMIFIL[®] SMD Type
EMI Suppression Filters Lead Type
Microchip Transformer (Balun) SMD Type

LC Combined

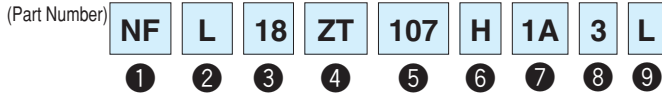

① Product ID

Product ID	
NF	Chip EMIFIL®

② Structure

Code	Structure
L	Multilayer, LC Combined Type
E	Block, LC Combined Type

③ Dimensions (L×W)

Code	Dimensions (L×W)	EIA
18	1.6×0.8mm	0603
31	3.2×1.6mm	1206
61	6.8×1.6mm	2706

④ Features

Code		Features
HT	For Automotive	Powertrain, Safety, T Circuit
ZT		Infotainment, T Circuit

⑤ Cut-off Frequency (NFL Series)

Expressed by three figures. The unit is in hertz (Hz). The first and second figures are significant digits, and the third figure expresses the number of zeros that follow the two figures.

⑤ Capacitance (NFE Series)

Expressed by three figures. The unit is in pico-farad (pF). The first and second figures are significant digits, and the third figure expresses the number of zeros that follow the two figures.

⑨ Packaging

Code	Packaging	Series
K	Embossed Taping (ø330mm Reel)	NFE
L	Embossed Taping (ø180mm Reel)	NFE
B	Bulk	NFL18/NFE
D	Paper Taping (ø180mm Reel)	NFL18

⑥ Characteristics (NFL Series)

Code	Characteristics
H	Cut-off Frequency

⑥ Characteristics (NFE Series)

Code	Capacitance Temperature Characteristics
C	±20%, ±22%
D	+20/-30%, +22/-33%
F	+30/-80%, +22/-82%
R	±15%
U	-750 ±120ppm/ °C
Z	Other

⑦ Rated Voltage

Code	Rated Voltage
1A	10V
1E	25V
2A	100V

⑧ Electrode

Code	Electrode	Series
3	Sn Plating	NFL
9	Others	NFE

⚠Note • Please read rating and ⚠CAUTION (for storage, operating, rating, soldering, mounting and handling) in this catalog to prevent smoking and/or burning, etc.
 • This catalog has only typical specifications. Therefore, please approve our product specifications or transact the approval sheet for product specifications before ordering.

Inductor Type



① Product ID

Product ID	
NF	Chip EMIFIL®

② Structure

Code	Structure
Z	Inductor Type

③ Dimensions (L×W)

Code	Dimensions (L×W)	EIA
32	3.2×2.5mm	1210

④ Features

Code	Features
BW	Special Feature Classification

⑤ Impedance

Expressed by three figures. The unit is in ohm (Ω). The first and second figures are significant digits, and the third figure expresses the number of zeros that follow the two figures.

⑥ Inductance Tolerance

Code	Features
H	For General Use (LF Solder)

⑦ Category

Code	Category	
Z	For Automotive	Infotainment

⑧ Number of Circuits

Code	Number of Circuits
1	1 Circuit

⑨ Specification

Code	Specification
0	Standard Type
1	Low Rdc Type

⑩ Packaging

Code	Packaging
K	Embossed Taping (ϕ 330mm Reel)
L	Embossed Taping (ϕ 180mm Reel)
B	Bulk

△Note • Please read rating and △CAUTION (for storage, operating, rating, soldering, mounting and handling) in this catalog to prevent smoking and/or burning, etc.
 • This catalog has only typical specifications. Therefore, please approve our product specifications or transact the approval sheet for product specifications before ordering.

NFE31ZT Series 1206/3216 (inch/mm)

Meets 6A, T-type filter with built-in ferrite bead.

Appearance/Dimensions

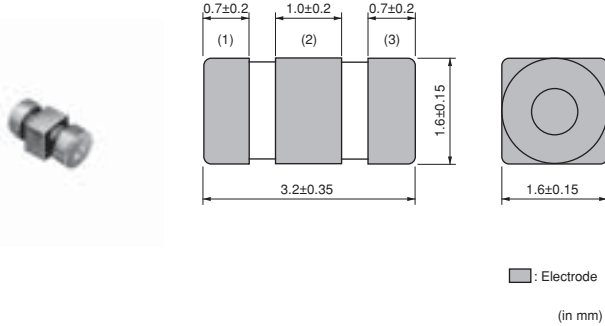

Packaging

Code	Packaging	Minimum Quantity
L	ø180mm Embossed Taping	2000
K	ø330mm Embossed Taping	8000
B	Packing in Bulk	500



Equivalent Circuit

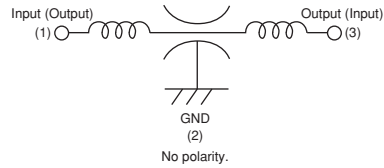

Refer to pages from p.96 to p.100 for mounting information.

Rated Value (□: packaging code)

Part Number		Capacitance	Rated Current	Rated Voltage	Insulation Resistance (min.)	Operating Temperature Range
For Infotainment	For Powertrain/Safety					
NFE31ZT220R1E9□	—	22pF ±30%	6A	25Vdc	1000MΩ	-40°C~+85°C
NFE31ZT470C1E9□	—	47pF 50/-20%	6A	25Vdc	1000MΩ	-40°C~+85°C
NFE31ZT101C1E9□	—	100pF 80/-20%	6A	25Vdc	1000MΩ	-40°C~+85°C
NFE31ZT221D1E9□	—	220pF 50/-20%	6A	25Vdc	1000MΩ	-40°C~+85°C
NFE31ZT471F1E9□	—	470pF 50/-20%	6A	25Vdc	1000MΩ	-40°C~+85°C
NFE31ZT222Z1E9□	—	2200pF ±50%	6A	25Vdc	1000MΩ	-40°C~+85°C

Number of Circuit: 1

Insertion Loss Characteristics (Main Items)

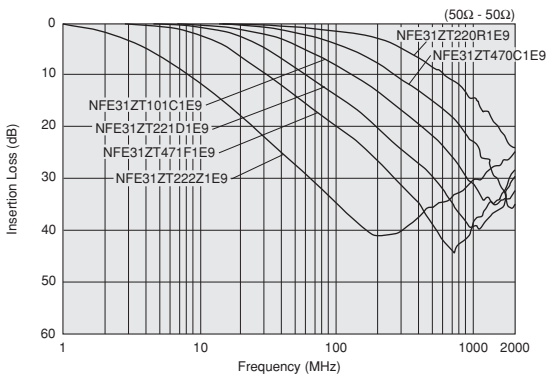

Note • Please read rating and CAUTION (for storage, operating, rating, soldering, mounting and handling) in this catalog to prevent smoking and/or burning, etc.
 • This catalog has only typical specifications. Therefore, please approve our product specifications or transact the approval sheet for product specifications before ordering.

SMD Type
Chip Ferrite Bead
SMD Type
Chip EMIFIL®
SMD Type
Chip Common Mode Choke Coil
SMD Type
Block Type EMIFIL®
Lead Type
EMI Suppression Filters
SMD Type
Microchip Transformer (Balun)

NFE61HT Series 2706/6816 (inch/mm)

T-type filter with built-in ferrite bead.

■ Appearance/Dimensions

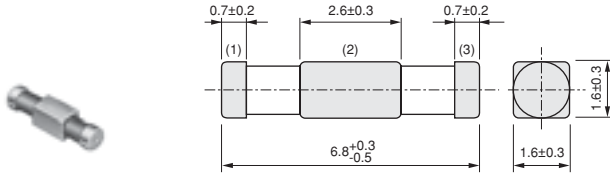

(in mm)

■ Packaging

Code	Packaging	Minimum Quantity
L	ø180mm Embossed Taping	2500
K	ø330mm Embossed Taping	8000
B	Packing in Bulk	500

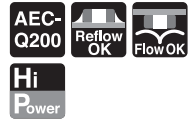

■ Equivalent Circuit

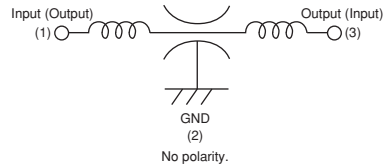

Refer to pages from p.96 to p.100 for mounting information.

■ Rated Value (□: packaging code)

Part Number		Capacitance	Rated Current	Rated Voltage	Insulation Resistance (min.)	Operating Temperature Range
For Infotainment	For Powertrain/Safety					
—	NFE61HT330U2A9□	33pF ±30%	2A	100Vdc	1000MΩ	-55°C~+125°C
—	NFE61HT680R2A9□	68pF ±30%	2A	100Vdc	1000MΩ	-55°C~+125°C
—	NFE61HT101Z2A9□	100pF ±30%	2A	100Vdc	1000MΩ	-55°C~+125°C
—	NFE61HT181C2A9□	180pF ±30%	2A	100Vdc	1000MΩ	-55°C~+125°C
—	NFE61HT361C2A9□	360pF ±20%	2A	100Vdc	1000MΩ	-55°C~+125°C
—	NFE61HT681D2A9□	680pF ±30%	2A	100Vdc	1000MΩ	-55°C~+125°C
—	NFE61HT102F2A9□	1000pF 80/-20%	2A	100Vdc	1000MΩ	-55°C~+125°C
—	NFE61HT332Z2A9□	3300pF 80/-20%	2A	100Vdc	1000MΩ	-55°C~+125°C

Number of Circuit: 1

■ Insertion Loss Characteristics (Main Items)

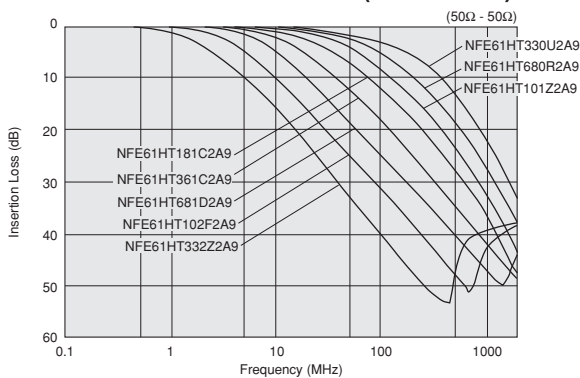

△Note • Please read rating and △CAUTION (for storage, operating, rating, soldering, mounting and handling) in this catalog to prevent smoking and/or burning, etc.
• This catalog has only typical specifications. Therefore, please approve our product specifications or transact the approval sheet for product specifications before ordering.

Chip Ferrite Bead
SMD Type

Chip EMIFIL®
SMD Type

Chip Common Mode Choke Coil
SMD Type

Block Type EMIFIL®
SMD Type

EMI Suppression Filters
Lead Type

Microchip Transformer (Balun)
SMD Type

NFM21HC Series 0805/2012 (inch/mm)

The 3-terminal capacitor has a good noise suppression effect at a high frequency range.

Appearance/Dimensions

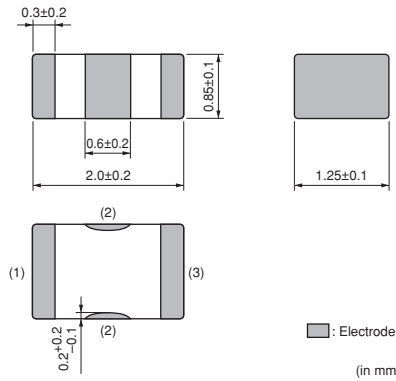

Packaging

Code	Packaging	Minimum Quantity
D	ø180mm Paper Taping	4000
B	Packing in Bulk	500



Equivalent Circuit

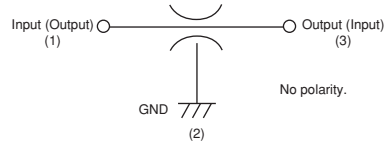

Refer to pages from p.96 to p.100 for mounting information.

Rated Value (□: packaging code)

Part Number		Capacitance	Rated Current	Rated Voltage	Insulation Resistance (min.)	Operating Temperature Range
For Infotainment	For Powertrain/Safety					
—	NFM21HC220U1H3□	22pF ±20%	700mA	50Vdc	1000MΩ	-55°C~+125°C
—	NFM21HC470U1H3□	47pF ±20%	700mA	50Vdc	1000MΩ	-55°C~+125°C
—	NFM21HC101U1H3□	100pF ±20%	700mA	50Vdc	1000MΩ	-55°C~+125°C
—	NFM21HC221R1H3□	220pF ±20%	700mA	50Vdc	1000MΩ	-55°C~+125°C
—	NFM21HC471R1H3□	470pF ±20%	1000mA	50Vdc	1000MΩ	-55°C~+125°C
—	NFM21HC102R1H3□	1000pF ±20%	1000mA	50Vdc	1000MΩ	-55°C~+125°C
—	NFM21HC222R1H3□	2200pF ±20%	1000mA	50Vdc	1000MΩ	-55°C~+125°C
—	NFM21HC223R1H3□	22000pF ±20%	2000mA	50Vdc	1000MΩ	-55°C~+125°C
—	NFM21HC104R1A3□	100000pF ±20%	2000mA	10Vdc	1000MΩ	-55°C~+125°C
—	NFM21HC224R1A3□	220000pF ±20%	2000mA	10Vdc	1000MΩ	-55°C~+125°C
—	NFM21HC105R1C3□	1000000pF ±20%	4000mA	16Vdc	500MΩ	-55°C~+125°C

Number of Circuit: 1

Insertion Loss Characteristics (Main Items)

NFM21HC_1H3 Series

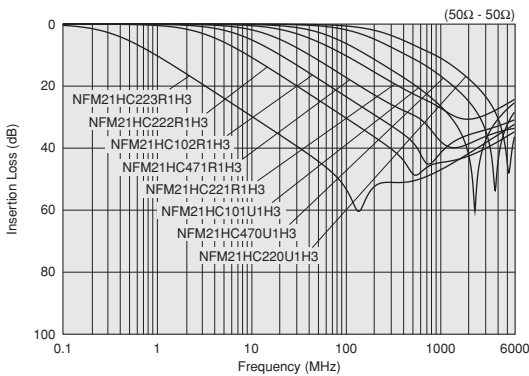

NFM21HC_1A3/1C3 Series

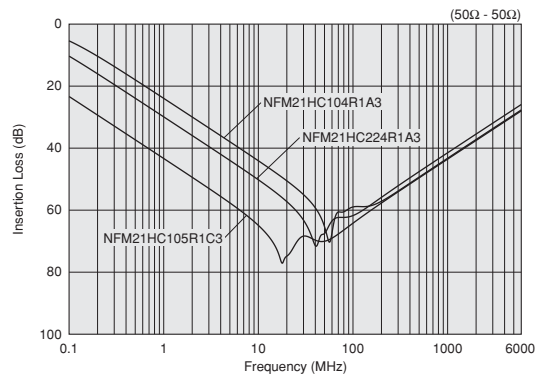

Note • Please read rating and CAUTION (for storage, operating, rating, soldering, mounting and handling) in this catalog to prevent smoking and/or burning, etc.
 • This catalog has only typical specifications. Therefore, please approve our product specifications or transact the approval sheet for product specifications before ordering.

NFM31HK Series 1206/3216 (inch/mm)

The 3-terminal capacitor has a good noise suppression effect at a high frequency range, meets 10A.

Appearance/Dimensions

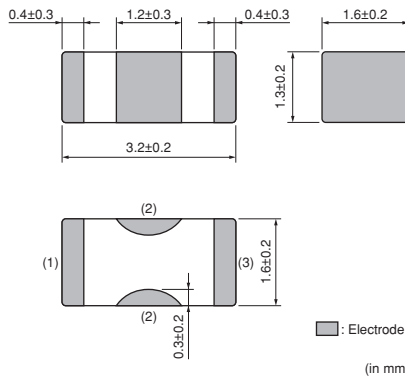

Packaging

Code	Packaging	Minimum Quantity
L	ø180mm Embossed Taping	3000
B	Packing in Bulk	500

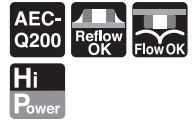

Equivalent Circuit

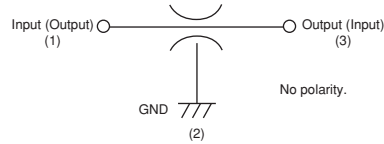

Refer to pages from p.96 to p.100 for mounting information.

Rated Value (□: packaging code)

Part Number		Capacitance	Rated Current	Rated Voltage	Insulation Resistance (min.)	Operating Temperature Range
For Infotainment	For Powertrain/Safety					
—	NFM31HK103R1H3□	10000pF ±20%	10A	50Vdc	1000MΩ	-55°C~+125°C
—	NFM31HK103R2A3□	10000pF ±20%	10A	100Vdc	1000MΩ	-55°C~+125°C
—	NFM31HK153R1H3□	15000pF ±20%	10A	50Vdc	1000MΩ	-55°C~+125°C
—	NFM31HK223R1H3□	22000pF ±20%	10A	50Vdc	1000MΩ	-55°C~+125°C
—	NFM31HK104R1H3□	100000pF ±20%	6A	50Vdc	1000MΩ	-55°C~+125°C

Number of Circuit: 1

Insertion Loss Characteristics (Main Items)

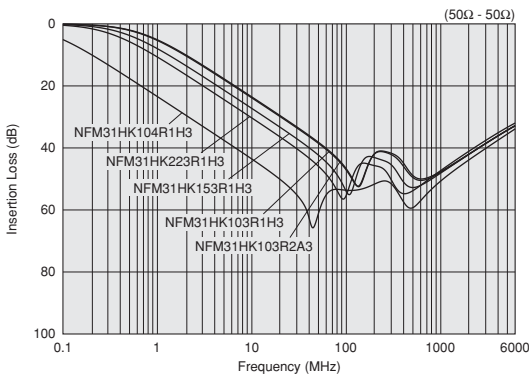

Derating of Rated Current

When NFM31HK series is used in operating temperatures exceeding +105°C, derating of current is necessary. Please apply the derating curve shown in chart according to the operating temperature.

Derating of Rated Current

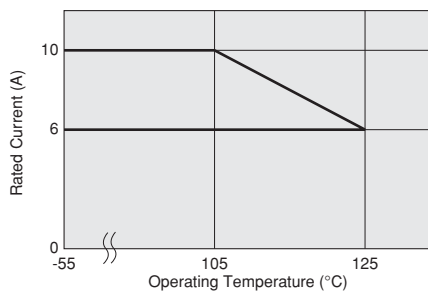

△Note • Please read rating and △CAUTION (for storage, operating, rating, soldering, mounting and handling) in this catalog to prevent smoking and/or burning, etc.
• This catalog has only typical specifications. Therefore, please approve our product specifications or transact the approval sheet for product specifications before ordering.

NFL18ZT Series 0603/1608 (inch/mm)

T-type LC filter. Reduces waveform distortion of high speed signal.

Appearance/Dimensions

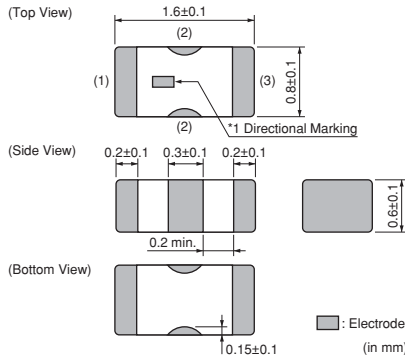

*1 There are no electrical polarity. But there is a directional marking on the top of product to identify inner physical direction.

Packaging

Code	Packaging	Minimum Quantity
D	ø180mm Paper Taping	4000
B	Packing in Bulk	1000



Equivalent Circuit

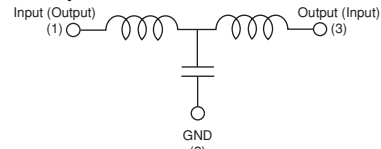

Refer to pages from p.96 to p.100 for mounting information.

Rated Value (□: packaging code)

Part Number		Nominal Cut-off Frequency	Capacitance	Inductance	Rated Current	Rated Voltage	Insulation Resistance (min.)	Withstand Voltage
For Infotainment	For Powertrain/Safety							
NFL18ZT506H1A3□	—	50MHz	110pF (Typ.)	350nH (Typ.)	75mA	10Vdc	1000MΩ	30Vdc
NFL18ZT706H1A3□	—	70MHz	70pF (Typ.)	230nH (Typ.)	75mA	10Vdc	1000MΩ	30Vdc
NFL18ZT107H1A3□	—	100MHz	50pF (Typ.)	150nH (Typ.)	75mA	10Vdc	1000MΩ	30Vdc
NFL18ZT207H1A3□	—	200MHz	22pF (Typ.)	110nH (Typ.)	100mA	10Vdc	1000MΩ	30Vdc
NFL18ZT307H1A3□	—	300MHz	16pF (Typ.)	74nH (Typ.)	100mA	10Vdc	1000MΩ	30Vdc
NFL18ZT507H1A3□	—	500MHz	10pF (Typ.)	42nH (Typ.)	100mA	10Vdc	1000MΩ	30Vdc

Operating Temperature Range: -55°C~+125°C Number of Circuits: 1

Insertion Loss Characteristics (Main Items)

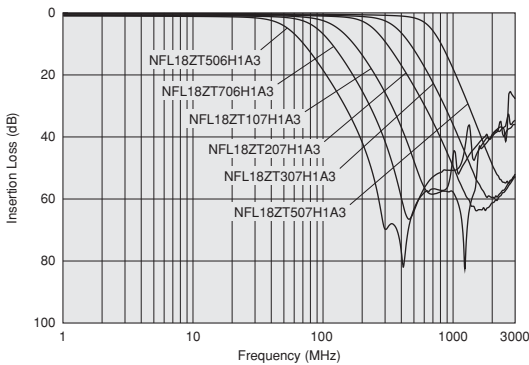

△Note • Please read rating and △CAUTION (for storage, operating, rating, soldering, mounting and handling) in this catalog to prevent smoking and/or burning, etc.
• This catalog has only typical specifications. Therefore, please approve our product specifications or transact the approval sheet for product specifications before ordering.

NFZ32BW_10 Series 1210/3225 (inch/mm)

For power lines · signal lines universal type, 1210 size, noise suppression filters.

Appearance/Dimensions

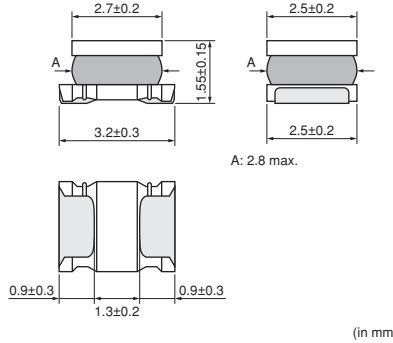

Packaging

Code	Packaging	Minimum Quantity
L	ø180mm Embossed Taping	2000
K	ø330mm Embossed Taping	7500

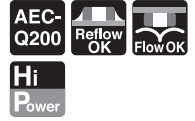

Equivalent Circuit

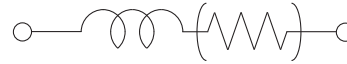

(Resistance element becomes dominant at high frequencies.)

Refer to pages from p.96 to p.100 for mounting information.

Rated Value (□: packaging code)

Part Number		Impedance (at 100MHz/20°C)	Impedance (at 1MHz/20°C)	Rated Current *	DC Resistance	Operating Temperature Range (Self-temperature rise is included)	Operating Temperature Range
For Infotainment	For Powertrain/Safety						
NFZ32BW3R6HZ10□	—	-	3.6Ω ±30%	2550mA	0.03Ω ±20%	-40°C~+125°C	-40°C~+105°C
NFZ32BW7R4HZ10□	—	-	7.4Ω ±30%	2050mA	0.045Ω ±20%	-40°C~+125°C	-40°C~+105°C
NFZ32BW9R0HZ10□	—	-	9.0Ω ±30%	1750mA	0.057Ω ±20%	-40°C~+125°C	-40°C~+105°C
NFZ32BW150HZ10□	—	-	15Ω ±30%	1600mA	0.076Ω ±20%	-40°C~+125°C	-40°C~+105°C
NFZ32BW210HZ10□	—	-	21Ω ±30%	1200mA	0.12Ω ±20%	-40°C~+125°C	-40°C~+105°C
NFZ32BW320HZ10□	—	-	32Ω ±30%	1000mA	0.18Ω ±20%	-40°C~+125°C	-40°C~+105°C
NFZ32BW420HZ10□	—	-	42Ω ±30%	850mA	0.24Ω ±20%	-40°C~+125°C	-40°C~+105°C
NFZ32BW700HZ10□	—	-	70Ω ±30%	700mA	0.38Ω ±20%	-40°C~+125°C	-40°C~+105°C
NFZ32BW111HZ10□	—	-	110Ω ±30%	520mA	0.57Ω ±20%	-40°C~+125°C	-40°C~+105°C
NFZ32BW151HZ10□	—	-	150Ω ±30%	450mA	0.81Ω ±20%	-40°C~+125°C	-40°C~+105°C
NFZ32BW221HZ10□	—	-	220Ω ±30%	390mA	1.15Ω ±20%	-40°C~+125°C	-40°C~+105°C
NFZ32BW291HZ10□	—	-	290Ω ±30%	310mA	1.78Ω ±20%	-40°C~+125°C	-40°C~+105°C
NFZ32BW451HZ10□	—	-	450Ω ±30%	275mA	2.28Ω ±20%	-40°C~+125°C	-40°C~+105°C
NFZ32BW621HZ10□	—	-	620Ω ±30%	250mA	2.7Ω ±20%	-40°C~+125°C	-40°C~+105°C
NFZ32BW881HZ10□	—	-	880Ω ±30%	200mA	4.38Ω ±20%	-40°C~+125°C	-40°C~+105°C

Number of Circuits: 1

* When Rated Current is applied to the Products, self-generation of heat will rise to 40°C or less.

Impedance-Frequency Characteristics (Main Items)

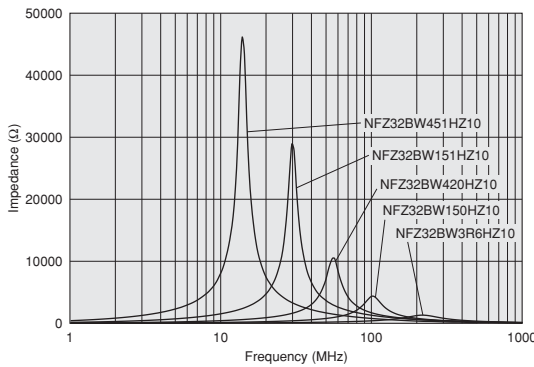

Derating of Rated Current

In operating temperature exceeding +85°C, derating of current is necessary for NFZ32BW_H□10 series.

Please apply the derating curve shown in chart according to the operating temperature.

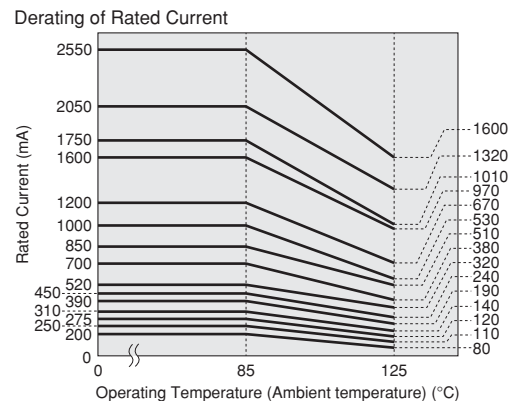

Continued on the following page.

⚠Note • Please read rating and ⚠CAUTION (for storage, operating, rating, soldering, mounting and handling) in this catalog to prevent smoking and/or burning, etc.
• This catalog has only typical specifications. Therefore, please approve our product specifications or transact the approval sheet for product specifications before ordering.

Impedance-Frequency Characteristics

NFZ32BW3R6HZ10

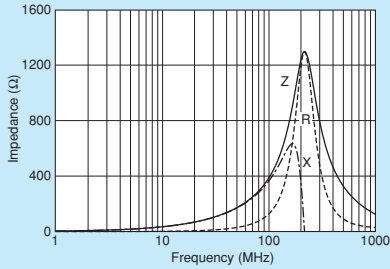

NFZ32BW7R4HZ10

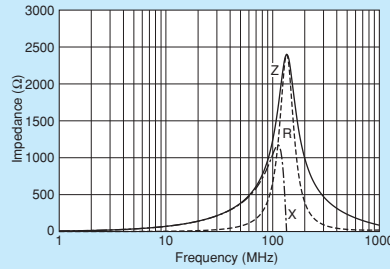

NFZ32BW9R0HZ10

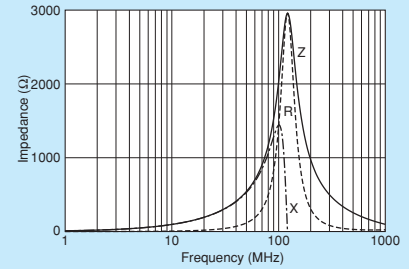

NFZ32BW150HZ10

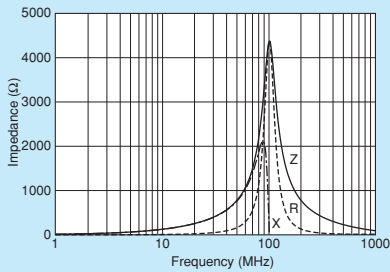

NFZ32BW210HZ10

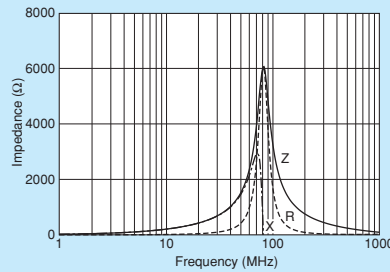

NFZ32BW320HZ10

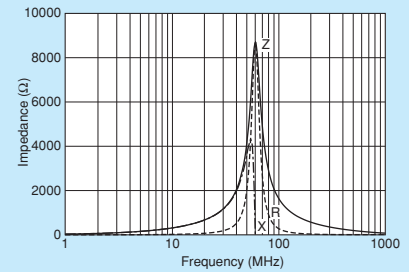

NFZ32BW420HZ10

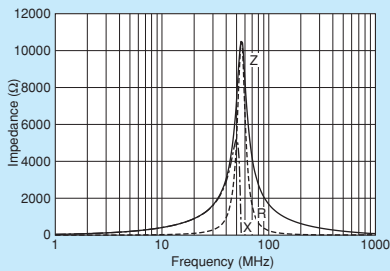

NFZ32BW700HZ10

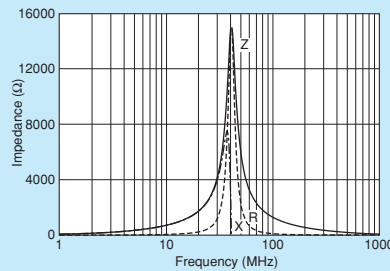

NFZ32BW111HZ10

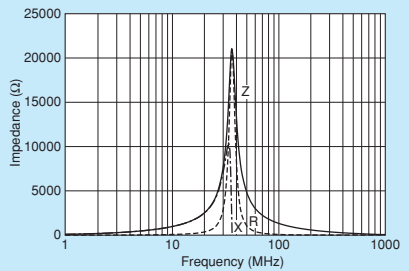

NFZ32BW151HZ10

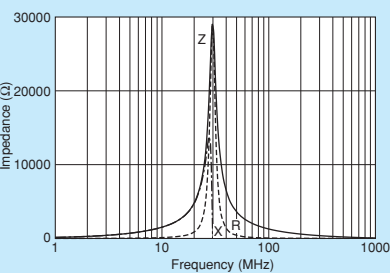

NFZ32BW221HZ10

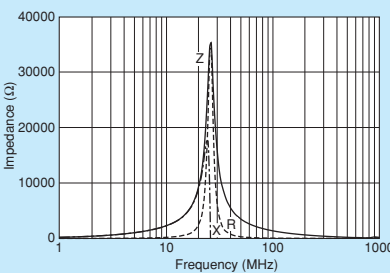

NFZ32BW291HZ10

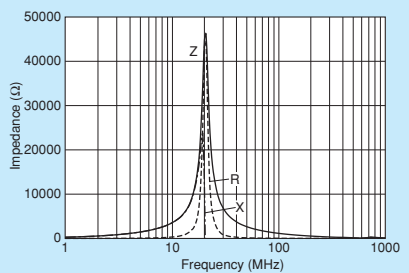

NFZ32BW451HZ10

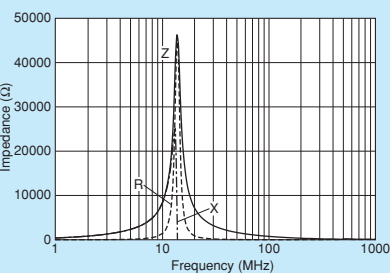

NFZ32BW621HZ10

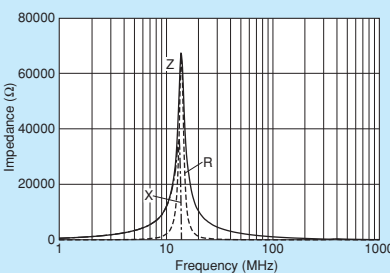

NFZ32BW881HZ10

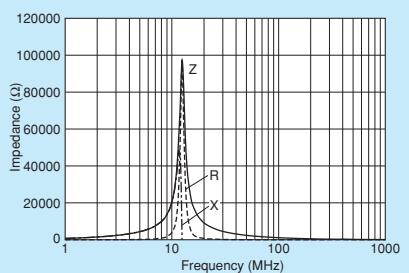

⚠Note • Please read rating and ⚠CAUTION (for storage, operating, rating, soldering, mounting and handling) in this catalog to prevent smoking and/or burning, etc.
• This catalog has only typical specifications. Therefore, please approve our product specifications or transact the approval sheet for product specifications before ordering.

NFZ32BW_11 Series 1210/3225 (inch/mm)

For power lines · signal lines universal type, 1210 size, noise suppression filters.

■ Appearance/Dimensions

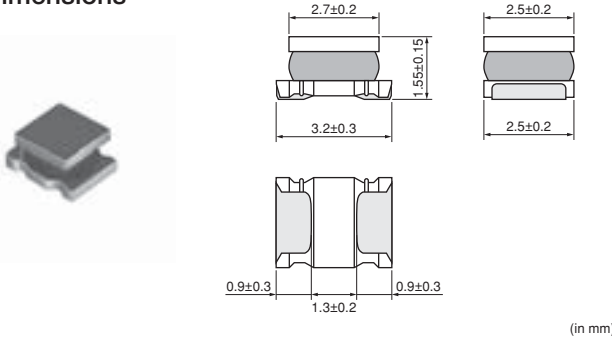

■ Packaging

Code	Packaging	Minimum Quantity
L	ø180mm Embossed Taping	2000
K	ø330mm Embossed Taping	7500

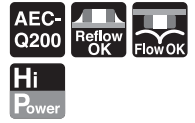

■ Equivalent Circuit

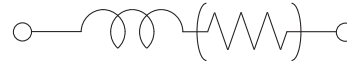

(Resistance element becomes dominant at high frequencies.)

Refer to pages from p.96 to p.100 for mounting information.

■ Rated Value (□: packaging code)

Part Number		Impedance (at 100MHz/20°C)	Impedance (at 1MHz/20°C)	Rated * Current	DC Resistance	Operating Temperature Range (Self-temperature rise is included)	Operating Temperature Range
For Infotainment	For Powertrain/Safety						
NFZ32BW3R3HZ11□	—	-	3.3Ω ±30%	2900mA	0.024Ω ±20%	-40°C~+125°C	-40°C~+105°C
NFZ32BW6R8HZ11□	—	-	6.8Ω ±30%	2500mA	0.036Ω ±20%	-40°C~+125°C	-40°C~+105°C
NFZ32BW8R4HZ11□	—	-	8.4Ω ±30%	2400mA	0.048Ω ±20%	-40°C~+125°C	-40°C~+105°C
NFZ32BW9R8HZ11□	—	-	9.8Ω ±30%	2100mA	0.053Ω ±20%	-40°C~+125°C	-40°C~+105°C
NFZ32BW120HZ11□	—	-	12Ω ±30%	1850mA	0.064Ω ±20%	-40°C~+125°C	-40°C~+105°C
NFZ32BW190HZ11□	—	-	19Ω ±30%	1800mA	0.089Ω ±20%	-40°C~+125°C	-40°C~+105°C
NFZ32BW210HZ11□	—	-	21Ω ±30%	1550mA	0.100Ω ±20%	-40°C~+125°C	-40°C~+105°C
NFZ32BW310HZ11□	—	-	31Ω ±30%	1200mA	0.155Ω ±20%	-40°C~+125°C	-40°C~+105°C
NFZ32BW520HZ11□	—	-	52Ω ±30%	1100mA	0.220Ω ±20%	-40°C~+125°C	-40°C~+105°C
NFZ32BW650HZ11□	—	-	65Ω ±30%	900mA	0.295Ω ±20%	-40°C~+125°C	-40°C~+105°C
NFZ32BW101HZ11□	—	-	100Ω ±30%	900mA	0.475Ω ±20%	-40°C~+125°C	-40°C~+105°C
NFZ32BW151HZ11□	—	-	150Ω ±30%	700mA	0.685Ω ±20%	-40°C~+125°C	-40°C~+105°C

Number of Circuits: 1

* When Rated Current is applied to the Products, self-generation of heat will rise to 40°C or less.

■ Impedance-Frequency Characteristics (Main Items)

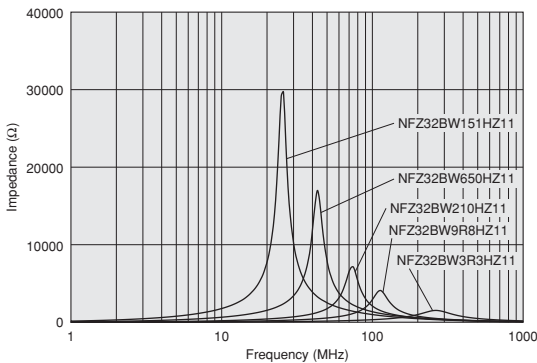

■ Derating of Rated Current

In operating temperature exceeding +85°C, derating of current is necessary for NFZ32BW_H□11 series.

Please apply the derating curve shown in chart according to the operating temperature.

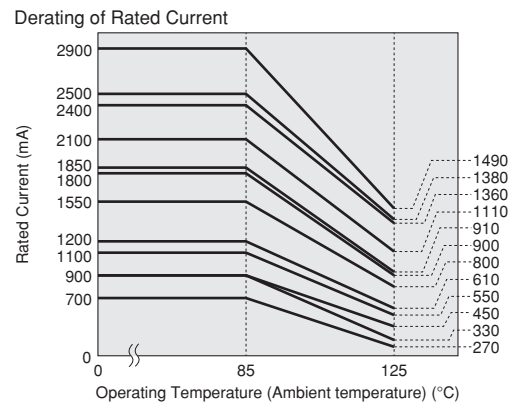

Continued on the following page. ↗

△Note • Please read rating and △CAUTION (for storage, operating, rating, soldering, mounting and handling) in this catalog to prevent smoking and/or burning, etc.
• This catalog has only typical specifications. Therefore, please approve our product specifications or transact the approval sheet for product specifications before ordering.

Chip Ferrite Bead SMD Type

Chip EMIFIL® SMD Type

Chip Common Mode Choke Coil SMD Type

Block Type EMIFIL® SMD Type

EMI Suppression Filters Lead Type

Microchip Transformer (Balun) SMD Type

Impedance-Frequency Characteristics

NFZ32BW3R3HZ11

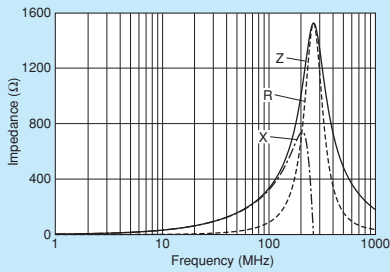

NFZ32BW6R8HZ11

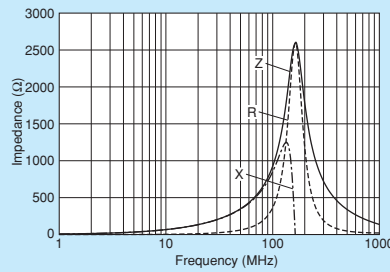

NFZ32BW8R4HZ11

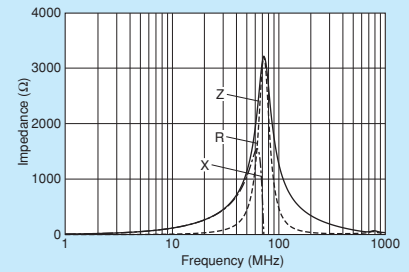

NFZ32BW9R8HZ11

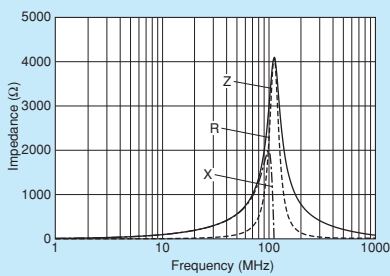

NFZ32BW120HZ11

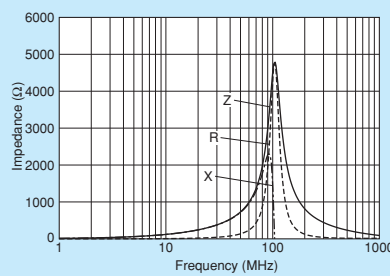

NFZ32BW190HZ11

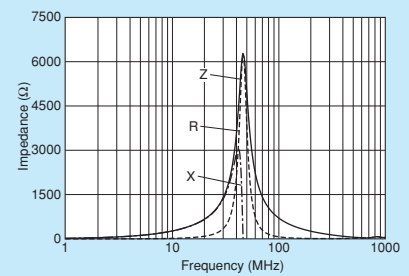

NFZ32BW210HZ11

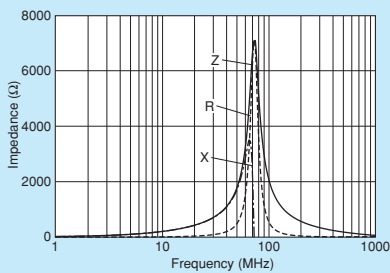

NFZ32BW310HZ11

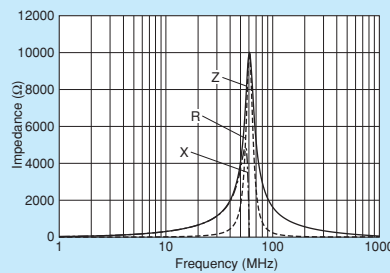

NFZ32BW520HZ11

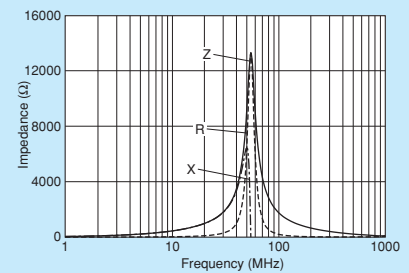

NFZ32BW650HZ11

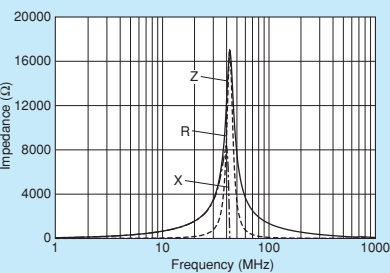

NFZ32BW101HZ11

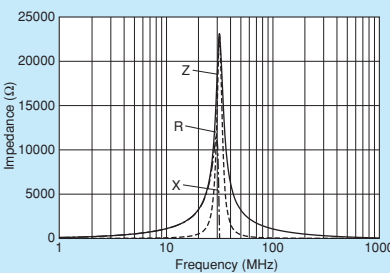

NFZ32BW151HZ11

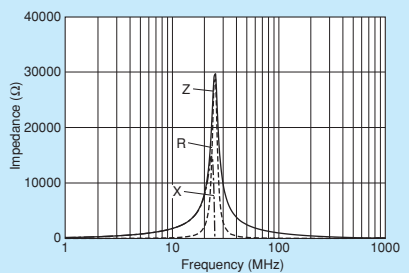

Note • Please read rating and **CAUTION** (for storage, operating, rating, soldering, mounting and handling) in this catalog to prevent smoking and/or burning, etc.
 • This catalog has only typical specifications. Therefore, please approve our product specifications or transact the approval sheet for product specifications before ordering.

⚠ Caution

● Rating

1. About the Rated Current
Do not use products beyond the rated current and rated voltage as this may create excessive heat and deteriorate the insulation resistance.
2. About the Excessive Surge Current (NFZ Series)
Excessive surge current (pulse current or rush current) than specified rated current applied to the product may cause a critical failure, such as an open circuit, burnout caused by excessive temperature rise. Please contact us in advance in case of applying the surge current.

● Soldering and Mounting

1. Self-heating
Please provide special attention when mounting chip EMIFIL® NFM□□H series in close proximity to other products that radiate heat.
The heat generated by other products may deteriorate the insulation resistance and cause excessive heat in this component.
Worst case, results to a short circuit which causes fuming or partial dispersion when the product is used.
2. Be sure to provide an appropriate fail-safe function on your product to prevent a second damage that may be caused by the abnormal function or the failure our product.

Notice

● Storage and Operating Conditions

<Operating Environment>

Do not use products in a chemical atmosphere such as chlorine gas, acid or sulfide gas.

Do not use products in the environment close to the organic solvent.

<Storage and Handling Requirements>

1. Storage Period
The NF series should be used within 12 months.
Products to be used after this period should be checked for solderability or bondability with glue.
2. Storage Conditions
 - (1) Storage temperature: -10 to +40°C
Relative humidity: 15 to 85%
Avoid sudden changes in temperature and humidity.
 - (2) Do not store products in a chemical atmosphere such as chlorine gas, acid or sulfide gas.

● Notice (Soldering and Mounting)

1. Cleaning
Failure and degradation of a product are caused by the cleaning method. When you clean in conditions that are not in mounting information, please contact Murata engineering.
2. Soldering
Reliability decreases with improper soldering methods. Please solder by the standard soldering conditions shown in mounting information.
3. Points of Attention about NFM Pattern Forms
The loaded stresses are different to a chip depend on PCB materials and structures.
When the chip will be mounted on the metal PCB contained alumina material, PCB heat expansion/contraction will be a cause of chip cracks because the coefficients of thermal expressions are different between metal PCB and the chip itself.
4. Other
Noise suppression levels resulting from Murata's EMI suppression filters EMIFIL® may vary, depending on the circuits and ICs used, type of noise, mounting pattern, mounting location, and other operating conditions. Be sure to check and confirm in advance the noise suppression effect of each filter, in actual circuits, etc. before applying the filter in a commercial-purpose equipment design.

Continued on the following page. ↗

⚠Note • Please read rating and ⚠CAUTION (for storage, operating, rating, soldering, mounting and handling) in this catalog to prevent smoking and/or burning, etc.
• This catalog has only typical specifications. Therefore, please approve our product specifications or transact the approval sheet for product specifications before ordering.

● Handling

1. Resin Coating (Except for NFZ Series)

Using resin for coating/molding products may affect the products performance.

So please pay careful attention in selecting resin.

Prior to use, please make the reliability evaluation with the product mounted in your application set.

Resin Coating (NFZ_W Series)

To prevent breaking the wire, avoid touching with sharp material, such as tweezers or other material such as bristles of cleaning brush, to the wire wound portion of this product. To prevent breaking the core, avoid applying excessive mechanical shock to products mounted on the board. An open circuit issue may occur by mechanical stress caused by the resin, amount/cured shape of resin, or operating condition etc. Some resins containing impurities or chloride may possibly.

2. Handling of a Substrate

After mounting products on a substrate, do not apply any stress to the product caused by bending or twisting to the substrate when cropping the substrate, inserting and removing a connector from the substrate or tightening screw to the substrate.

Excessive mechanical stress may cause cracking in the Product.

Bending

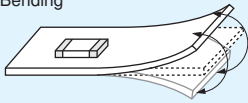

Twisting

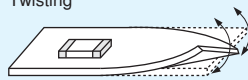

⚠ Note • Please read rating and ⚠ CAUTION (for storage, operating, rating, soldering, mounting and handling) in this catalog to prevent smoking and/or burning, etc.
• This catalog has only typical specifications. Therefore, please approve our product specifications or transact the approval sheet for product specifications before ordering.

1. Standard Land Pattern Dimensions

NF□ series suppress noise by conducting the high-frequency noise element to ground. Therefore, to obtain maximum performance from these filters, the ground pattern should be made as large as possible during the PCB design stage. As shown below, one side of the PCB is used for chip mounting, and the other is used for grounding.

Small diameter feedthrough holes are then used to connect the grounds on each side of the PCB. This reduces the high-frequency impedance of the grounding and maximizes the filter's performance.

 Land Pattern + Solder Resist
 Land Pattern
 Solder Resist (in mm)

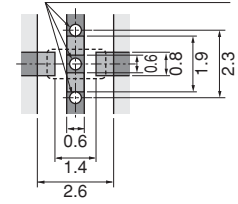
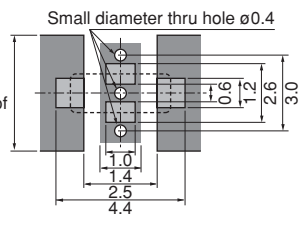
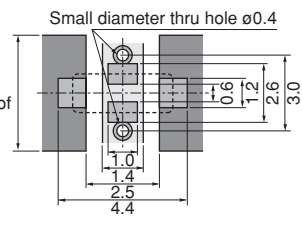
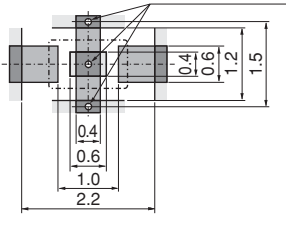
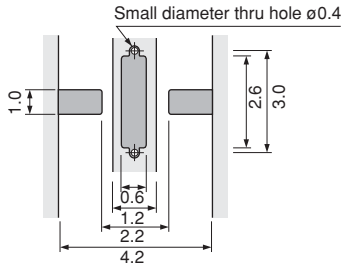
NFM21HC	<p>● Reflow Soldering</p> <p>NFM21HC</p> <p>Small diameter thru hole $\phi 0.4$</p>  <p>The chip EMI filter suppresses noise by conducting the high-frequency noise to ground. Therefore, to get enough noise reduction, feed through holes which are connected to ground-plane should be arranged according to the figure to reinforce the ground pattern. NFM21HC is specially adapted for reflow soldering.</p> <p>Please contact us if using thinner land pad than 18μm.</p>	
NFM31HK	<p>● Reflow Soldering Chip mounting side</p> <p>NFM31HK*1</p> <p>Small diameter thru hole $\phi 0.4$</p> <p>10mm or more (in case of 10A)</p>  <p>*1 For large current design, width of signal land pattern should be wider not less than 1mm per 1A (1mm/A). For example, in case of 10A, signal land pattern width should be 10mm or more. (1mm/A*10A=10mm)</p>	<p>● Flow Soldering Chip mounting side</p> <p>NFM31HK*1</p> <p>Small diameter thru hole $\phi 0.4$</p> <p>10mm or more (in case of 10A)</p>  <p>*1 For large current design, width of signal land pattern should be wider not less than 1mm per 1A (1mm/A). For example, in case of 10A, signal land pattern width should be 10mm or more. (1mm/A*10A=10mm)</p>
NFL18ZT	<p>● Reflow Soldering</p> <p>NFL18ZT</p> <p>Small diameter thru hole $\phi 0.2-\phi 0.3$</p>  <p>Please contact us if using thinner land pad than 18μm.</p>	
NFE31ZT	<p>● Reflow Soldering NFE31ZT</p> <p>Small diameter thru hole $\phi 0.4$</p> 	

Continued on the following page. 

△Note • Please read rating and △CAUTION (for storage, operating, rating, soldering, mounting and handling) in this catalog to prevent smoking and/or burning, etc.
 • This catalog has only typical specifications. Therefore, please approve our product specifications or transact the approval sheet for product specifications before ordering.

Chip Ferrite Bead SMD Type
 Soldering and Mounting Chip EMIFIL®
 Chip Common Mode Choke Coil SMD Type
 Block Type EMIFIL® SMD Type
 EMI Suppression Filters Lead Type
 Microchip Transformer (Balun) SMD Type

Land Pattern + Solder Resist
 Land Pattern
 Solder Resist (in mm)

<p>NFE61HT</p>	<p>● Reflow Soldering</p>	<p>● Flow Soldering (Except for NFE61HT332)</p>
<p>NFZ32BW</p>	<p>● Flow Soldering</p>	<p>● Reflow Soldering</p>

(1) PCB Warping

PCB should be designed so that products are not subjected to the mechanical stress caused by warping the board.

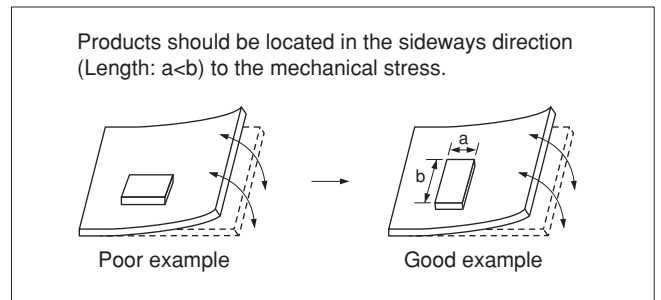

(2) Amount of Solder Paste

Excessive solder causes electrode corrosion, while insufficient solder causes low electrode bonding strength. Adjust the amount of solder paste as shown on the right so that solder is applied.

● Guideline of solder paste thickness

· NFZ32BW: 100 to 150µm

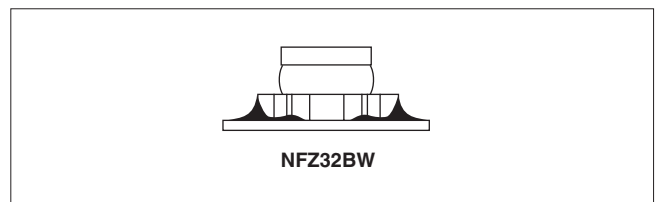

△Note • Please read rating and △CAUTION (for storage, operating, rating, soldering, mounting and handling) in this catalog to prevent smoking and/or burning, etc.
 • This catalog has only typical specifications. Therefore, please approve our product specifications or transact the approval sheet for product specifications before ordering.

SMD Type Chip Ferrite Bead
 Chip EMIFIL® Soldering and Mounting
 SMD Type Chip Common Mode Choke Coil
 SMD Type Block Type EMIFIL®
 Lead Type EMI Suppression Filters
 SMD Type Microchip Transformer (Balun)

2. Solder Paste Printing and Adhesive Application

When reflow soldering the chip EMI suppression filter, the printing must be conducted in accordance with the following cream solder printing conditions.

If too much solder is applied, the chip will be prone to damage by mechanical and thermal stress from the PCB and may crack.

Standard land dimensions should be used for resist and copper foil patterns.

When flow soldering the EMI suppression filter, apply the adhesive in accordance with the following conditions. If too much adhesive is applied, then it may overflow into the land or termination areas and yield poor solderability. In contrast, if insufficient adhesive is applied, or if the adhesive is not sufficiently hardened, then the chip may become detached during flow soldering process.

(in mm)

Series	Solder Paste Printing	Adhesive Application
NFM21HC NFM31HK	<p>●Guideline of solder paste thickness: 100-150µm: NFM21HC/31HK</p> <p>NFM21HC</p> <p>NFM31HK</p>	<p>■ NFM31HK Series</p> <p>Apply 0.06mg of bonding agent at each chip. Do not cover electrodes.</p>
NFL18ZT	<p>●Guideline of solder paste thickness: 100-150µm</p>	
NFE31ZT	<p>●Guideline of solder paste thickness: 150-200µm</p>	
NFE61HT	<p>●Guideline of solder paste thickness: 150-200µm</p>	

△Note • Please read rating and △CAUTION (for storage, operating, rating, soldering, mounting and handling) in this catalog to prevent smoking and/or burning, etc.
• This catalog has only typical specifications. Therefore, please approve our product specifications or transact the approval sheet for product specifications before ordering.

Chip Ferrite Bead SMD Type
 Soldering and Mounting Chip EMIFIL®
 Chip Common Mode Choke Coil SMD Type
 Block Type EMIFIL® SMD Type
 EMI Suppression Filters Lead Type
 Microchip Transformer (Balun) SMD Type

3. Standard Soldering Conditions

(1) Soldering Methods

Use flow and reflow soldering methods only.
 Use standard soldering conditions when soldering chip EMI suppression filters.
 In cases where several different parts are soldered, each having different soldering conditions, use those conditions requiring the least heat and minimum time.

Flux:

- Use Rosin-based flux.
 In case of using RA type solder, products should be cleaned completely with no residual flux.
- Do not use strong acidic flux (with chlorine content exceeding 0.20wt%)
- Do not use water-soluble flux.

Solder: Use Sn-3.0Ag-0.5Cu solder. Use of Sn-Zn based solder will deteriorate performance of products.
 If using NFM series with Sn-Zn based solder, please contact Murata in advance.

For additional mounting methods, please contact Murata.

(2) Soldering Profile

● Flow Soldering Profile (Sn-3.0Ag-0.5Cu Solder)

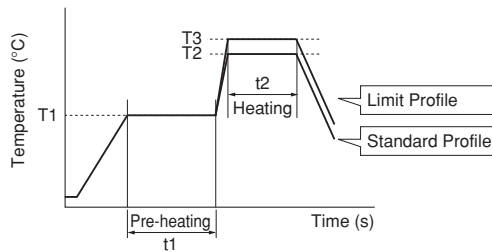

Series	Pre-heating		Standard Profile			Limit Profile		
	Temp. (T1)	Time. (t1)	Heating		Cycle of Flow	Heating		Cycle of Flow
			Temp. (T2)	Time. (t2)		Temp. (T3)	Time. (t2)	
NFM31HK	150°C	60s min.	250°C	4 to 6s	2 times max.	265±3°C	5s max.	2 times max.
NFE61HT (Except for NFE61HT332)	150°C	60s min.	250°C	4 to 6s	2 times max.	265±3°C	5s max.	2 times max.
NFZ32BW	150°C	60s min.	250°C	4 to 6s	2 times max.	265±3°C	5s max.	1 time

● Reflow Soldering Profile (Sn-3.0Ag-0.5Cu Solder)

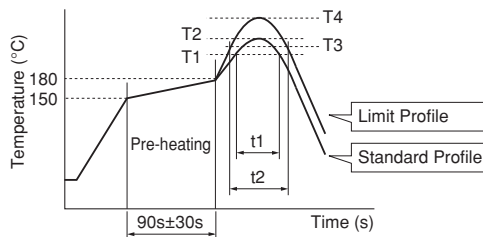

Series	Standard Profile				Limit Profile			
	Heating		Peak Temperature (T2)	Cycle of Reflow	Heating		Peak Temperature (T4)	Cycle of Reflow
	Temp. (T1)	Time. (t1)			Temp. (T3)	Time. (t2)		
NFM21HC NFM31HK	220°C min.	30 to 60s	245±3°C	2 times max.	230°C min.	60s max.	260°C/10s	2 times max.
NFE31ZT NFE61HT NFL18ZT	220°C min.	30 to 60s	245±3°C	2 times max.	230°C min.	60s max.	260°C/10s	2 times max.
NFZ32BW	220°C	30 to 60s	245±3°C	2 times max.	230°C	60s max.	260°C/10s	2 times max.

Continued on the following page.

△Note • Please read rating and △CAUTION (for storage, operating, rating, soldering, mounting and handling) in this catalog to prevent smoking and/or burning, etc.
 • This catalog has only typical specifications. Therefore, please approve our product specifications or transact the approval sheet for product specifications before ordering.

(3) Reworking with Solder Iron

The following conditions must be strictly followed when using a soldering iron.

Pre-heating: 150°C 60s min.

Soldering iron power output / Tip diameter:

30W max. / ø3mm max.*¹

*¹ NFZ32: 80W max. / ø3mm max.

Temperature of soldering iron tip / Soldering time / Times:

350°C max. / 3-4s / 2 times

Do not allow the tip of the soldering iron to directly contact the chip.

For additional methods of reworking with a soldering iron, please contact Murata engineering.

4. Cleaning

Following conditions should be observed when cleaning chip EMI filter.

(1) Cleaning Temperature: 60°C max. (40°C max. for alcohol type cleaner)

(2) Ultrasonic

Output: 20W/liter max.

Duration: 5 minutes max.

Frequency: 28 to 40kHz

Care should be taken not to cause resonance of the PCB and mounted products.

(3) Cleaning Agent

The following list of cleaning agents have been tested on the individual components. Evaluation of final assembly should be completed prior to production.

(a) Alcohol cleaning agent

Isopropyl alcohol (IPA)

(b) Aqueous cleaning agent

Pine Alpha ST-100S

(4) Ensure that flux residue is completely removed.

Component should be thoroughly dried after aqueous agent has been removed with deionized water.

△Note • Please read rating and △CAUTION (for storage, operating, rating, soldering, mounting and handling) in this catalog to prevent smoking and/or burning, etc.
• This catalog has only typical specifications. Therefore, please approve our product specifications or transact the approval sheet for product specifications before ordering.

Minimum Quantity and Dimensions of 8mm Width Paper / Embossed Tape

(Common to Paper Tape / Embossed Tape)

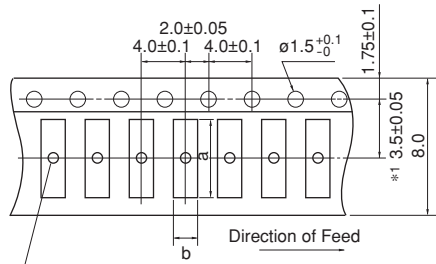

(There are holes in the cavities of the NFM31HK)
NFM31HK: $\phi 1.0^{+0.2}_{-0}$

*1 NFM31HK: 3.5 ± 0.1

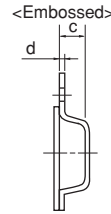

c: Depth of Cavity
(Embossed Tape)

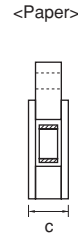

c: Total Thickness of Tape
(Paper Tape)

Dimension of the cavity of embossed tape is measured at the bottom side.

Part Number	Dimensions				Minimum Qty. (pcs.)				Bulk
					ø180mm Reel		ø330mm Reel		
	a	b	c	d	Paper Tape	Embossed Tape	Paper Tape	Embossed Tape	
NFL18ZT	1.85	1.05	0.9 max.	-	4000	-	-	-	1000
NFM21HC	2.3	1.55	1.1 max.	-	4000	-	-	-	500
NFM31HK	3.5	1.9	1.5	0.25	-	3000	-	-	500
NFE31ZT	3.6	1.8	1.85	0.2	-	2000	-	8000	500
NFZ32BW	2.9	3.6	1.7	0.2	-	2000	-	7500	-

(in mm)

Minimum Quantity and Dimensions of 12mm Width Embossed Tape

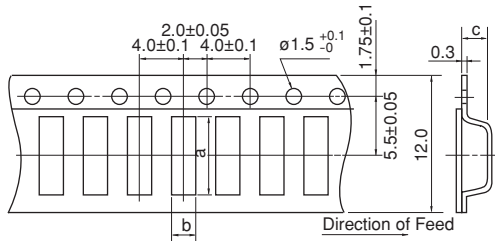

c: Depth of Cavity

Dimension of the cavity is measured at the bottom side.

Part Number	Dimensions			Minimum Qty. (pcs.)		
	a	b	c	ø180mm Reel	ø330mm Reel	Bulk
NFE61HT	7.2	1.9	1.75	2500	8000	500

(in mm)

"Minimum Quantity" means the number of units of each delivery or order. The quantity should be an integral multiple of the "Minimum Quantity."

Note • Please read rating and **CAUTION** (for storage, operating, rating, soldering, mounting and handling) in this catalog to prevent smoking and/or burning, etc.
• This catalog has only typical specifications. Therefore, please approve our product specifications or transact the approval sheet for product specifications before ordering.

DL Chip Common Mode Choke Coil Part Numbering



① Product ID

Product ID	
DL	Chip Common Mode Choke Coils

② Structure

Code	Structure
W	Wire Wound Type
M	Multilayer Type

③ Dimensions (L×W)

Code	Dimensions (L×W)	EIA
11	1.25×1.0mm	0504
21	2.0×1.2mm	0805
31	3.2×1.6mm	1206
43	4.5×3.2mm	1812
5A	5.0×3.6mm	2014
5B	5.0×5.0mm	2020

④ Features (1)

Code	Type
S	Magnetically Shielded One Circuit Type
T	One Circuit Low Profile Type

⑤ Category (DLW Series)

Code	Category	
Z	For Automotive	Infotainment
H		Powertrain, Safety

⑤ Category (DLM Series)

Code	Category
N	For General

⑩ Packaging

Code	Packaging	Series
K	Embossed Taping (ø330mm Reel)	DLW43S/DLW5AT/DLW5BS/DLW5BT
L	Embossed Taping (ø180mm Reel)	All Series
B	Bulk	All Series

⑥ Impedance

Typical impedance at 100MHz is expressed by three figures. The unit is in ohm (Ω). The first and second figures are significant digits, and the third figure expresses the number of zeros that follow the two figures.

⑥ Inductance (DLW43SH)

Expressed by three figures. The unit is micro-henry (μH). The first and second figures are significant digits, and the third figure expresses the number of zeros which follow the two figures.

⑦ Circuit

Code	Circuit
S	Expressed by a letter.
M	
H	
T	
X	

⑧ Features (2) (DLW Series)

Code	Features
K	Expressed by a letter.
P	
Q	

⑧ Features (2) (DLM Series)

Code	Features	
Z	For Automotive	Infotainment

⑨ Number of Signal Lines

Code	Number of Signal Lines
2	Two Lines

⚠Note • Please read rating and ⚠CAUTION (for storage, operating, rating, soldering, mounting and handling) in this catalog to prevent smoking and/or burning, etc.
• This catalog has only typical specifications. Therefore, please approve our product specifications or transact the approval sheet for product specifications before ordering.



PL

Common Mode Choke Coil

Part Numbering

(Part Number)

PL	T	10H	H	102	6R0	P	N	B
1	2	3	4	5	6	7	8	9

1 Product ID

Product ID	
PL	Common Mode Choke Coils

2 Type

Code	Type
T	DC Type

3 Applications

Code	Applications
10H	For DC Line High-frequency Type
5BP	5.0×5.0mm Size, for DC Lines

4 Features (1)

Code	Features	
H	For Automotive	Powertrain, Safety

9 Packaging

Code	Packaging	Series
B	Bulk	PLT10H, PLT5BP
L	Embossed Taping (ø178mm/ø180mm Reel)	PLT10H, PLT5BP
K	Embossed Taping (ø330mm Reel)	PLT10H

5 Impedance

Expressed by three figures. The unit is ohm (Ω). The first and second figures are significant digits, and the third figure expresses the number of zeros that follow the two figures.

6 Rated Current

Expressed by three figures. The unit is ampere (A). The first and second figures are significant digits, and the third figure expresses the number of zeros that follow the two figures. A decimal point is expressed by the capital letter "R." In this case, all figures are significant digits.

7 Features (2)

Code	Features
P	Expressed by a letter.
S	

8 Lead Dimensions

Code	Lead Dimensions
N	No Lead Terminal (SMD)

Note • Please read rating and **CAUTION** (for storage, operating, rating, soldering, mounting and handling) in this catalog to prevent smoking and/or burning, etc.
• This catalog has only typical specifications. Therefore, please approve our product specifications or transact the approval sheet for product specifications before ordering.

DLW5BS_TQ Series 2020/5050 (inch/mm)

2020 size, wire-wound common mode choke coil for power lines.

Appearance/Dimensions

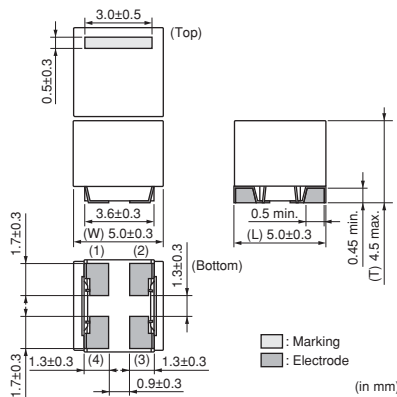

Packaging

Code	Packaging	Minimum Quantity
L	ø180mm Embossed Taping	400
K	ø330mm Embossed Taping	1500
B	Packing in Bulk	100



Equivalent Circuit

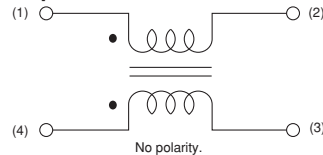

Refer to pages from p.117 to p.120 for mounting information.

Rated Value (□: packaging code)

Part Number		Common Mode Impedance (at 10MHz/20°C)	Common Mode Impedance (at 100MHz/20°C)	Rated Current	Rated Voltage	Insulation Resistance (min.)	Withstand Voltage	DC Resistance
For Infotainment	For Powertrain/Safety							
DLW5BSZ501TQ2□	—	2800Ω ±40%	500Ω (Typ.)	0.7A	50Vdc	10MΩ	125Vdc	0.23Ω max.
DLW5BSZ601TQ2□	—	1200Ω ±40%	600Ω (Typ.)	1.0A	50Vdc	10MΩ	125Vdc	0.12Ω max.
DLW5BSZ801TQ2□	—	550Ω ±40%	800Ω (Typ.)	1.5A	50Vdc	10MΩ	125Vdc	0.056Ω max.

Operating Temperature Range: -40°C~+105°C Number of Circuit: 1

Impedance-Frequency Characteristics (Main Items)

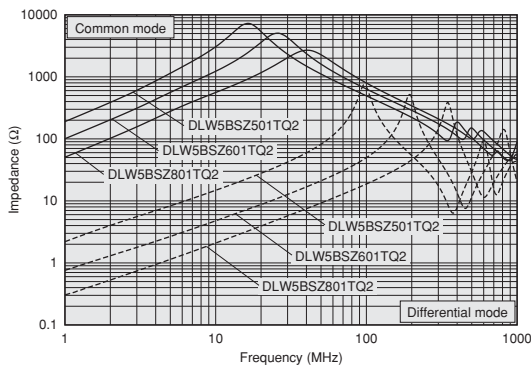

Note • Please read rating and CAUTION (for storage, operating, rating, soldering, mounting and handling) in this catalog to prevent smoking and/or burning, etc.
• This catalog has only typical specifications. Therefore, please approve our product specifications or transact the approval sheet for product specifications before ordering.

Chip Ferrite Bead SMD Type

Chip EMIFIL® SMD Type

Chip Common Mode Choke Coil SMD Type

Block Type EMIFIL® SMD Type

EMI Suppression Filters Lead Type

Microchip Transformer (Balun) SMD Type

DLW5AT/DLW5BT Series (105°C available type)

Low profile wire-wound common mode choke coil for power lines.

Appearance/Dimensions



DLW5AT_MQ2

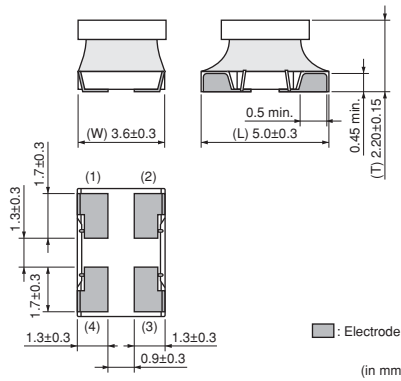

Packaging

Code	Packaging	Minimum Quantity
L	ø180mm Embossed Taping	700
K	ø330mm Embossed Taping	2500
B	Packing in Bulk	100

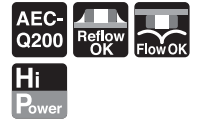

Equivalent Circuit

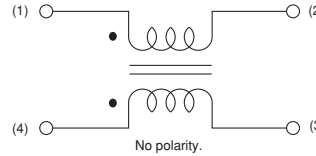

Appearance/Dimensions



DLW5AT_TQ2

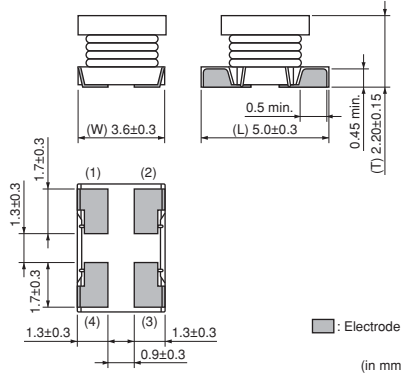

Packaging

Code	Packaging	Minimum Quantity
L	ø180mm Embossed Taping	700
K	ø330mm Embossed Taping	2500
B	Packing in Bulk	100



Equivalent Circuit

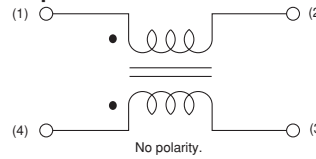

Appearance/Dimensions



DLW5BT_TQ2

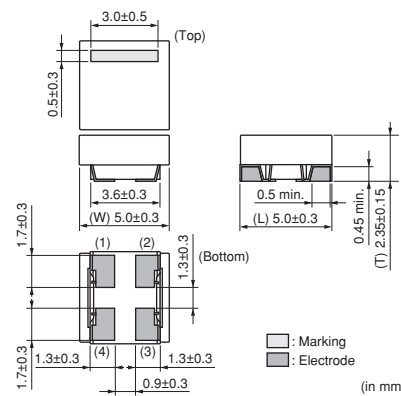

Packaging

Code	Packaging	Minimum Quantity
L	ø180mm Embossed Taping	700
K	ø330mm Embossed Taping	2500
B	Packing in Bulk	100



Equivalent Circuit

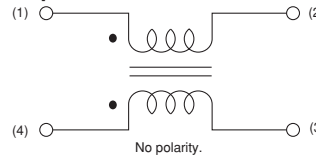

Refer to pages from p.117 to p.120 for mounting information.

Continued on the following page.

Note • Please read rating and **CAUTION** (for storage, operating, rating, soldering, mounting and handling) in this catalog to prevent smoking and/or burning, etc.
• This catalog has only typical specifications. Therefore, please approve our product specifications or transact the approval sheet for product specifications before ordering.

■ Rated Value (□: packaging code)

Part Number		Common Mode Impedance (at 100MHz/20°C)	Rated Current	Rated Voltage	Insulation Resistance (min.)	Withstand Voltage	DC Resistance
For Infotainment	For Powertrain/Safety						
DLW5ATZ500MQ2□	—	50 Ω (Typ.)	4A	50Vdc	10MΩ	125Vdc	0.013 Ω max.
DLW5ATZ151MQ2□	—	150 Ω (Typ.)	3A	50Vdc	10MΩ	125Vdc	0.020 Ω max.
DLW5ATZ331MQ2□	—	330 Ω (Typ.)	2.5A	50Vdc	10MΩ	125Vdc	0.027 Ω max.
DLW5ATZ501MQ2□	—	500 Ω (Typ.)	2A	50Vdc	10MΩ	125Vdc	0.034 Ω max.
DLW5ATZ112MQ2□	—	1100 Ω (Typ.)	1.5A	50Vdc	10MΩ	125Vdc	0.056 Ω max.
DLW5ATZ450TQ2□	—	45 Ω (Typ.)	4A	50Vdc	10MΩ	125Vdc	0.013 Ω max.
DLW5ATZ111TQ2□	—	110 Ω (Typ.)	3A	50Vdc	10MΩ	125Vdc	0.020 Ω max.
DLW5ATZ231TQ2□	—	230 Ω (Typ.)	2.5A	50Vdc	10MΩ	125Vdc	0.027 Ω max.
DLW5ATZ401TQ2□	—	400 Ω (Typ.)	2A	50Vdc	10MΩ	125Vdc	0.034 Ω max.
DLW5ATZ501TQ2□	—	500 Ω (Typ.)	1.5A	50Vdc	10MΩ	125Vdc	0.056 Ω max.
DLW5BTZ101TQ2□	—	100 Ω (Typ.)	4A	50Vdc	10MΩ	125Vdc	0.013 Ω max.
DLW5BTZ251TQ2□	—	250 Ω (Typ.)	3A	50Vdc	10MΩ	125Vdc	0.020 Ω max.
DLW5BTZ501TQ2□	—	500 Ω (Typ.)	2.5A	50Vdc	10MΩ	125Vdc	0.027 Ω max.
DLW5BTZ102TQ2□	—	1000 Ω (Typ.)	2A	50Vdc	10MΩ	125Vdc	0.034 Ω max.
DLW5BTZ142TQ2□	—	1400 Ω (Typ.)	1.5A	50Vdc	10MΩ	125Vdc	0.056 Ω max.

Operating Temperature Range: -40°C~+105°C Number of Circuit: 1

■ Impedance-Frequency Characteristics (Main Items)

DLW5AT_MQ2 Series

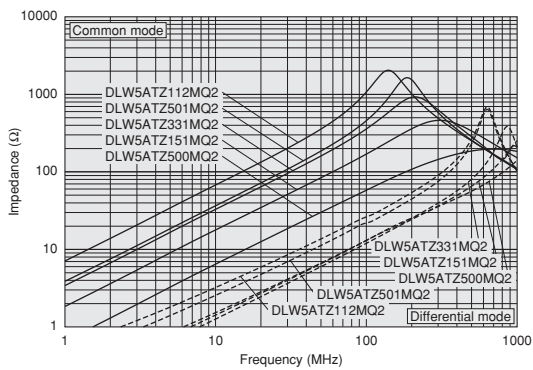

DLW5AT_TQ2 Series

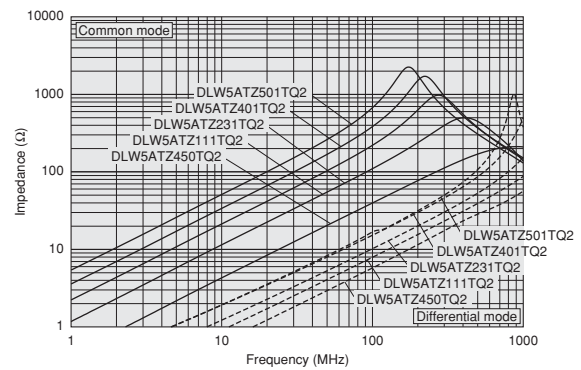

DLW5BT_TQ2 Series

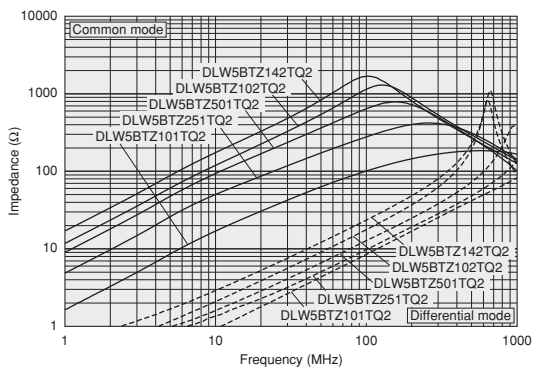

△Note • Please read rating and △CAUTION (for storage, operating, rating, soldering, mounting and handling) in this catalog to prevent smoking and/or burning, etc.
 • This catalog has only typical specifications. Therefore, please approve our product specifications or transact the approval sheet for product specifications before ordering.

Chip Ferrite Bead SMD Type
 Chip EMIFIL® SMD Type
 Chip Common Mode Choke Coil SMD Type
 Block Type EMIFIL® SMD Type
 EMI Suppression Filters Lead Type
 Microchip Transformer (Balun) SMD Type

DLM11S Series 0504/1210 (inch/mm)

0504 size multilayer type chip common mode choke coil.

Appearance/Dimensions

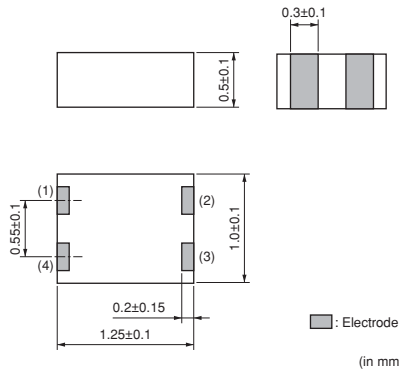

Packaging

Code	Packaging	Minimum Quantity
L	ø180mm Embossed Taping	4000
B	Packing in Bulk	500



Equivalent Circuit

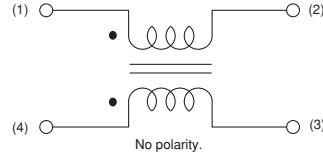

Refer to pages from p.117 to p.120 for mounting information.

Rated Value (□: packaging code)

Part Number		Common Mode Impedance (at 100MHz/20°C)	Rated Current	Rated Voltage	Insulation Resistance (min.)	Withstand Voltage	DC Resistance
For Infotainment	For Powertrain/Safety						
DLM11SN450HZ2□	—	45 Ω ±25%	100mA	5Vdc	100MΩ	12.5Vdc	0.7 Ω ±25%
DLM11SN900HZ2□	—	90 Ω ±25%	100mA	5Vdc	100MΩ	12.5Vdc	1.1 Ω ±25%

Operating Temperature Range: -55°C~+125°C Number of Circuit: 1

Impedance-Frequency Characteristics (Main Items)

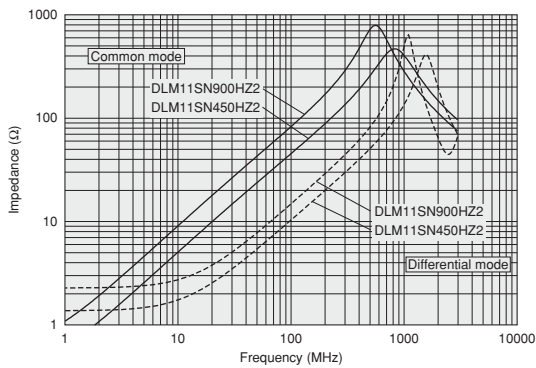

Differential Mode Transmission Characteristics (Typ.)

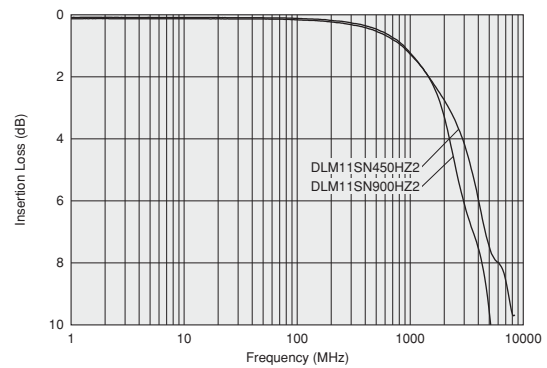

Note • Please read rating and CAUTION (for storage, operating, rating, soldering, mounting and handling) in this catalog to prevent smoking and/or burning, etc.
 • This catalog has only typical specifications. Therefore, please approve our product specifications or transact the approval sheet for product specifications before ordering.

DLW21S Series 0805/2012 (inch/mm)

0805 size, wire-wound common mode choke coil for high speed signal line.

■ Appearance/Dimensions

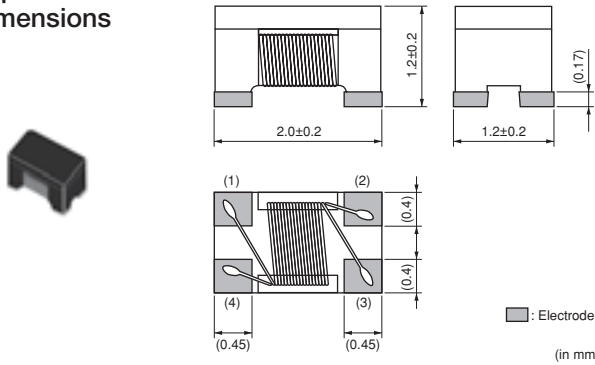

■ Packaging

Code	Packaging	Minimum Quantity
L	ø180mm Embossed Taping	2000
B	Packing in Bulk	500



■ Equivalent Circuit

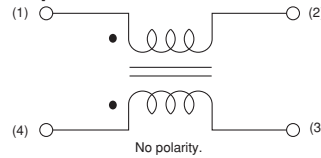

Refer to pages from p.117 to p.120 for mounting information.

■ Rated Value (□: packaging code)

Part Number		Common Mode Impedance (at 100MHz/20°C)	Rated Current	Rated Voltage	Insulation Resistance (min.)	Withstand Voltage	DC Resistance
For Infotainment	For Powertrain/Safety						
DLW21SZ670HQ2□	—	67 Ω ±25%	320mA	20Vdc	10MΩ	50Vdc	0.31 Ω max.
DLW21SZ900HQ2□	—	90 Ω ±25%	280mA	20Vdc	10MΩ	50Vdc	0.41 Ω max.
DLW21SZ121HQ2□	—	120 Ω ±25%	280mA	20Vdc	10MΩ	50Vdc	0.41 Ω max.

Operating Temperature Range: -40°C~+105°C Number of Circuit: 1

■ Impedance-Frequency Characteristics (Main Items)

DLW21SZ_HQ2 Series

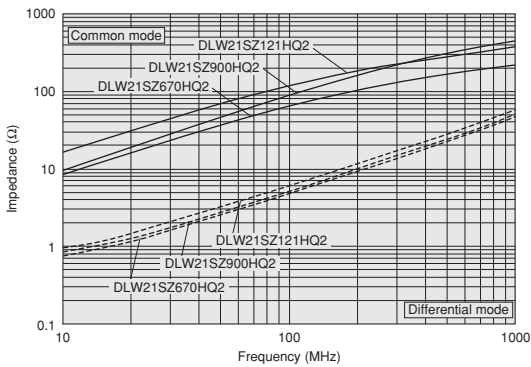

■ Differential Mode Transmission Characteristics (Typ.)

DLW21SZ_HQ2 Series

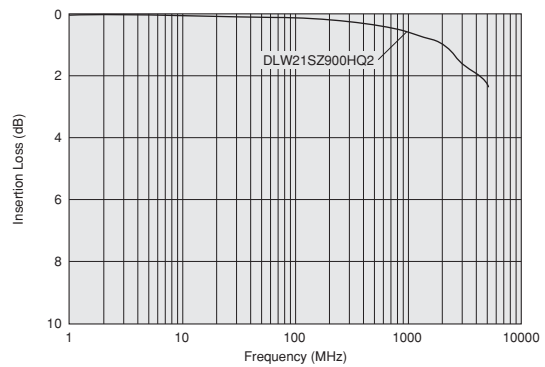

■ Rated Value (□: packaging code)

Part Number		Common Mode Impedance (at 100MHz/20°C)	Rated Current	Rated Voltage	Insulation Resistance (min.)	Withstand Voltage	DC Resistance
For Infotainment	For Powertrain/Safety						
DLW21SZ181XQ2□	—	180 Ω ±25%	240mA	20Vdc	10MΩ	50Vdc	0.39 Ω max.
DLW21SZ261XQ2□	—	260 Ω ±25%	220mA	20Vdc	10MΩ	50Vdc	0.59 Ω max.
DLW21SZ491XQ2□	—	490 Ω ±25%	190mA	20Vdc	10MΩ	50Vdc	0.77 Ω max.

Operating Temperature Range: -40°C~+105°C Number of Circuit: 1

Continued on the following page.

△Note • Please read rating and △CAUTION (for storage, operating, rating, soldering, mounting and handling) in this catalog to prevent smoking and/or burning, etc.
• This catalog has only typical specifications. Therefore, please approve our product specifications or transact the approval sheet for product specifications before ordering.

Chip Ferrite Bead SMD Type
 Chip EMIFIL® SMD Type
 Chip Common Mode Choke Coil SMD Type
 Block Type EMIFIL® SMD Type
 EMI Suppression Filters Lead Type
 Microchip Transformer (Balun) SMD Type

■ Impedance-Frequency Characteristics (Main Items)

DLW21SZ_XQ2 Series

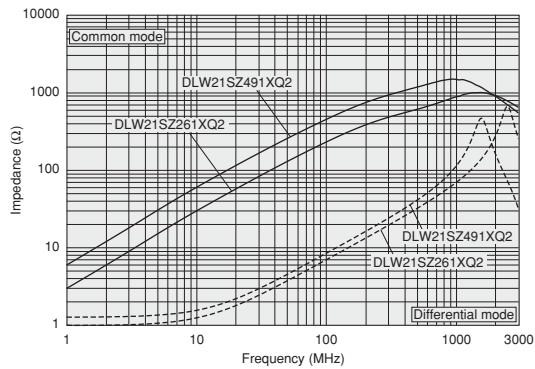

■ Differential Mode Transmission Characteristics (Typ.)

DLW21SZ_XQ2 Series

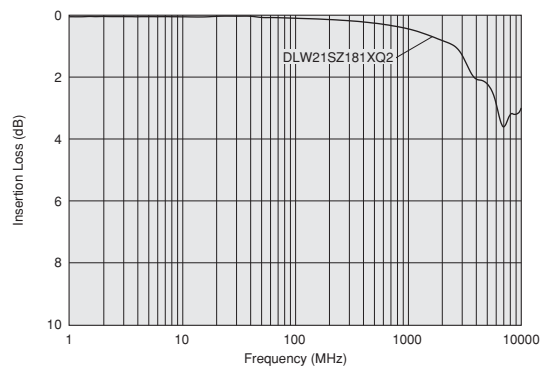

⚠Note • Please read rating and ⚠CAUTION (for storage, operating, rating, soldering, mounting and handling) in this catalog to prevent smoking and/or burning, etc.
• This catalog has only typical specifications. Therefore, please approve our product specifications or transact the approval sheet for product specifications before ordering.

DLW31S Series 1206/3216 (inch/mm)

1206 size wire-wound common mode choke coil.

Appearance/Dimensions

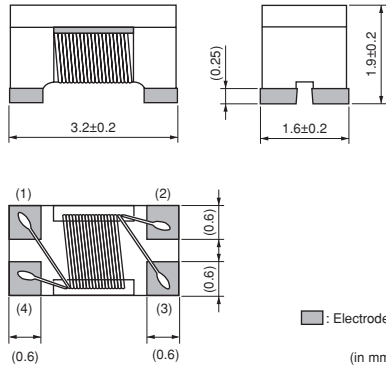

Packaging

Code	Packaging	Minimum Quantity
L	ø180mm Embossed Taping	2000
B	Packing in Bulk	500



Equivalent Circuit

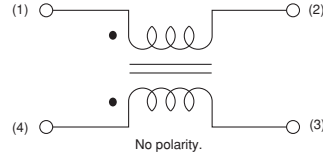

Refer to pages from p.117 to p.120 for mounting information.

Rated Value (□: packaging code)

Part Number		Common Mode Impedance (at 100MHz/20°C)	Rated Current	Rated Voltage	Insulation Resistance (min.)	Withstand Voltage	DC Resistance
For Infotainment	For Powertrain/Safety						
—	DLW31SH222SQ2□	2200Ω ±25%	80mA	32Vdc	10MΩ	80Vdc	1.6Ω ±20%

Operating Temperature Range: -40°C~+125°C Number of Circuit: 1

Impedance-Frequency Characteristics (Main Items)

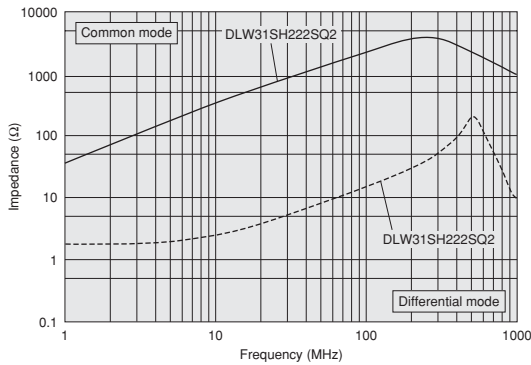

△Note • Please read rating and △CAUTION (for storage, operating, rating, soldering, mounting and handling) in this catalog to prevent smoking and/or burning, etc.
• This catalog has only typical specifications. Therefore, please approve our product specifications or transact the approval sheet for product specifications before ordering.

Chip Ferrite Bead SMD Type

Chip EMIFIL® SMD Type

Chip Common Mode Choke Coil SMD Type

Block Type EMIFIL® SMD Type

EMI Suppression Filters Lead Type

Microchip Transformer (Balun) SMD Type

DLW43S Series 1812/4532 (inch/mm)

1812 size wire-wound common mode choke coil.

Appearance/Dimensions



DLW43S_XK

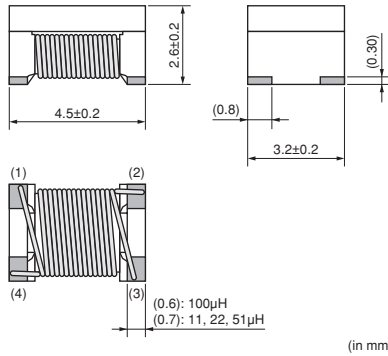

Packaging

Code	Packaging	Minimum Quantity
L	ø180mm Embossed Taping	500
K	ø330mm Embossed Taping	2500
B	Packing in Bulk	100



Equivalent Circuit

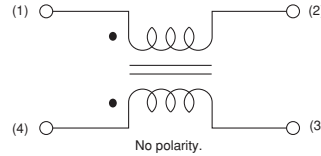

Appearance/Dimensions



DLW43S_XP

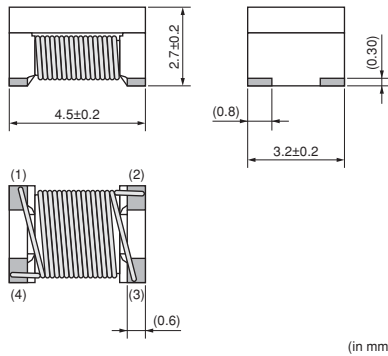

Packaging

Code	Packaging	Minimum Quantity
L	ø180mm Embossed Taping	500
K	ø330mm Embossed Taping	2500
B	Packing in Bulk	100



Equivalent Circuit

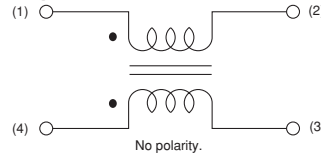

Refer to pages from p.117 to p.120 for mounting information.

Rated Value (□: packaging code)

Part Number		Common Mode Inductance	Rated Current	Rated Voltage	Insulation Resistance (min.)	Withstand Voltage	DC Resistance
For Infotainment	For Powertrain/Safety						
—	DLW43SH110XK2□	11µH -30%/+50% (at 0.1MHz)	360mA	50Vdc	10MΩ	125Vdc	0.5Ω max.
—	DLW43SH220XK2□	22µH -30%/+50% (at 0.1MHz)	310mA	50Vdc	10MΩ	125Vdc	0.6Ω max.
—	DLW43SH510XK2□	51µH -30%/+50% (at 1MHz)	230mA	50Vdc	10MΩ	125Vdc	1.0Ω max.
—	DLW43SH101XK2□	100µH -30%/+50% (at 1MHz)	200mA	50Vdc	10MΩ	125Vdc	2.0Ω max.
—	DLW43SH101XP2□	100µH -30%/+80% (at 0.1MHz)	170mA	50Vdc	10MΩ	125Vdc	2.0Ω max.

Operating Temperature Range: -40°C~+125°C Number of Circuit: 1

Impedance-Frequency Characteristics (Main Items)

DLW43S_XK Series

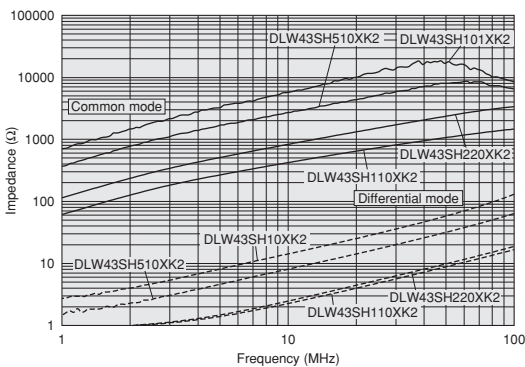

DLW43S_XP Series

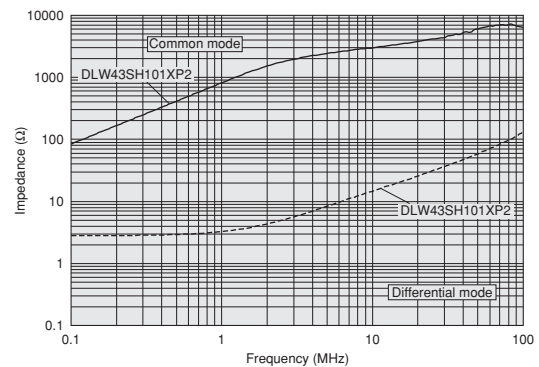

⚠Note • Please read rating and ⚠CAUTION (for storage, operating, rating, soldering, mounting and handling) in this catalog to prevent smoking and/or burning, etc.
• This catalog has only typical specifications. Therefore, please approve our product specifications or transact the approval sheet for product specifications before ordering.

SMD Type Chip Ferrite Bead
SMD Type Chip EMIFIL®
SMD Type Chip Common Mode Choke Coil
SMD Type Block Type EMIFIL®
Lead Type EMI Suppression Inductor
SMD Type Microchip Transformer (Balun)

PLT10H Series (12.9x6.6mm)

Meets large current up to 18A max.

■ Appearance/Dimensions

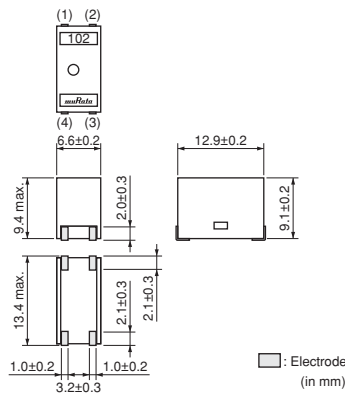

■ Packaging

Code	Packaging	Minimum Quantity
L	ø180mm Embossed Taping	125
K	ø330mm Embossed Taping	500
B	Packing in Bulk	50



■ Equivalent Circuit

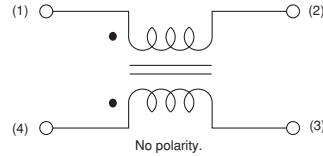

Refer to pages from p.121 to p.122 for mounting information.

■ Rated Value (□: packaging code)

Part Number		Common Mode Impedance (at 10MHz/20°C)	Rated Current	Rated Voltage	Insulation Resistance (min.)	Withstand Voltage	DC Resistance	Inductance
For Infotainment	For Powertrain/Safety							
—	PLT10HH450180PN□	45 Ω (Typ.)	18A	300Vdc	10MΩ	750Vdc	1.3mΩ ±0.5mΩ	0.8μH min.
—	PLT10HH101150PN□	100 Ω (Typ.)	15A	300Vdc	10MΩ	750Vdc	1.8mΩ ±0.5mΩ	2.0μH min.
—	PLT10HH401100PN□	400 Ω (Typ.)	10A	100Vdc	10MΩ	250Vdc	3.6mΩ ±0.5mΩ	6μH min.
—	PLT10HH501100PN□	500 Ω (Typ.)	10A	100Vdc	10MΩ	250Vdc	3.6mΩ ±0.5mΩ	9μH min.
—	PLT10HH9016R0PN□	900 Ω (Typ.)	6A	100Vdc	10MΩ	250Vdc	8.0mΩ ±0.5mΩ	14μH min.
—	PLT10HH1026R0PN□	1000 Ω (Typ.)	6A	100Vdc	10MΩ	250Vdc	8.0mΩ ±0.5mΩ	20μH min.

Operating Temperature Range (Self-temperature rise is included): -55°C~+105°C (PLT10HH 501100/1026R0 PN), -55°C~+125°C (PLT10HH 450180/101150/401100/9016R0 PN)
Number of Circuit: 1

■ Impedance-Frequency Characteristics (Main Items)

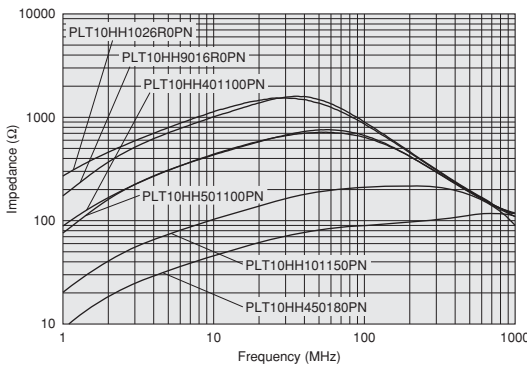

■ Derating of Rated Current

In operating temperature exceeding +65°C, derating of current is necessary for PLT10H series.

Please apply the derating curve shown in chart according to the operating temperature.

Derating of Rated Current

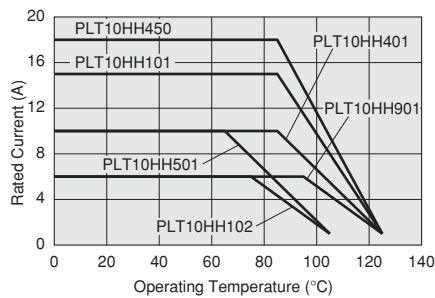

△Note • Please read rating and △CAUTION (for storage, operating, rating, soldering, mounting and handling) in this catalog to prevent smoking and/or burning, etc.
• This catalog has only typical specifications. Therefore, please approve our product specifications or transact the approval sheet for product specifications before ordering.

Chip Ferrite Bead
SMD Type

Chip EMIFIL®
SMD Type

Chip Common Mode Choke Coil
SMD Type

Block Type EMIFIL®
SMD Type

EMI Suppression Filters
Lead Type

Microchip Transformer (Balun)
SMD Type

PLT5BP Series 2020/5050 (inch/mm)

150°C available, 2020 size, for power lines.

Appearance/Dimensions

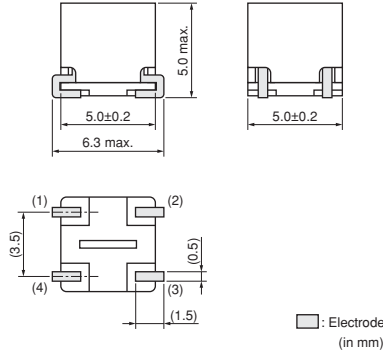

Packaging

Code	Packaging	Minimum Quantity
L	ø180mm Embossed Taping	300
B	Packing in Bulk	50



Equivalent Circuit

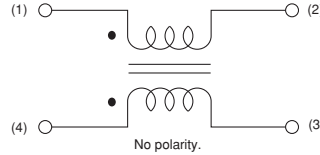

Refer to pages from p.121 to p.122 for mounting information.

Rated Value (□: packaging code)

Part Number		Common Mode Impedance (at 10MHz/20°C)	Rated Current	Rated Voltage	Insulation Resistance (min.)	Withstand Voltage	DC Resistance
For Infotainment	For Powertrain/Safety						
—	PLT5BPH1015R6SN□	100Ω (Typ.)	5.6A	80Vdc	10MΩ	200Vdc	4mΩ ±30%
—	PLT5BPH2014R4SN□	200Ω (Typ.)	4.4A	80Vdc	10MΩ	200Vdc	7mΩ ±30%
—	PLT5BPH3013R7SN□	300Ω (Typ.)	3.7A	80Vdc	10MΩ	200Vdc	11mΩ ±30%
—	PLT5BPH5013R1SN□	500Ω (Typ.)	3.1A	80Vdc	10MΩ	200Vdc	17mΩ ±30%

Operating Temperature Range: -55°C~+150°C Number of Circuit: 1

Impedance-Frequency Characteristics (Main Items)

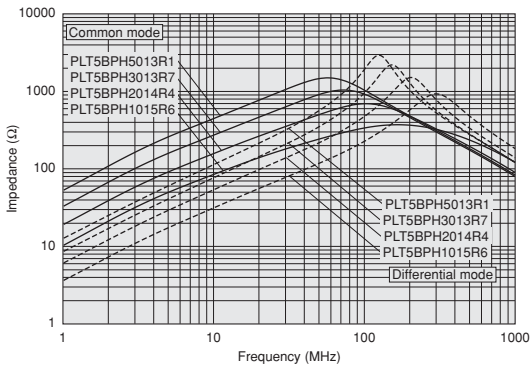

Derating of Rated Current

In operating temperature exceeding +125°C, derating of current is necessary for PLT5BP series. Please apply the derating curve shown in chart according to the operating temperature.

Derating of Rated Current

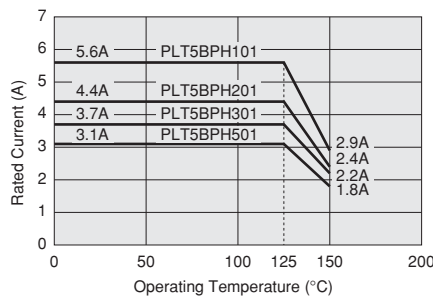

Note • Please read rating and CAUTION (for storage, operating, rating, soldering, mounting and handling) in this catalog to prevent smoking and/or burning, etc.
 • This catalog has only typical specifications. Therefore, please approve our product specifications or transact the approval sheet for product specifications before ordering.

⚠ Caution

● Rating

Do not use products beyond the rated current and rated voltage as this may create excessive heat and deteriorate the insulation resistance. Be sure to provide an appropriate fail-safe function on your product to prevent a second damage that may be caused by the abnormal function or the failure our product.

● Soldering and Mounting

1. Self-heating

Please provide special attention when mounting chip common mode choke coils DLW5 series in close proximity to other products that radiate heat. The heat generated by other products may deteriorate the insulation resistance and cause excessive heat in this component.

2. Mounting Direction

Mount Chip Common Mode Choke Coils in right direction. Wrong direction, which is 90 degrees rotated from right direction, causes not only open or short circuit but also flames or other serious trouble.

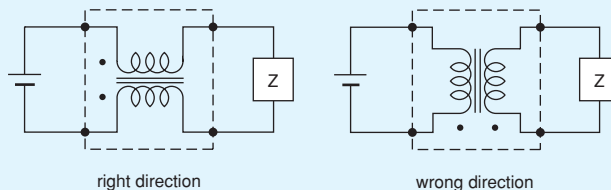

Notice

● Storage and Operating Conditions

<Operating Environment>

Do not use products in a chemical atmosphere such as chlorine gas, acid or sulfide gas.

Do not use products in the environment close to the organic solvent.

<Storage and Handling Requirements>

1. Storage Period

The DL series should be used within 12 months. Solderability should be checked if this period is exceeded.

2. Storage Conditions

- (1) Storage temperature: -10 to +40°C
Relative humidity: 15 to 85%
Avoid sudden changes in temperature and humidity.
- (2) Do not store products in a chemical atmosphere such as chlorine gas, acid or sulfide gas.

● Notice (Soldering and Mounting)

1. Cleaning

Failure and degradation of a product are caused by the cleaning method. When you clean in conditions that are not in mounting information, please contact Murata engineering.

2. Soldering

Reliability decreases with improper soldering methods. Please solder by the standard soldering conditions shown in mounting information.

3. Other

Noise suppression levels resulting from Murata's EMI suppression filters EMIFIL® may vary, depending on the circuits and ICs used, type of noise, mounting pattern, mounting location, and other operating conditions. Be sure to check and confirm in advance the noise suppression effect of each filter, in actual circuits, etc. before applying the filter in a commercial-purpose equipment design.

● Handling

1. Resin Coating (Except for DLW Series.)

Using resin for coating/molding products may affect the products performance.

So please pay careful attention in selecting resin. Prior to use, please make the reliability evaluation with the product mounted in your application set.

2. Resin Coating (DLW31S Series)

Do not make any resin coating DLW31S series. The impedance value may change due to high cure-stress of resin to be used for coating/molding products.

An open circuit issue may occur by mechanical stress caused by the resin, amount/cured shape of resin, or operating condition etc. Some resin contains some impurities or chloride possible to generate chlorine by hydrolysis under some operating condition may cause corrosion of wire of coil, leading to open circuit.

So, please pay your careful attention in selecting resin in case of coating/molding the products with the resin.

3. Resin Coating (Except DLW31S Series)

The impedance value may change due to high cure-stress of resin to be used for coating/molding products. An open circuit issue may occur by mechanical stress caused by the resin, amount/cured shape of resin, or operating condition etc. Some resin contains some impurities or chloride possible to generate chlorine by hydrolysis under some operating condition may cause corrosion of wire of coil, leading to open circuit.

So, please pay your careful attention in selecting resin in case of coating/molding the products with the resin. Prior to use the coating resin, please make sure no reliability issue is observed by evaluating products mounted on your board.

Continued on the following page. ↗

⚠ Note • Please read rating and ⚠ CAUTION (for storage, operating, rating, soldering, mounting and handling) in this catalog to prevent smoking and/or burning, etc.
• This catalog has only typical specifications. Therefore, please approve our product specifications or transact the approval sheet for product specifications before ordering.

4. Caution for Use (DLW Series)

When you hold products with a tweezer, please hold by the sides. Sharp materials, such as a pair of tweezers, should not touch the winding portion to prevent breaking the wire. Mechanical shock should not be applied to the products mounted on the board to prevent breaking the core.

5. Brushing (DLW21S/DLW31S/DLW43S Series)

When you clean the neighborhood of products such as connector pins, bristles of cleaning brush shall not be touched to the winding portion of this product to prevent the breaking of wire.

6. Handling of a Substrate

After mounting products on a substrate, do not apply any stress to the product caused by bending or twisting to the substrate when cropping the substrate, inserting and removing a connector from the substrate or tightening screw to the substrate. Excessive mechanical stress may cause cracking in the Product.

Bending

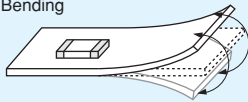

Twisting

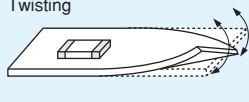

⚠ Note • Please read rating and ⚠ CAUTION (for storage, operating, rating, soldering, mounting and handling) in this catalog to prevent smoking and/or burning, etc.
• This catalog has only typical specifications. Therefore, please approve our product specifications or transact the approval sheet for product specifications before ordering.

⚠ Caution

● Rating

1. Do not use products beyond the rated current and rated voltage as this may create excessive heat and deteriorate the insulation resistance.
2. Be sure to provide an appropriate fail-safe function on your product to prevent a second damage that may be caused by the abnormal function or the failure our product.

● Soldering and Mounting

1. Self-heating

Please provide special attention when mounting chip common mode choke coils in close proximity to other products that radiate heat. The heat generated by other products may deteriorate the insulation resistance and cause excessive heat in this component.

2. Mounting Direction

Mount Chip Common Mode Choke Coils in right direction. Wrong direction, which is 90 degrees rotated from right direction, causes not only open or short circuit but also flames or other serious trouble.

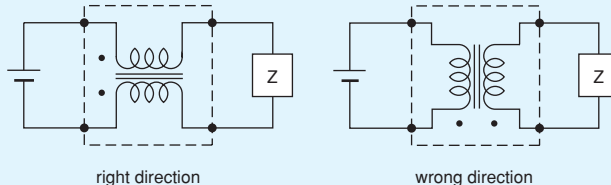

● Storage and Operating Conditions

<Operating Environment>

Do not use products in a chemical atmosphere such as chlorine gas, acid or sulfide gas. Do not use products in the environment close to the organic solvent.

<Storage and Handling Requirements>

1. Storage Period

PLT10H series, PLT5BP series should be used within 12 months. Solderability should be checked if this period is exceeded.

2. Storage Conditions

- (1) Storage temperature: -10 to +40°C
Relative humidity: 15 to 85%
Avoid sudden changes in temperature and humidity.
- (2) Do not store products in a chemical atmosphere such as chlorine gas, acid or sulfide gas.

● Notice (Soldering and Mounting)

1. Cleaning

Failure and degradation of a product are caused by the cleaning method. When you clean in conditions that are not in mounting information, please contact Murata engineering.

2. Soldering

Reliability decreases with improper soldering methods. Please solder by the standard soldering conditions shown in mounting information.

3. Other

Noise suppression levels resulting from Murata's EMI suppression filters EMIFIL® may vary, depending on the circuits and ICs used, type of noise, mounting pattern, mounting location, and other operating conditions. Be sure to check and confirm in advance the noise suppression effect of each filter, in actual circuits, etc. before applying the filter in a commercial-purpose equipment design.

● Handling

1. Handling of a Substrate

After mounting products on a substrate, do not apply any stress to the product caused by bending or twisting to the substrate when cropping the substrate, inserting and removing a connector from the substrate or tightening screw to the substrate. Excessive mechanical stress may cause cracking in the Product.

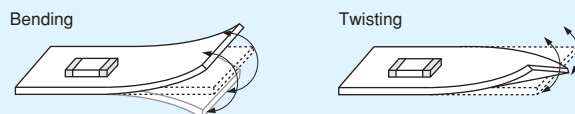

Notice

⚠ Note • Please read rating and ⚠ CAUTION (for storage, operating, rating, soldering, mounting and handling) in this catalog to prevent smoking and/or burning, etc.
• This catalog has only typical specifications. Therefore, please approve our product specifications or transact the approval sheet for product specifications before ordering.

1. Standard Land Pattern Dimensions

 Land Pattern + Solder Resist
 Land Pattern
 Solder Resist (in mm)

DLM11S
 DLW21S
 DLW31S
 DLW43S
 DLW5A
 DLW5B

● Reflow Soldering

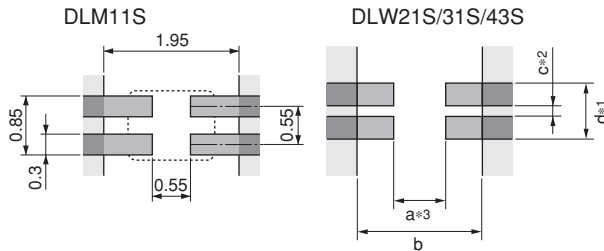

Series	a	b	c	d
DLW21S/H	0.8	2.6	0.4	1.2
DLW31S	1.6	3.7	0.4	1.6
DLW43SH110/220/510	3.0	5.9	1.6	3.4
DLW43SH101	3.2	5.9	1.6	3.4

- *1: If the pattern is made with wider than 1.2mm (DLW21) / 1.6mm (DLW31S) it may result in components turning around, because melting speed is different. In the worst case, short circuit between lines may occur.
 - *2: If the pattern is made with less than specified dimensions, in the worst case, short circuit between lines may occur due to spread of soldering paste or mount placing accuracy.
 - *3: If the pattern is made with wider than 0.8mm (DLW21) / 1.6mm (DLW31SN), the bending strength will be reduced. Moreover, if the pattern is made with less than "a" dimension, in the worst case short circuit may be occurred. (DLW43S)
- Do not use gild pattern; excess soldering heat may dissolve metal of a copper wire.

DLW5A/5B (Except for DLW5AT_MQ2)

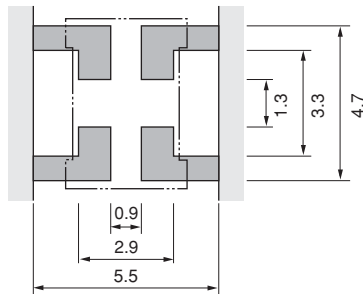

DLW5AT_MQ2

● Reflow Soldering Chip Mounting Side

DLW5AT_MQ2

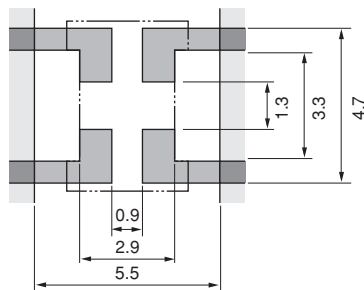

● Flow Soldering Chip Mounting Side

DLW5AT_MQ2

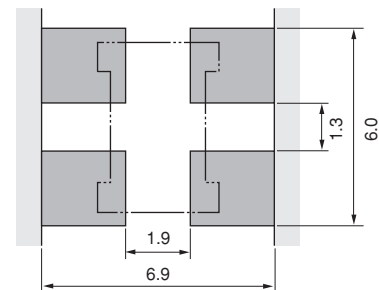

● PCB Warping

PCB should be designed so that products are not subjected to the mechanical stress caused by warping the board.

Products should be located in the sideways direction (Length: $a < b$) to the mechanical stress.

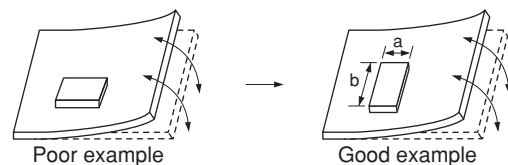

⚠Note • Please read rating and ⚠CAUTION (for storage, operating, rating, soldering, mounting and handling) in this catalog to prevent smoking and/or burning, etc.
 • This catalog has only typical specifications. Therefore, please approve our product specifications or transact the approval sheet for product specifications before ordering.

SMD Type Chip Ferrite Bead
 SMD Type Chip EMIFIL®
 Chip Common Mode Choke Coil Soldering and Mounting
 SMD Type Block Type EMIFIL®
 Lead Type EMI Suppression Filters
 SMD Type Microchip Transformer (Balun)

2. Solder Paste Printing and Adhesive Application

When reflow soldering the chip common mode choke coils, the printing must be conducted in accordance with the following cream solder printing conditions.

If too much solder is applied, the chip will be prone to damage by mechanical and thermal stress from the PCB and may crack.

Standard land dimensions should be used for resist and copper foil patterns.

When flow soldering the chip common mode choke coils, apply the adhesive in accordance with the following conditions.

If too much adhesive is applied, then it may overflow into the land or termination areas and yield poor solderability.

In contrast, if insufficient adhesive is applied, or if the adhesive is not sufficiently hardened, then the chip may become detached during flow soldering process.

(in mm)

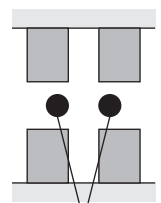
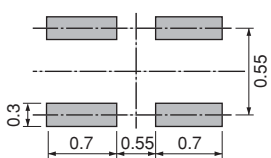
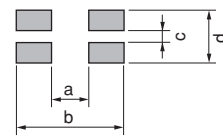
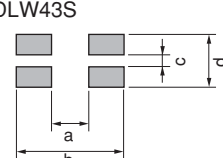
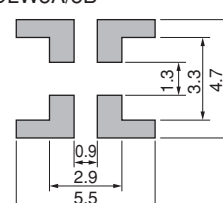
Series	Solder Paste Printing	Adhesive Application															
DLW DLM	<p>●Guideline of solder paste thickness: 100-150μm: DLW21S/31S, DLM11S 150μm: DLW43S 150-200μm: DLW5A/5B</p> <p>*Solderability is subject to reflow conditions and thermal conductivity. Please make sure that your product has been evaluated in view of your specifications with our product being mounted to your product.</p>	<p>■ DLW5AT_MQ2 Apply 0.3mg of bonding agent at each chip.</p>  <p>DLW5AT_MQ2 Coating Position of Bonding Agent</p>															
	<p>DLM11S</p> 																
	<p>DLW21S/31S</p> 	<table border="1"> <thead> <tr> <th>Series</th> <th>a</th> <th>b</th> <th>c</th> <th>d</th> </tr> </thead> <tbody> <tr> <td>DLW21S</td> <td>0.8</td> <td>2.6</td> <td>0.5</td> <td>1.2</td> </tr> <tr> <td>DLW31S</td> <td>1.6</td> <td>3.7</td> <td>0.4</td> <td>1.6</td> </tr> </tbody> </table>	Series	a	b	c	d	DLW21S	0.8	2.6	0.5	1.2	DLW31S	1.6	3.7	0.4	1.6
	Series	a	b	c	d												
	DLW21S	0.8	2.6	0.5	1.2												
DLW31S	1.6	3.7	0.4	1.6													
<p>DLW43S</p> 	<table border="1"> <thead> <tr> <th>Series</th> <th>a</th> <th>b</th> <th>c</th> <th>d</th> </tr> </thead> <tbody> <tr> <td rowspan="2">DLW43S</td> <td>3.0 (110/220/510)</td> <td rowspan="2">5.9</td> <td rowspan="2">1.6</td> <td rowspan="2">3.4</td> </tr> <tr> <td>3.2 (101)</td> </tr> </tbody> </table>	Series	a	b	c	d	DLW43S	3.0 (110/220/510)	5.9	1.6	3.4	3.2 (101)					
Series	a	b	c	d													
DLW43S	3.0 (110/220/510)	5.9	1.6	3.4													
	3.2 (101)																
<p>DLW5A/5B</p> 																	

△Note • Please read rating and △CAUTION (for storage, operating, rating, soldering, mounting and handling) in this catalog to prevent smoking and/or burning, etc.
 • This catalog has only typical specifications. Therefore, please approve our product specifications or transact the approval sheet for product specifications before ordering.

Chip Ferrite Bead SMD Type
 Chip EMIFIL® SMD Type
 Soldering and Mounting Chip Common Mode Choke Coil
 Block Type EMIFIL® SMD Type
 EMI Suppression Filters Lead Type
 Microchip Transformer (Balun) SMD Type

3. Standard Soldering Conditions

(1) Soldering Methods

Use flow and reflow soldering methods only.
 Use standard soldering conditions when soldering chip common mode choke coils.
 In cases where several different parts are soldered, each having different soldering conditions, use those conditions requiring the least heat and minimum time.

Solder: Use Sn-3.0Ag-0.5Cu solder. Use of Sn-Zn based solder will deteriorate performance of products.
 If using DLM series with Sn-Zn based solder, please contact Murata in advance.

Flux:

- Use Rosin-based flux.
 In case of DLW21/31/43 series, use Rosin-based flux with converting chlorine content of 0.06 to 0.1wt%.
 In case of using RA type solder, products should be cleaned completely with no residual flux.
- Do not use strong acidic flux (with chlorine content exceeding 0.20wt%)
- Do not use water-soluble flux.

For additional mounting methods, please contact Murata.

(2) Soldering Profile

● **Flow Soldering Profile**
 (Sn-3.0Ag-0.5Cu Solder)

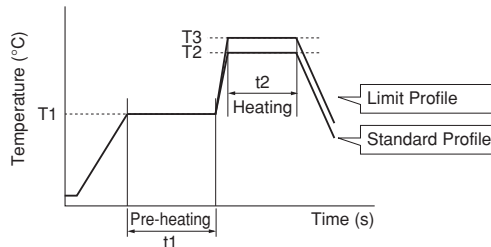

Series	Pre-heating		Standard Profile			Limit Profile		
	Temp. (T1)	Time. (t1)	Heating		Cycle of Flow	Heating		Cycle of Flow
			Temp. (T2)	Time. (t2)		Temp. (T3)	Time. (t2)	
DLW5AT_MQ2	150°C	60s min.	250°C	4 to 6s	2 times max.	265±3°C	5s max.	2 times max.

● **Reflow Soldering Profile**
 (Sn-3.0Ag-0.5Cu Solder)

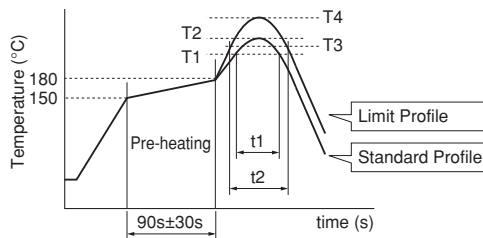

Series	Standard Profile				Limit Profile			
	Heating		Peak Temperature (T2)	Cycle of Reflow	Heating		Peak Temperature (T4)	Cycle of Reflow
	Temp. (T1)	Time. (t1)			Temp. (T3)	Time. (t2)		
DLM/ DLW21S/31S	220°C min.	30 to 60s	245±3°C	2 times max.	230°C min.	60s max.	260°C/10s	2 times max.
DLW43S	220°C min.	30 to 60s	245±3°C	2 times max.	240°C min.	30s max.	260°C/10s	2 times max.
DLW5A/5B	220°C min.	30 to 60s	250±3°C	2 times max.	230°C min.	60s max.	260°C/10s	2 times max.

△Note • Please read rating and △CAUTION (for storage, operating, rating, soldering, mounting and handling) in this catalog to prevent smoking and/or burning, etc.
 • This catalog has only typical specifications. Therefore, please approve our product specifications or transact the approval sheet for product specifications before ordering.

(3) Reworking with Solder Iron

The following conditions must be strictly followed when using a soldering iron.

Pre-heating: 150°C 60s min.

Soldering iron power output / Tip diameter:

30W max. / ø3mm max.

Temperature of soldering iron tip / Soldering time / Times:

350°C max. / 3-4s / 2 times*¹

*¹ DLW31S/DLW43S: 350°C max. / 3s / 2 times

Do not allow the tip of the soldering iron to directly contact the chip.

For additional methods of reworking with a soldering iron, please contact Murata engineering.

4. Cleaning

Following conditions should be observed when cleaning chip EMI filter.

Do not clean DLW series.

(1) Cleaning Temperature: 60°C max. (40°C max. for alcohol type cleaner)

(2) Ultrasonic

Output: 20W/liter max.

Duration: 5 minutes max.

Frequency: 28 to 40kHz

(3) Cleaning agent

The following list of cleaning agents have been tested on the individual components. Evaluation of final assembly should be completed prior to production.

Before cleaning, please contact Murata engineering.

(a) Alcohol cleaning agent

Isopropyl alcohol (IPA)

(b) Aqueous cleaning agent

Pine Alpha ST-100S

(4) Ensure that flux residue is completely removed.

Component should be thoroughly dried after aqueous agent has been removed with deionized water.

△Note • Please read rating and △CAUTION (for storage, operating, rating, soldering, mounting and handling) in this catalog to prevent smoking and/or burning, etc.
• This catalog has only typical specifications. Therefore, please approve our product specifications or transact the approval sheet for product specifications before ordering.

1. Standard Land Pattern Dimensions

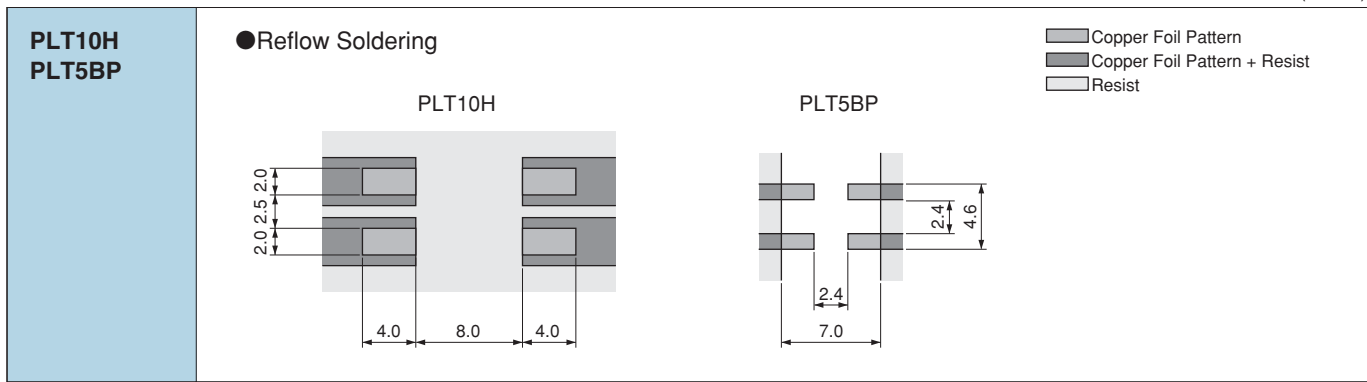

● PCB Warping
 PCB should be designed so that products are not subjected to the mechanical stress caused by warping the board.

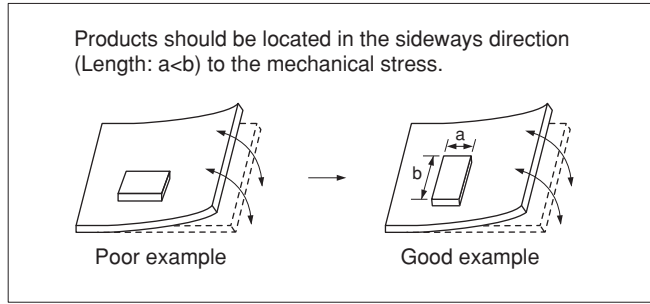

2. Solder Paste Printing and Adhesive Application

When reflow soldering the chip common mode choke coils, the printing must be conducted in accordance with the following cream solder printing conditions.
 If too much solder is applied, the chip will be prone to damage by mechanical and thermal stress from the PCB and may crack.
 Standard land dimensions should be used for resist and copper foil patterns.

When flow soldering the chip common mode choke coils, apply the adhesive in accordance with the following conditions.
 If too much adhesive is applied, then it may overflow into the land or termination areas and yield poor solderability.
 In contrast, if insufficient adhesive is applied, or if the adhesive is not sufficiently hardened, then the chip may become detached during flow soldering process.

Series	Solder Paste Printing
PLT10H PLT5BP	<p>●Guideline of solder paste thickness: 150-200μm: PLT10H 150μm: PLT5BP For the solder paste printing pattern, use standard land dimensions.</p> <p><i>*Solderability is subject to reflow conditions and thermal conductivity. Please make sure that your product has been evaluated in view of your specifications with our product being mounted to your product.</i></p>

⚠Note • Please read rating and ⚠CAUTION (for storage, operating, rating, soldering, mounting and handling) in this catalog to prevent smoking and/or burning, etc.
 • This catalog has only typical specifications. Therefore, please approve our product specifications or transact the approval sheet for product specifications before ordering.

SMD Type Chip Ferrite Bead
 SMD Type Chip EMIFIL®
 Chip Common Mode Choke Coil Soldering and Mounting
 SMD Type Block Type EMIFIL®
 Lead Type EMI Suppression Filters
 SMD Type Microchip Transformer (Balun)

3. Standard Soldering Conditions

(1) Soldering Methods

Use reflow soldering methods only.
 Use standard soldering conditions when soldering chip common mode choke coils.
 In cases where several different parts are soldered, each having different soldering conditions, use those conditions requiring the least heat and minimum time.

Solder: Use Sn-3.0Ag-0.5Cu solder. Use of Sn-Zn based solder will deteriorate performance of products.

Flux:

- Use Rosin-based flux.
- Do not use strong acidic flux (with chlorine content exceeding 0.20wt%)
- Do not use water-soluble flux.

For additional mounting methods, please contact Murata.

(2) Soldering Profile

● Reflow Soldering Profile
 (Sn-3.0Ag-0.5Cu Solder)

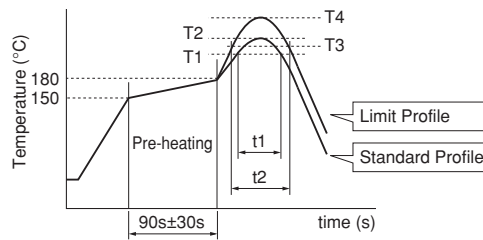

Series	Standard Profile				Limit Profile			
	Heating		Peak Temperature (T2)	Cycle of Reflow	Heating		Peak Temperature (T4)	Cycle of Reflow
	Temp. (T1)	Time. (t1)			Temp. (T3)	Time. (t2)		
PLT10H	220°C min.	30 to 60s	250±3°C	2 times max.	230°C min.	60s max.	260°C/10s	2 times max.
PLT5BP	220°C min.	30 to 60s	245±3°C	2 times max.	240°C min.	30s max.	260°C/10s	2 times max.

(3) Reworking with Solder Iron

The following conditions must be strictly followed when using a soldering iron.

Pre-heating: 150°C 60s min.

Soldering iron power output / Tip diameter:

80W max. / ø3mm max.: PLT10HH

30W max. / ø3mm max.: PLT5BP

Temperature of soldering iron tip / Soldering time / Times:

400°C max. / 5s / 2 times: PLT10HH

350°C max. / 3 to 4s / 2 times: PLT5BP

Do not allow the tip of the soldering iron to directly contact the chip.

For additional methods of reworking with a soldering iron, please contact Murata engineering.

4. Cleaning

Do not clean after soldering.

△Note • Please read rating and △CAUTION (for storage, operating, rating, soldering, mounting and handling) in this catalog to prevent smoking and/or burning, etc.
 • This catalog has only typical specifications. Therefore, please approve our product specifications or transact the approval sheet for product specifications before ordering.

Chip Ferrite Bead SMD Type
 Chip EMIFIL® SMD Type
 Soldering and Mounting Chip Common Mode Choke Coil
 Block Type EMIFIL® SMD Type
 EMI Suppression Filters Lead Type
 Microchip Transformer (Balun) SMD Type

■ Minimum Quantity and Dimensions of 8mm Width Embossed Tape

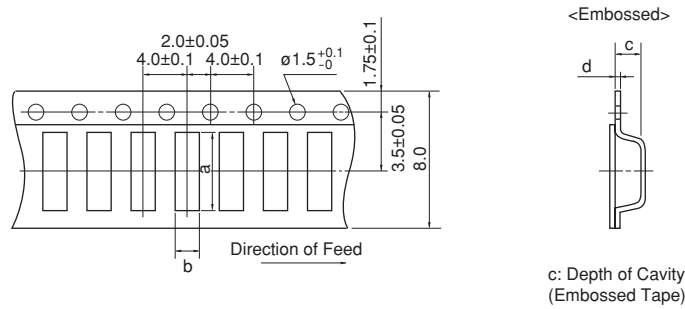

Dimension of the cavity of embossed tape is measured at the bottom side.

Part Number	Dimensions				Minimum Qty. (pcs.)				Bulk
					ø180mm Reel		ø330mm Reel		
	a	b	c	d	Paper Tape	Embossed Tape	Paper Tape	Embossed Tape	
DLM11S	1.4	1.15	0.65	0.25	-	4000	-	-	500
DLW21S	2.25	1.45	1.4	0.3	-	2000	-	-	500
DLW31S	3.6	2.0	2.1	0.3	-	2000	-	-	500

(in mm)

■ Minimum Quantity and Dimensions of 12mm Width Embossed Tape

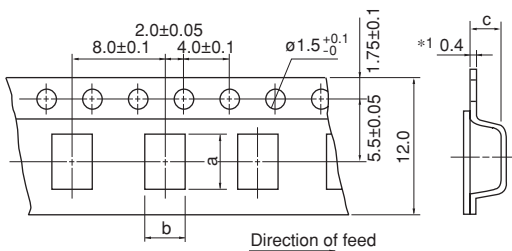

*1 DLW43/DLW5AT: 0.3 c: Depth of Cavity

Dimension of the cavity is measured at the bottom side.

Part Number	Dimensions			Minimum Qty. (pcs.)		
	a	b	c	ø180mm Reel	ø330mm Reel	Bulk
DLW43SH_XK	4.9	3.6	2.7	500	2500	100
DLW43SH_XP	4.9	3.6	2.9	500	2500	100
DLW5AT	5.4	4.1	2.7	700	2500	100
DLW5BS	5.5	5.4	4.7	400	1500	100
DLW5BT	5.5	5.5	2.7	700	2500	100

(in mm)

"Minimum Quantity" means the number of units of each delivery or order. The quantity should be an integral multiple of the "Minimum Quantity."

Note • Please read rating and **CAUTION** (for storage, operating, rating, soldering, mounting and handling) in this catalog to prevent smoking and/or burning, etc.
• This catalog has only typical specifications. Therefore, please approve our product specifications or transact the approval sheet for product specifications before ordering.

■ Minimum Quantity and Dimensions of 12mm Width Embossed Tape

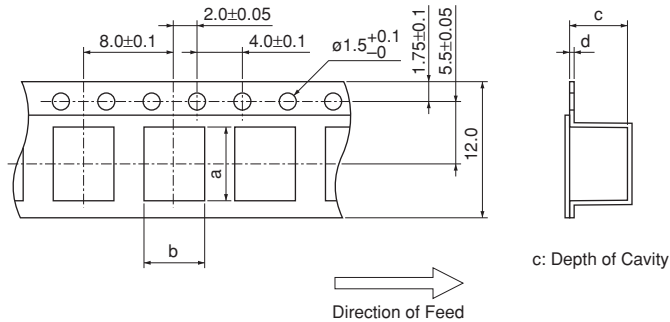

Dimension of the cavity is measured at the bottom side.

Part Number	Dimensions				Minimum Qty. (pcs.)		
	a	b	c	d	ø180mm Reel	ø330mm Reel	Bulk
PLT5BP	6.5	5.35	5.1	0.4	300	-	50

(in mm)

■ Minimum Quantity and Dimensions of 24mm Width Embossed Tape

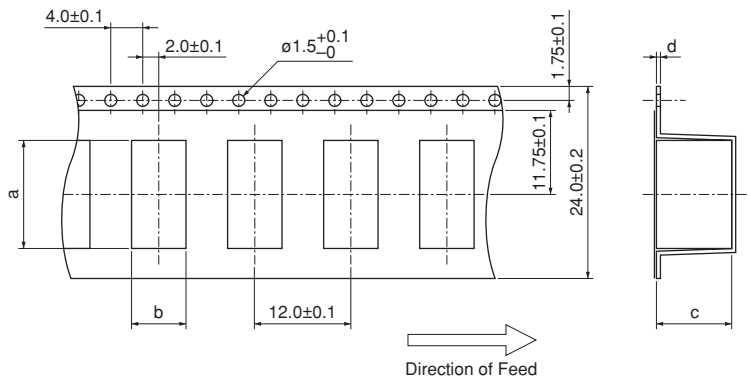

Dimension of the cavity is measured at the bottom side.

Part Number	Dimensions				Minimum Qty. (pcs.)		
	a	b	c	d	ø180mm Reel	ø330mm Reel	Bulk
PLT10H	13.5	6.8	9.4	0.5	125	500	50

(in mm)

⚠Note • Please read rating and ⚠CAUTION (for storage, operating, rating, soldering, mounting and handling) in this catalog to prevent smoking and/or burning, etc.
 • This catalog has only typical specifications. Therefore, please approve our product specifications or transact the approval sheet for product specifications before ordering.

Chip Ferrite Bead SMD Type
 Chip EMIFIL® SMD Type
 Packaging Chip Common Mode Choke Coil
 Block Type EMIFIL® SMD Type
 EMI Suppression Filters Lead Type
 Microchip Transformer (Balun) SMD Type

BNX02 Series

Wide noise suppression frequency range from 100kHz to several GHz is available. (SMD type)

Appearance/Dimensions

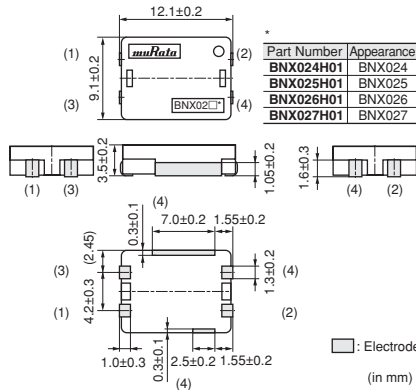

Packaging

Code	Packaging	Minimum Quantity
L	ø180mm Embossed Taping	400
K	ø330mm Embossed Taping	1500
B	Packing in Bulk	100



Equivalent Circuit

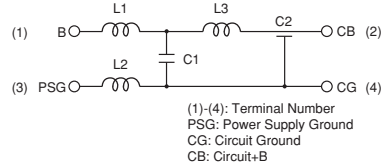

Refer to pages from p.128 to p.129 for mounting information.

Rated Value (□: packaging code)

Part Number		Rated Voltage	Withstand Voltage	Rated Current	Insulation Resistance (min.)	Insertion Loss
For Infotainment	For Powertrain/Safety					
—	BNX024H01□	50Vdc	125Vdc	15A	100MΩ	100kHz to 1GHz:35dB min. (Line impedance=50Ω)
—	BNX025H01□	25Vdc	62.5Vdc	15A	50MΩ	50kHz to 1GHz:35dB min. (Line impedance=50Ω)
—	BNX026H01□	50Vdc	125Vdc	15A	10MΩ	50kHz to 1GHz:35dB min. (Line impedance=50Ω)
—	BNX027H01□	16Vdc	40Vdc	15A	1MΩ	40kHz to 1GHz:35dB min. (Line impedance=50Ω)

Operating Temperature Range: -55°C~+125°C
 In operating temperatures exceeding +85°C, derating of current is necessary.

Insertion Loss Characteristics (Main Items)

BNX024H01

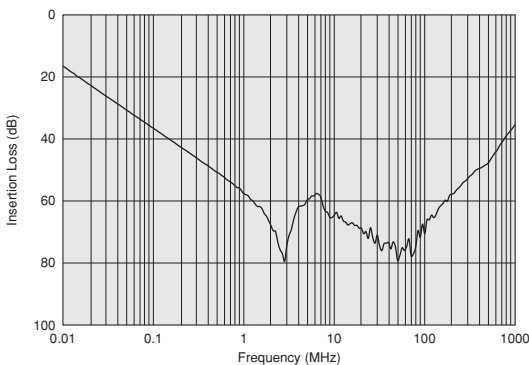

BNX025H01/BNX026H01

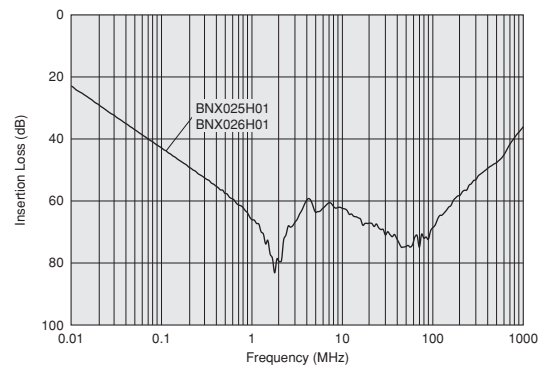

BNX027H01

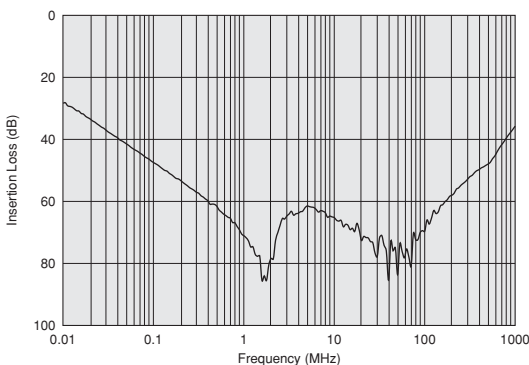

Continued on the following page.

⚠Note • Please read rating and ⚠CAUTION (for storage, operating, rating, soldering, mounting and handling) in this catalog to prevent smoking and/or burning, etc.
 • This catalog has only typical specifications. Therefore, please approve our product specifications or transact the approval sheet for product specifications before ordering.

SMD Type Chip Ferrite Bead
SMD Type Chip EMIFIL®
SMD Type Chip Common Mode Choke Coil
SMD Type Block Type EMIFIL®
Lead Type EMI Suppression Filters
SMD Type Microchip Transformer (Balun)

■ Derating of Rated current

In operating temperature exceeding +85°C, derating of current is necessary for BNX024H/025H/026H/027H series. Please apply the derating curve shown in chart according to the operating temperature.

Derating of Rated Current

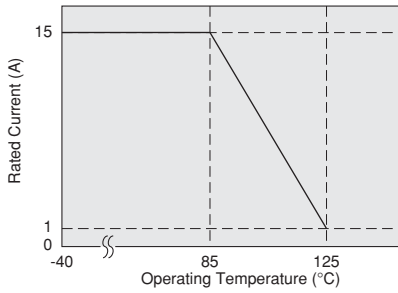

⚠Note • Please read rating and ⚠CAUTION (for storage, operating, rating, soldering, mounting and handling) in this catalog to prevent smoking and/or burning, etc.
• This catalog has only typical specifications. Therefore, please approve our product specifications or transact the approval sheet for product specifications before ordering.

⚠ Caution

● **Rating**

Do not use products beyond the rated current and rated voltage as this may create excessive heat and deteriorate the insulation resistance.

Notice

● **Storage and Operating Conditions**

<Operating Environment>

Do not use products in a chemical atmosphere such as chlorine gas, acid or sulfide gas.

Do not use products in the environment close to the organic solvent.

<Storage and Handling Requirements>

1. Storage Period

BNX series should be used within 12 months.
Solderability should be checked if this period is exceeded.

2. Storage Conditions

- (1) Storage temperature: -10 to +40°C
Relative humidity: 15 to 85%
Avoid sudden changes in temperature and humidity.
- (2) Do not store products in a chemical atmosphere such as chlorine gas, acid or sulfide gas.

● **Notice (Soldering and Mounting)**

1. Cleaning

Do not clean BNX series (SMD Type).

2. Soldering

Reliability decreases with improper soldering methods.
Please solder by the standard soldering conditions shown in mounting information.

3. Other

Noise suppression levels resulting from Murata's EMI suppression filters EMIFIL[®] may vary, depending on the circuits and ICs used, type of noise, mounting pattern, mounting location, and other operating conditions. Be sure to check and confirm in advance the noise suppression effect of each filter, in actual circuits, etc. before applying the filter in a commercial-purpose equipment design.

● **Handling**

1. Resin Coating

Using resin for coating/molding products may affect the products performance.
So please pay careful attention in selecting resin.
Prior to use, please make the reliability evaluation with the product mounted in your application set.

2. Handling of a Substrate (for BNX02□)

After mounting products on a substrate, do not apply any stress to the product caused by bending or twisting to the substrate when cropping the substrate, inserting and removing a connector from the substrate or tightening screw to the substrate.
Excessive mechanical stress may cause cracking in the Product.

Bending

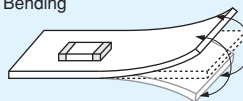

Twisting

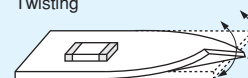

⚠ Note • Please read rating and ⚠ CAUTION (for storage, operating, rating, soldering, mounting and handling) in this catalog to prevent smoking and/or burning, etc.
• This catalog has only typical specifications. Therefore, please approve our product specifications or transact the approval sheet for product specifications before ordering.

1. Standard Land Pattern Dimensions

-  Land Pattern + Solder Resist
 -  Land Pattern
 -  Solder Resist
 -  Through Hole
- (in mm)

BNX02□

- (1) A double-sided print board (or multilayer board) as shown in the left figure is designed, and please apply a soldering Cu electrode with a product electrode to a "Land Pattern", apply resist to a "Land Pattern + Solder Resist" at Cu electrode.
- (2) This product is designed to meet large current. Please design PCB pattern which is connected to this product not to become too hot by applied large current.
- (3) Please drop CG on a ground electrode on the back layer (the same also in a multilayer case) by the through hole. And a surface to ground electrode layer may also take a large area as much as possible.
- (4) It is recommended to use a double-sided printed circuit board with BNX mounting on one side and the ground pattern on the other in order to maximize filtering performance, multiple feed through holes are required to maximize the BNX's connection to ground.
- (5) The ground pattern should be designed to be as large as possible to achieve maximum filtering performance.

● PCB Warping (for BNX02□)

PCB should be designed so that products are not subjected to the mechanical stress caused by warping the board.

Products should be located in the sideways direction (Length: a-b) to the mechanical stress.

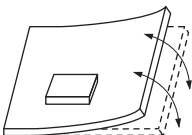

Poor example

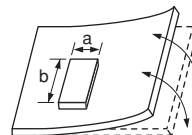

Good example

2. Solder Paste Printing and Adhesive Application

When reflow soldering the block type EMIFIL[®], the printing must be conducted in accordance with the following cream solder printing conditions.

If too much solder is applied, the chip will be prone to damage by mechanical and thermal stress from the PCB and may crack.

Standard land dimensions should be used for resist and copper foil patterns.

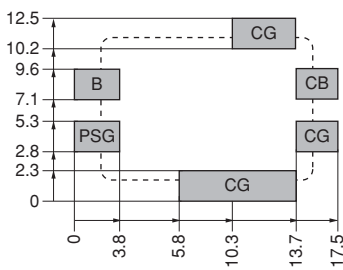
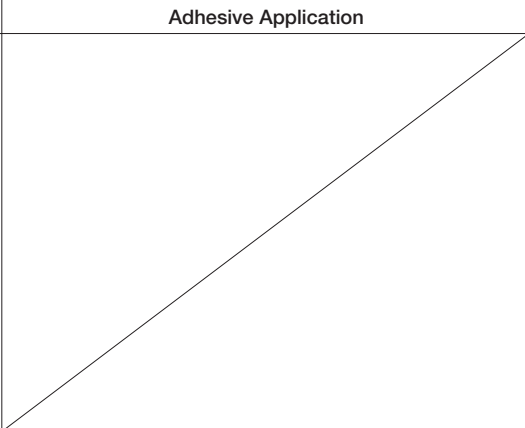
Series	Solder Paste Printing	Adhesive Application
<p>BNX02□</p>	<p>●Guideline of solder paste thickness: 150-200μm</p> <div style="text-align: center;">  </div>	<div style="text-align: center; height: 150px;">  </div>

⚠Note • Please read rating and ⚠CAUTION (for storage, operating, rating, soldering, mounting and handling) in this catalog to prevent smoking and/or burning, etc.
• This catalog has only typical specifications. Therefore, please approve our product specifications or transact the approval sheet for product specifications before ordering.

3. Standard Soldering Conditions

(1) Soldering Methods

Use reflow soldering methods only.
 Use standard soldering conditions when soldering block type EMIFIL® SMD type.
 In cases where several different parts are soldered, each having different soldering conditions, use those conditions requiring the least heat and minimum time.

Solder: Use Sn-3.0Ag-0.5Cu solder. Use of Sn-Zn based solder will deteriorate performance of products.

Flux:

- Use Rosin-based flux.
 In case of using RA type solder, products should be cleaned completely with no residual flux.
- Do not use strong acidic flux (with chlorine content exceeding 0.20wt%)
- Do not use water-soluble flux.

For additional mounting methods, please contact Murata.

(2) Soldering Profile

● Reflow Soldering Profile (Sn-3.0Ag-0.5Cu solder)

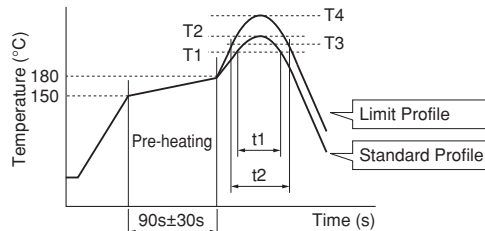

Series	Standard Profile				Limit Profile			
	Heating		Peak Temperature (T2)	Cycle of Reflow	Heating		Peak Temperature (T4)	Cycle of Reflow
	Temp. (T1)	Time. (t1)			Temp. (T3)	Time. (t2)		
BNX02□	220°C min.	30 to 60s	250±3°C	2 times max.	230°C min.	60s max.	260°C/10s	2 times max.

(3) Reworking with Solder Iron

The following conditions must be strictly followed when using a soldering iron.
 Pre-heating: 150°C 60s min.
 Soldering iron power output: 100W max.
 Temperature of soldering iron tip / Soldering time / Times:
 450°C max. / 5s max. / 2 time

Do not allow the tip of the soldering iron to directly contact the chip.
 For additional methods of reworking with a soldering iron, please contact Murata engineering.

4. Cleaning

Do not clean BNX02□ series, or inner humidity protect material will be damaged, results product's insulation resistance getting worse.

△Note • Please read rating and △CAUTION (for storage, operating, rating, soldering, mounting and handling) in this catalog to prevent smoking and/or burning, etc.
 • This catalog has only typical specifications. Therefore, please approve our product specifications or transact the approval sheet for product specifications before ordering.

Minimum Quantity and Dimensions of 24mm Width Embossed Tape

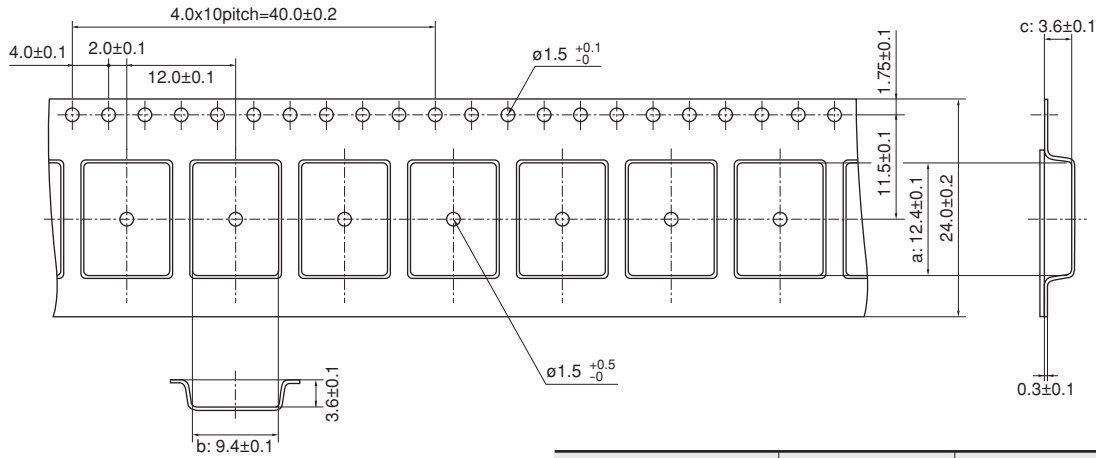

Dimension of the cavity is measured at the bottom side.

Part Number	Dimensions			Minimum Qty. (pcs.)		
	a	b	c	ø180mm reel	ø330mm reel	Bulk
BNX024/025/026/027	12.4	9.4	3.6	400	1500	100

(in mm)

"Minimum Quantity" means the number of units of each delivery or order. The quantity should be an integral multiple of the "Minimum Quantity."

Note • Please read rating and **CAUTION** (for storage, operating, rating, soldering, mounting and handling) in this catalog to prevent smoking and/or burning, etc.
• This catalog has only typical specifications. Therefore, please approve our product specifications or transact the approval sheet for product specifications before ordering.



DS Disc Type EMIFIL®

Part Numbering

(Part Number)

DS	S	1	Z	B3	2A	220	Q55	B
①	②	③	④	⑤	⑥	⑦	⑧	⑨

① Product ID

Product ID	
DS	Three-terminal Capacitor

② Structure

Code	Structure
S	Built-in Ferrite Beads Type

③ Style

Code	Style
1	Expressed by a letter.

④ Category

Code	Category	
Z	For Automotive	Infotainment

⑧ Lead Type/⑨ Packaging

Code	Lead Type	Lead Length* (mm)	Packaging	Series
Q55B	Straight	25.0 min.	Bulk	DSS1
Q91J		20.0±1.0	Paper Reel (ø320mm)	
Q91A			Ammo Pack	

*Lead Distance between Reference and Bottom Planes Except for Bulk.

⑤ Temperature Characteristics

Code	Capacitance Change
B3	±10% (Temperature Range: -25°C to +85°C)

⑥ Rated Voltage

Code	Rated Voltage
1H	50V
2A	100V

⑦ Capacitance

Expressed by three alphanumerics. The unit is in pico-farad (pF). The first and second figures are significant digits, and the third figure expresses the number of zeros that follow the two figures.

SMD Type
Chip Ferrite Bead

SMD Type
Chip EMIFIL®

SMD Type
Chip Common Mode Choke Coil

SMD Type
Block Type EMIFIL®

Lead Type
EMI Suppression Filters

SMD Type
Microchip Transformer (Balun)

△Note • Please read rating and △CAUTION (for storage, operating, rating, soldering, mounting and handling) in this catalog to prevent smoking and/or burning, etc.
• This catalog has only typical specifications. Therefore, please approve our product specifications or transact the approval sheet for product specifications before ordering.



VF EMIGUARD® (EMIFIL® with Varistor Function)

Part Numbering

(Part Number) **VF C 2 H R7 1D 105 K 2 K1 B**
 ① ② ③ ④ ⑤ ⑥ ⑦ ⑧ ⑨ ⑩ ⑪

① Product ID

Product ID	
VF	EMIGUARD® Lead Type

② Structure

Code	Structure
C	Built-in Capacitor

③ Style

Code	Style
2	Size is expressed by a digit

④ Features

Code	Features	
H	For Automotive	Powertrain, Safety

⑤ Temperature Characteristics

Code	Capacitance Change
R7	±15% (Temperature Range: -55°C to +125°C)

⑩ Lead Type/⑪ Packaging

Code	Lead Type	Lead Length*	Packaging	Series
K1B	Inside Crimp	26.0±1.0mm	Bulk	VFC2
M1A			Ammo Pack	
M1J		18.0±1.0mm	Paper Reel (ø320mm)	

*From bottom of the crimp.

⑥ Rated Voltage

Code	Rated Voltage
1D	22V

⑦ Capacitance

Expressed by three alphanumeric. The unit is in pico-farad (pF). The first and second figures are significant digits, and the third figure expresses the number of zeros that follow the two figures.

⑧ Capacitance

Code	Capacitance
K	±10%

⑨ Varistor Voltage

Code	Varistor Voltage
2	27V

△Note • Please read rating and △CAUTION (for storage, operating, rating, soldering, mounting and handling) in this catalog to prevent smoking and/or burning, etc.
 • This catalog has only typical specifications. Therefore, please approve our product specifications or transact the approval sheet for product specifications before ordering.

Chip Ferrite Bead SMD Type
 Chip EMIFIL® SMD Type
 Chip Common Mode Choke Coil SMD Type
 Block Type EMIFIL® SMD Type
 EMI Suppression Filters Lead Type
 Microchip Transformer (Balun) SMD Type

DSS1 Series

3 terminal structure enables excellent high frequency characteristics.

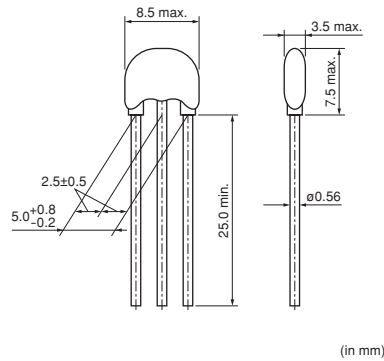
■ Appearance/
Dimensions

■ Packaging

Code	Packaging	Minimum Quantity
B	Packing in Bulk	250
A	Ammo Pack	1500
R	ø320mm Reel	1500



■ Equivalent Circuit

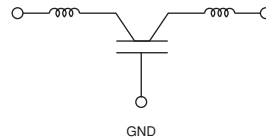

No polarity.

Refer to p.140 for mounting information.

■ Rated Value (□: packaging code)

Part Number		Capacitance	Rated Current	Rated Voltage	Operating Temperature Range
For Infotainment	For Powertrain/Safety				
DSS1ZB32A220Q55B□	—	22pF ±10%	6A	100Vdc	-40°C~+85°C
DSS1ZB32A220Q91A□	—	22pF ±10%	6A	100Vdc	-40°C~+85°C
DSS1ZB32A220Q91J□	—	22pF ±10%	6A	100Vdc	-40°C~+85°C
DSS1ZB32A330Q55B□	—	33pF ±10%	6A	100Vdc	-40°C~+85°C
DSS1ZB32A330Q91A□	—	33pF ±10%	6A	100Vdc	-40°C~+85°C
DSS1ZB32A330Q91J□	—	33pF ±10%	6A	100Vdc	-40°C~+85°C
DSS1ZB32A470Q55B□	—	47pF ±10%	6A	100Vdc	-40°C~+85°C
DSS1ZB32A470Q91A□	—	47pF ±10%	6A	100Vdc	-40°C~+85°C
DSS1ZB32A470Q91J□	—	47pF ±10%	6A	100Vdc	-40°C~+85°C
DSS1ZB32A680Q55B□	—	68pF ±10%	6A	100Vdc	-40°C~+85°C
DSS1ZB32A680Q91A□	—	68pF ±10%	6A	100Vdc	-40°C~+85°C
DSS1ZB32A680Q91J□	—	68pF ±10%	6A	100Vdc	-40°C~+85°C
DSS1ZB32A101Q55B□	—	100pF ±10%	6A	100Vdc	-40°C~+85°C
DSS1ZB32A101Q91A□	—	100pF ±10%	6A	100Vdc	-40°C~+85°C
DSS1ZB32A101Q91J□	—	100pF ±10%	6A	100Vdc	-40°C~+85°C
DSS1ZB32A121Q55B□	—	120pF ±10%	6A	100Vdc	-40°C~+85°C
DSS1ZB32A121Q91A□	—	120pF ±10%	6A	100Vdc	-40°C~+85°C
DSS1ZB32A121Q91J□	—	120pF ±10%	6A	100Vdc	-40°C~+85°C
DSS1ZB32A151Q55B□	—	150pF ±10%	6A	100Vdc	-40°C~+85°C
DSS1ZB32A151Q91A□	—	150pF ±10%	6A	100Vdc	-40°C~+85°C
DSS1ZB32A151Q91J□	—	150pF ±10%	6A	100Vdc	-40°C~+85°C
DSS1ZB32A221Q55B□	—	220pF ±10%	6A	100Vdc	-40°C~+85°C
DSS1ZB32A221Q91A□	—	220pF ±10%	6A	100Vdc	-40°C~+85°C
DSS1ZB32A221Q91J□	—	220pF ±10%	6A	100Vdc	-40°C~+85°C
DSS1ZB32A271Q55B□	—	270pF ±10%	6A	100Vdc	-40°C~+85°C
DSS1ZB32A271Q91A□	—	270pF ±10%	6A	100Vdc	-40°C~+85°C
DSS1ZB32A271Q91J□	—	270pF ±10%	6A	100Vdc	-40°C~+85°C
DSS1ZB32A331Q55B□	—	330pF ±10%	6A	100Vdc	-40°C~+85°C
DSS1ZB32A331Q91A□	—	330pF ±10%	6A	100Vdc	-40°C~+85°C
DSS1ZB32A331Q91J□	—	330pF ±10%	6A	100Vdc	-40°C~+85°C
DSS1ZB32A471Q55B□	—	470pF ±10%	6A	100Vdc	-40°C~+85°C
DSS1ZB32A471Q91A□	—	470pF ±10%	6A	100Vdc	-40°C~+85°C
DSS1ZB32A471Q91J□	—	470pF ±10%	6A	100Vdc	-40°C~+85°C

Number of Circuit: 1

Continued on the following page.

△Note • Please read rating and ⚠CAUTION (for storage, operating, rating, soldering, mounting and handling) in this catalog to prevent smoking and/or burning, etc.
• This catalog has only typical specifications. Therefore, please approve our product specifications or transact the approval sheet for product specifications before ordering.

Part Number		Capacitance	Rated Current	Rated Voltage	Operating Temperature Range
For Infotainment	For Powertrain/Safety				
DSS1ZB32A681Q55B□	—	680pF ±10%	6A	100Vdc	-40°C~+85°C
DSS1ZB32A681Q91A□	—	680pF ±10%	6A	100Vdc	-40°C~+85°C
DSS1ZB32A681Q91J□	—	680pF ±10%	6A	100Vdc	-40°C~+85°C
DSS1ZB32A102Q55B□	—	1000pF ±10%	6A	100Vdc	-40°C~+85°C
DSS1ZB32A102Q91A□	—	1000pF ±10%	6A	100Vdc	-40°C~+85°C
DSS1ZB32A102Q91J□	—	1000pF ±10%	6A	100Vdc	-40°C~+85°C
DSS1ZB32A152Q55B□	—	1500pF ±10%	6A	100Vdc	-40°C~+85°C
DSS1ZB32A152Q91A□	—	1500pF ±10%	6A	100Vdc	-40°C~+85°C
DSS1ZB32A152Q91J□	—	1500pF ±10%	6A	100Vdc	-40°C~+85°C
DSS1ZB32A222Q55B□	—	2200pF ±10%	6A	100Vdc	-40°C~+85°C
DSS1ZB32A222Q91A□	—	2200pF ±10%	6A	100Vdc	-40°C~+85°C
DSS1ZB32A222Q91J□	—	2200pF ±10%	6A	100Vdc	-40°C~+85°C
DSS1ZB32A332Q55B□	—	3300pF ±10%	6A	100Vdc	-40°C~+85°C
DSS1ZB32A332Q91A□	—	3300pF ±10%	6A	100Vdc	-40°C~+85°C
DSS1ZB32A332Q91J□	—	3300pF ±10%	6A	100Vdc	-40°C~+85°C
DSS1ZB32A472Q55B□	—	4700pF ±10%	6A	100Vdc	-40°C~+85°C
DSS1ZB32A472Q91A□	—	4700pF ±10%	6A	100Vdc	-40°C~+85°C
DSS1ZB32A472Q91J□	—	4700pF ±10%	6A	100Vdc	-40°C~+85°C
DSS1ZB32A682Q55B□	—	6800pF ±10%	6A	100Vdc	-40°C~+85°C
DSS1ZB32A682Q91A□	—	6800pF ±10%	6A	100Vdc	-40°C~+85°C
DSS1ZB32A682Q91J□	—	6800pF ±10%	6A	100Vdc	-40°C~+85°C
DSS1ZB32A103Q55B□	—	10000pF ±10%	6A	100Vdc	-40°C~+85°C
DSS1ZB32A103Q91A□	—	10000pF ±10%	6A	100Vdc	-40°C~+85°C
DSS1ZB32A103Q91J□	—	10000pF ±10%	6A	100Vdc	-40°C~+85°C
DSS1ZB32A153Q55B□	—	15000pF ±10%	6A	100Vdc	-40°C~+85°C
DSS1ZB32A153Q91A□	—	15000pF ±10%	6A	100Vdc	-40°C~+85°C
DSS1ZB32A153Q91J□	—	15000pF ±10%	6A	100Vdc	-40°C~+85°C
DSS1ZB32A223Q55B□	—	22000pF ±10%	6A	100Vdc	-40°C~+85°C
DSS1ZB32A223Q91A□	—	22000pF ±10%	6A	100Vdc	-40°C~+85°C
DSS1ZB32A223Q91J□	—	22000pF ±10%	6A	100Vdc	-40°C~+85°C
DSS1ZB31H333Q55B□	—	33000pF ±10%	6A	50Vdc	-40°C~+85°C
DSS1ZB31H333Q91A□	—	33000pF ±10%	6A	50Vdc	-40°C~+85°C
DSS1ZB31H333Q91J□	—	33000pF ±10%	6A	50Vdc	-40°C~+85°C
DSS1ZB31H473Q55B□	—	47000pF ±10%	6A	50Vdc	-40°C~+85°C
DSS1ZB31H473Q91A□	—	47000pF ±10%	6A	50Vdc	-40°C~+85°C
DSS1ZB31H473Q91J□	—	47000pF ±10%	6A	50Vdc	-40°C~+85°C
DSS1ZB31H104Q55B□	—	100000pF ±10%	6A	50Vdc	-40°C~+85°C
DSS1ZB31H104Q91A□	—	100000pF ±10%	6A	50Vdc	-40°C~+85°C
DSS1ZB31H104Q91J□	—	100000pF ±10%	6A	50Vdc	-40°C~+85°C

Number of Circuit: 1

■ Insertion Loss Characteristics (Main Items)

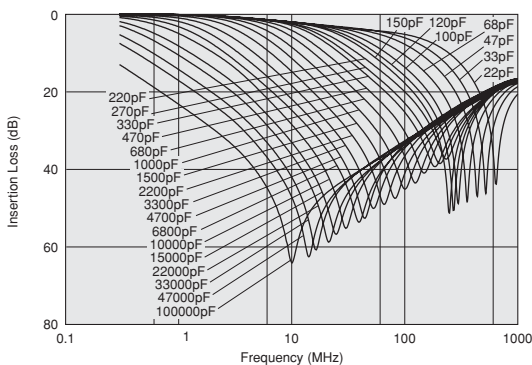

△Note • Please read rating and △CAUTION (for storage, operating, rating, soldering, mounting and handling) in this catalog to prevent smoking and/or burning, etc.
 • This catalog has only typical specifications. Therefore, please approve our product specifications or transact the approval sheet for product specifications before ordering.

Chip Ferrite Bead SMD Type
 Chip EMIFIL® SMD Type
 Chip Common Mode Choke Coil SMD Type
 Block Type EMIFIL® SMD Type
 EMIFIL® Lead Type
 Microchip Transformer (Balun) SMD Type

VFC2 Series

Large capacitance and high surge current of 200A.

■ Appearance/Dimensions

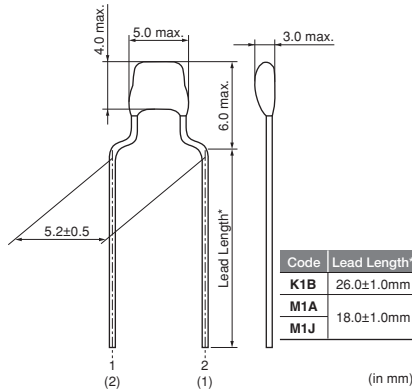

■ Packaging

Code	Packaging	Minimum Quantity
B	Packing in Bulk	500
A	Ammo Pack	2000
J	ø320mm Paper Reel	2000



■ Equivalent Circuit

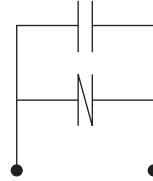

Refer to p.140 for mounting information.

■ Rated Value (□: packaging code)

Part Number		Varistor Voltage	Capacitance	Temperature Characteristics	Rated Voltage	Insulation Resistance (min.)
For Infotainment	For Powertrain/Safety					
—	VFC2HR71D105K2M1□	27Vdc +5/-3V	1.0μF ±10%	R7 (±15%)	22Vdc	1MΩ

Operating Temperature Range: -55°C~+125°C

SMD Type
Chip Ferrite Bead

SMD Type
Chip EMIFIL®

SMD Type
Chip Common Mode Choke Coil

SMD Type
Block Type EMIFIL®

Lead Type
EMIGUARD® (EMIFIL® with Varistor Function)

SMD Type
Microchip Transformer (Balun)

⚠Note • Please read rating and ⚠CAUTION (for storage, operating, rating, soldering, mounting and handling) in this catalog to prevent smoking and/or burning, etc.
• This catalog has only typical specifications. Therefore, please approve our product specifications or transact the approval sheet for product specifications before ordering.

BNX012 Series

Wide noise suppression frequency range from 100kHz to several GHz is available. (Lead type)

Appearance/Dimensions

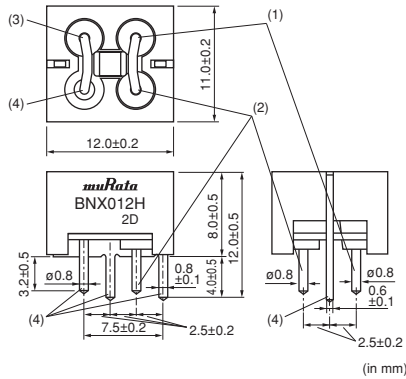

Packaging

Code	Packaging	Minimum Quantity
-	Box	150



Equivalent Circuit

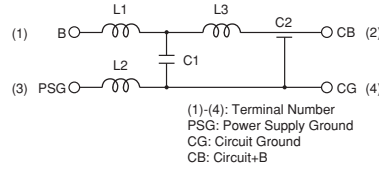

Refer to pages from p.141 to p.142 for mounting information.

Rated Value (□: packaging code)

Part Number		Rated Voltage	Withstand Voltage	Rated Current	Insulation Resistance (min.)	Insertion Loss
For Infotainment	For Powertrain/Safety					
—	BNX012H0	50Vdc	125Vdc	15A	500MΩ	1MHz to 1GHz:40dB min. (Line impedance=50Ω)

Operating Temperature Range: -55°C~+125°C
 In operating temperatures exceeding +85°C, derating of current is necessary.

Insertion Loss Characteristics (Main Items)

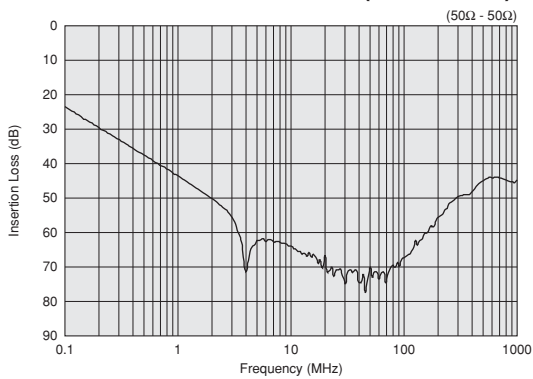

Continued on the following page.

△Note • Please read rating and △CAUTION (for storage, operating, rating, soldering, mounting and handling) in this catalog to prevent smoking and/or burning, etc.
 • This catalog has only typical specifications. Therefore, please approve our product specifications or transact the approval sheet for product specifications before ordering.

■ Derating of Rated current

● Rating

In operating temperatures exceeding +85°C, derating of current is necessary for BNX012H series. Please apply the derating curve shown in chart according to the operating temperature.

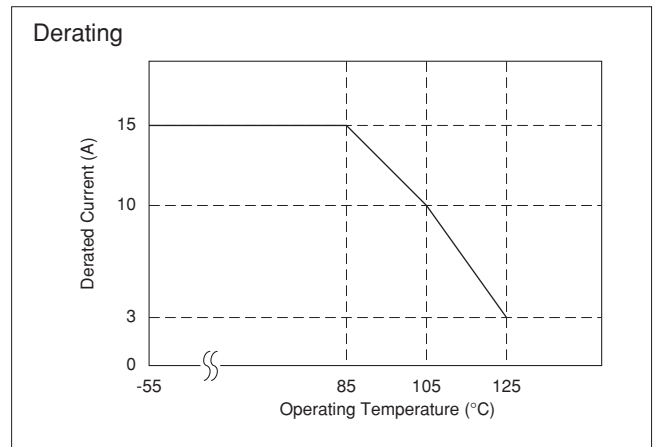

● Connecting ± Power Line

In case of using ± power line, please connect to each terminal as shown.

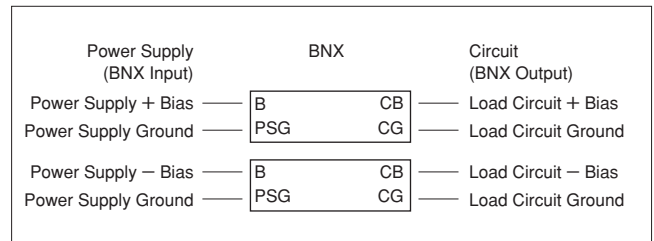

⚠Note • Please read rating and ⚠CAUTION (for storage, operating, rating, soldering, mounting and handling) in this catalog to prevent smoking and/or burning, etc.
• This catalog has only typical specifications. Therefore, please approve our product specifications or transact the approval sheet for product specifications before ordering.

⚠ Caution

● Rating

1. Do not use products beyond the rated current and rated voltage as this may create excessive heat and deteriorate the insulation resistance.
2. Products should not be applied for the absorption of surge which have large energy (ex. Included lighting surge, switching surges) because it is designed for the absorption of electrostatic surges, or it results cracks in ceramics which may lead to smoking / firing.

● Soldering and Mounting

1. Mounting holes should be designed as specified in these specifications. Other designs than those shown in these specifications may cause cracks in ceramics that may lead to smoking or firing.
2. Take care not to apply any mechanical stress to product body at the lead terminal bending process for product angle adjustment after insertion.

Notice

● Storage and Operating Conditions

<Operating Environment>

1. Do not use products in a chemical atmosphere such as chlorine gas, acid or sulfide gas.
2. Do not use products near water, oil or organic solvents. Avoid environments where dust or dirt may adhere to the product.
3. Do not adhere any resin to products, coat nor mold products with any resin (including adhesive) to prevent mechanical and chemical stress on products.

<Storage and Handling Requirements>

1. Storage Period
Use the products within 12 months after delivery.
Solderability should be checked if this period is exceeded.
2. Storage Conditions
 - (1) Storage temperature: -10 to 40 degrees C
Relative humidity: 15 to 85%
Avoid sudden changes in temperature and humidity.
 - (2) Do not store products in a chemical atmosphere such as chlorine gas, acid or sulfide gas.

<Using EMIGUARD® effectively>

1. Products should be used at rated voltage or less and rated current or less.

● Soldering and Mounting

1. Washing
Failure and degradation of a product are caused by the washing method. When you wash in conditions that are not in the mounting information, please contact Murata engineering.
2. Soldering
Reliability decreases with improper soldering methods. Please solder by the standard soldering conditions shown in the mounting information.
3. Other
Noise suppression levels resulting from Murata's EMI suppression filters EMIFIL® may vary, depending on the circuits and ICs used, type of noise, mounting pattern, lead wire length, mounting location, and other operating conditions. Be sure to check and confirm in advance the noise suppression effect of each filter, in actual circuits, etc. before applying the filter in a commercial-purpose equipment design.

⚠ Caution**● Rating**

Do not use products beyond the rated current and rated voltage as this may create excessive heat and deteriorate the insulation resistance.

Notice**● Storage and Operating Conditions**

<Operating Environment>

1. Do not use products in a chemical atmosphere such as chlorine gas, acid or sulfide gas.
2. Do not use products near water, oil or organic solvents.

<Storage and Handling Requirements>

1. Storage Period
BNX Series should be used within 12 months.
Solderability should be checked if this period is exceeded.
2. Storage Conditions
 - (1) Storage temperature: -10 to +40°C
Relative humidity: 15 to 85%
Avoid sudden changes in temperature and humidity.
 - (2) Do not store products in a chemical atmosphere such as chlorine gas, acid or sulfide gas.

● Notice (Soldering and Mounting)

1. Cleaning
Failure and degradation of a product are caused by the cleaning method. When you clean in conditions that are not in mounting information, please contact Murata engineering.
2. Soldering
Reliability decreases with improper soldering methods. Please solder by the standard soldering conditions shown in mounting information.
3. Other
Noise suppression levels resulting from Murata's EMI suppression filters "EMIFIL" may vary, depending on the circuits and ICs used, type of noise, mounting pattern, lead wire length, mounting location, and other operating conditions. Be sure to check and confirm in advance the noise suppression effect of each filter, in actual circuits, etc. before applying the filter in a commercial-purpose equipment design.

● Notice (Appearance)

Although some part of the product surface seems to be white in some cases, do not care because it is the result of waxing process for humidity resistance improvement. This wax does not make bad affection to mechanical or electrical performance, reliability of the product.

SMD Type
Chip Ferrite BeadSMD Type
Chip EMIFIL®SMD Type
Chip Common Mode Choke CoilSMD Type
Block Type EMIFIL®Lead Type
⚠ Caution/NoticeSMD Type
Microchip Transformer (Balun)

⚠ Note • Please read rating and ⚠ CAUTION (for storage, operating, rating, soldering, mounting and handling) in this catalog to prevent smoking and/or burning, etc.
• This catalog has only typical specifications. Therefore, please approve our product specifications or transact the approval sheet for product specifications before ordering.

1. Mounting Hole

Mounting holes should be designed as specified below.

Part Number	Bulk Type (in mm)	Taping Type (in mm)
DSS1		
VFC2H		

2. Soldering

- (1) Use Sn-3.0Ag-0.5Cu solder.
- (2) Use Rosin-based flux. Do not use strong acidic flux with halide content exceeding 0.2wt% (chlorine conversion value).
- (3) Products and the leads should not be subjected to any mechanical stress during the soldering process, or while subjected to the equivalent high temperatures.
- (4) Standard flow soldering profile.

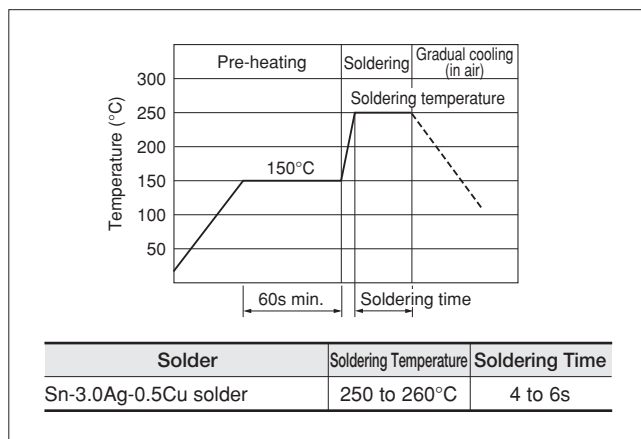

3. Cleaning Conditions

Clean other parts in the following conditions.

- (1) Cleaning temperature should be limited to 60°C max. (40°C max for alcohol type cleaner).
- (2) Ultrasonic cleaning should comply with the following conditions, avoiding the resonance phenomenon at the mounted products and PCB.
Power: 20 W / ℓ max. Frequency: 28 to 40kHz
Time: 5 min. max.
- (3) Cleaner
 - (a) Alcohol type cleaner
Isopropyl alcohol (IPA)
 - (b) Aqueous agent (PLT series cannot be cleaned)
PINE ALPHA ST-100S
- (4) There should be no residual flux or residual cleaner left after cleaning.
In the case of using aqueous agent, products should be dried completely after rinsing with de-ionized water in order to remove the cleaner.
- (5) The surface of products may become dirty after cleaning, but there is no deterioration on mechanical, electrical characteristics and reliability.
- (6) Other cleaning: Please contact us.

⚠Note • Please read rating and ⚠CAUTION (for storage, operating, rating, soldering, mounting and handling) in this catalog to prevent smoking and/or burning, etc.
• This catalog has only typical specifications. Therefore, please approve our product specifications or transact the approval sheet for product specifications before ordering.

1. Mounting Hole

■ Mounting holes should be designed as specified below.

BNX01□

Component Side

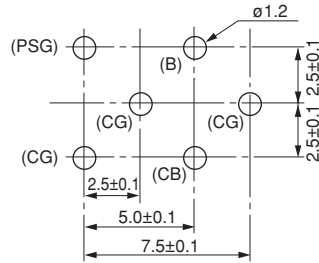

Terminal Layout (Bottom figure)

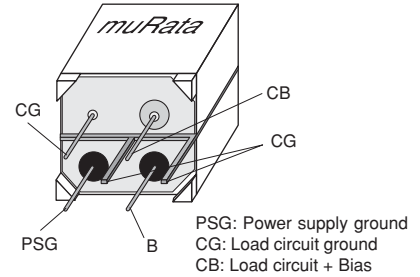

2. Using the Block Type EMIFIL® (Lead Type) Effectively

(1) How to use effectively

This product effectively prevents undesired radiation and external noise from going out / entering the circuit by grounding the high frequency components which cause noise problems. Therefore, grounding conditions may affect the performance of the filter and attention should be paid to the following for effective use.

- Design maximized grounding area in the P.C. board, and grounding pattern for all the grounding terminals of the product to be connected. (Please follow the specified recommendations.)
- Minimize the distance between ground of the P.C. board and the ground plate of the product. (Recommend using the through hole connection between grounding area both of component side and bottom side.)
- Insert the terminals into the holes on P.C. board completely.
- Don't connect PSG terminal with CG terminal directly. (See the item 1. Terminal Layout)

(2) Self-heating

Though this product has a large rated current, localized self-heating may be caused depending on soldering conditions. To avoid this, attention should be paid to the following:

- Use P.C. board with our recommendation on hole diameter / land pattern dimensions, mentioned in the right hand drawing, especially for 4 terminals which pass current.
- Solder the terminals to the P.C. board with soldercover area at least 90%. Otherwise, excess self-heating at connection between terminals and P.C. board may lead to smoke and / or fire of the product even when operating at rated current.
- After installing this product in your product, please make sure the self-heating is within the rated current recommended.

P. C. Board Patterns

Use a bilateral P.C. board. Insert the BNX into the P.C. board until the root of the terminal is secured, then solder.

(1) Component Side View

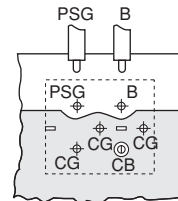

(2) Bottom View

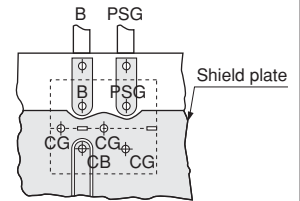

Legend: Copper foil pattern

Recommended Land Pattern

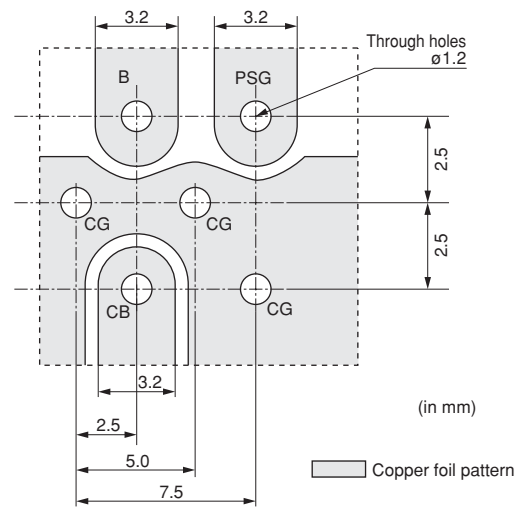

⚠Note • Please read rating and ⚠CAUTION (for storage, operating, rating, soldering, mounting and handling) in this catalog to prevent smoking and/or burning, etc.
• This catalog has only typical specifications. Therefore, please approve our product specifications or transact the approval sheet for product specifications before ordering.

3. Soldering

- (1) Use Sn-3.0Ag-0.5Cu solder.
- (2) Use Rosin-based flux. Do not use strong acidic flux with halide content exceeding 0.2wt% (chlorine conversion value).
- (3) Products and the leads should not be subjected to any mechanical stress during the soldering process, or while subjected to the equivalent high temperatures.
- (4) Standard flow soldering profile

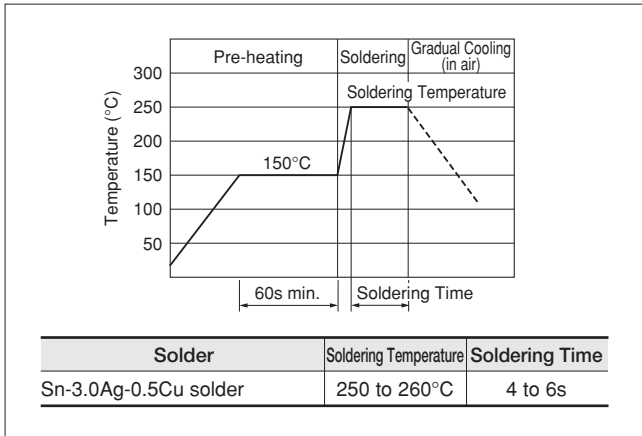

4. Cleaning

Clean the block Type EMIFIL®(Lead Type) in the following conditions.

- (1) Cleaning temperature should be limited to 60°C max. (40°C max for alcohol type cleaner).
- (2) Ultrasonic cleaning should comply with the following conditions, avoiding the resonance phenomenon at the mounted products and P.C.B.
 Power: 20W/liter max.
 Frequency: 28 to 40kHz
 Time: 5 min. max.
- (3) Cleaner
 - (a) Alcohol type cleaner
Isopropyl alcohol (IPA)
 - (b) Aqueous agent
Pine Alpha ST-100S
- (4) There should be no residual flux or residual cleaner left after cleaning.
 In the case of using aqueous agent, products should be dried completely after rinsing with de-ionized water in order to remove the cleaner.
- (5) The surface of products may become dirty after cleaning, but there is no deterioration on mechanical, electrical characteristics and reliability.
- (6) Other cleaning: Please contact us.

⚠Note • Please read rating and ⚠CAUTION (for storage, operating, rating, soldering, mounting and handling) in this catalog to prevent smoking and/or burning, etc.
 • This catalog has only typical specifications. Therefore, please approve our product specifications or transact the approval sheet for product specifications before ordering.

Chip Ferrite Bead SMD Type
 Chip EMIFIL® SMD Type
 Chip Common Mode Choke Coil SMD Type
 Block Type EMIFIL® SMD Type
 Soldering and Mounting Lead Type
 Microchip Transformer (Balun) SMD Type

Minimum Quantity

Part Number	Minimum Order Quantity (order in sets only) (pcs.)		
	Ammo Pack	ø320mm Paper Reel	Bulk (Bag)
VFC2H Series	2000	2000	500
DSS1 Series	1500	1500	250

Lead Type Code

Lead Type Code	Lead Length (H)
Straight Type	
Q55B	25.0mm min.
Q91A	20.0±1.0mm
Q91J	

Lead Type Code	Lead Length (from bottom of the crimp)
Inside Crimp	
K1B	26.0±1.0mm
M1A	18.0±1.0mm
M1J	

Taping Dimensions

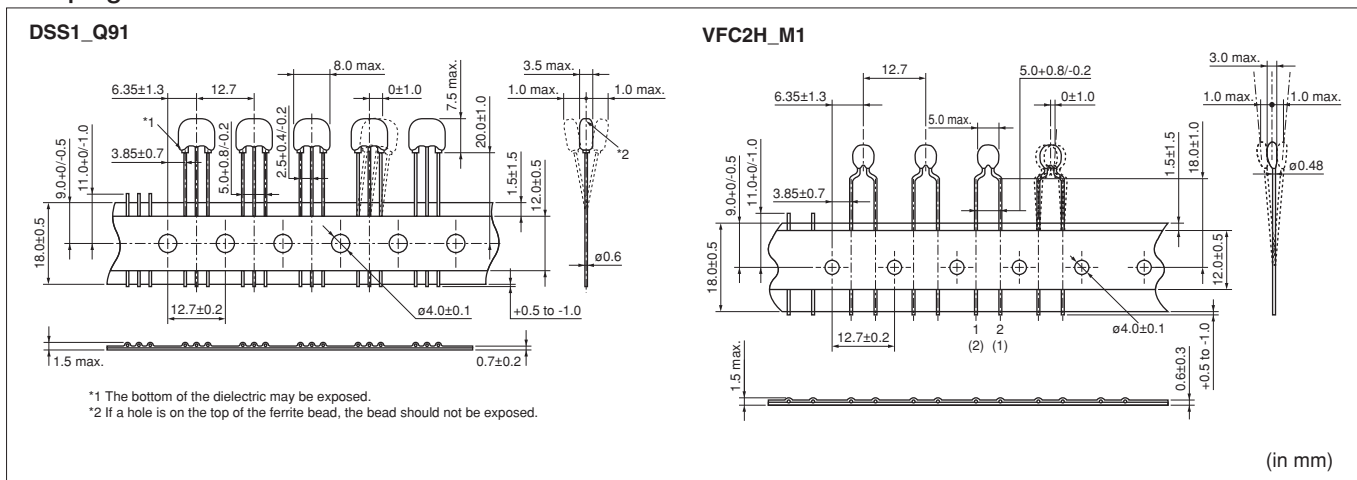

Note • Please read rating and CAUTION (for storage, operating, rating, soldering, mounting and handling) in this catalog to prevent smoking and/or burning, etc.
 • This catalog has only typical specifications. Therefore, please approve our product specifications or transact the approval sheet for product specifications before ordering.



DX



Micro Chip Transformer (Balun)

Part Numbering

(Part Number)

DX	W	21	B	Z	75	11	T	L
①	②	③	④	⑤	⑥	⑦	⑧	⑨

① Product ID

Product ID	
DX	Micro Chip Transformer

② Structure

Code	Structure
W	Winding Type

③ Dimensions (L×W)

Code	Dimensions (L×W)	EIA
21	2.0×1.2mm	0805

④ Type of Transformer

Code	Type of Transformer
B	Balun

⑤ Category

Code	Category	
Z	For Automotive	Infotainment

⑥ Port Impedance

Code	Port Impedance
75	75Ω

⑦ Characteristics

Code	Impedance Ratio
11	one to one

⑧ Rough Frequency Range

Code	Rough Frequency Range
T	50MHz to 870MHz
S	950MHz to 2150MHz

⑨ Packaging

Code	Packaging
K	Embossed Taping (ø330mm Reel)
L	Embossed Taping (ø180mm Reel)
B	Bulk

⚠Note • Please read rating and ⚠CAUTION (for storage, operating, rating, soldering, mounting and handling) in this catalog to prevent smoking and/or burning, etc.
 • This catalog has only typical specifications. Therefore, please approve our product specifications or transact the approval sheet for product specifications before ordering.

Chip Ferrite Bead SMD Type
 Chip EMIFIL® SMD Type
 Chip Common Mode Choke Coil SMD Type
 Block Type EMIFIL® SMD Type
 EMI Suppression Filters Lead Type
 Microchip Transformer (Balun) SMD Type

DXW21B Series 0805/2012 (inch/mm)

0805 size, wire-wound type. (Balun)

Appearance/Dimensions

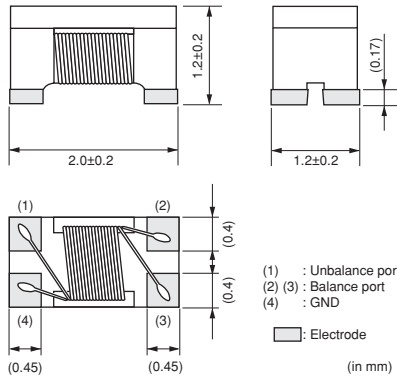

Packaging

Code	Packaging	Minimum Quantity
L	ø180mm Embossed Taping	2000
K	ø330mm Embossed Taping	10000
B	Packing in Bulk	500



Equivalent Circuit

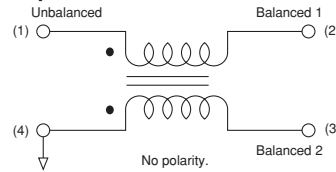

Refer to pages from p.147 to p.148 for mounting information.

Rated Value (□: packaging code)

Part Number		Frequency Range	Port Impedance	Insertion Loss at Freq. Range (max.)	CMRR at Freq. Range (min.)	Rated Power
For Infotainment	For Powertrain/Safety					
DXW21BZ7511S□	—	1 to 1.5GHz	75Ω - 75Ω	1.4dB	20dB	27dBm
DXW21BZ7511T□	—	50 to 870MHz	75Ω - 75Ω	1.0dB	20dB	27dBm

Operating Temperature Range: -40°C~+85°C Only for reflow soldering.

Insertion Loss Characteristics

DXW21BZ7511S

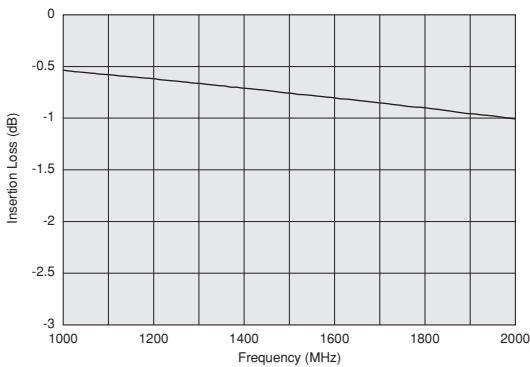

CMRR Characteristics

DXW21BZ7511S

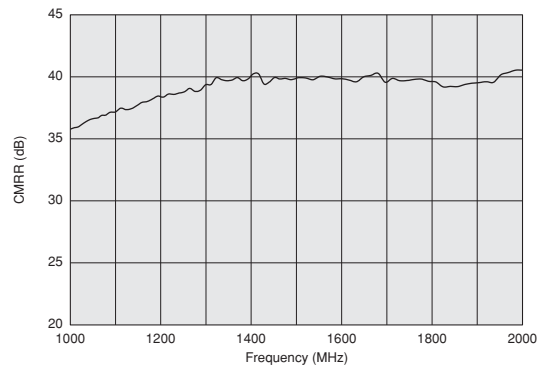

Insertion Loss Characteristics

DXW21BZ7511T

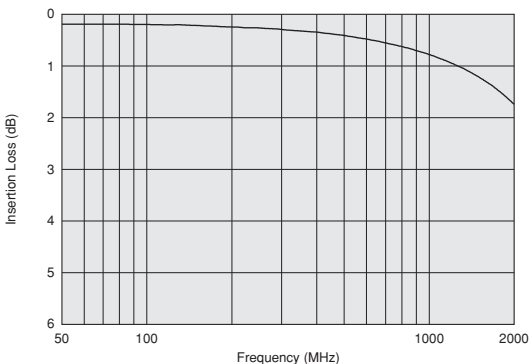

CMRR Characteristics

DXW21BZ7511T

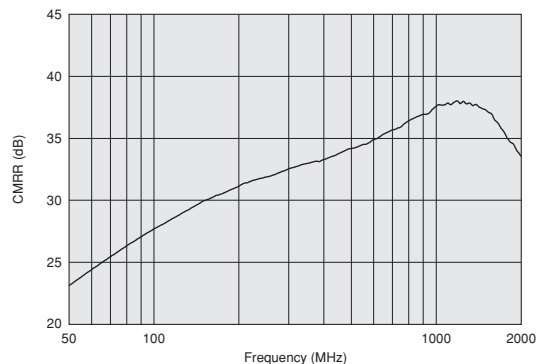

△Note • Please read rating and △CAUTION (for storage, operating, rating, soldering, mounting and handling) in this catalog to prevent smoking and/or burning, etc.
• This catalog has only typical specifications. Therefore, please approve our product specifications or transact the approval sheet for product specifications before ordering.

SMD Type Chip Ferrite Bead
SMD Type Chip EMIFIL®
SMD Type Chip Common Mode Choke Coil
SMD Type Block Type EMIFIL®
Lead Type EMI Suppression Filters
SMD Type Microchip Transformer (Balun)

⚠ Caution

● Rating

Do not use products beyond the rated current and rated voltage as this may create excessive heat and deteriorate the insulation resistance.

● Soldering and Mounting

1. Self-heating

Please provide special attention when mounting chip Micro Chip Transformer (DXW) series in close proximity to other products that radiate heat.

The heat generated by other products may deteriorate the insulation resistance and cause excessive heat in this component.

2. Mounting Direction

Mount Micro Chip Transformer in right direction.

Wrong direction, which is 90 degree rotated from right direction, the characteristics does not come out as Micro Chip Transformer or causes not only open or short circuit but also flames or other serious trouble.

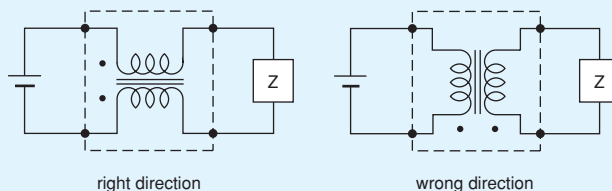

● Storage and Operating Conditions

<Operating Environment>

Do not use products in a chemical atmosphere such as chlorine gas, acid or sulfide gas.

<Storage and Handling Requirements>

1. Storage Period

DXW series should be used within 12 months.

Solderability should be checked if this period is exceeded.

2. Storage Conditions

(1) Storage temperature: -10 to +40 degree C

Relative humidity: 15 to 85%

Avoid sudden changes in temperature and humidity.

(2) Do not store products in a chemical atmosphere such as chlorine gas, acid or sulfide gas.

● Handling

1. Resin Coating

The impedance value may change due to high cure-stress of resin to be used for coating/molding products. An open circuit issue may occur by mechanical stress caused by the resin, amount/cured shape of resin, or operating condition etc. Some resin contains some impurities or chloride possible to generate chlorine by hydrolysis under some operating condition may cause corrosion of wire of coil, leading to open circuit.

So, please pay your careful attention in selecting resin in case of coating/molding the products with the resin. Prior to use the coating resin, please make sure no reliability issue is observed by evaluating products mounted on your board.

2. Handling of a Substrate

After mounting products on a substrate, do not apply any stress to the product caused by bending or twisting to the substrate when cropping the substrate, inserting and removing a connector from the substrate or tightening screw to the substrate.

Excessive mechanical stress may cause cracking in the Product.

Bending

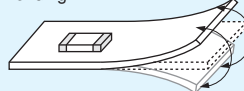

Twisting

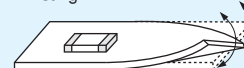

Notice

1. Standard Land Pattern Dimensions

Land Pattern + Solder Resist
 Land Pattern
 Solder Resist

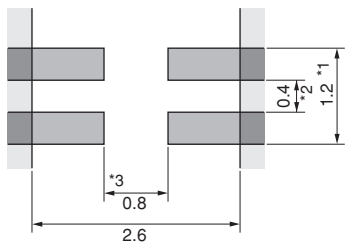
Series	Standard Land Pattern Dimensions	
DXW21	<p>● Reflow Soldering DXW21</p> 	<p>* 1 : If the pattern is made with wider than 1.2mm (DXW21) it may result in components turning around, because melting speed is different. In the worst case, short circuit between lines may occur.</p> <p>* 2 : If the pattern is made with less than 0.4mm, in the worst case, short circuit between lines may occur due to spread of soldering paste or mount placing accuracy.</p> <p>* 3 : If the pattern is made with wider than 0.8mm (DXW21), the bending strength will be reduced.</p> <p>Do not use gild pattern; excess soldering heat may dissolve metal of a copper wire.</p>

2. Solder Paste Printing and Adhesive Application

When reflow soldering the Micro Chip Transformer, the printing must be conducted in accordance with the following cream solder printing conditions.

If too much solder is applied, the chip will be prone to damage by mechanical and thermal stress from the PCB

and may crack. In contrast, if too little solder is applied, there is the potential that the termination strength will be insufficient, creating the potential for detachment.

Standard land dimensions should be used for resist and copper foil patterns.

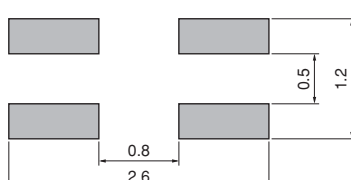
Series	Solder Paste Printing	
DXW21	<p>● Coat the solder paste a thickness: 100-150μm</p>	

3. Standard Soldering Conditions

(1) Soldering Methods

Use reflow soldering methods only.

Use standard soldering conditions when soldering Micro Chip Transformer.

In cases where several different parts are soldered, each having different soldering conditions, use those conditions requiring the least heat and minimum time.

Solder: Use Sn-3.0Ag-0.5Cu solder.

Flux:

- Use Rosin-based flux, (with converting chlorine content 0.06 to 0.1(wt)%), but not highly acidic flux (with Halogen content exceeding 0.2(wt)% conversion to chlorine).
- Do not use water-soluble flux.

Continued on the following page. 

[△]Note • Please read rating and [△]CAUTION (for storage, operating, rating, soldering, mounting and handling) in this catalog to prevent smoking and/or burning, etc.
 • This catalog has only typical specifications. Therefore, please approve our product specifications or transact the approval sheet for product specifications before ordering.

(2) Soldering profile

● Reflow Soldering profile
(Sn-3.0Ag-0.5Cu)

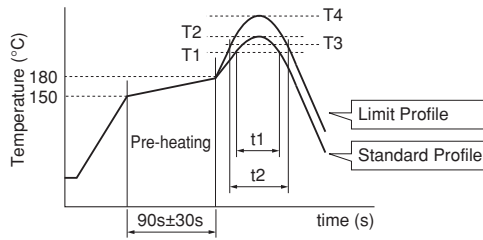

Series	Standard Profile				Limit Profile			
	Heating		Peak temperature (T2)	Cycle of reflow	Heating		Peak temperature (T4)	Cycle of reflow
	Temp. (T1)	Time. (t1)			Temp. (T3)	Time. (t2)		
DXW	220°C min.	30 to 60s	245±3°C	2 times max.	230°C min.	60s max.	260°C/10s	2 times max.

(3) Reworking with Solder Iron

The following conditions must be strictly followed when using a soldering iron.

Pre-heating : 150°C 60s min.

Soldering iron power output : 30W max.

Temperature of soldering iron tip / Soldering time :
280°C max./10s max. or
350°C max./3s max.

For additional methods of reworking with a soldering iron, please contact Murata engineering.

4. Cleaning

Do not clean.

⚠Note • Please read rating and ⚠CAUTION (for storage, operating, rating, soldering, mounting and handling) in this catalog to prevent smoking and/or burning, etc.
• This catalog has only typical specifications. Therefore, please approve our product specifications or transact the approval sheet for product specifications before ordering.

Chip Ferrite Bead
SMD Type

Chip EMIFIL®
SMD Type

Chip Common Mode Choke Coil
SMD Type

Block Type EMIFIL®
SMD Type

EMI Suppression Filters
Lead Type

Soldering and Mounting
Microchip Transformer (Balun)

■ Minimum Quantity and Dimensions of 8mm Width Embossed Tape

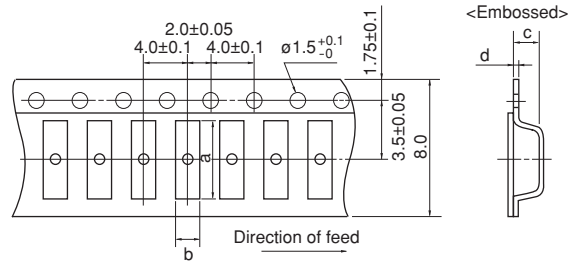

Dimension of the cavity is measured at the bottom side.

Part Number	Dimensions				Minimum Qty. (pcs.)		
					ø180mm reel	ø330mm reel	Bulk
	a	b	c	d	Embossed Tape	Embossed Tape	
DXW21B	2.25	1.45	1.40	0.30	2000	10000	500

(in mm)

SMD Type
Chip Ferrite Bead

SMD Type
Chip EMIFIL®

SMD Type
Chip Common Mode Choke Coil

SMD Type
Block Type EMIFIL®

Lead Type
EMI Suppression Filters

Microchip Transformer (Balun)
Packaging

⚠Note • Please read rating and ⚠CAUTION (for storage, operating, rating, soldering, mounting and handling) in this catalog to prevent smoking and/or burning, etc.
• This catalog has only typical specifications. Therefore, please approve our product specifications or transact the approval sheet for product specifications before ordering.

Memo







Contents

Classification and Structure of Chip Inductors	152
Product Guide	154
● Inductors for Power Lines	
Part Numbering	156
Product Detail	158
⚠ Caution/Notice	189
Soldering and Mounting	191
Packaging	195
● Inductors for General Circuits	
Part Numbering	197
Product Detail	198
⚠ Caution/Notice	202
Soldering and Mounting	203
Packaging	206
● RF Inductors	
Part Numbering	207
Product Detail	208
⚠ Caution/Notice	228
Soldering and Mounting	230
Packaging	233

Classification and Structure of Chip Inductors

●Line Up and Applications for Chip Inductors

	Line Up	Applications
For Power Lines / For Low Frequency Circuits (Under 100MHz)	Wire Wound Type Ferrite Core  LQH Series (With some exceptions.)	For Voltage Conversion For Choke For Resonance Circuits For Low Frequency Filter Circuits
	Multilayer Type Ferrite Core  LQM Series	
RF Inductors (Greater than 100MHz)	Wire Wound Type Non-magnetic Core  LQW_A Series	For Impedance Matching For High Frequency Filter Circuits For RF Choke
	Multilayer Type Non-magnetic Material  LQG Series	
	Film Type Non-magnetic Material  LQP Series	

△Note • Please read rating and △CAUTION (for storage, operating, rating, soldering, mounting and handling) in this catalog to prevent smoking and/or burning, etc.
• This catalog has only typical specifications. Therefore, please approve our product specifications or transact the approval sheet for product specifications before ordering.

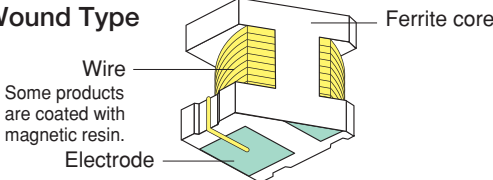
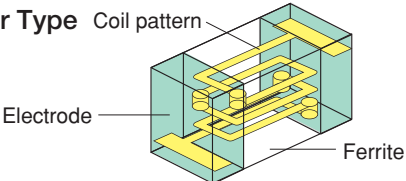
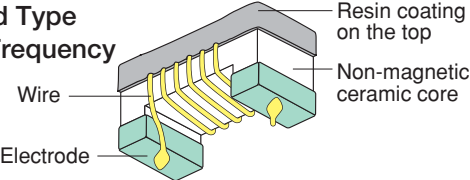
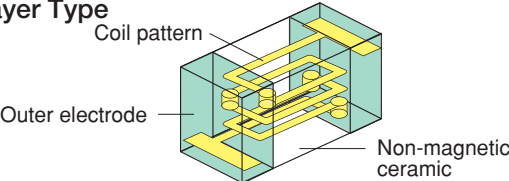
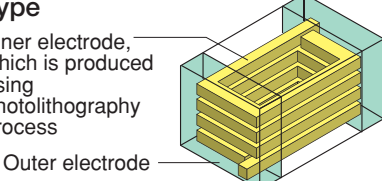

● Construction and Features of Chip Inductors

	Construction	Features
For Power Lines / For General Circuits (Under 100MHz)	Wire Wound Type  <p>Wire Some products are coated with magnetic resin. Electrode Ferrite core</p>	Wide inductance range Good DC bias current characteristics
	Multilayer Type  <p>Coil pattern Electrode Ferrite</p>	Small and lightweight Low DC resistance
RF Inductors (Greater than 100MHz)	Wire Wound Type For Radio Frequency  <p>Resin coating on the top Non-magnetic ceramic core Wire Electrode</p>	High Q Large inductance
	Multilayer Type  <p>Coil pattern Outer electrode Non-magnetic ceramic</p>	Industrial standard design
	Film Type  <p>Inner electrode, which is produced using photolithography process Outer electrode</p>	Small size, but high Q

⚠Note • Please read rating and ⚠CAUTION (for storage, operating, rating, soldering, mounting and handling) in this catalog to prevent smoking and/or burning, etc.
 • This catalog has only typical specifications. Therefore, please approve our product specifications or transact the approval sheet for product specifications before ordering.

Chip Inductors Product Guide

Murata's LQ□ series of chip inductors (chip coils) consists of compact, high-performance inductors. Their innovative coil and case structures mean low DC resistance and outstanding high-frequency characteristics. The series is designed for a variety of applications, facilitating component selection for individual circuit requirements.

	Part Number	Structure	Size Code in inch (in mm)	Inductance Range (H)							
				1n	10n	100n	1μ	10μ	100μ	1m	10m
Inductors for Power Lines	LQH2HPZ_JR ^{p183}	Wire Wound Type (Ferrite Core)	1008 (2520)				0.47μH	22μH			
	LQH3NPZ_JR ^{p171}		1212 (3030)				0.68μH	47μH			
	LQH32PZ_N0 ^{p173}		1210 (3225)				0.47μH	120μH			
	LQH32PZ_NC ^{p175}		1210 (3225)				0.47μH	22μH			
	LQH43PZ_26 ^{p177}		1812 (4532)				1.0μH	220μH			
	LQH44PZ_GR ^{p179}		1515 (4040)				0.68μH	47μH			
	LQH5BPZ_T0 ^{p181}		2020 (5050)				0.47μH	22μH			
	LQH32DZ_23 ^{p185}		1210 (3225)				1.0μH	330μH			
	LQH32DZ_53 ^{p186}		1210 (3225)				1.0μH	100μH			
	LQH32CH_23 ^{p187}		1210 (3225)				1.0μH	22μH			
	LQH32CH_33 ^{p187}		1210 (3225)			0.15μH	10μH				
	LQH32CH_53 ^{p188}		1210 (3225)				1.0μH	22μH			
	LQM21PZ_C0 ^{p158}	Multilayer Type (Ferrite Core)	0805 (2012)				0.47μH	2.2μH			
	LQM21PZ_G0 ^{p159}		0805 (2012)				0.47μH	3.3μH			
	LQM21P_GC ^{p160}		0805 (2012)				1.0μH	2.2μH			
	LQM21PZ_GR ^{p161}		0805 (2012)				1.0μH	4.7μH			
	LQM2MPZ_G0 ^{p162}		0806 (2016)				0.47μH	4.7μH			
	LQM2HPZ_G0 ^{p166}		1008 (2520)				0.47μH	4.7μH			
	LQM2HPZ_GS ^{p168}		1008 (2520)				2.2μH	4.7μH			
	LQM2HPZ_GC ^{p169}		1008 (2520)				1.0μH	4.7μH			
LQM2HPZ_J0 ^{p164}	1008 (2520)					1.0μH	3.3μH				
LQM2HPZ_JC ^{p165}	1008 (2520)					1.0μH	2.2μH				
LQM2HPZ_E0 ^{p170}	1008 (2520)				0.56μH						
Inductors for General Circuits	LQH31HZ_03 ^{p198}	Wire Wound Type (Ferrite Core)	1206 (3216)			54nH	880nH				
	LQH43NZ_03 ^{p199}		1812 (4532)				1.0μH	2200μH			
RF Inductors	LQG15H_02 ^{p208}	Multilayer Type (Non-Magnetic Core)	0402 (1005)	1.0nH	270nH						
	LQG18HH_00 ^{p210}		0603 (1608)	1.2nH	270nH						
	LQP03TN_Z2 ^{p212}	Film Type (Non-Magnetic Core)	0201 (0603)	0.6nH	120nH						
	LQW15AN_0Z ^{p216}	Wire Wound Type (Non-Magnetic Core)	0402 (1005)	1.5nH	120nH						
	LQW15AN_1Z ^{p222}		0402 (1005)	1.3nH	8.4nH						
	LQW18AN_0Z ^{p224}		0603 (1608)	2.2nH	470nH						
LQW18AN_1Z ^{p227}	0603 (1608)		2.2nH	33nH							

Inductance Lineup

- : E-24 or Higher
- : E-12
- : 0.1nH Step
- : Other

*There are some items that do not match to E step.

CAUTION: Use rosin-based flux, but not strong acidic flux (with chlorine content exceeding 0.2wt%) when soldering chip inductors (chip coils). Do not use water-soluble flux.

△Note • Please read rating and △CAUTION (for storage, operating, rating, soldering, mounting and handling) in this catalog to prevent smoking and/or burning, etc.
• This catalog has only typical specifications. Therefore, please approve our product specifications or transact the approval sheet for product specifications before ordering.



	Part Number	Rated Current (A)				Thickness max.	Low Rdc	Bias	E-12 Step	E-24 Step	Hi Q	Tight Tolerance	Flow OK
		10m	100m	1	10								
Inductors for Power Lines	LQH2HPZ_JR ^{p183}		540mA	2.75A		1.2mm	Low Rdc						
	LQH3NPZ_JR ^{p171}		570mA	2.86A		1.2mm	Low Rdc						
	LQH32PZ_N0 ^{p173}		200mA	2.55A		1.7mm							
	LQH32PZ_NC ^{p175}		550mA	2.9A		1.7mm		Bias					
	LQH43PZ_26 ^{p177}		240mA	3.3A		2.8mm							
	LQH44PZ_GR ^{p179}		410mA	2.5A		1.0mm	Low Rdc						
	LQH5BPZ_T0 ^{p181}		1.05A	4A		2.2mm							
	LQH32DZ_23 ^{p185}	60mA	800mA			2.2mm							
	LQH32DZ_53 ^{p186}	100mA	1A			1.7mm							
	LQH32CH_23 ^{p187}	250mA	800mA			2.2mm						Flow	
	LQH32CH_33 ^{p187}	450mA	1.45A			2.2mm						Flow	
	LQH32CH_53 ^{p188}	250mA	1A			1.7mm						Flow	
	LQM21PZ_C0 ^{p158}	600mA	1.1A			0.55mm						Flow	
	LQM21PZ_G0 ^{p159}	800mA	1.3A			1.0mm						Flow	
	LQM21P_GC ^{p160}	800mA	900mA			1.0mm		Bias				Flow	
	LQM21PZ_GR ^{p161}	800mA	1.3A			1.0mm	Low Rdc					Flow	
	LQM2MPZ_G0 ^{p162}	1.1A	1.6A			1.0mm						Flow	
	LQM2HPZ_G0 ^{p166}	1.1A	1.8A			1.0mm						Flow	
	LQM2HPZ_GS ^{p168}	1A	1.1A			1.0mm						Flow	
	LQM2HPZ_GC ^{p169}	800mA	1.5A			1.0mm		Bias				Flow	
LQM2HPZ_J0 ^{p164}	1A	1.5A			1.2mm						Flow		
LQM2HPZ_JC ^{p165}	1A	1.5A			1.2mm		Bias				Flow		
LQM2HPZ_E0 ^{p170}		1.5A			0.8mm						Flow		
Inductors for General Circuits	LQH31HZ_03 ^{p198}	180mA	920mA			2.0mm						Flow	
	LQH43NZ_03 ^{p199}	30mA	500mA			2.8mm		E-12					
RF Inductors	LQG15H_02 ^{p208}	110mA	300mA			0.55mm		E-12	E-24				
	LQG18HH_00 ^{p210}	200mA	1.1A			0.95mm		E-12					
	LQP03TN_Z2 ^{p212}	80mA	850mA			0.33mm		E-12	E-24		Tight		
	LQW15AN_0Z ^{p216}	110mA	1A			0.6mm			E-24		Tight		
	LQW15AN_1Z ^{p222}	640mA	1.2A			0.6mm	Low Rdc	E-12		High Q	Tight		
	LQW18AN_0Z ^{p224}	75mA	850mA			1.0mm		E-12	E-24		Tight		
	LQW18AN_1Z ^{p227}	550mA	1.4A			1.0mm	Low Rdc	E-12		High Q	Tight		

⚠Note • Please read rating and ⚠CAUTION (for storage, operating, rating, soldering, mounting and handling) in this catalog to prevent smoking and/or burning, etc.
 • This catalog has only typical specifications. Therefore, please approve our product specifications or transact the approval sheet for product specifications before ordering.



Inductors for Power Lines Part Numbering

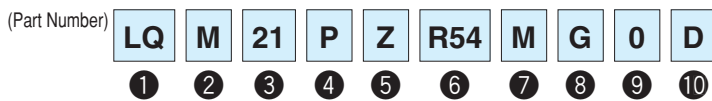

① Product ID

Product ID	
LQ	Chip Inductors (Chip Coils)

② Structure

Code	Structure
H	Wire Wound Type (Ferrite Core)
M	Multilayer Type (Ferrite Core)

③ Dimensions (L×W)

Code	Dimensions (L×W)	Size Code (in inch)
21	2.0×1.25mm	0805
2M	2.0×1.6mm	0806
2H	2.5×2.0mm	1008
3N	3.0×3.0mm	1212
32	3.2×2.5mm	1210
43	4.5×3.2mm	1812
44	4.0×4.0mm	1515
5B	5.0×5.0mm	2020

④ Applications and Characteristics

Code	Series	Applications and Characteristics
D	LQH	for Choke
C	LQH	for Choke (Coating Type)
P	LQM/LQH	for Power Line

⑤ Category

Code	Category	
Z	Automotive	Infotainment
H		Powertrain/Safety

⑥ Inductance

Expressed by three-digit alphanumerics. The unit is micro-henry (μH). The first and second figures are significant digits, and the third figure expresses the number of zeros that follow the two figures. If there is a decimal point, it is expressed by the capital letter "R." In this case, all figures are significant digits. If inductance is less than $0.1\mu\text{H}$, the inductance code is expressed by a combination of two figures and the capital letter "N," and the unit of inductance is nano-henry (nH).

The capital letter "N" indicates the unit of "nH," and also expresses a decimal point. In this case, all figures are significant digits.

⑦ Inductance Tolerance

Code	Inductance Tolerance
K	$\pm 10\%$
M	$\pm 20\%$
N	$\pm 30\%$

⑧ Features (Except for LQH□□P/LQM□□P)

Code	Features	Series
2	Standard Type	LQH32C/32D
3	Low DC Resistance	
5	Low Profile Type	

⑧ Thickness

(LQH□□P/LQM□□P Only • Except for LQH43P)

Code	Dimensions (T)
C	0.5mm
E	0.7mm
G	0.9mm
J	1.1mm
N	1.55mm
T	2.0mm

⑨ Electrode (Except for LQH□□P/LQM□□P)

•Lead (Pb) Free

Code	Electrode	Series
0	Sn	LQM/LQW
3	LF Solder	LQH

⑨ Specification

(LQH□□P/LQM□□P Only • Except for LQH43P)

Code	Specification
0/S	Standard Type
C	Good Bias Current Characteristics Type
R	Low DC Resistance Type

Continued on the following page.

△Note • Please read rating and △CAUTION (for storage, operating, rating, soldering, mounting and handling) in this catalog to prevent smoking and/or burning, etc.
• This catalog has only typical specifications. Therefore, please approve our product specifications or transact the approval sheet for product specifications before ordering.

⑧⑨ Thickness (LQH43P Only)

Code	Dimensions (T)
26	2.6mm

⑩ Packaging

Code	Packaging	Series
K	Embossed Taping (ø330mm Reel)	LQH*1
L	Embossed Taping (ø180mm Reel)	LQH/LQM2HP/LQM2MP
B	Bulk	LQM
D	Paper Taping (ø180mm Reel)	LQM21P

*1 Except for LQH2HP_JR/LQH3NP_JR

Multilayer Type (Ferrite Core)

LQM21PZ_C0 Series 0805/2012 (inch/mm)

Size Code 0805 (2012) in inch (in mm), 0.55mm max. Thickness

■ Appearance/Dimensions

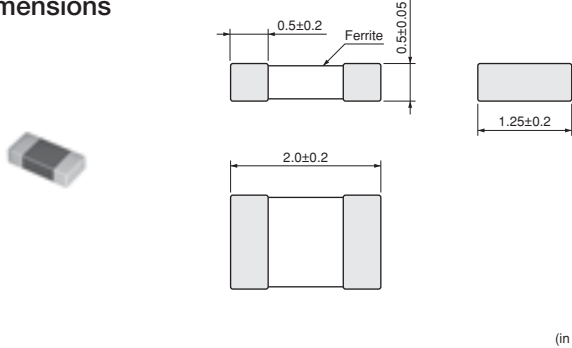

■ Packaging

Code	Packaging	Minimum Quantity
D	ø180mm Paper Taping	4000
B	Packing in Bulk	1000

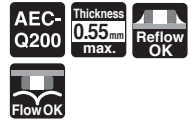

Refer to pages from p.191 to p.194 for mounting information.

■ Rated Value (□: packaging code)

Part Number		Inductance	Inductance Test Frequency	Rated Current	DC Resistance	Self-Resonance Frequency (min.)
For Infotainment	For Powertrain/Safety					
LQM21PZR47MC0□	—	0.47μH ±20%	1MHz	1100mA	0.12Ω ±25%	100MHz
LQM21PZ1R0MC0□	—	1.0μH ±20%	1MHz	800mA	0.19Ω ±25%	90MHz
LQM21PZ1R5MC0□	—	1.5μH ±20%	1MHz	700mA	0.26Ω ±25%	70MHz
LQM21PZ2R2MC0□	—	2.2μH ±20%	1MHz	600mA	0.34Ω ±25%	50MHz

Class of Magnetic Shield: Magnetic shield of ferrite Operating Temperature Range: -55°C~+125°C

■ Inductance-Frequency Characteristics (Typ.)

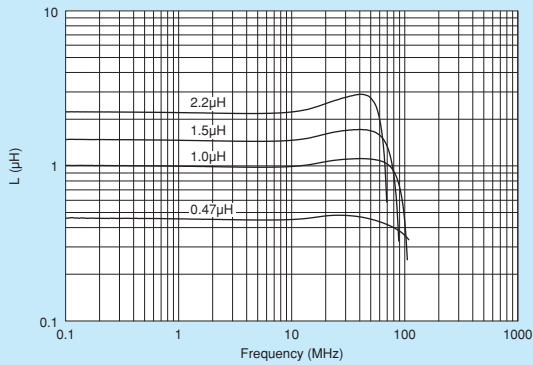

■ Inductance-Current Characteristics (Typ.)

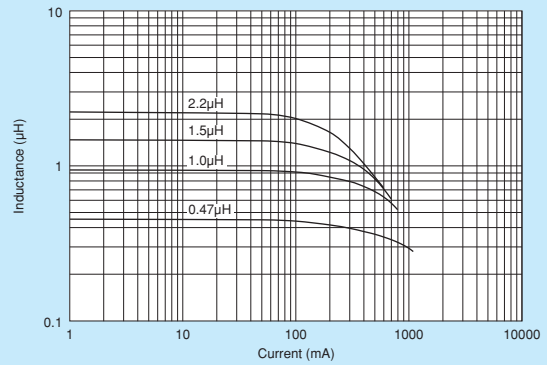

■ Temperature Rise Characteristics (Typ.)

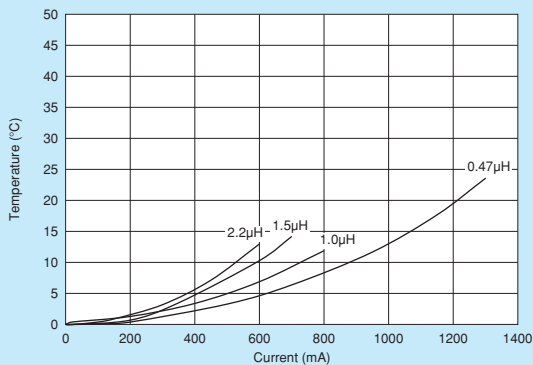

△Note • Please read rating and △CAUTION (for storage, operating, rating, soldering, mounting and handling) in this catalog to prevent smoking and/or burning, etc.
• This catalog has only typical specifications. Therefore, please approve our product specifications or transact the approval sheet for product specifications before ordering.

Multilayer Type (Ferrite Core)

LQM21PZ_G0

Series 0805/2012 (inch/mm)

Size Code 0805 (2012) in inch (in mm), 1.0mm max. Thickness

■ Appearance/Dimensions

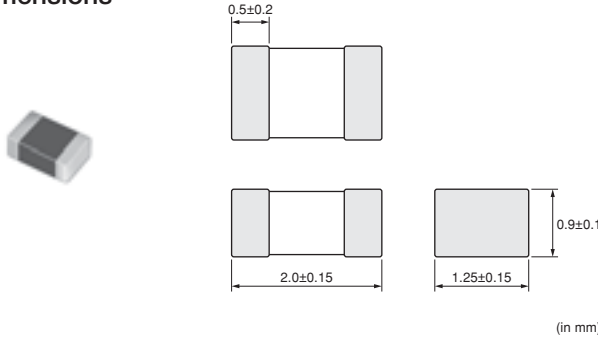

■ Packaging

Code	Packaging	Minimum Quantity
D	ø180mm Paper Taping	4000
B	Packing in Bulk	1000

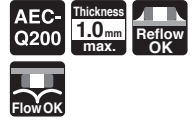

Refer to pages from p.191 to p.194 for mounting information.

■ Rated Value (□: packaging code)

Part Number		Inductance	Rated Current ^{*1}		DC Resistance	Self-Resonance Frequency (min.)
For Infotainment	For Powertrain/Safety		Ambient Temperature 85°C	Ambient Temperature 125°C		
LQM21PZR47MG0□	—	0.47μH ±20%	1.3A	0.95A	0.094Ω (max.) / 0.075Ω (typ.)	100MHz
LQM21PZR54MG0□	—	0.54μH ±20%	1.3A	0.95A	0.094Ω (max.) / 0.075Ω (typ.)	100MHz
LQM21PZR3MG0□	—	3.3μH ±20%	0.8A	0.55A	0.207Ω (max.) / 0.165Ω (typ.)	30MHz
LQM21PZR3NG0□	—	3.3μH ±30%	0.8A	0.55A	0.207Ω (max.) / 0.165Ω (typ.)	30MHz

Inductance Test Frequency: 1MHz Class of Magnetic Shield: Magnetic shield of ferrite

Operating Temperature Range: -55°C~+125°C

*1 When applied rated current to the products, temperature rise caused by self-generated heat shall be limited to 40°C max.

■ Inductance-Frequency Characteristics (Typ.)

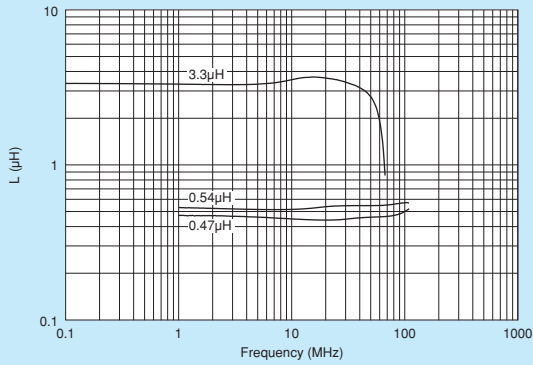

■ Inductance-Current Characteristics (Typ.)

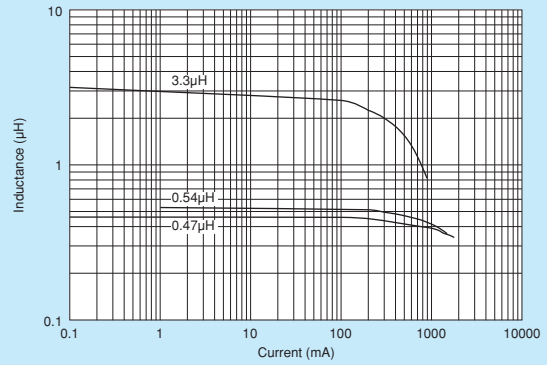

■ Temperature Rise Characteristics (Typ.)

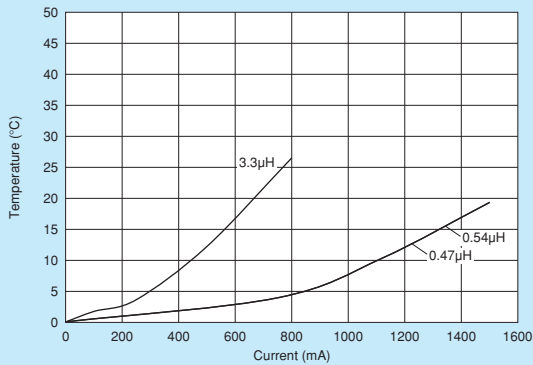

■ Derating of Rated Current

In operating temperature exceeding +85°C, derating of current is necessary for LQM21P_G0 series. Please apply the derating curve shown in chart according to the operating temperature.

Derating of Rated Current

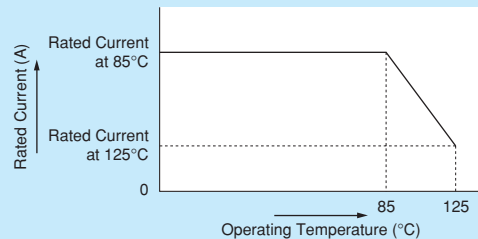

△Note • Please read rating and △CAUTION (for storage, operating, rating, soldering, mounting and handling) in this catalog to prevent smoking and/or burning, etc.
• This catalog has only typical specifications. Therefore, please approve our product specifications or transact the approval sheet for product specifications before ordering.

LQM21P_GC Series 0805/2012 (inch/mm)

Bias Current Characteristics Improved

Appearance/Dimensions

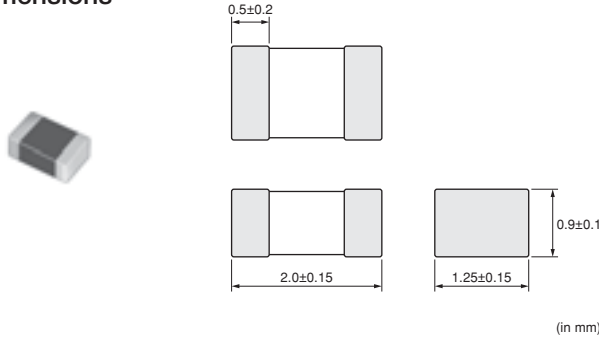

Packaging

Code	Packaging	Minimum Quantity
D	ø180mm Paper Taping	2000
B	Packing in Bulk	1000

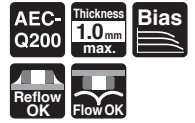

Refer to pages from p.191 to p.194 for mounting information.

Rated Value (□: packaging code)

Part Number		Inductance	Inductance Test Frequency	Rated Current	DC Resistance	Self-Resonance Frequency (min.)
For Infotainment	For Powertrain/Safety					
LQM21PZ1R0NGC□	—	1.0μH ±30%	1MHz	900mA	0.10Ω ±25%	50MHz
—	LQM21PH2R2MGC□	2.2μH ±20%	1MHz	800mA	0.23Ω ±25%	40MHz
LQM21PZ2R2NGC□	—	2.2μH ±30%	1MHz	800mA	0.23Ω ±25%	40MHz

Class of Magnetic Shield: Magnetic shield of ferrite Operating Temperature Range: -55°C~+125°C

Inductance-Frequency Characteristics (Typ.)

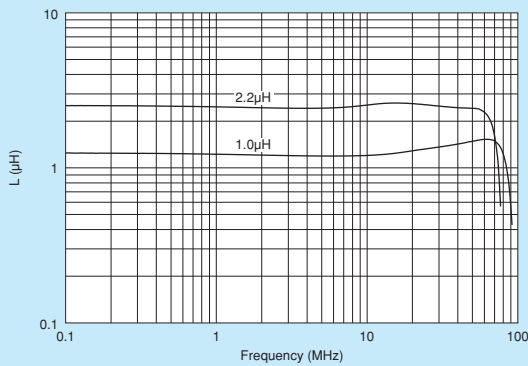

Inductance-Current Characteristics (Typ.)

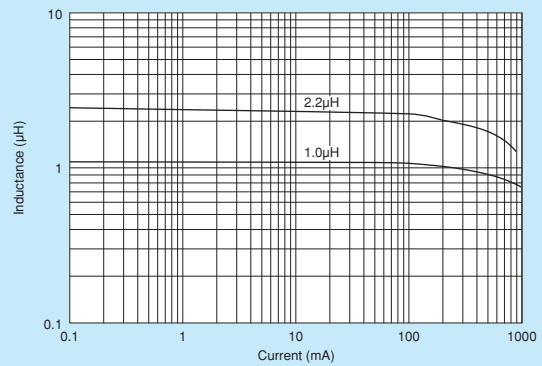

Temperature Rise Characteristics (Typ.)

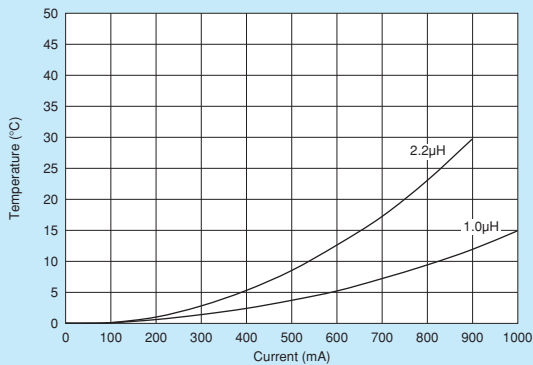

△Note • Please read rating and △CAUTION (for storage, operating, rating, soldering, mounting and handling) in this catalog to prevent smoking and/or burning, etc.
• This catalog has only typical specifications. Therefore, please approve our product specifications or transact the approval sheet for product specifications before ordering.

Multilayer Type (Ferrite Core)

LQM21PZ_GR Series 0805/2012 (inch/mm)

Low DC Resistance Type

Appearance/Dimensions

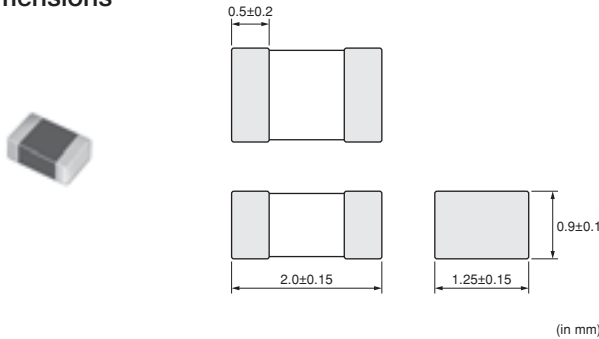

Packaging

Code	Packaging	Minimum Quantity
D	ø180mm Paper Taping	4000
B	Packing in Bulk	1000

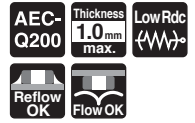

Refer to pages from p.191 to p.194 for mounting information.

Rated Value (□: packaging code)

Part Number		Inductance	Inductance Test Frequency	Rated Current	DC Resistance	Self-Resonance Frequency (min.)
For Infotainment	For Powertrain/Safety					
LQM21PZ1R0NGR□	—	1.0μH ±30%	1MHz	1300mA	0.066Ω ±25%	50MHz
LQM21PZ3R3MGR□	—	3.3μH ±20%	1MHz	1000mA	0.150Ω ±25%	30MHz
LQM21PZ3R3NGR□	—	3.3μH ±30%	1MHz	1000mA	0.150Ω ±25%	30MHz
LQM21PZ4R7MGR□	—	4.7μH ±20%	1MHz	800mA	0.23Ω ±25%	30MHz
LQM21PZ4R7NGR□	—	4.7μH ±30%	1MHz	800mA	0.23Ω ±25%	30MHz

Class of Magnetic Shield: Magnetic shield of ferrite Operating Temperature Range: -55°C~+125°C

Inductance-Frequency Characteristics (Typ.)

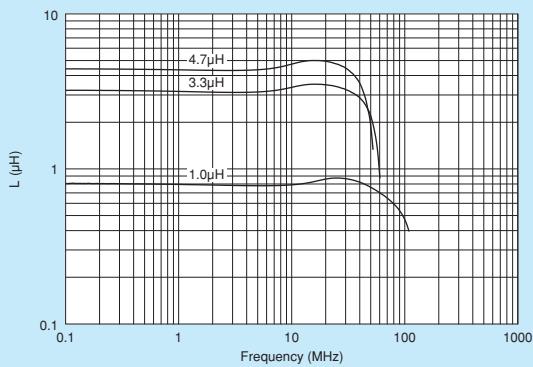

Inductance-Current Characteristics (Typ.)

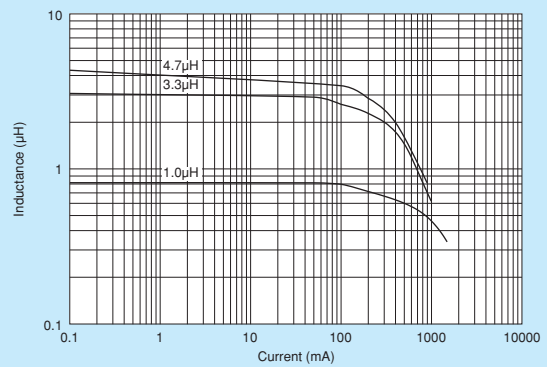

Temperature Rise Characteristics (Typ.)

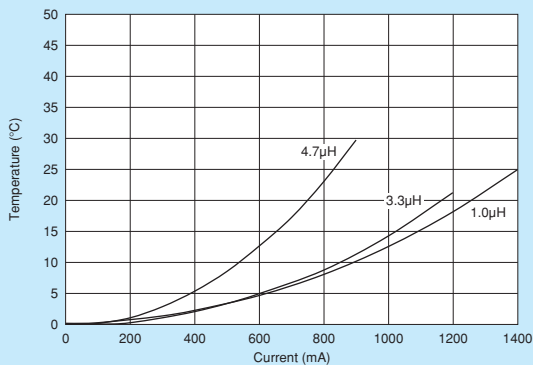

△Note • Please read rating and △CAUTION (for storage, operating, rating, soldering, mounting and handling) in this catalog to prevent smoking and/or burning, etc.
• This catalog has only typical specifications. Therefore, please approve our product specifications or transact the approval sheet for product specifications before ordering.

Multilayer Type (Ferrite Core)

LQM2MPZ_GO Series 0806/2016 (inch/mm)

Size Code 0806 (2016) in inch (in mm), 1.0mm max. Thickness

■ Appearance/Dimensions

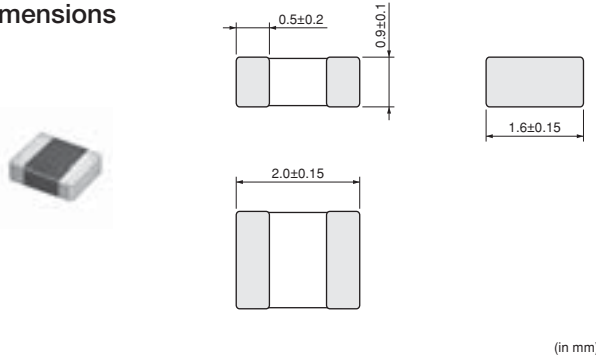

■ Packaging

Code	Packaging	Minimum Quantity
L	ø180mm Embossed Taping	3000
B	Packing in Bulk	1000

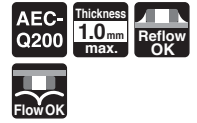

Refer to pages from p.191 to p.194 for mounting information.

■ Rated Value (□: packaging code)

Part Number		Inductance	Rated Current ^{†1}		DC Resistance	Self-Resonance Frequency (min.)
For Infotainment	For Powertrain/Safety		Ambient Temperature 85°C	Ambient Temperature 125°C		
LQM2MPZR47MG0□	—	0.47µH ±20%	1.6A	1.2A	0.075Ω (max.) / 0.060Ω (typ.)	100MHz
LQM2MPZR47NG0□	—	0.47µH ±30%	1.6A	1.2A	0.075Ω (max.) / 0.060Ω (typ.)	100MHz
LQM2MPZ1R0NG0□	—	1.0µH ±30%	1.4A	1.0A	0.107Ω (max.) / 0.085Ω (typ.)	60MHz
LQM2MPZ1R5MG0□	—	1.5µH ±20%	1.2A	0.9A	0.138Ω (max.) / 0.11Ω (typ.)	50MHz
LQM2MPZ1R5NG0□	—	1.5µH ±30%	1.2A	0.9A	0.138Ω (max.) / 0.11Ω (typ.)	50MHz
LQM2MPZ2R2MG0□	—	2.2µH ±20%	1.2A	0.9A	0.138Ω (max.) / 0.11Ω (typ.)	40MHz
LQM2MPZ2R2NG0□	—	2.2µH ±30%	1.2A	0.9A	0.138Ω (max.) / 0.11Ω (typ.)	40MHz
LQM2MPZ3R3NG0□	—	3.3µH ±30%	1.2A	0.9A	0.15Ω (max.) / 0.12Ω (typ.)	30MHz
LQM2MPZ4R7MG0□	—	4.7µH ±20%	1.1A	0.8A	0.175Ω (max.) / 0.14Ω (typ.)	20MHz
LQM2MPZ4R7NG0□	—	4.7µH ±30%	1.1A	0.8A	0.175Ω (max.) / 0.14Ω (typ.)	20MHz

Inductance Test Frequency: 1MHz Class of Magnetic Shield: Magnetic shield of ferrite
 Operating Temperature Range: -55°C~+125°C

^{†1} When applied rated current to the products, temperature rise caused by self-generated heat shall be limited to 40°C max.

■ Inductance-Frequency Characteristics (Typ.)

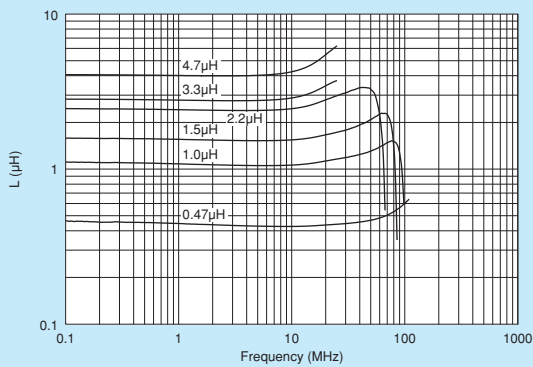

■ Inductance-Current Characteristics (Typ.)

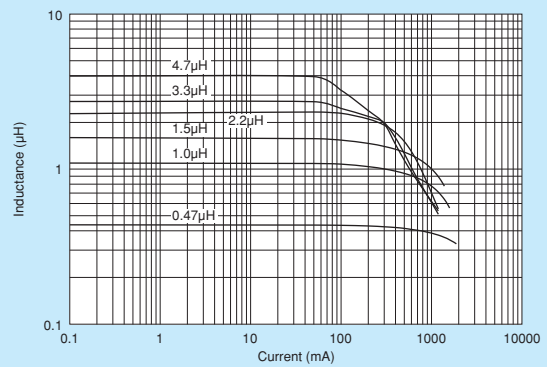

Continued on the following page.

[△]Note • Please read rating and [△]CAUTION (for storage, operating, rating, soldering, mounting and handling) in this catalog to prevent smoking and/or burning, etc.
 • This catalog has only typical specifications. Therefore, please approve our product specifications or transact the approval sheet for product specifications before ordering.

■ Temperature Rise Characteristics (Typ.)

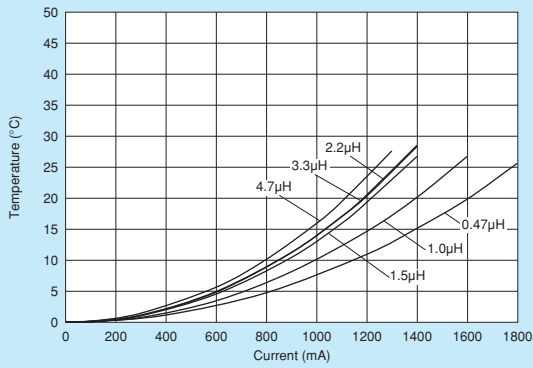

■ Derating of Rated Current

In operating temperature exceeding +85°C, derating of current is necessary for LQM2MP_G0 series. Please apply the derating curve shown in chart according to the operating temperature.

Derating of Rated Current

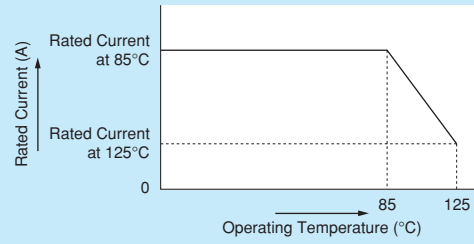

⚠Note • Please read rating and ⚠CAUTION (for storage, operating, rating, soldering, mounting and handling) in this catalog to prevent smoking and/or burning, etc.
• This catalog has only typical specifications. Therefore, please approve our product specifications or transact the approval sheet for product specifications before ordering.

Multilayer Type (Ferrite Core)

LQM2HPZ_J0

Series 1008/2520 (inch/mm)

Size Code 1008 (2520) in inch (in mm), 1.2mm max. Thickness

■ Appearance/Dimensions

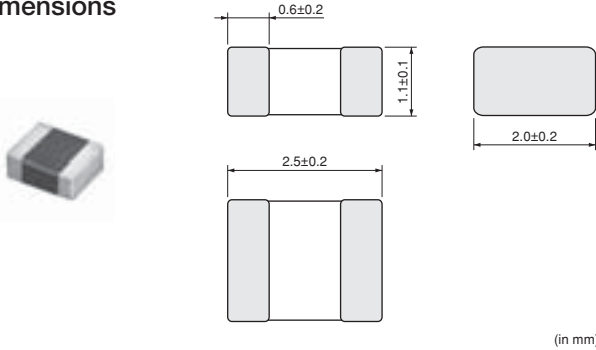

■ Packaging

Code	Packaging	Minimum Quantity
L	ø180mm Embossed Taping	3000
B	Packing in Bulk	1000

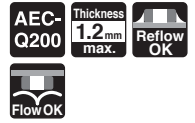

Refer to pages from p.191 to p.194 for mounting information.

■ Rated Value (□: packaging code)

Part Number		Inductance	Inductance Test Frequency	Rated Current	DC Resistance	Self-Resonance Frequency (min.)
For Infotainment	For Powertrain/Safety					
LQM2HPZ1R0MJ0□	—	1.0μH ±20%	1MHz	1500mA	0.09Ω ±25%	70MHz
LQM2HPZ2R2MJ0□	—	2.2μH ±20%	1MHz	1000mA	0.12Ω ±25%	40MHz
LQM2HPZ3R3MJ0□	—	3.3μH ±20%	1MHz	1000mA	0.12Ω ±25%	30MHz

Class of Magnetic Shield: Magnetic shield of ferrite Operating Temperature Range: -55°C~+125°C

■ Inductance-Frequency Characteristics (Typ.)

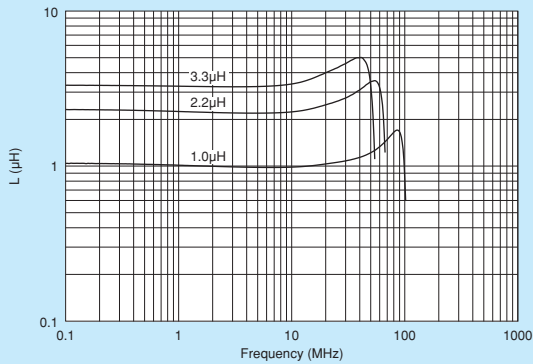

■ Inductance-Current Characteristics (Typ.)

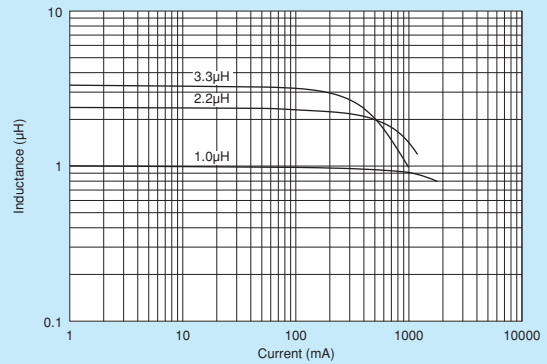

■ Temperature Rise Characteristics (Typ.)

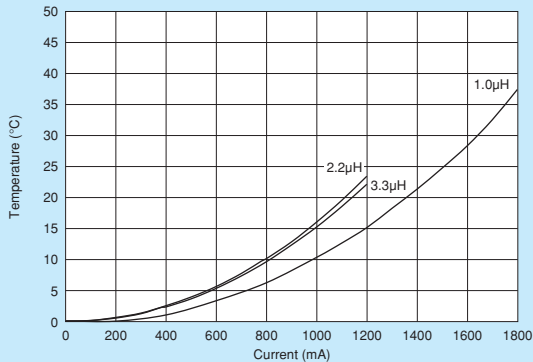

△Note • Please read rating and △CAUTION (for storage, operating, rating, soldering, mounting and handling) in this catalog to prevent smoking and/or burning, etc.
• This catalog has only typical specifications. Therefore, please approve our product specifications or transact the approval sheet for product specifications before ordering.

Multilayer Type (Ferrite Core)

LQM2HPZ_JC Series 1008/2520 (inch/mm)

Bias Current Characteristics Improved

Appearance/Dimensions

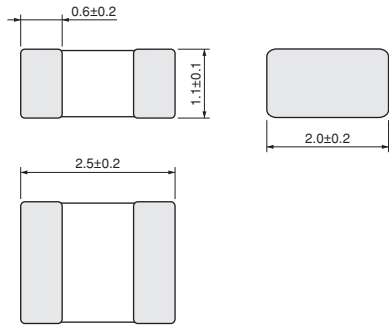

(in mm)

Packaging

Code	Packaging	Minimum Quantity
L	ø180mm Embossed Taping	3000
B	Packing in Bulk	1000

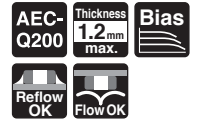

Refer to pages from p.191 to p.194 for mounting information.

Rated Value (□: packaging code)

Part Number		Inductance	Inductance Test Frequency	Rated Current	DC Resistance	Self-Resonance Frequency (min.)
For Infotainment	For Powertrain/Safety					
LQM2HPZ1R0MJC□	—	1.0μH ±20%	1MHz	1500mA	0.086Ω ±25%	50MHz
LQM2HPZ2R2NJC□	—	2.2μH ±30%	1MHz	1000mA	0.175Ω ±25%	30MHz

Class of Magnetic Shield: Magnetic shield of ferrite Operating Temperature Range: -55°C~+125°C

Inductance-Frequency Characteristics (Typ.)

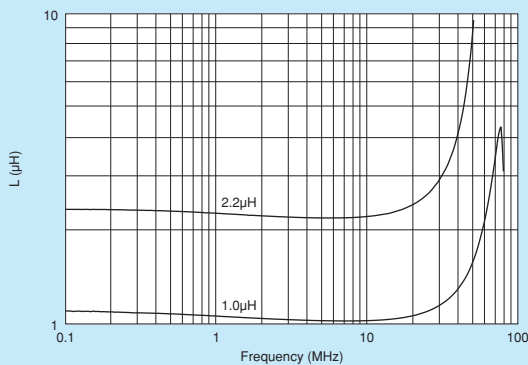

Inductance-Current Characteristics (Typ.)

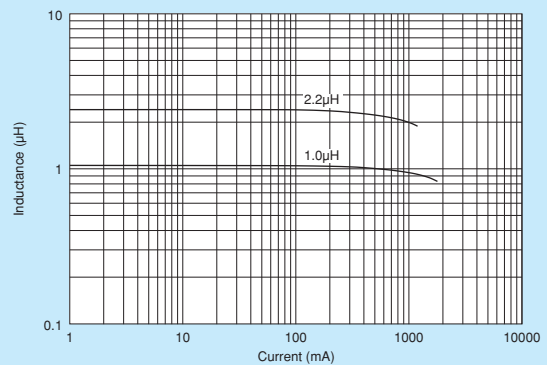

Temperature Rise Characteristics (Typ.)

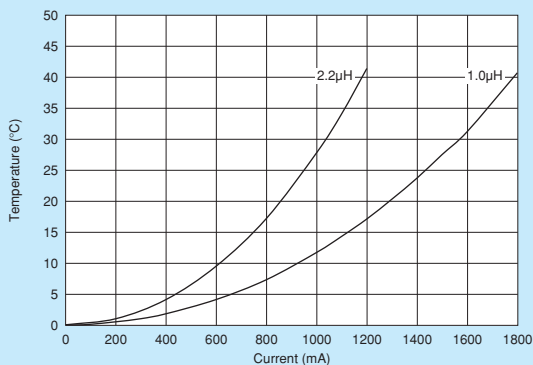

△Note • Please read rating and △CAUTION (for storage, operating, rating, soldering, mounting and handling) in this catalog to prevent smoking and/or burning, etc.
• This catalog has only typical specifications. Therefore, please approve our product specifications or transact the approval sheet for product specifications before ordering.

Multilayer Type (Ferrite Core)

LQM2HPZ_GO Series 1008/2520 (inch/mm)

Size Code 1008 (2520) in inch (in mm), 1.0mm max. Thickness

■ Appearance/Dimensions

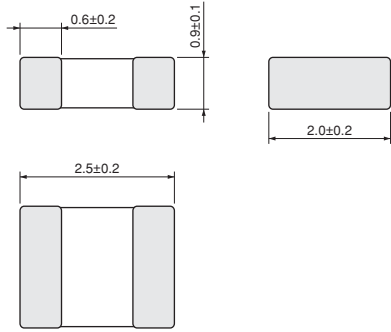

(in mm)

■ Packaging

Code	Packaging	Minimum Quantity
L	ø180mm Embossed Taping	3000
B	Packing in Bulk	1000

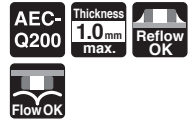

Refer to pages from p.191 to p.194 for mounting information.

■ Rated Value (□: packaging code)

Part Number		Inductance	DC Resistance	Rated Current ^{*1}		Self-Resonance Frequency (min.)
For Infotainment	For Powertrain/Safety			Ambient Temperature 85°C	Ambient Temperature 125°C	
LQM2HPZR47MG0□	—	0.47μH ±20%	0.050 Ω (max.)/0.040 Ω (typ.)	1.8A	1.3A	100MHz
LQM2HPZ1R0MG0□	—	1.0μH ±20%	0.069 Ω (max.)/0.055 Ω (typ.)	1.6A	1.2A	60MHz
LQM2HPZ1R5MG0□	—	1.5μH ±20%	0.088 Ω (max.)/0.070 Ω (typ.)	1.5A	1.1A	50MHz
LQM2HPZ2R2MG0□	—	2.2μH ±20%	0.10 Ω (max.)/0.080 Ω (typ.)	1.3A	0.97A	40MHz
LQM2HPZ3R3MG0□	—	3.3μH ±20%	0.125 Ω (max.)/0.10 Ω (typ.)	1.2A	0.9A	30MHz
LQM2HPZ4R7MG0□	—	4.7μH ±20%	0.138 Ω (max.)/0.11 Ω (typ.)	1.1A	0.82A	25MHz

Inductance Test Frequency: 1MHz Class of Magnetic Shield: Magnetic shield of ferrite Operating Temperature Range: -55°C~+125°C

*1 When applied rated current to the products, temperature rise caused by self-generated heat shall be limited to 40°C max.

■ Inductance-Frequency Characteristics (Typ.)

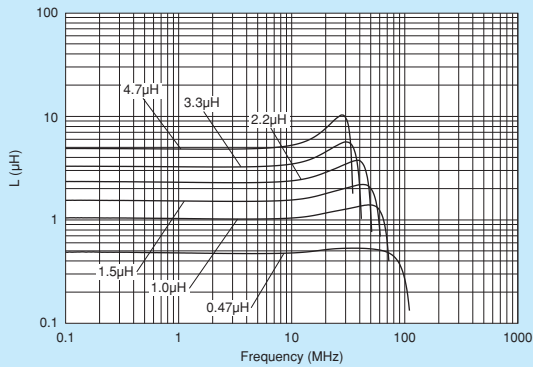

■ Inductance-Current Characteristics (Typ.)

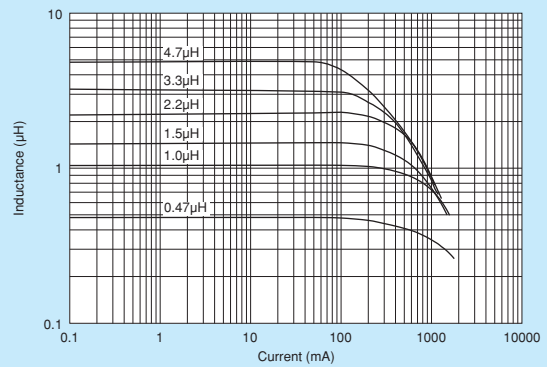

Continued on the following page.

△Note • Please read rating and △CAUTION (for storage, operating, rating, soldering, mounting and handling) in this catalog to prevent smoking and/or burning, etc.
• This catalog has only typical specifications. Therefore, please approve our product specifications or transact the approval sheet for product specifications before ordering.

■ Temperature Rise Characteristics (Typ.)

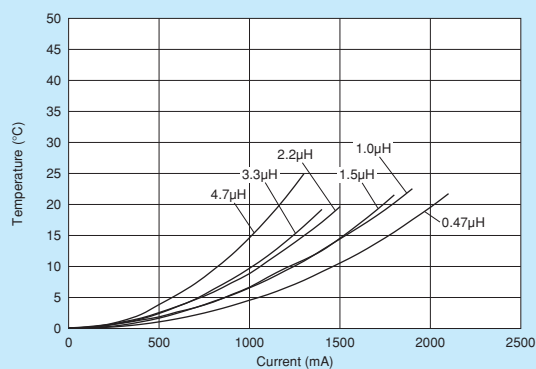

■ Derating of Rated Current

In operating temperature exceeding +85°C, derating of current is necessary for LQM2HP_G0 series. Please apply the derating curve shown in chart according to the operating temperature.

Derating of Rated Current

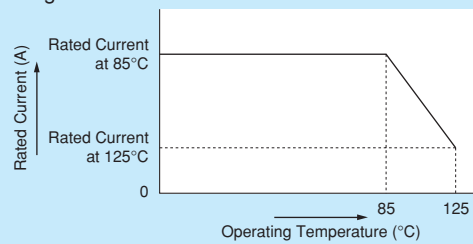

⚠Note • Please read rating and ⚠CAUTION (for storage, operating, rating, soldering, mounting and handling) in this catalog to prevent smoking and/or burning, etc.
• This catalog has only typical specifications. Therefore, please approve our product specifications or transact the approval sheet for product specifications before ordering.

Multilayer Type (Ferrite Core)

LQM2HPZ_GS Series 1008/2520 (inch/mm)

Size Code 1008 (2520) in inch (in mm), 1.0mm max. Thickness

■ Appearance/Dimensions

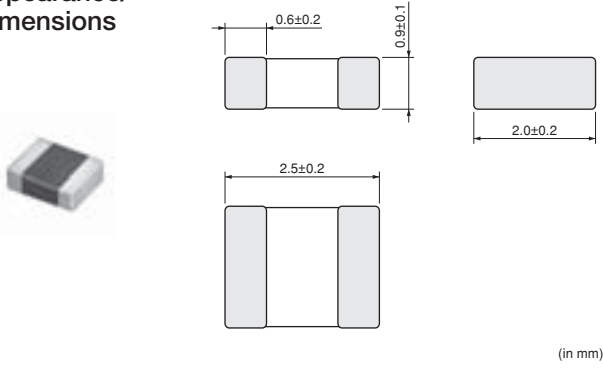

■ Packaging

Code	Packaging	Minimum Quantity
L	ø180mm Embossed Taping	3000
B	Packing in Bulk	1000

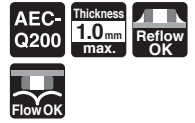

Refer to pages from p.191 to p.194 for mounting information.

■ Rated Value (□: packaging code)

Part Number		Inductance	Inductance Test Frequency	Rated Current	DC Resistance	Self-Resonance Frequency (min.)
For Infotainment	For Powertrain/Safety					
LQM2HPZ2R2MGS□	—	2.2μH ±20%	1MHz	1100mA	0.18Ω ±25%	40MHz
LQM2HPZ3R3MGS□	—	3.3μH ±20%	1MHz	1050mA	0.21Ω ±25%	20MHz
LQM2HPZ4R7MGS□	—	4.7μH ±20%	1MHz	1000mA	0.25Ω ±25%	20MHz

Class of Magnetic Shield: Magnetic shield of ferrite Operating Temperature Range: -40°C~+85°C

■ Inductance-Frequency Characteristics (Typ.)

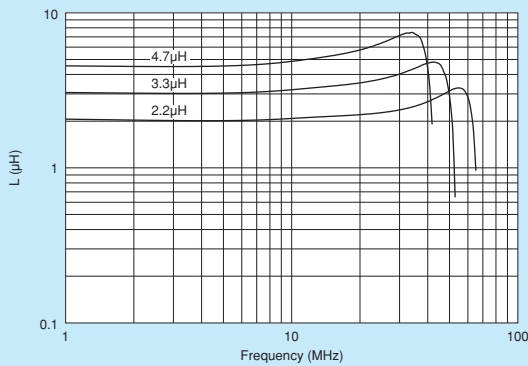

■ Inductance-Current Characteristics (Typ.)

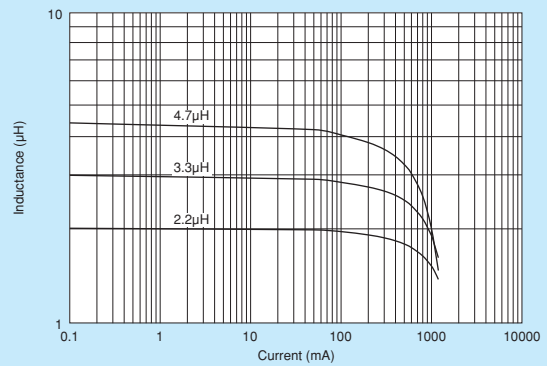

■ Temperature Rise Characteristics (Typ.)

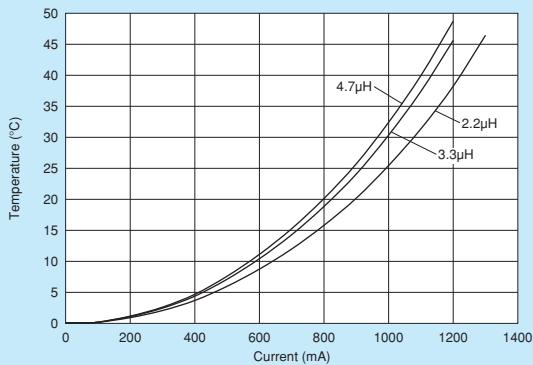

△Note • Please read rating and △CAUTION (for storage, operating, rating, soldering, mounting and handling) in this catalog to prevent smoking and/or burning, etc.
• This catalog has only typical specifications. Therefore, please approve our product specifications or transact the approval sheet for product specifications before ordering.

Multilayer Type (Ferrite Core)

LQM2HPZ_GC Series 1008/2520 (inch/mm)

Bias Current Characteristics Improved

Appearance/Dimensions

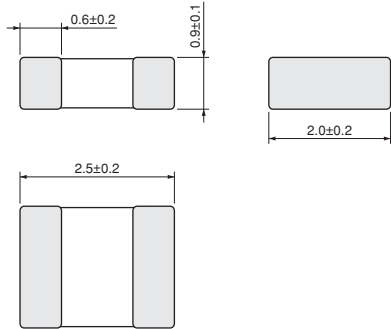

(in mm)

Packaging

Code	Packaging	Minimum Quantity
L	ø180mm Embossed Taping	3000
B	Packing in Bulk	1000

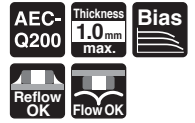

Refer to pages from p.191 to p.194 for mounting information.

Rated Value (□: packaging code)

Part Number		Inductance	Inductance Test Frequency	Rated Current	DC Resistance	Self-Resonance Frequency (min.)	Operating Temperature Range
For Infotainment	For Powertrain/Safety						
LQM2HPZ1R0MGC□	—	1.0μH ±20%	1MHz	1500mA	0.08Ω ±25%	50MHz	-30°C~+85°C
LQM2HPZ3R3MGC□	—	3.3μH ±20%	1MHz	1000mA	0.16Ω ±25%	30MHz	-55°C~+125°C
LQM2HPZ4R7MGC□	—	4.7μH ±20%	1MHz	800mA	0.18Ω ±25%	25MHz	-55°C~+125°C

Class of Magnetic Shield: Magnetic shield of ferrite

Inductance-Frequency Characteristics (Typ.)

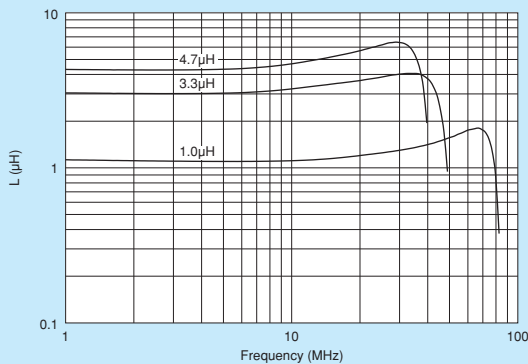

Inductance-Current Characteristics (Typ.)

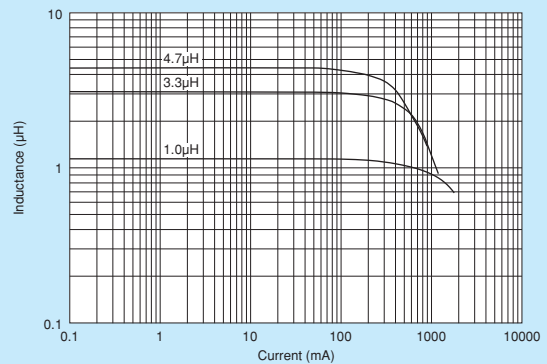

Temperature Rise Characteristics (Typ.)

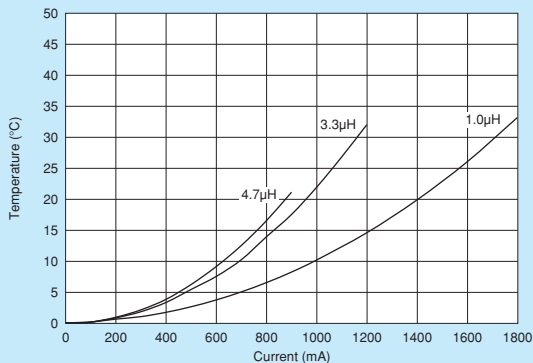

⚠Note • Please read rating and ⚠CAUTION (for storage, operating, rating, soldering, mounting and handling) in this catalog to prevent smoking and/or burning, etc.
• This catalog has only typical specifications. Therefore, please approve our product specifications or transact the approval sheet for product specifications before ordering.

Multilayer Type (Ferrite Core)

LQM2HPZ_E0

Series 1008/2520 (inch/mm)

Size Code 1008 (2520) in inch (in mm), 0.8mm max. Thickness

■ Appearance/Dimensions

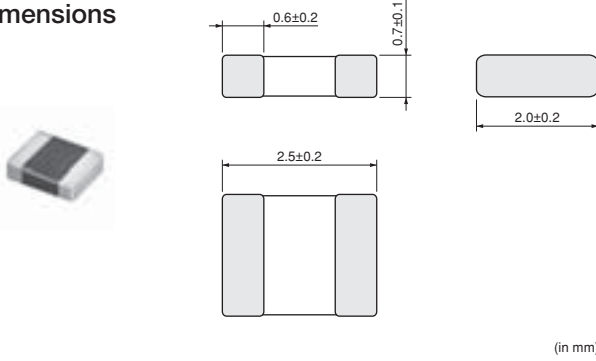

■ Packaging

Code	Packaging	Minimum Quantity
L	ø180mm Embossed Taping	3000
B	Packing in Bulk	1000

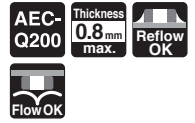

Refer to pages from p.191 to p.194 for mounting information.

■ Rated Value (□: packaging code)

Part Number		Inductance	Inductance Test Frequency	Rated Current	DC Resistance	Self-Resonance Frequency (min.)
For Infotainment	For Powertrain/Safety					
LQM2HPZR56ME0□	—	0.56μH ±20%	1MHz	1500mA	0.06Ω ±25%	70MHz

Class of Magnetic Shield: Magnetic shield of ferrite Operating Temperature Range: -55°C~+125°C

■ Inductance-Frequency Characteristics (Typ.)

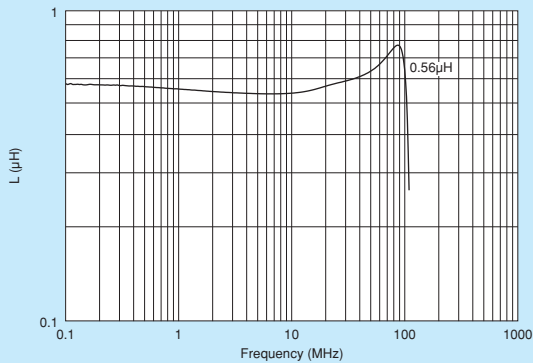

■ Inductance-Current Characteristics (Typ.)

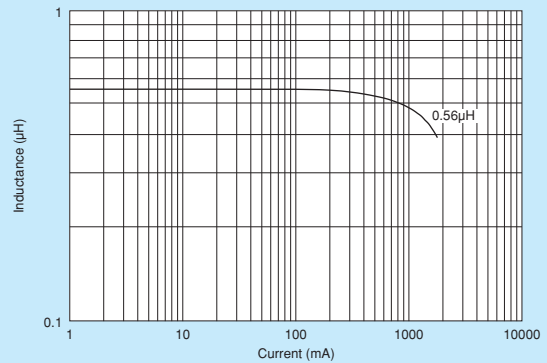

■ Temperature Rise Characteristics (Typ.)

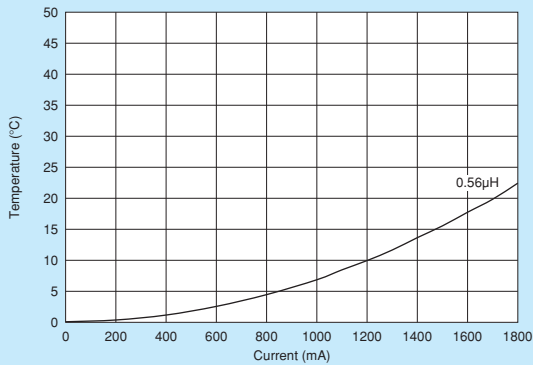

△Note • Please read rating and △CAUTION (for storage, operating, rating, soldering, mounting and handling) in this catalog to prevent smoking and/or burning, etc.
• This catalog has only typical specifications. Therefore, please approve our product specifications or transact the approval sheet for product specifications before ordering.

Wire Wound Type (Ferrite Core)

LQH3NPZ_JR Series 1212/3030 (inch/mm)

Low DC Resistance Type, 1.2mm max. Thickness

■ Appearance/Dimensions

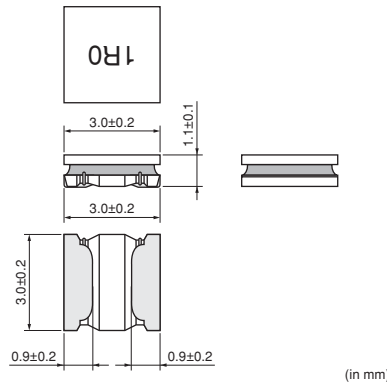

■ Packaging

Code	Packaging	Minimum Quantity
L	ø180mm Embossed Taping	2000

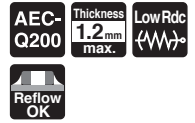

Refer to pages from p.191 to p.194 for mounting information.

■ Rated Value (□: packaging code)

Part Number		Inductance	Rated Current ^{*1} (Based on Inductance Change)	Rated Current (Based on Temperature Rise) ^{*2}		DC Resistance	Self-Resonance Frequency (min.)
For Infotainment	For Powertrain/Safety			Ambient Temperature 85°C ^{*3}	Ambient Temperature 105°C ^{*4}		
LQH3NPZR68NJR□	—	0.68μH ±30%	2700mA	2860mA	1280mA	0.032Ω ±20%	130MHz
LQH3NPZ1R0MJR□	—	1.0μH ±20%	2250mA	2780mA	1230mA	0.040Ω ±20%	100MHz
LQH3NPZ1R5MJR□	—	1.5μH ±20%	1950mA	2510mA	1100mA	0.049Ω ±20%	60MHz
LQH3NPZ2R2MJR□	—	2.2μH ±20%	1800mA	2200mA	980mA	0.068Ω ±20%	45MHz
LQH3NPZ3R3MJR□	—	3.3μH ±20%	1350mA	1700mA	750mA	0.095Ω ±20%	45MHz
LQH3NPZ4R7MJR□	—	4.7μH ±20%	1180mA	1580mA	710mA	0.12Ω ±20%	40MHz
LQH3NPZ6R8MJR□	—	6.8μH ±20%	970mA	1360mA	610mA	0.18Ω ±20%	35MHz
LQH3NPZ100MJR□	—	10μH ±20%	810mA	1200mA	530mA	0.24Ω ±20%	30MHz
LQH3NPZ150MJR□	—	15μH ±20%	650mA	870mA	370mA	0.38Ω ±20%	25MHz
LQH3NPZ220MJR□	—	22μH ±20%	520mA	800mA	350mA	0.50Ω ±20%	20MHz
LQH3NPZ330MJR□	—	33μH ±20%	420mA	630mA	280mA	0.79Ω ±20%	15MHz
LQH3NPZ470MJR□	—	47μH ±20%	360mA	570mA	240mA	1.0Ω ±20%	10MHz

Inductance Test Frequency: 1MHz Class of Magnetic Shield: Magnetic shield of magnetic powder in resin

Operating Temperature Range (Self-temperature rise is included): -40°C~+125°C

Operating Temperature Range (Self-temperature rise is not included): -40°C~+105°C

For reflow soldering only.

*1 When applied rated current to the products, inductance will be within ±30% of initial inductance value range.

*2 Keep the temperature (ambient temperature plus self-generation of heat) under 125°C.

*3 When applied rated current to the products, temperature rise caused by self-generated heat shall be limited to 40°C max. (Ambient temperature 85°C).

*4 When applied rated current to the products, temperature rise caused by self-generated heat shall be limited to 20°C max. (Ambient temperature 85°C to 105°C)

■ Inductance-Frequency Characteristics (Typ.)

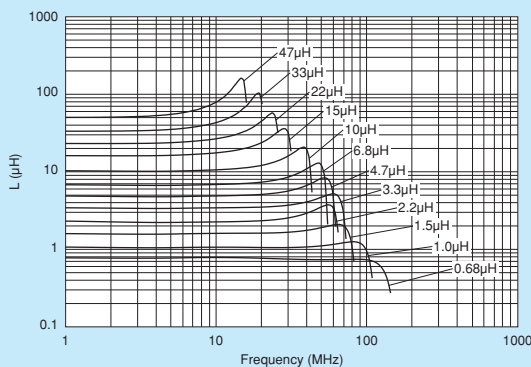

■ Inductance-Current Characteristics (Typ.)

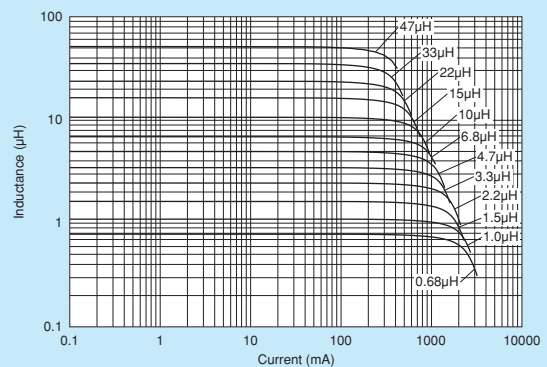

Continued on the following page.

△Note • Please read rating and △CAUTION (for storage, operating, rating, soldering, mounting and handling) in this catalog to prevent smoking and/or burning, etc.
• This catalog has only typical specifications. Therefore, please approve our product specifications or transact the approval sheet for product specifications before ordering.

■ Temperature Rise Characteristics (Typ.)

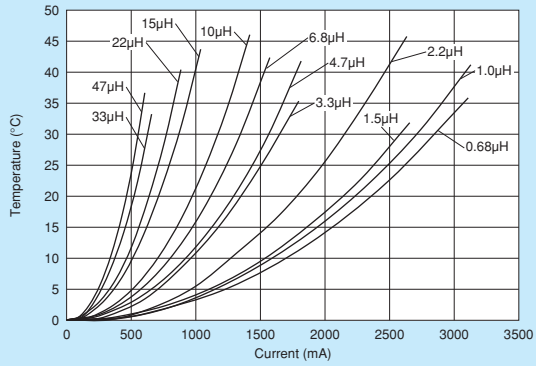

⚠Note • Please read rating and ⚠CAUTION (for storage, operating, rating, soldering, mounting and handling) in this catalog to prevent smoking and/or burning, etc.
• This catalog has only typical specifications. Therefore, please approve our product specifications or transact the approval sheet for product specifications before ordering.

Wire Wound Type (Ferrite Core)

LQH32PZ_N0 Series 1210/3225 (inch/mm)

1.7mm max. Thickness

■ Appearance/Dimensions

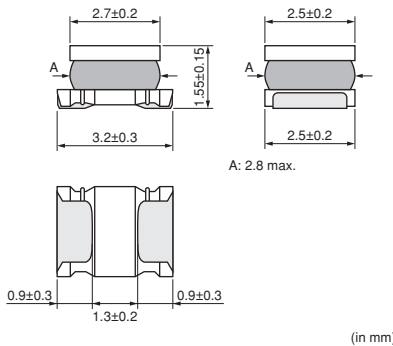

■ Packaging

Code	Packaging	Minimum Quantity
L	ø180mm Embossed Taping	2000
K	ø330mm Embossed Taping	7500



Refer to pages from p.191 to p.194 for mounting information.

■ Rated Value (□: packaging code)

Part Number		Inductance	Rated Current *1*3 (Based on Inductance Change)	Rated Current (Based on Temperature Rise) *2*3		DC Resistance	Self-Resonance Frequency (min.)
For Infotainment	For Powertrain/Safety			Ambient Temperature 85°C	Ambient Temperature 105°C		
LQH32PZR47NN0□	—	0.47µH ±30%	3400mA	2550mA	1600mA	0.030Ω ±20%	100MHz
LQH32PZ1R0NN0□	—	1.0µH ±30%	2300mA	2050mA	1320mA	0.045Ω ±20%	100MHz
LQH32PZ1R5NN0□	—	1.5µH ±30%	1750mA	1750mA	1010mA	0.057Ω ±20%	70MHz
LQH32PZ2R2NN0□	—	2.2µH ±30%	1550mA	1600mA	970mA	0.076Ω ±20%	70MHz
LQH32PZ3R3NN0□	—	3.3µH ±30%	1250mA	1200mA	670mA	0.12Ω ±20%	50MHz
LQH32PZ4R7NN0□	—	4.7µH ±30%	1000mA	1000mA	530mA	0.18Ω ±20%	40MHz
LQH32PZ6R8NN0□	—	6.8µH ±30%	850mA	850mA	510mA	0.24Ω ±20%	40MHz
LQH32PZ100MN0□	—	10µH ±20%	750mA	700mA	380mA	0.38Ω ±20%	30MHz
LQH32PZ150MN0□	—	15µH ±20%	600mA	520mA	320mA	0.57Ω ±20%	20MHz
LQH32PZ220MN0□	—	22µH ±20%	500mA	450mA	240mA	0.81Ω ±20%	20MHz
LQH32PZ330MN0□	—	33µH ±20%	380mA	390mA	190mA	1.15Ω ±20%	13MHz
LQH32PZ470MN0□	—	47µH ±20%	330mA	310mA	140mA	1.78Ω ±20%	11MHz
LQH32PZ680MN0□	—	68µH ±20%	280mA	275mA	120mA	2.28Ω ±20%	11MHz
LQH32PZ101MN0□	—	100µH ±20%	180mA	250mA	110mA	2.70Ω ±20%	8MHz
LQH32PZ121MN0□	—	120µH ±20%	170mA	200mA	80mA	4.38Ω ±20%	8MHz

Inductance Test Frequency: 1MHz Class of Magnetic Shield: Magnetic shield of magnetic powder in resin

Operating Temperature Range (Self-temperature rise is included): -40°C~+125°C

Operating Temperature Range (Self-temperature rise is not included): -40°C~+105°C

For reflow soldering only.

*1 When applied rated current to the products, inductance will be within ±30% of nominal inductance value.

*2 When applied rated current to the products, temperature rise caused by self-generated heat shall be limited to 40°C max.

*3 Keep the temperature (ambient temperature plus self-generation of heat) under 125°C.

Continued on the following page.

△Note • Please read rating and △CAUTION (for storage, operating, rating, soldering, mounting and handling) in this catalog to prevent smoking and/or burning, etc.
• This catalog has only typical specifications. Therefore, please approve our product specifications or transact the approval sheet for product specifications before ordering.

■ Inductance-Frequency Characteristics (Typ.)

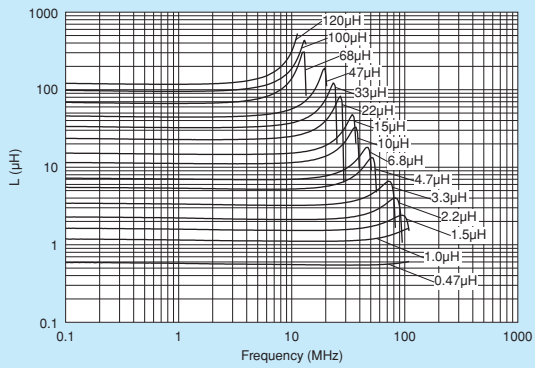

■ Inductance-Current Characteristics (Typ.)

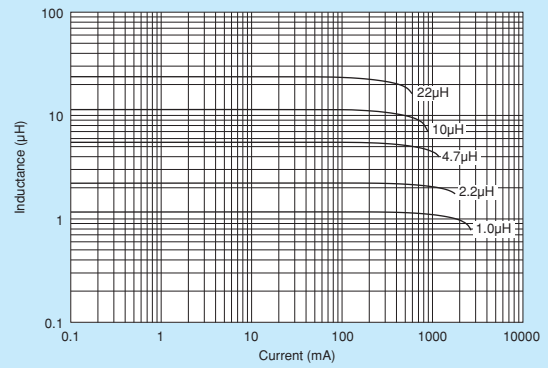

■ Temperature Rise Characteristics (Typ.)

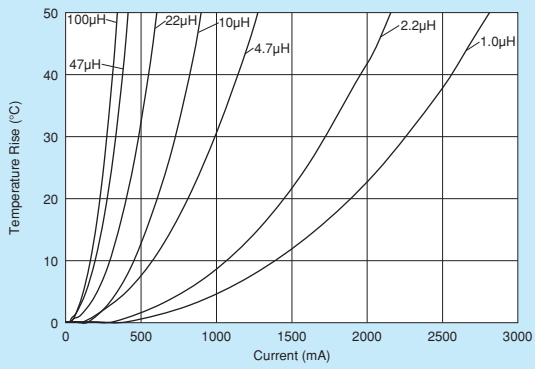

⚠Note • Please read rating and ⚠CAUTION (for storage, operating, rating, soldering, mounting and handling) in this catalog to prevent smoking and/or burning, etc.
• This catalog has only typical specifications. Therefore, please approve our product specifications or transact the approval sheet for product specifications before ordering.

Wire Wound Type (Ferrite Core)

LQH32PZ_NC Series 1210/3225 (inch/mm)

1.7mm max. Thickness, Bias Current Characteristics Improved

■ Appearance/Dimensions

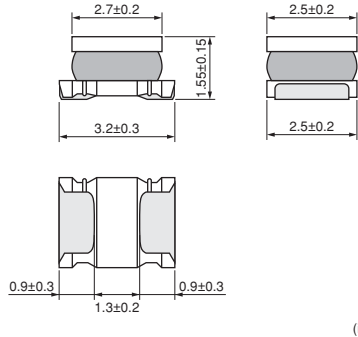

(in mm)

■ Packaging

Code	Packaging	Minimum Quantity
L	ø180mm Embossed Taping	2000
K	ø330mm Embossed Taping	7500

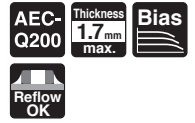

Refer to pages from p.191 to p.194 for mounting information.

■ Rated Value (□: packaging code)

Part Number		Inductance	Rated Current *1*3 (Based on Inductance Change)	Rated Current (Based on Temperature Rise) *2*3		DC Resistance	Self-Resonance Frequency (min.)
For Infotainment	For Powertrain/Safety			Ambient Temperature 85°C	Ambient Temperature 105°C		
LQH32PZR47NNC□	—	0.47µH ±30%	4400mA	2900mA	1490mA	0.024Ω ±20%	100MHz
LQH32PZ1R0NNC□	—	1.0µH ±30%	3000mA	2500mA	1380mA	0.036Ω ±20%	100MHz
LQH32PZ1R5NNC□	—	1.5µH ±30%	2600mA	2100mA	1110mA	0.053Ω ±20%	70MHz
LQH32PZ2R2NNC□	—	2.2µH ±30%	2000mA	1850mA	910mA	0.064Ω ±20%	70MHz
LQH32PZ3R3NNC□	—	3.3µH ±30%	1900mA	1550mA	800mA	0.100Ω ±20%	50MHz
LQH32PZ4R7NNC□	—	4.7µH ±30%	1600mA	1200mA	610mA	0.155Ω ±20%	40MHz
LQH32PZ6R8NNC□	—	6.8µH ±30%	1300mA	1100mA	550mA	0.220Ω ±20%	40MHz
LQH32PZ100MNC□	—	10µH ±20%	1000mA	900mA	450mA	0.295Ω ±20%	30MHz
LQH32PZ150MNC□	—	15µH ±20%	800mA	700mA	330mA	0.475Ω ±20%	20MHz
LQH32PZ220MNC□	—	22µH ±20%	650mA	550mA	270mA	0.685Ω ±20%	20MHz

Inductance Test Frequency: 1MHz Class of Magnetic Shield: Magnetic shield of magnetic powder in resin

Operating Temperature Range (Self-temperature rise is included): -40°C~+125°C

Operating Temperature Range (Self-temperature rise is not included): -40°C~+105°C

For reflow soldering only.

*1 When applied rated current to the products, inductance will be within ±30% of nominal inductance value.

*2 When applied rated current to the products, temperature rise caused by self-generated heat shall be limited to 40°C max.

*3 Keep the temperature (ambient temperature plus self-generation of heat) under 125°C.

■ Inductance-Frequency Characteristics (Typ.)

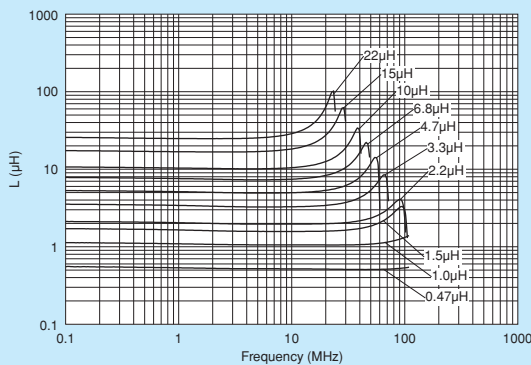

■ Inductance-Current Characteristics (Typ.)

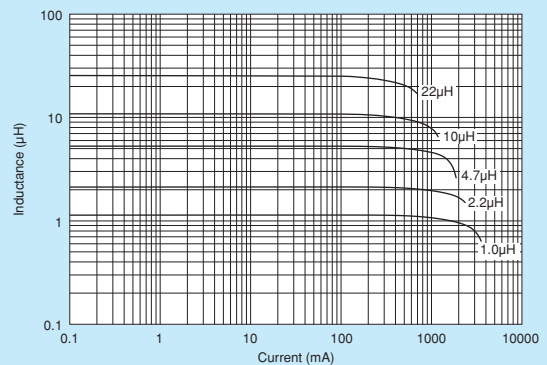

Continued on the following page.

△Note • Please read rating and △CAUTION (for storage, operating, rating, soldering, mounting and handling) in this catalog to prevent smoking and/or burning, etc.
• This catalog has only typical specifications. Therefore, please approve our product specifications or transact the approval sheet for product specifications before ordering.

■ Temperature Rise Characteristics (Typ.)

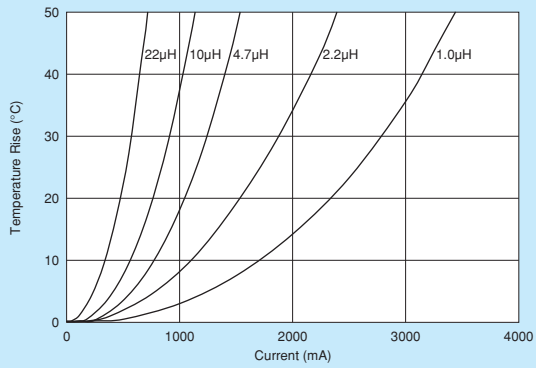

⚠Note • Please read rating and ⚠CAUTION (for storage, operating, rating, soldering, mounting and handling) in this catalog to prevent smoking and/or burning, etc.
• This catalog has only typical specifications. Therefore, please approve our product specifications or transact the approval sheet for product specifications before ordering.

Wire Wound Type (Ferrite Core)

LQH43PZ_26 Series 1812/4532 (inch/mm)

Size Code 1812 (4532) in inch (in mm)

■ Appearance/Dimensions

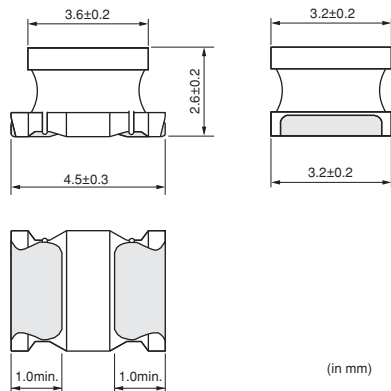

(in mm)

■ Packaging

Code	Packaging	Minimum Quantity
L	ø180mm Embossed Taping	500
K	ø330mm Embossed Taping	2500



Refer to pages from p.191 to p.194 for mounting information.

■ Rated Value (□: packaging code)

Part Number		Inductance	Rated Current *1,3 (Based on Inductance Change)	Rated Current (Based on Temperature Rise) *2,3		DC Resistance	Self-Resonance Frequency (min.)
For Infotainment	For Powertrain/Safety			Ambient Temperature 85°C	Ambient Temperature 105°C		
LQH43PZ1R0N26□	—	1.0μH ±30%	3400mA	3300mA	1410mA	0.026Ω ±20%	100MHz
LQH43PZ2R2M26□	—	2.2μH ±20%	2300mA	2500mA	1120mA	0.042Ω ±20%	45MHz
LQH43PZ3R3M26□	—	3.3μH ±20%	1800mA	2100mA	1000mA	0.052Ω ±20%	40MHz
LQH43PZ4R7M26□	—	4.7μH ±20%	1400mA	1600mA	780mA	0.075Ω ±20%	35MHz
LQH43PZ6R8M26□	—	6.8μH ±20%	1200mA	1400mA	760mA	0.098Ω ±20%	30MHz
LQH43PZ8R2M26□	—	8.2μH ±20%	1100mA	1300mA	670mA	0.128Ω ±20%	25MHz
LQH43PZ100M26□	—	10μH ±20%	1050mA	1170mA	620mA	0.147Ω ±20%	20MHz
LQH43PZ220M26□	—	22μH ±20%	700mA	780mA	400mA	0.327Ω ±20%	15MHz
LQH43PZ470M26□	—	47μH ±20%	470mA	520mA	280mA	0.718Ω ±20%	8MHz
LQH43PZ101M26□	—	100μH ±20%	320mA	320mA	180mA	1.538Ω ±20%	4MHz
LQH43PZ151M26□	—	150μH ±20%	280mA	260mA	140mA	2.362Ω ±20%	3MHz
LQH43PZ221M26□	—	220μH ±20%	220mA	240mA	130mA	2.900Ω ±20%	2MHz

Inductance Test Frequency: 1MHz Class of Magnetic Shield: Magnetic shield of magnetic powder in resin

Operating Temperature Range (Self-temperature rise is included): -40°C~+125°C

Operating Temperature Range (Self-temperature rise is not included): -40°C~+105°C

For reflow soldering only.

*1 When applied rated current to the products, inductance will be within ±30% of nominal inductance value.

*2 When applied rated current to the products, temperature rise caused by self-generated heat shall be limited to 40°C max.

*3 Keep the temperature (ambient temperature plus self-generation of heat) under 125°C.

■ Inductance-Frequency Characteristics (Typ.)

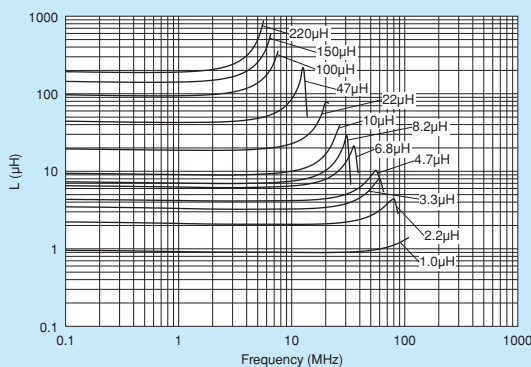

■ Inductance-Current Characteristics (Typ.)

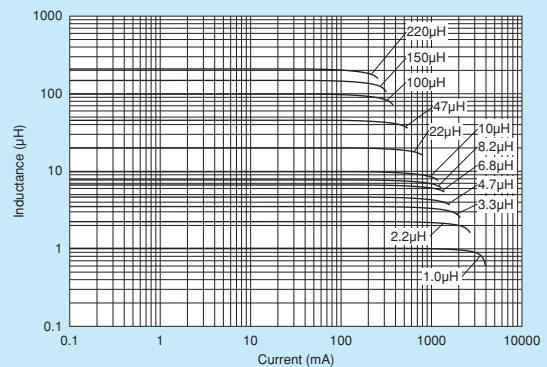

Continued on the following page.

△Note • Please read rating and △CAUTION (for storage, operating, rating, soldering, mounting and handling) in this catalog to prevent smoking and/or burning, etc.
• This catalog has only typical specifications. Therefore, please approve our product specifications or transact the approval sheet for product specifications before ordering.

■ Temperature Rise Characteristics (Typ.)

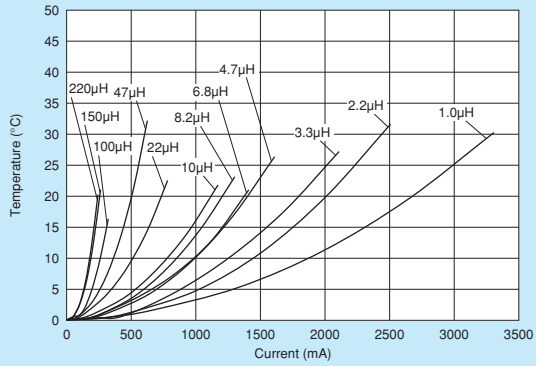

⚠Note • Please read rating and ⚠CAUTION (for storage, operating, rating, soldering, mounting and handling) in this catalog to prevent smoking and/or burning, etc.
• This catalog has only typical specifications. Therefore, please approve our product specifications or transact the approval sheet for product specifications before ordering.

Wire Wound Type (Ferrite Core)

LQH44PZ_GR Series 1515/4040 (inch/mm)

Size Code 4040 (1515) in mm (in inch), 1.0mm max. Thickness. Low DC Resistance

■ Appearance/Dimensions

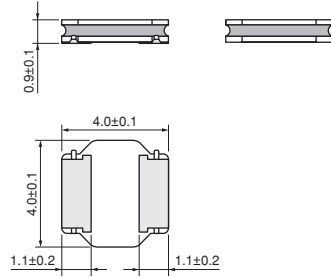

(in mm)

■ Packaging

Code	Packaging	Minimum Quantity
L	ø180mm Embossed Taping	1000
K	ø330mm Embossed Taping	4500

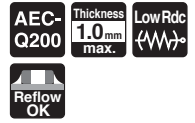

Refer to pages from p.191 to p.194 for mounting information.

■ Rated Value (□: packaging code)

Part Number		Inductance	Rated Current ^{*1} (Based on Inductance Change)	Rated Current (Based on Temperature Rise) ^{*2}		DC Resistance	Self-Resonance Frequency (min.)
For Infotainment	For Powertrain/Safety			Ambient Temperature 85°C ^{*3}	Ambient Temperature 105°C ^{*4}		
LQH44PZR68NGR□	—	0.68μH ±30%	2.4A	2.5A	1.5A	0.043Ω ±20%	54MHz
LQH44PZ1R0NGR□	—	1.0μH ±30%	2.0A	2.4A	1.4A	0.043Ω ±20%	50MHz
LQH44PZ2R2NGR□	—	2.2μH ±30%	1.6A	2.0A	1.2A	0.074Ω ±20%	45MHz
LQH44PZ3R3NGR□	—	3.3μH ±30%	1.5A	1.7A	1.0A	0.11Ω ±20%	25MHz
LQH44PZ4R7MGR□	—	4.7μH ±20%	1.2A	1.6A	0.96A	0.13Ω ±20%	17MHz
LQH44PZ6R8MGR□	—	6.8μH ±20%	0.85A	1.4A	0.84A	0.17Ω ±20%	15MHz
LQH44PZ100MGR□	—	10μH ±20%	0.80A	1.1A	0.66A	0.27Ω ±20%	13MHz
LQH44PZ150MGR□	—	15μH ±20%	0.64A	0.9A	0.54A	0.42Ω ±20%	10MHz
LQH44PZ220MGR□	—	22μH ±20%	0.50A	0.75A	0.45A	0.57Ω ±20%	8MHz
LQH44PZ330MGR□	—	33μH ±20%	0.40A	0.48A	0.28A	1.4Ω ±20%	6MHz
LQH44PZ470MGR□	—	47μH ±20%	0.36A	0.41A	0.24A	1.7Ω ±20%	6MHz

Inductance Test Frequency: 1MHz Class of Magnetic Shield: Magnetic shield of magnetic powder in resin

Operating Temperature Range (Self-temperature rise is included): -40°C~+125°C

Operating Temperature Range (Self-temperature rise is not included): -40°C~+105°C

For reflow soldering only.

*1 When applied rated current to the products, inductance will be within ±30% of initial inductance value range.

*2 Keep the temperature (ambient temperature plus self-generation of heat) under 125°C.

*3 When applied rated current to the products, temperature rise caused by self-generated heat shall be limited to 40°C max. (Ambient temperature 85°C).

*4 When applied rated current to the products, temperature rise caused by self-generated heat shall be limited to 20°C max. (Ambient temperature 85°C to 105°C).

■ Inductance-Frequency Characteristics (Typ.)

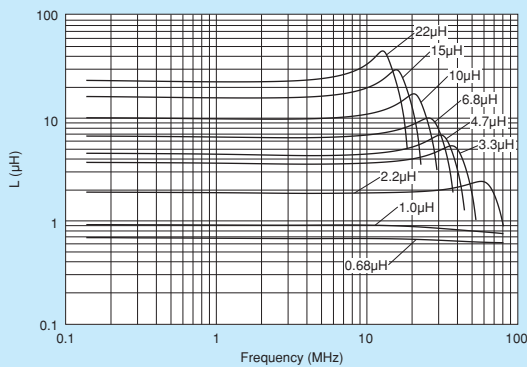

■ Inductance-Current Characteristics (Typ.)

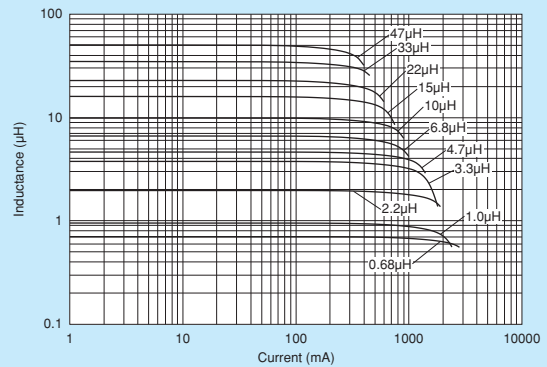

Continued on the following page.

△Note • Please read rating and △CAUTION (for storage, operating, rating, soldering, mounting and handling) in this catalog to prevent smoking and/or burning, etc.
• This catalog has only typical specifications. Therefore, please approve our product specifications or transact the approval sheet for product specifications before ordering.

■ Temperature Rise Characteristics (Typ.)

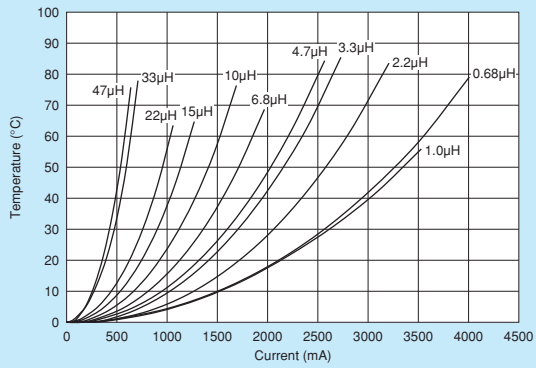

⚠Note • Please read rating and ⚠CAUTION (for storage, operating, rating, soldering, mounting and handling) in this catalog to prevent smoking and/or burning, etc.
• This catalog has only typical specifications. Therefore, please approve our product specifications or transact the approval sheet for product specifications before ordering.

LQH5BPZ_T0 Series 2020/5050 (inch/mm)

Size Code 2020 (5050) in inch (in mm)

■ Appearance/Dimensions

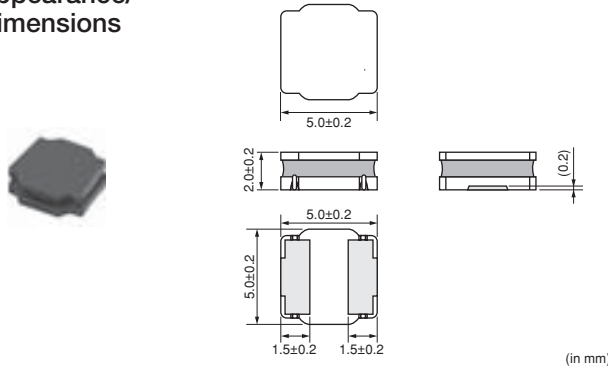

■ Packaging

Code	Packaging	Minimum Quantity
L	ø180mm Embossed Taping	500
K	ø330mm Embossed Taping	3000



Refer to pages from p.191 to p.194 for mounting information.

■ Rated Value (□: packaging code)

Part Number		Inductance	Rated Current *1*3 (Based on Inductance Change)	Rated Current (Based on Temperature Rise) *2*3		DC Resistance	Self-Resonance Frequency (min.)
For Infotainment	For Powertrain/Safety			Ambient Temperature 85°C	Ambient Temperature 105°C		
LQH5BPZR47NT0□	—	0.47µH ±30%	7.7A	4.0A	2.05A	0.012Ω ±20%	220MHz
LQH5BPZ1R0NT0□	—	1.0µH ±30%	5.8A	3.1A	1.68A	0.019Ω ±20%	90MHz
LQH5BPZ1R2NT0□	—	1.2µH ±30%	5.4A	3.1A	1.68A	0.019Ω ±20%	90MHz
LQH5BPZ1R5NT0□	—	1.5µH ±30%	5.0A	3.0A	1.63A	0.024Ω ±20%	70MHz
LQH5BPZ2R2NT0□	—	2.2µH ±30%	4.0A	2.6A	1.37A	0.030Ω ±20%	55MHz
LQH5BPZ2R7NT0□	—	2.7µH ±30%	3.8A	2.5A	1.23A	0.035Ω ±20%	50MHz
LQH5BPZ3R3NT0□	—	3.3µH ±30%	3.5A	2.3A	1.21A	0.044Ω ±20%	40MHz
LQH5BPZ4R7NT0□	—	4.7µH ±30%	3.0A	2.0A	1.09A	0.058Ω ±20%	40MHz
LQH5BPZ6R8NT0□	—	6.8µH ±30%	2.5A	1.65A	0.96A	0.083Ω ±20%	30MHz
LQH5BPZ100MT0□	—	10µH ±20%	2.0A	1.60A	0.87A	0.106Ω ±20%	25MHz
LQH5BPZ150MT0□	—	15µH ±20%	1.6A	1.20A	0.62A	0.187Ω ±20%	18MHz
LQH5BPZ220MT0□	—	22µH ±20%	1.4A	1.05A	0.55A	0.259Ω ±20%	15MHz

Inductance Test Frequency: 100kHz Class of Magnetic Shield: Magnetic shield of magnetic powder in resin

Operating Temperature Range (Self-temperature rise is included): -40°C~+125°C

Operating Temperature Range (Self-temperature rise is not included): -40°C~+105°C

For reflow soldering only.

*1 When applied rated current to the products, inductance will be within ±30% of nominal inductance value.

*2 When applied rated current to the products, temperature rise caused by self-generated heat shall be limited to 40°C max.

*3 Keep the temperature (ambient temperature plus self-generation of heat) under 125°C.

■ Inductance-Frequency Characteristics (Typ.)

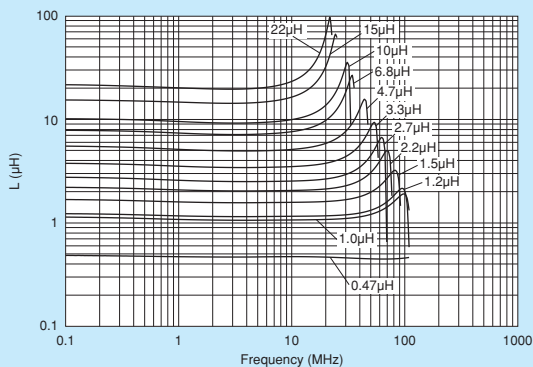

■ Inductance-Current Characteristics (Typ.)

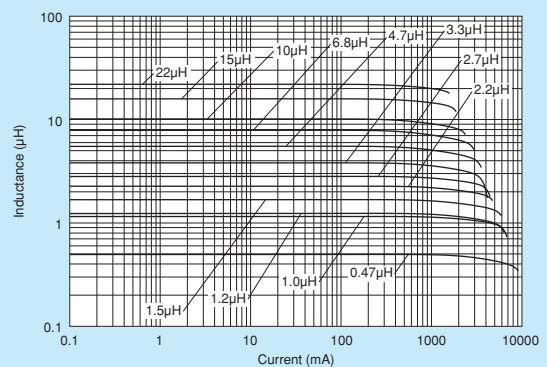

Continued on the following page.

△Note • Please read rating and △CAUTION (for storage, operating, rating, soldering, mounting and handling) in this catalog to prevent smoking and/or burning, etc.
• This catalog has only typical specifications. Therefore, please approve our product specifications or transact the approval sheet for product specifications before ordering.

■ Temperature Rise Characteristics (Typ.)

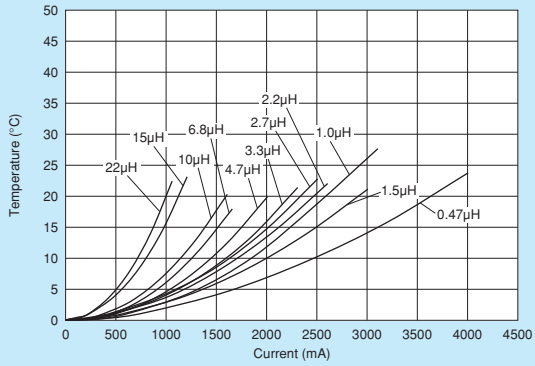

Continued on the following page.

⚠Note • Please read rating and ⚠CAUTION (for storage, operating, rating, soldering, mounting and handling) in this catalog to prevent smoking and/or burning, etc.
• This catalog has only typical specifications. Therefore, please approve our product specifications or transact the approval sheet for product specifications before ordering.

Wire Wound Type (Ferrite Core)

LQH2HPZ_JR Series 1008/2520 (inch/mm)

Size Code 1008 (2520) in inch (in mm), 1.2mm max. Thickness. Low DC Resistance

■ Appearance/Dimensions

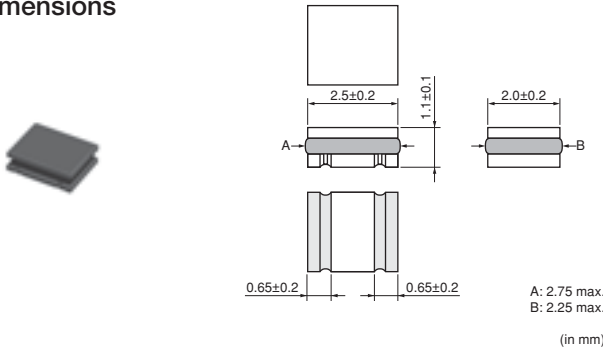

■ Packaging

Code	Packaging	Minimum Quantity
L	ø180mm Embossed Taping	2000

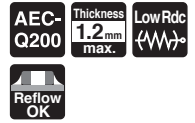

Refer to pages from p.191 to p.194 for mounting information.

■ Rated Value (□: packaging code)

Part Number		Inductance	Rated Current ^{*1} (Based on Inductance Change)	Rated Current (Based on Temperature Rise) ^{*2}		DC Resistance	Self-Resonance Frequency (min.)
For Infotainment	For Powertrain/Safety			Ambient Temperature 85°C ^{*3}	Ambient Temperature 105°C ^{*4}		
LQH2HPZR47NJR□	—	0.47μH ±30%	3.50A	2.75A	1.65A	0.031Ω ±20%	190MHz
LQH2HPZ1R0NJR□	—	1.0μH ±30%	2.60A	2.40A	1.44A	0.048Ω ±20%	120MHz
LQH2HPZ1R2NJR□	—	1.2μH ±30%	2.45A	2.07A	1.24A	0.055Ω ±20%	100MHz
LQH2HPZ1R5NJR□	—	1.5μH ±30%	2.20A	1.81A	1.08A	0.075Ω ±20%	95MHz
LQH2HPZ2R2MJR□	—	2.2μH ±20%	1.70A	1.65A	0.99A	0.092Ω ±20%	50MHz
LQH2HPZ3R3MJR□	—	3.3μH ±20%	1.45A	1.42A	0.85A	0.13Ω ±20%	45MHz
LQH2HPZ4R7MJR□	—	4.7μH ±20%	1.23A	1.29A	0.77A	0.17Ω ±20%	40MHz
LQH2HPZ6R8MJR□	—	6.8μH ±20%	1.05A	1.00A	0.60A	0.26Ω ±20%	35MHz
LQH2HPZ100MJR□	—	10μH ±20%	0.83A	0.83A	0.49A	0.38Ω ±20%	30MHz
LQH2HPZ150MJR□	—	15μH ±20%	0.69A	0.71A	0.42A	0.55Ω ±20%	20MHz
LQH2HPZ220MJR□	—	22μH ±20%	0.53A	0.54A	0.32A	0.84Ω ±20%	20MHz

Inductance Test Frequency: 1MHz Class of Magnetic Shield: Magnetic shield of magnetic powder in resin

Operating Temperature Range (Self-temperature rise is included): -40°C~+125°C

Operating Temperature Range (Self-temperature rise is not included): -40°C~+105°C

For reflow soldering only.

*1 When applied rated current to the products, inductance will be within ±30% of initial inductance value range.

*2 Keep the temperature (ambient temperature plus self-generation of heat) under 125°C.

*3 When applied rated current to the products, temperature rise caused by self-generated heat shall be limited to 40°C max. (Ambient temperature 85°C).

*4 When applied rated current to the products, temperature rise caused by self-generated heat shall be limited to 20°C max. (Ambient temperature 85°C to 105°C).

■ Inductance-Frequency Characteristics (Typ.)

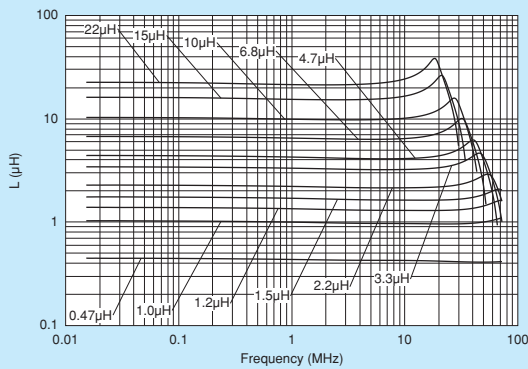

■ Inductance-Current Characteristics (Typ.)

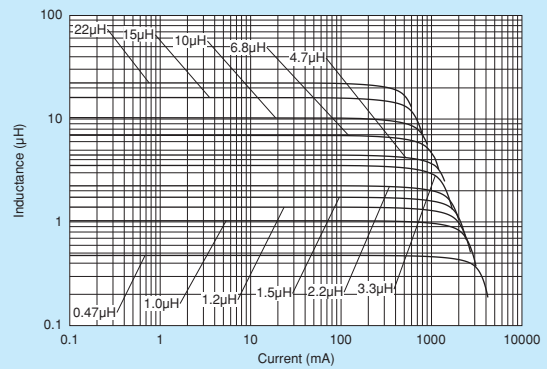

Continued on the following page.

△Note • Please read rating and △CAUTION (for storage, operating, rating, soldering, mounting and handling) in this catalog to prevent smoking and/or burning, etc.
• This catalog has only typical specifications. Therefore, please approve our product specifications or transact the approval sheet for product specifications before ordering.

■ Temperature Rise Characteristics (Typ.)

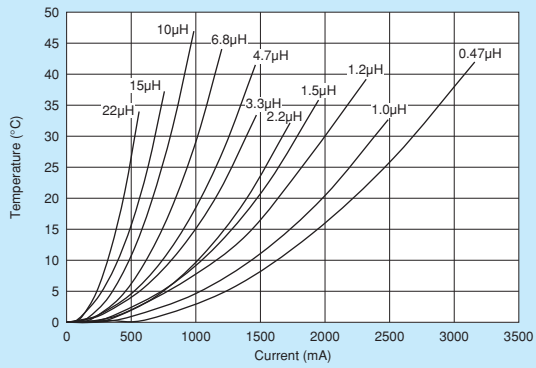

⚠Note • Please read rating and ⚠CAUTION (for storage, operating, rating, soldering, mounting and handling) in this catalog to prevent smoking and/or burning, etc.
• This catalog has only typical specifications. Therefore, please approve our product specifications or transact the approval sheet for product specifications before ordering.

Wire Wound Type (Ferrite Core)

LQH32DZ_23 Series 1210/3225 (inch/mm)

Size Code 1210 (3225) in inch (in mm)

■ Appearance/Dimensions

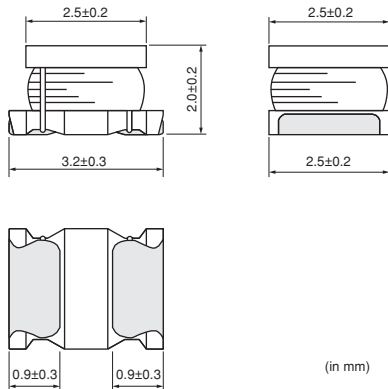

■ Packaging

Code	Packaging	Minimum Quantity
L	ø180mm Embossed Taping	2000
K	ø330mm Embossed Taping	7500



Refer to pages from p.191 to p.194 for mounting information.

■ Rated Value (□: packaging code)

Part Number		Inductance	Rated Current ^{*1} (Based on Inductance Change)	Rated Current ^{*1} (Based on Temperature Rise)	DC Resistance	Self-Resonance Frequency (min.)
For Infotainment	For Powertrain/Safety					
LQH32DZ1R0M23□	—	1.0μH ±20%	800mA	800mA	0.09Ω ±30%	96MHz
LQH32DZ2R2M23□	—	2.2μH ±20%	600mA	600mA	0.13Ω ±30%	64MHz
LQH32DZ3R3M23□	—	3.3μH ±20%	530mA	530mA	0.20Ω ±30%	50MHz
LQH32DZ4R7M23□	—	4.7μH ±20%	450mA	450mA	0.20Ω ±30%	43MHz
LQH32DZ100K23□	—	10μH ±10%	300mA	300mA	0.44Ω ±30%	26MHz
LQH32DZ220K23□	—	22μH ±10%	250mA	250mA	0.71Ω ±30%	19MHz
LQH32DZ390K23□	—	39μH ±10%	200mA	200mA	1.2Ω ±30%	16MHz
LQH32DZ470K23□	—	47μH ±10%	170mA	170mA	1.3Ω ±30%	15MHz
LQH32DZ680K23□	—	68μH ±10%	130mA	130mA	2.2Ω ±30%	12MHz
LQH32DZ101K23□	—	100μH ±10%	100mA	100mA	3.5Ω ±30%	10MHz
LQH32DZ151K23□	—	150μH ±10%	80mA	80mA	5.1Ω ±30%	8.0MHz
LQH32DZ221K23□	—	220μH ±10%	70mA	70mA	8.4Ω ±30%	6.8MHz
LQH32DZ331K23□	—	330μH ±10%	60mA	60mA	10.0Ω ±30%	5.6MHz

Inductance Test Frequency: 1MHz Class of Magnetic Shield: No magnetic shield

Operating Temperature Range: -40°C~+105°C

For reflow soldering only.

*1 When applied rated current to the products, self temperature rise shall be limited to 20°C max. and inductance will be within ±10% of initial inductance value.

■ Impedance-Frequency Characteristics (Typ.)

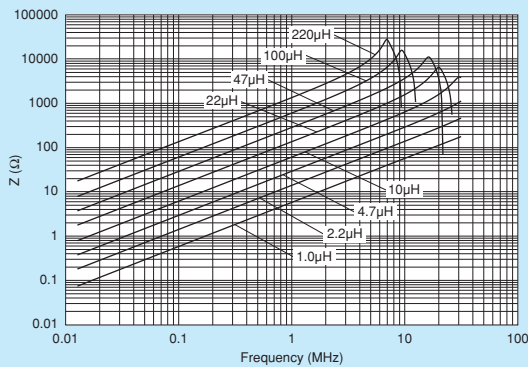

■ Inductance-Current Characteristics (Typ.)

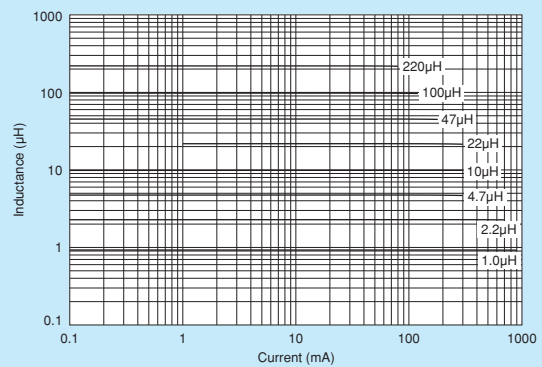

△Note • Please read rating and △CAUTION (for storage, operating, rating, soldering, mounting and handling) in this catalog to prevent smoking and/or burning, etc.
• This catalog has only typical specifications. Therefore, please approve our product specifications or transact the approval sheet for product specifications before ordering.

Wire Wound Type (Ferrite Core)

LQH32DZ_53 Series 1210/3225 (inch/mm)

Size Code 1210 (3225) in inch (in mm), 1.7mm max. Thickness.

■ Appearance/Dimensions

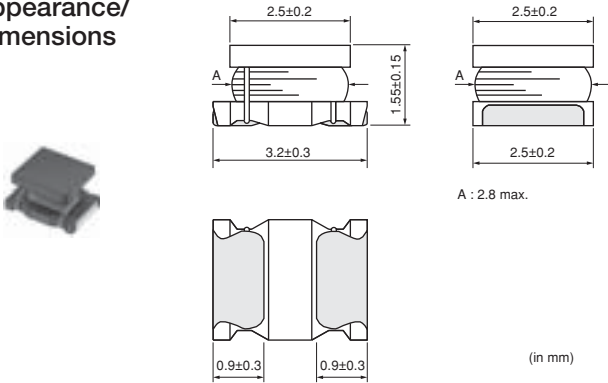

■ Packaging

Code	Packaging	Minimum Quantity
L	ø180mm Embossed Taping	2000
K	ø330mm Embossed Taping	7500



Refer to pages from p.191 to p.194 for mounting information.

■ Rated Value (□: packaging code)

Part Number		Inductance	Rated Current ^{*1} (Based on Inductance Change)	Rated Current ^{*1} (Based on Temperature Rise)	DC Resistance	Self-Resonance Frequency (min.)
For Infotainment	For Powertrain/Safety					
LQH32DZ1R0M53□	—	1.0μH ±20%	1000mA	1000mA	0.060Ω ±30%	100MHz
LQH32DZ2R2M53□	—	2.2μH ±20%	790mA	790mA	0.097Ω ±30%	64MHz
LQH32DZ3R3M53□	—	3.3μH ±20%	710mA	710mA	0.12Ω ±30%	50MHz
LQH32DZ4R7M53□	—	4.7μH ±20%	650mA	650mA	0.15Ω ±30%	43MHz
LQH32DZ6R8M53□	—	6.8μH ±20%	540mA	540mA	0.25Ω ±30%	32MHz
LQH32DZ100K53□	—	10μH ±10%	450mA	450mA	0.30Ω ±30%	26MHz
LQH32DZ150K53□	—	15μH ±10%	300mA	300mA	0.58Ω ±30%	26MHz
LQH32DZ220K53□	—	22μH ±10%	250mA	250mA	0.71Ω ±30%	19MHz
LQH32DZ330K53□	—	33μH ±10%	200mA	200mA	1.1Ω ±30%	17MHz
LQH32DZ470K53□	—	47μH ±10%	170mA	170mA	1.3Ω ±30%	15MHz
LQH32DZ680K53□	—	68μH ±10%	130mA	130mA	2.2Ω ±30%	12MHz
LQH32DZ101K53□	—	100μH ±10%	100mA	100mA	3.5Ω ±30%	10MHz

Inductance Test Frequency: 1MHz Class of Magnetic Shield: No magnetic shield
 Operating Temperature Range: -40°C~+105°C
 For reflow soldering only.

*1 When applied rated current to the products, self temperature rise shall be limited to 20°C max. and inductance will be within ±10% of initial inductance value.

■ Impedance-Frequency Characteristics (Typ.)

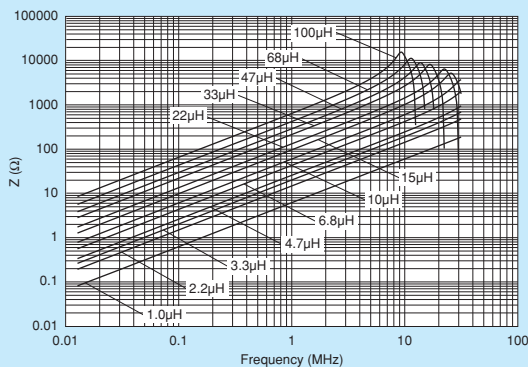

■ Inductance-Current Characteristics (Typ.)

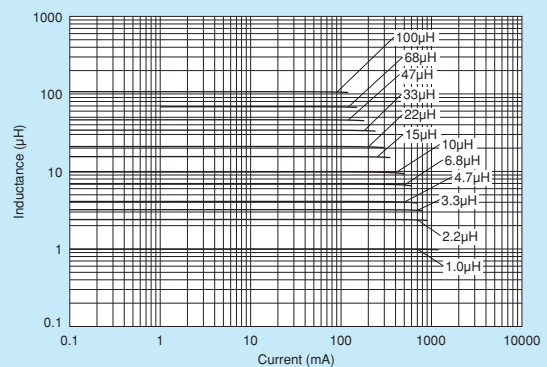

△Note • Please read rating and △CAUTION (for storage, operating, rating, soldering, mounting and handling) in this catalog to prevent smoking and/or burning, etc.
 • This catalog has only typical specifications. Therefore, please approve our product specifications or transact the approval sheet for product specifications before ordering.

Wire Wound Type (Ferrite Core)

LQH32CH_23/LQH32CH_33 Series 1210/3225 (inch/mm)

Size Code 1210 (3225) in inch (in mm)

■ Appearance/Dimensions

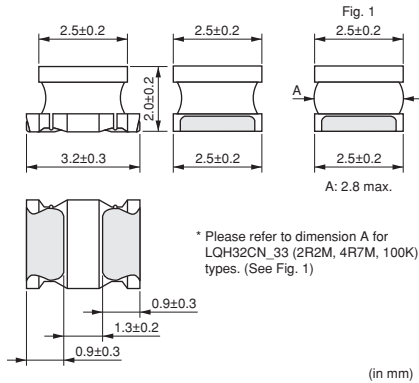

■ Packaging

Code	Packaging	Minimum Quantity
L	ø180mm Embossed Taping	2000
K	ø330mm Embossed Taping	7500

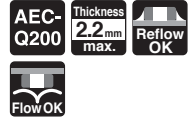

Refer to pages from p.191 to p.194 for mounting information.

■ Rated Value (□: packaging code)

Part Number		Inductance	Rated Current ^{*1} (Based on Inductance Change)	Rated Current ^{*1} (Based on Temperature Rise)	DC Resistance	Self-Resonance Frequency (min.)
For Infotainment	For Powertrain/Safety					
—	LQH32CH1R0M23□	1.0μH ±20%	800mA	800mA	0.09Ω ±30%	96MHz
—	LQH32CH2R2M23□	2.2μH ±20%	600mA	600mA	0.13Ω ±30%	64MHz
—	LQH32CH4R7M23□	4.7μH ±20%	450mA	450mA	0.20Ω ±30%	43MHz
—	LQH32CH100K23□	10μH ±10%	300mA	300mA	0.44Ω ±30%	26MHz
—	LQH32CH220K23□	22μH ±10%	250mA	250mA	0.71Ω ±30%	19MHz
—	LQH32CHR15M33□	0.15μH ±20%	1450mA	1450mA	0.028Ω ±30%	400MHz
—	LQH32CHR27M33□	0.27μH ±20%	1250mA	1250mA	0.034Ω ±30%	250MHz
—	LQH32CHR47M33□	0.47μH ±20%	1100mA	1100mA	0.042Ω ±30%	150MHz
—	LQH32CH1R0M33□	1.0μH ±20%	1000mA	1000mA	0.060Ω ±30%	100MHz
—	LQH32CH2R2M33□	2.2μH ±20%	790mA	790mA	0.097Ω ±30%	64MHz
—	LQH32CH4R7M33□	4.7μH ±20%	650mA	650mA	0.15Ω ±30%	43MHz
—	LQH32CH100K33□	10μH ±10%	450mA	450mA	0.30Ω ±30%	26MHz

Inductance Test Frequency: 1MHz Class of Magnetic Shield: No magnetic shield
Operating Temperature Range (Self-temperature rise is not included): -40°C~+85°C

*1 When applied rated current to the products, self temperature rise shall be limited to 20°C max. and inductance will be within ±10% of initial inductance value.

■ Impedance-Frequency Characteristics (Typ.)

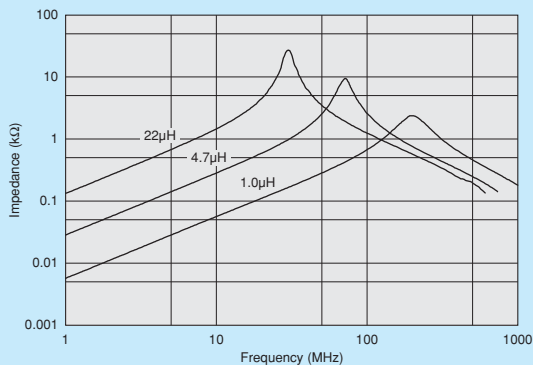

■ Inductance-Current Characteristics (Typ.)

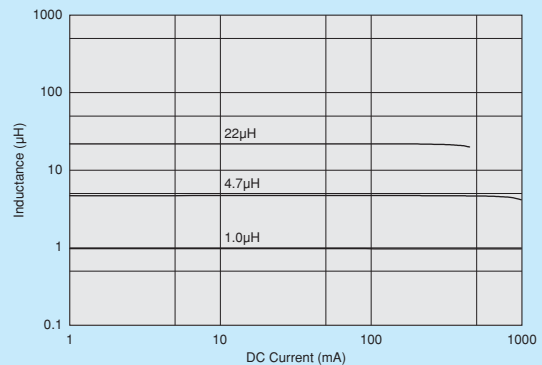

△Note • Please read rating and △CAUTION (for storage, operating, rating, soldering, mounting and handling) in this catalog to prevent smoking and/or burning, etc.
• This catalog has only typical specifications. Therefore, please approve our product specifications or transact the approval sheet for product specifications before ordering.

Wire Wound Type (Ferrite Core)

LQH32CH_53 Series 1210/3225 (inch/mm)

Size Code 1210 (3225) in inch (in mm), 1.7mm max. Thickness

■ Appearance/Dimensions

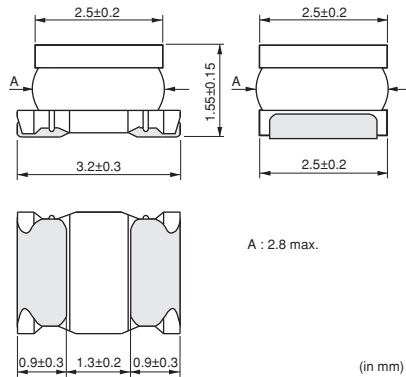

■ Packaging

Code	Packaging	Minimum Quantity
L	ø180mm Embossed Taping	2000
K	ø330mm Embossed Taping	7500

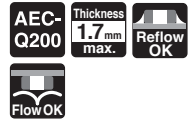

Refer to pages from p.191 to p.194 for mounting information.

■ Rated Value (□: packaging code)

Part Number		Inductance	Rated Current ^{*1} (Based on Inductance Change)	Rated Current ^{*1} (Based on Temperature Rise)	DC Resistance	Self-Resonance Frequency (min.)
For Infotainment	For Powertrain/Safety					
—	LQH32CH1R0M53□	1.0μH ±20%	1000mA	1000mA	0.060Ω ±30%	100MHz
—	LQH32CH2R2M53□	2.2μH ±20%	790mA	790mA	0.097Ω ±30%	64MHz
—	LQH32CH3R3M53□	3.3μH ±20%	710mA	710mA	0.12Ω ±30%	50MHz
—	LQH32CH4R7M53□	4.7μH ±20%	650mA	650mA	0.15Ω ±30%	43MHz
—	LQH32CH6R8M53□	6.8μH ±20%	540mA	540mA	0.25Ω ±30%	32MHz
—	LQH32CH100K53□	10μH ±10%	450mA	450mA	0.30Ω ±30%	26MHz
—	LQH32CH150K53□	15μH ±10%	300mA	300mA	0.58Ω ±30%	26MHz
—	LQH32CH220K53□	22μH ±10%	250mA	250mA	0.71Ω ±30%	19MHz

Inductance Test Frequency: 1MHz Class of Magnetic Shield: No magnetic shield
 Operating Temperature Range (Self-temperature rise is not included): -40°C~+85°C

*1 When applied rated current to the products, self temperature rise shall be limited to 20°C max. and inductance will be within ±10% of initial inductance value.

■ Impedance-Frequency Characteristics (Typ.)

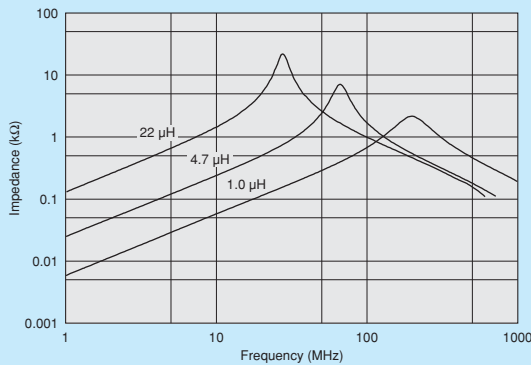

■ Inductance-Current Characteristics (Typ.)

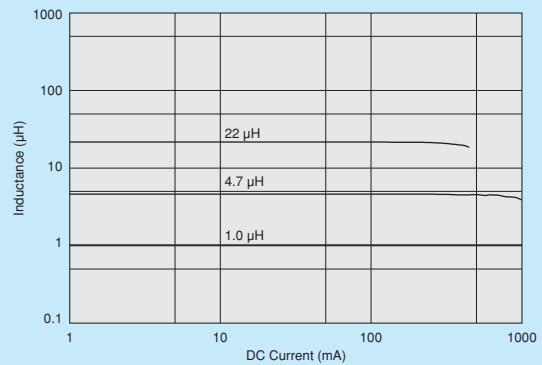

△Note • Please read rating and △CAUTION (for storage, operating, rating, soldering, mounting and handling) in this catalog to prevent smoking and/or burning, etc.
 • This catalog has only typical specifications. Therefore, please approve our product specifications or transact the approval sheet for product specifications before ordering.

⚠ Caution

● Rating

1. About the Rated Current

Do not use products beyond the rated current as this may create excessive heat and deteriorate the insulation resistance.

2. About Excessive Surge Current

Surge current (pulse current or rush current) greater than the specified rated current applied to the product may cause a critical failure, such as an open circuit, burnout caused by excessive temperature rise. Please contact us in advance in case of applying the surge current.

Notice

● Storage and Operating Condition

<Operating Environment>

Do not use products in chemical atmosphere such as chlorine gas, acid or sulfide gas.

<Storage Requirements>

1. Storage Period

LQM series should be used within 6 months; the other products should be used within 12 months. Check solderability if this period is exceeded.

2. Storage Conditions

(1) Store products in a warehouse in compliance with the following conditions:

Temperature: -10 to +40°C.

Humidity: 15 to 85% (relative humidity)

Do not subject products to rapid changes in temperature and humidity.

Do not store them in chemical atmosphere such as one containing sulfurous acid gas or alkaline gas.

This will prevent electrode oxidation, which causes poor solderability and possible corrosion of inductors.

(2) Do not store products in bulk packaging to prevent collision among inductors, which causes core chipping and wire breakage.

(3) Store products on pallets to protect from humidity, dust, etc.

(4) Avoid heat shock, vibration, direct sunlight, etc.

● Handling

This item is designed to have sufficient strength, but handle with care to avoid chipping or breaking its ceramic structure.

LQH_C/D/P series

- To prevent breaking the wire, avoid touching with sharp material, such as tweezers or the bristles of a cleaning brush, to the wire wound portion of this product.
- To prevent breaking the core, avoid applying excessive mechanical shock to products mounted on the board.
- Temperature may rise up to max. 40°C when applying the rated current to Inductors for Power Lines. Be careful of the temperature rating of the circuit board and components around the chip Inductors.

LQM series

- There is the possibility that magnetism may change the inductance value. Do not use a magnet or tweezers with magnetism when handling chip inductors. (The tip of the tweezers should be molded with resin or pottery.)
- When the excessive current over rated current is applied, it may cause the inductance value to change due to magnetism.

<Handling>

1. Avoid applying excessive stress to products to prevent damage.
2. Do not touch wire wound with sharp objects such as tweezers to prevent wire breakage.
3. Do not apply excessive force to products mounted on boards to prevent core breakage.

<Transportation>

Do not apply excessive vibration or mechanical shock to products.

<Resin Coating>

When coating products with resin, the relatively high resin curing stress may change inductance values. For exterior coating, select resin carefully so that electrical and mechanical performance of the product is not affected. Prior to use, please evaluate reliability with the product mounted in your application set. (LQH series)

An open circuit issue may occur by mechanical stress caused by the resin, amount/cured shape of resin, or operating conditions, etc. Some resins containing impurities or chloride may possibly generate chlorine by hydrolysis under some operating conditions, causing corrosion of the inductor wire and leading to an open circuit.

<Rated Current>

(LQH2HP_JR Series·LQH44P_GR Series)

Inductance will be more than the value, which is 30% down from minimum rated Inductance value.

(Other LQH_P Series)

Inductance will be within ±30% of nominal Inductance value.

• Based on Temperature Rise

For LQH_P series, rated current is set to keep temperature rise caused by self heating 40°C or less. For other Inductors for Power Lines, please refer to individual specifications.

Continued on the following page. ↗

⚠ Note • Please read rating and ⚠ CAUTION (for storage, operating, rating, soldering, mounting and handling) in this catalog to prevent smoking and/or burning, etc.
• This catalog has only typical specifications. Therefore, please approve our product specifications or transact the approval sheet for product specifications before ordering.

<Handling of a Substrate>

After mounting products on a substrate, do not apply any stress to the product caused by bending or twisting the substrate when cropping the substrate, inserting and removing a connector from the substrate, or tightening a screw to the substrate.

Excessive mechanical stress may cause cracking in the Product.

Bending

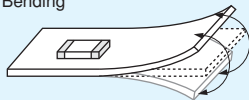

Twisting

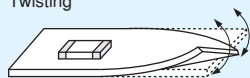

1. Standard Land Pattern Dimensions

A high Q value is achieved when the PCB electrode land pattern is designed so that it does not project beyond the chip Inductors (chip coils) electrode.

Land Pattern + Solder Resist
 Land Pattern
 Solder Resist
 (in mm)

Series	Standard Land Dimensions	Standard Land Dimensions			
		Part Number	a	b	c
LQM21P LQM2MP LQM2HP LQH32P LQH44P_GR LQH5BP		LQM21P	1.2	3.0-4.0	1.0
		LQM2MP	0.8	2.4	1.8
		LQM2HP	1.6	3.0	1.5
		LQH32P	1.3	3.8	2.0
		LQH44P_GR	1.5	4.4	2.7
		LQH5BP	1.8	5.5	4.1
LQH2HP					
LQH32C LQH32D					
LQH3NP_JR					
LQH43P					

Attention should be paid to potential magnetic coupling effects when using the Inductors (coils) as a resonator.

2. Standard Soldering Conditions

(1) Soldering method

Chip Inductors (Chip coils) can be flow or reflow soldered. Please contact Murata regarding other soldering methods. As for LQH2HP/3NP/32P/44P/5BP series, please use reflow soldering.

Solder: Use Sn-3.0Ag-0.5Cu solder.

Flux: Use rosin-based flux, but not strongly acidic flux (with chlorine content exceeding 0.2wt%).

Do not use water-soluble flux.

For additional mounting methods, please contact Murata.

Continued on the following page.

⚠Note • Please read rating and ⚠CAUTION (for storage, operating, rating, soldering, mounting and handling) in this catalog to prevent smoking and/or burning, etc.
 • This catalog has only typical specifications. Therefore, please approve our product specifications or transact the approval sheet for product specifications before ordering.

(2) Soldering profile

- Flow Soldering profile (Sn-3.0Ag-0.5Cu solder)

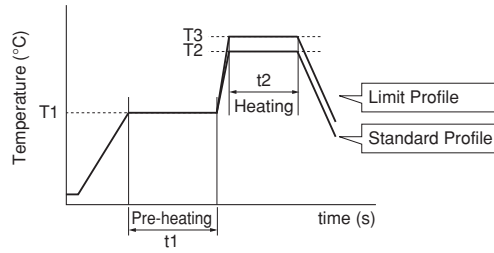

Series	Pre-heating		Standard Profile			Limit Profile		
	Temp. (T1)	Time. (t1)	Heating		Cycle of flow	Heating		Cycle of flow
			Temp. (T2)	Time. (t2)		Temp. (T3)	Time. (t2)	
LQM21P/2MP/2HP	150°C	60s min.	250°C	4 to 6s	2 times max.	265±3°C	5s max.	2 times max.
LQH32C LQH43P	150°C	60s min.	250°C	4 to 6s	2 times max.	265±3°C	5s max.	1 time

- Reflow Soldering profile (Sn-3.0Ag-0.5Cu solder)

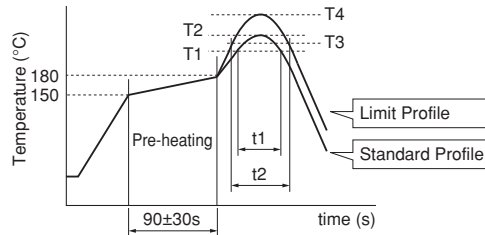

Series	Standard Profile				Limit Profile			
	Heating		Peak temperature (T2)	Cycle of reflow	Heating		Peak temperature (T4)	Cycle of reflow
	Temp. (T1)	Time. (t1)			Temp. (T3)	Time. (t2)		
LQM21P/2MP/2HP LQH2HP LQH32D LQH3NP/32P/43P/44P/5BP	220°C	30 to 60s	245±3°C	2 times max.	230°C	60s max.	260°C/10s	2 times max.
LQH32C	220°C	30 to 60s	245±3°C	2 times max.	230°C	60s max.	260°C/10s	1 time

(3) Reworking with Soldering Iron

Preheating at 150°C for 1 minute is required. Do not directly touch the ceramic element with the tip of the soldering iron. The reworking soldering conditions are as follows:

Soldering iron power output: 80W max.
 Temperature of soldering iron tip: 350°C
 Diameter of soldering iron end: 3.0mm max.
 Soldering time: within 3 s

Continued on the following page.

△Note • Please read rating and △CAUTION (for storage, operating, rating, soldering, mounting and handling) in this catalog to prevent smoking and/or burning, etc.
 • This catalog has only typical specifications. Therefore, please approve our product specifications or transact the approval sheet for product specifications before ordering.

3. Mounting Instructions

(1) Land Pattern Dimensions

Large lands reduce Q of the mounted chip. Also, large protruding land areas (bordered by lines having dimensions 'c' and 'd' shown) cause floating and electrode leaching.

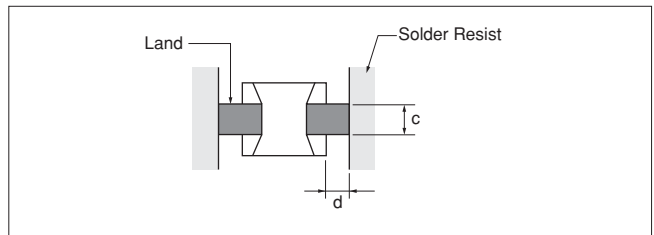

(2) Land Pattern Designing (LQH series)

Please follow the recommended patterns. Otherwise, their performance, which includes electrical performance or solderability, may be affected, or result in "position shift" in the soldering process.

(3) Magnetic Coupling

Since some chip inductors (chip coils) are constructed like an open magnetic circuit, narrow spacing between inductors (coils) may cause magnetic coupling. LQM and LQH_P series have a magnetically shielded structure. The structure makes their coupling coefficient smaller than that of conventional chip inductors (chip coils).

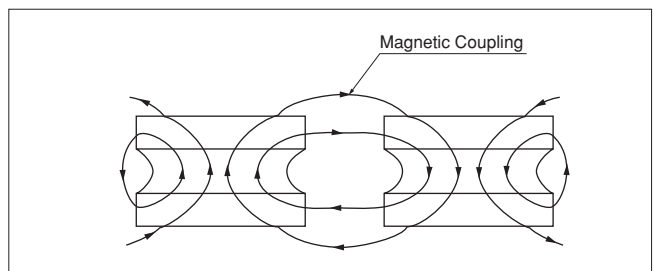

(4) PCB Warping

PCB should be designed so that products are not subjected to the mechanical stress caused by warping the board.

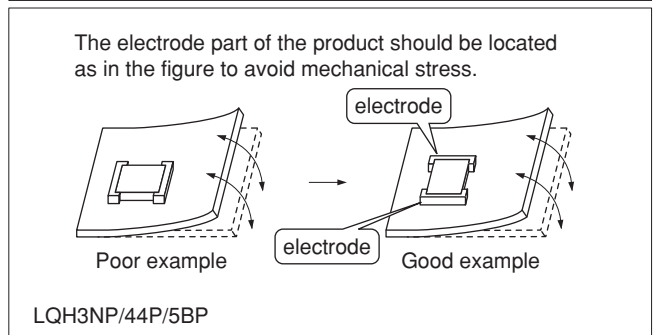
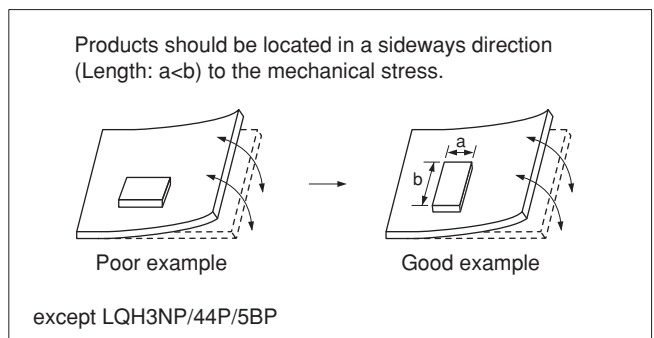

(5) Amount of Solder Paste

Excessive solder causes electrode corrosion, while insufficient solder causes low electrode bonding strength. Adjust the amount of solder paste as shown on the right so that solder is applied.

- Guideline of solder paste thickness
 - LQM, LQH2HP/3NP/32P/44P/5BP: 100 to 150 μ m
 - LQH32C/32D, LQH43P: 200 to 300 μ m

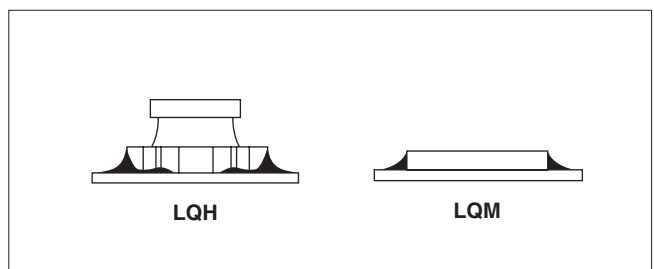

Continued on the following page.

⚠Note • Please read rating and ⚠CAUTION (for storage, operating, rating, soldering, mounting and handling) in this catalog to prevent smoking and/or burning, etc.
• This catalog has only typical specifications. Therefore, please approve our product specifications or transact the approval sheet for product specifications before ordering.

(6) Amount of Adhesive

If too much adhesive is applied, then it may overflow into the land or termination areas and yield poor solderability. In contrast, if insufficient adhesive is applied, or if the adhesive is not sufficiently hardened, then the chip may become detached during flow soldering. Apply the adhesive in accordance with the conditions shown in the chart.



Part Number	Typical Application Amount (in:mg)
	IR-100
LQM21P/2MP	0.20-0.25
LQM2HP	0.25-0.30
LQH32C	0.27-0.35

4. Cleaning

The following conditions should be observed when cleaning chip inductors (chip coils):

- (1) Cleaning Temperature: 60°C max. (40°C max. for alcohol cleaning agents)
- (2) Ultrasonic
 - Output: 20W/l max.
 - Duration: 5 minutes max.
 - Frequency: 28 to 40kHz
 - Care should be taken not to cause resonance of the PCB and mounted products.
- (3) Cleaning agent

The following cleaning agents have been tested on individual components. Evaluation in complete assembly should be done prior to production.

 - (a) Alcohol cleaning agents
 - Isopropyl alcohol (IPA)
 - (b) Aqueous cleaning agents
 - Pine Alpha ST-100S

- (4) Ensure that flux residue is completely removed. Component should be thoroughly dried after aqueous agents have been removed with deionized water.

For additional cleaning methods, please contact Murata.

⚠Note • Please read rating and ⚠CAUTION (for storage, operating, rating, soldering, mounting and handling) in this catalog to prevent smoking and/or burning, etc.
• This catalog has only typical specifications. Therefore, please approve our product specifications or transact the approval sheet for product specifications before ordering.

Minimum Quantity and 8mm Width Taping Dimensions

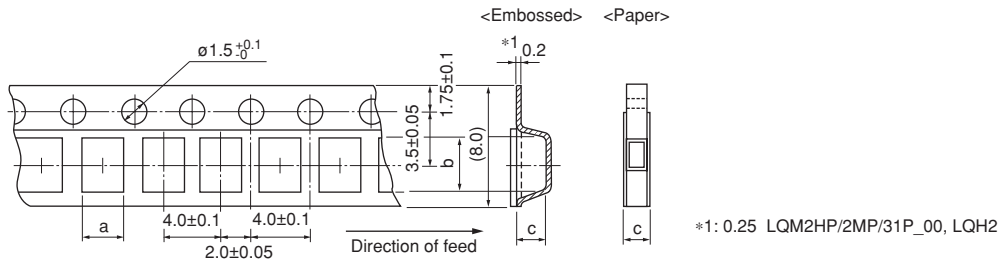

Dimension of the cavity of embossed tape is measured at the bottom side.

Paper Tape

Part Number	Dimensions		Total Thickness of Tape	Packaging Code (Minimum Qty. [pcs.])		
	a	b		$\phi 180\text{mm}$ reel	$\phi 330\text{mm}$ reel	Bulk
LQM21P_C0	1.45	2.25	0.8 max.	D [4000]	-	B [1000]
LQM21P_G	1.45	2.25	1.1 max.	D [4000]	-	B [1000]

Embossed Tape

Part Number	Dimensions		Depth of Cavity	Packaging Code (Minimum Qty. [pcs.])		
	a	b		$\phi 180\text{mm}$ reel	$\phi 330\text{mm}$ reel	Bulk
LQM2HP_J0/JC	2.25	2.75	1.3	L [3000]	-	B [1000]
LQM2HP_G	2.3	2.8	1.1	L [3000]	-	B [1000]
LQM2MP_G0	1.85	2.25	1.1	L [3000]	-	B [1000]
LQH32C_33/23, LQH32D_23/53	2.9	3.6	2.1	L [2000]	K [7500]	-
LQH32C_53	2.9	3.6	1.7	L [2000]	K [7500]	-
LQH32P	2.9	3.6	1.7	L [2000]	K [7500]	-

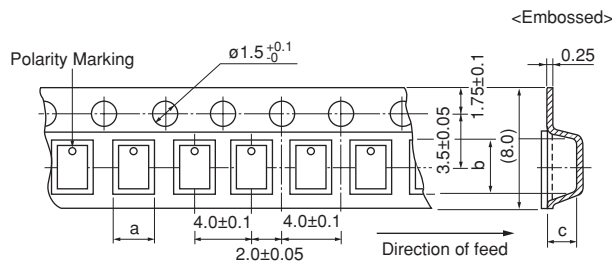

Dimension of the cavity of embossed tape is measured at the bottom side.

Embossed Tape

Part Number	Dimensions		Depth of Cavity	Packaging Code (Minimum Qty. [pcs.])		
	a	b		$\phi 180\text{mm}$ reel	$\phi 330\text{mm}$ reel	Bulk
LQH2HP_JR	2.3	2.8	1.3	L [2000]	-	-

(in mm)

Continued on the following page.

Note • Please read rating and **CAUTION** (for storage, operating, rating, soldering, mounting and handling) in this catalog to prevent smoking and/or burning, etc.
 • This catalog has only typical specifications. Therefore, please approve our product specifications or transact the approval sheet for product specifications before ordering.

■ Minimum Quantity and 8mm Width Taping Dimensions

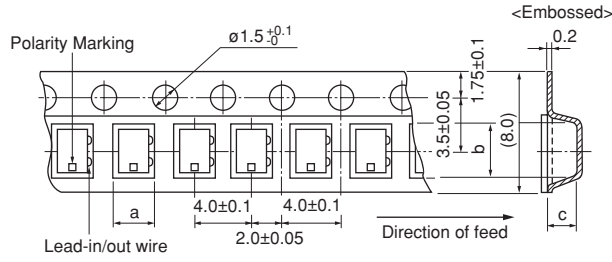

Dimension of the cavity of embossed tape is measured at the bottom side.

Embossed Tape

Part Number	Dimensions		Depth of Cavity	Packaging Code (Minimum Qty. [pcs.])		
	a	b		ø180mm reel	ø330mm reel	Bulk
LQH3NP_JR	3.3	3.3	1.6	L [2000]	-	-

(in mm)

■ Minimum Quantity and 12mm Width Embossed Taping Dimensions

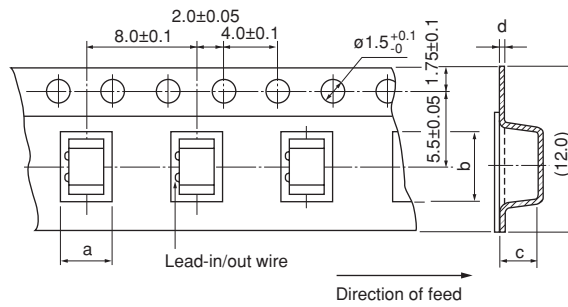

Dimension of the cavity of embossed tape is measured at the bottom side.

Embossed Tape

Part Number	Dimensions (c: Depth of Cavity)				Packaging Code (Minimum Qty. [pcs.])		
	a	b	c	d	ø180mm reel	ø330mm reel	Bulk
LQH43P	3.6	4.9	2.7	0.3	L [500]	K [2500]	-
LQH44P_GR	4.3	4.3	1.4	0.3	L [1000]	K [4500]	-
LQH5BP	5.3	5.3	2.4	0.3	L [500]	K [3000]	-

(in mm)

△Note • Please read rating and △CAUTION (for storage, operating, rating, soldering, mounting and handling) in this catalog to prevent smoking and/or burning, etc.
 • This catalog has only typical specifications. Therefore, please approve our product specifications or transact the approval sheet for product specifications before ordering.



Inductors for General Circuits **Part Numbering**

(Part Number) **LQ H 43 N Z 4R7 M 0 3 L**
 ① ② ③ ④ ⑤ ⑥ ⑦ ⑧ ⑨ ⑩

① Product ID

Product ID	
LQ	Chip Inductors (Chip Coils)

② Structure

Code	Structure
H	Wire Wound Type (Ferrite Core)

③ Dimensions (L×W)

Code	Dimensions (L×W)	Size Code (in inch)
31	3.2×1.6mm	1206
43	4.5×3.2mm	1812

④ Applications and Characteristics

Code	Applications and Characteristics
N	for Resonant Circuit
H	for High-frequency Resonant Circuit

⑤ Category

Code	Category	
Z	Automotive	Infotainment

⑥ Inductance

Expressed by three-digit alphanumerics. The unit is micro-henry (μH). The first and second figures are significant digits, and the third figure expresses the number of zeros that follow the two figures. If there is a decimal point, it is expressed by the capital letter "R". In this case, all figures are significant digits. If inductance is less than $0.1\mu\text{H}$, the inductance code is expressed by a combination of two figures and the capital letter "N", and the unit of inductance is nano-henry (nH).

The capital letter "N" indicates the unit of "nH", and also expresses a decimal point. In this case, all figures are significant digits.

⑦ Inductance Tolerance

Code	Inductance Tolerance
J	$\pm 5\%$
K	$\pm 10\%$
M	$\pm 20\%$

⑧ Features

Code	Features
0	Standard Type

⑨ Electrode

•Lead (Pb) Free

Code	Electrode
3	LF Solder

⑩ Packaging

Code	Packaging
K	Embossed Taping ($\phi 330\text{mm}$ Reel)
L	Embossed Taping ($\phi 180\text{mm}$ Reel)

\triangle Note • Please read rating and \triangle CAUTION (for storage, operating, rating, soldering, mounting and handling) in this catalog to prevent smoking and/or burning, etc.
 • This catalog has only typical specifications. Therefore, please approve our product specifications or transact the approval sheet for product specifications before ordering.

Wire Wound Type (Ferrite Core)

LQH31HZ_03 Series 1206/3216 (inch/mm)

Size Code 1206 (3216) in inch (in mm), Ferrite Core High Frequency Wound Type

■ Appearance/Dimensions

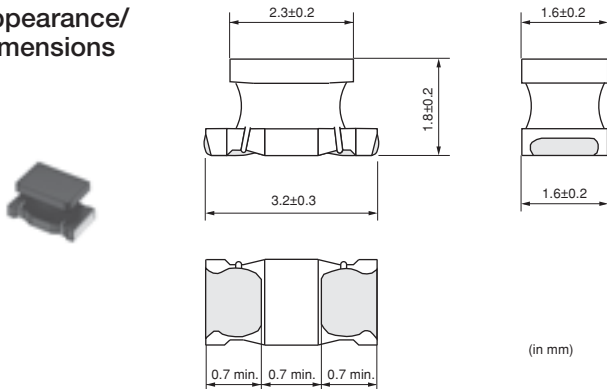

■ Packaging

Code	Packaging	Minimum Quantity
L	ø180mm Embossed Taping	2000
K	ø330mm Embossed Taping	7500

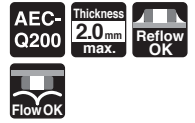

Refer to pages from p.203 to p.205 for mounting information.

■ Rated Value (□: packaging code)

Part Number		Inductance	Inductance Test Frequency	Rated Current	DC Resistance	Q (min.)	Q Test Frequency	Self-Resonance Frequency (min.)
For Infotainment	For Powertrain/Safety							
LQH31HZ54NK03□	—	54nH ±10%	1MHz	920mA	0.035Ω ±30%	50	100MHz	800MHz
LQH31HZ95NK03□	—	95nH ±10%	1MHz	790mA	0.047Ω ±30%	60	100MHz	650MHz
LQH31HZR14J03□	—	145nH ±5%	1MHz	700mA	0.061Ω ±30%	60	100MHz	500MHz
LQH31HZR14K03□	—	145nH ±10%	1MHz	700mA	0.061Ω ±30%	60	100MHz	500MHz
LQH31HZR21J03□	—	215nH ±5%	1MHz	520mA	0.11Ω ±30%	60	100MHz	430MHz
LQH31HZR21K03□	—	215nH ±10%	1MHz	520mA	0.11Ω ±30%	60	100MHz	430MHz
LQH31HZR29J03□	—	290nH ±5%	1MHz	420mA	0.17Ω ±30%	60	100MHz	360MHz
LQH31HZR29K03□	—	290nH ±10%	1MHz	420mA	0.17Ω ±30%	60	100MHz	360MHz
LQH31HZR39J03□	—	390nH ±5%	1MHz	330mA	0.26Ω ±30%	60	100MHz	300MHz
LQH31HZR39K03□	—	390nH ±10%	1MHz	330mA	0.26Ω ±30%	60	100MHz	300MHz
LQH31HZR50J03□	—	500nH ±5%	1MHz	260mA	0.44Ω ±30%	60	100MHz	270MHz
LQH31HZR50K03□	—	500nH ±10%	1MHz	260mA	0.44Ω ±30%	60	100MHz	270MHz
LQH31HZR61J03□	—	610nH ±5%	1MHz	250mA	0.48Ω ±30%	60	100MHz	240MHz
LQH31HZR61K03□	—	610nH ±10%	1MHz	250mA	0.48Ω ±30%	60	100MHz	240MHz
LQH31HZR75J03□	—	750nH ±5%	1MHz	190mA	0.79Ω ±30%	60	100MHz	220MHz
LQH31HZR75K03□	—	750nH ±10%	1MHz	190mA	0.79Ω ±30%	60	100MHz	220MHz
LQH31HZR88J03□	—	880nH ±5%	1MHz	180mA	0.86Ω ±30%	60	100MHz	200MHz
LQH31HZR88K03□	—	880nH ±10%	1MHz	180mA	0.86Ω ±30%	60	100MHz	200MHz

Operating Temperature Range (Self-temperature rise is not included): -40°C~+85°C

■ Q-Frequency Characteristics (Typ.)

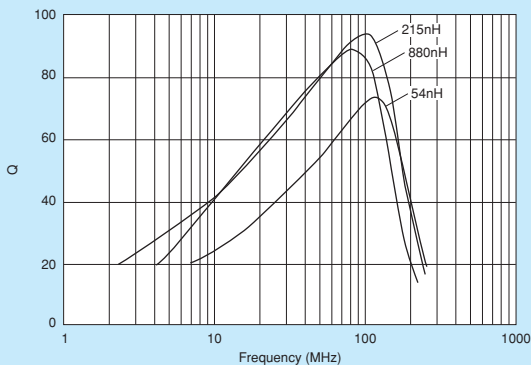

△Note • Please read rating and △CAUTION (for storage, operating, rating, soldering, mounting and handling) in this catalog to prevent smoking and/or burning, etc.
• This catalog has only typical specifications. Therefore, please approve our product specifications or transact the approval sheet for product specifications before ordering.

Inductors for Power Lines
Inductors for General Circuits
Wire Wound Type (Ferrite Core)
RF Inductors

Wire Wound Type (Ferrite Core)

LQH43NZ_03 Series 1812/4532 (inch/mm)

Size Code 1812 (4532) in inch (in mm)

■ Appearance/Dimensions

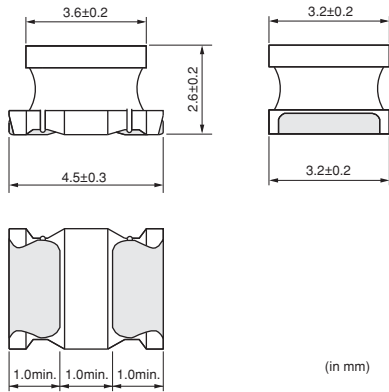

■ Packaging

Code	Packaging	Minimum Quantity
L	ø180mm Embossed Taping	500
K	ø330mm Embossed Taping	2500



Refer to pages from p.203 to p.205 for mounting information.

■ Rated Value (□: packaging code)

Part Number		Inductance	Inductance Test Frequency	Rated ^{*1} Current	Max. of DC Resistance	Q (min.)	Q Test Frequency	Self-Resonance Frequency (min.)
For Infotainment	For Powertrain/Safety							
LQH43NZ1R0M03□	—	1.0μH ±20%	1MHz	500mA	0.20Ω	20	1MHz	120MHz
LQH43NZ1R2M03□	—	1.2μH ±20%	1MHz	500mA	0.20Ω	20	1MHz	100MHz
LQH43NZ1R5M03□	—	1.5μH ±20%	1MHz	500mA	0.30Ω	20	1MHz	85MHz
LQH43NZ1R8M03□	—	1.8μH ±20%	1MHz	500mA	0.30Ω	20	1MHz	75MHz
LQH43NZ2R2M03□	—	2.2μH ±20%	1MHz	500mA	0.30Ω	20	1MHz	62MHz
LQH43NZ2R7M03□	—	2.7μH ±20%	1MHz	500mA	0.32Ω	20	1MHz	53MHz
LQH43NZ3R3M03□	—	3.3μH ±20%	1MHz	500mA	0.35Ω	20	1MHz	47MHz
LQH43NZ3R9M03□	—	3.9μH ±20%	1MHz	500mA	0.38Ω	20	1MHz	41MHz
LQH43NZ4R7K03□	—	4.7μH ±10%	1MHz	500mA	0.40Ω	30	1MHz	38MHz
LQH43NZ4R7M03□	—	4.7μH ±20%	1MHz	500mA	0.40Ω	30	1MHz	38MHz
LQH43NZ5R6K03□	—	5.6μH ±10%	1MHz	500mA	0.47Ω	30	1MHz	33MHz
LQH43NZ5R6M03□	—	5.6μH ±20%	1MHz	500mA	0.47Ω	30	1MHz	33MHz
LQH43NZ6R8K03□	—	6.8μH ±10%	1MHz	450mA	0.50Ω	30	1MHz	31MHz
LQH43NZ6R8M03□	—	6.8μH ±20%	1MHz	450mA	0.50Ω	30	1MHz	31MHz
LQH43NZ8R2K03□	—	8.2μH ±10%	1MHz	450mA	0.56Ω	30	1MHz	27MHz
LQH43NZ8R2M03□	—	8.2μH ±20%	1MHz	450mA	0.56Ω	30	1MHz	27MHz
LQH43NZ100J03□	—	10μH ±5%	1MHz	400mA	0.56Ω	35	1MHz	23MHz
LQH43NZ100K03□	—	10μH ±10%	1MHz	400mA	0.56Ω	35	1MHz	23MHz
LQH43NZ120J03□	—	12μH ±5%	1MHz	380mA	0.62Ω	35	1MHz	21MHz
LQH43NZ120K03□	—	12μH ±10%	1MHz	380mA	0.62Ω	35	1MHz	21MHz
LQH43NZ150J03□	—	15μH ±5%	1MHz	360mA	0.73Ω	35	1MHz	19MHz
LQH43NZ150K03□	—	15μH ±10%	1MHz	360mA	0.73Ω	35	1MHz	19MHz
LQH43NZ180J03□	—	18μH ±5%	1MHz	340mA	0.82Ω	35	1MHz	17MHz
LQH43NZ180K03□	—	18μH ±10%	1MHz	340mA	0.82Ω	35	1MHz	17MHz
LQH43NZ220J03□	—	22μH ±5%	1MHz	320mA	0.94Ω	35	1MHz	15MHz
LQH43NZ220K03□	—	22μH ±10%	1MHz	320mA	0.94Ω	35	1MHz	15MHz
LQH43NZ270J03□	—	27μH ±5%	1MHz	300mA	1.1Ω	35	1MHz	14MHz
LQH43NZ270K03□	—	27μH ±10%	1MHz	300mA	1.1Ω	35	1MHz	14MHz
LQH43NZ330J03□	—	33μH ±5%	1MHz	270mA	1.2Ω	35	1MHz	12MHz
LQH43NZ330K03□	—	33μH ±10%	1MHz	270mA	1.2Ω	35	1MHz	12MHz
LQH43NZ390J03□	—	39μH ±5%	1MHz	240mA	1.4Ω	35	1MHz	11MHz

Class of Magnetic Shield: No magnetic shield
 Operating Temperature Range: -40°C~+105°C
 For reflow soldering only.

*1 When applied rated current to the products, self temperature rise shall be limited to 20°C max. and inductance will be within ±10% of initial inductance value.

Continued on the following page.

△Note • Please read rating and △CAUTION (for storage, operating, rating, soldering, mounting and handling) in this catalog to prevent smoking and/or burning, etc.
 • This catalog has only typical specifications. Therefore, please approve our product specifications or transact the approval sheet for product specifications before ordering.

Part Number		Inductance	Inductance Test Frequency	Rated ^{*1} Current	Max. of DC Resistance	Q (min.)	Q Test Frequency	Self-Resonance Frequency (min.)
For Infotainment	For Powertrain/Safety							
LQH43NZ390K03□	—	39μH ±10%	1MHz	240mA	1.4Ω	35	1MHz	11MHz
LQH43NZ470J03□	—	47μH ±5%	1MHz	220mA	1.5Ω	35	1MHz	10MHz
LQH43NZ470K03□	—	47μH ±10%	1MHz	220mA	1.5Ω	35	1MHz	10MHz
LQH43NZ560J03□	—	56μH ±5%	1MHz	200mA	1.7Ω	35	1MHz	9.3MHz
LQH43NZ560K03□	—	56μH ±10%	1MHz	200mA	1.7Ω	35	1MHz	9.3MHz
LQH43NZ680J03□	—	68μH ±5%	1MHz	180mA	1.9Ω	35	1MHz	8.4MHz
LQH43NZ680K03□	—	68μH ±10%	1MHz	180mA	1.9Ω	35	1MHz	8.4MHz
LQH43NZ820J03□	—	82μH ±5%	1MHz	170mA	2.2Ω	35	1MHz	7.5MHz
LQH43NZ820K03□	—	82μH ±10%	1MHz	170mA	2.2Ω	35	1MHz	7.5MHz
LQH43NZ101J03□	—	100μH ±5%	1MHz	160mA	2.5Ω	40	796kHz	6.8MHz
LQH43NZ101K03□	—	100μH ±10%	1MHz	160mA	2.5Ω	40	796kHz	6.8MHz
LQH43NZ121J03□	—	120μH ±5%	1MHz	150mA	3.0Ω	40	796kHz	6.2MHz
LQH43NZ121K03□	—	120μH ±10%	1MHz	150mA	3.0Ω	40	796kHz	6.2MHz
LQH43NZ151J03□	—	150μH ±5%	1MHz	130mA	3.7Ω	40	796kHz	5.5MHz
LQH43NZ151K03□	—	150μH ±10%	1MHz	130mA	3.7Ω	40	796kHz	5.5MHz
LQH43NZ181J03□	—	180μH ±5%	1MHz	120mA	4.5Ω	40	796kHz	5.0MHz
LQH43NZ181K03□	—	180μH ±10%	1MHz	120mA	4.5Ω	40	796kHz	5.0MHz
LQH43NZ221J03□	—	220μH ±5%	1MHz	110mA	5.4Ω	40	796kHz	4.5MHz
LQH43NZ221K03□	—	220μH ±10%	1MHz	110mA	5.4Ω	40	796kHz	4.5MHz
LQH43NZ271J03□	—	270μH ±5%	1MHz	100mA	6.8Ω	40	796kHz	4.0MHz
LQH43NZ271K03□	—	270μH ±10%	1MHz	100mA	6.8Ω	40	796kHz	4.0MHz
LQH43NZ331J03□	—	330μH ±5%	1MHz	95mA	8.2Ω	40	796kHz	3.6MHz
LQH43NZ331K03□	—	330μH ±10%	1MHz	95mA	8.2Ω	40	796kHz	3.6MHz
LQH43NZ391J03□	—	390μH ±5%	1MHz	90mA	9.7Ω	40	796kHz	3.3MHz
LQH43NZ391K03□	—	390μH ±10%	1MHz	90mA	9.7Ω	40	796kHz	3.3MHz
LQH43NZ471J03□	—	470μH ±5%	1kHz	80mA	11.8Ω	40	796kHz	3.0MHz
LQH43NZ471K03□	—	470μH ±10%	1kHz	80mA	11.8Ω	40	796kHz	3.0MHz
LQH43NZ561J03□	—	560μH ±5%	1kHz	70mA	14.5Ω	40	796kHz	2.7MHz
LQH43NZ561K03□	—	560μH ±10%	1kHz	70mA	14.5Ω	40	796kHz	2.7MHz
LQH43NZ681J03□	—	680μH ±5%	1kHz	65mA	17.0Ω	40	796kHz	2.5MHz
LQH43NZ681K03□	—	680μH ±10%	1kHz	65mA	17.0Ω	40	796kHz	2.5MHz
LQH43NZ821J03□	—	820μH ±5%	1kHz	60mA	20.5Ω	40	796kHz	2.2MHz
LQH43NZ821K03□	—	820μH ±10%	1kHz	60mA	20.5Ω	40	796kHz	2.2MHz
LQH43NZ102J03□	—	1000μH ±5%	1kHz	50mA	25.0Ω	40	252kHz	2.0MHz
LQH43NZ102K03□	—	1000μH ±10%	1kHz	50mA	25.0Ω	40	252kHz	2.0MHz
LQH43NZ122J03□	—	1200μH ±5%	1kHz	45mA	30.0Ω	40	252kHz	1.8MHz
LQH43NZ122K03□	—	1200μH ±10%	1kHz	45mA	30.0Ω	40	252kHz	1.8MHz
LQH43NZ152J03□	—	1500μH ±5%	1kHz	40mA	37.0Ω	40	252kHz	1.6MHz
LQH43NZ152K03□	—	1500μH ±10%	1kHz	40mA	37.0Ω	40	252kHz	1.6MHz
LQH43NZ182J03□	—	1800μH ±5%	1kHz	35mA	45.0Ω	40	252kHz	1.5MHz
LQH43NZ182K03□	—	1800μH ±10%	1kHz	35mA	45.0Ω	40	252kHz	1.5MHz
LQH43NZ222J03□	—	2200μH ±5%	1kHz	30mA	50.0Ω	40	252kHz	1.3MHz
LQH43NZ222K03□	—	2200μH ±10%	1kHz	30mA	50.0Ω	40	252kHz	1.3MHz

Class of Magnetic Shield: No magnetic shield
 Operating Temperature Range: -40°C~+105°C
 For reflow soldering only.

*1 When applied rated current to the products, self temperature rise shall be limited to 20°C max. and inductance will be within ±10% of initial inductance value.

Continued on the following page. 

△Note • Please read rating and △CAUTION (for storage, operating, rating, soldering, mounting and handling) in this catalog to prevent smoking and/or burning, etc.
 • This catalog has only typical specifications. Therefore, please approve our product specifications or transact the approval sheet for product specifications before ordering.

■ Q-Frequency Characteristics (Typ.)

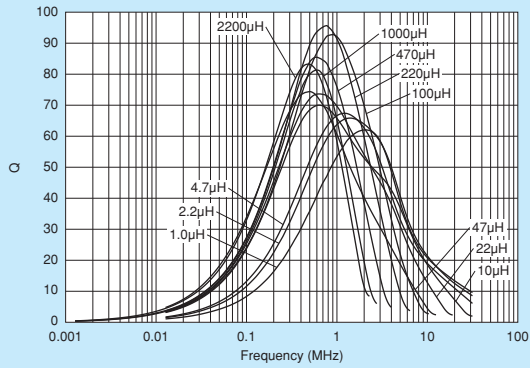

■ Inductance-Current Characteristics (Typ.)

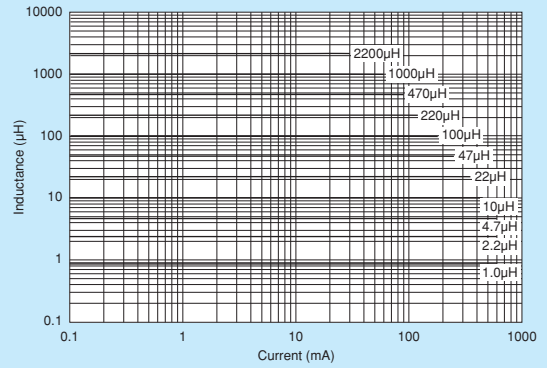

⚠Note • Please read rating and ⚠CAUTION (for storage, operating, rating, soldering, mounting and handling) in this catalog to prevent smoking and/or burning, etc.
 • This catalog has only typical specifications. Therefore, please approve our product specifications or transact the approval sheet for product specifications before ordering.

Inductors for Power Lines

Wire Wound Type (Ferrite Core)
Inductors for General Circuits

RF Inductors

⚠Caution

● Rating

1. About the Rated Current

Do not use products beyond the rated current as this may create excessive heat and deteriorate the insulation resistance.

2. About Excessive Surge Current

Surge current (pulse current or rush current) greater than the specified rated current applied to the product may cause a critical failure, such as an open circuit, burnout caused by excessive temperature rise.

Please contact us in advance in case of applying the surge current.

Notice

● Storage and Operating Condition

<Operating Environment>

Do not use products in chemical atmosphere such as chlorine gas, acid or sulfide gas.

<Storage Requirements>

1. Storage Period

LQH series should be used within 12 months. Check solderability if this period is exceeded.

2. Storage Conditions

(1) Store products in a warehouse in compliance with the following conditions:

Temperature: -10 to +40 degrees C.

Humidity: 15 to 85% (relative humidity)

Do not subject products to rapid changes in temperature and humidity.

Do not store them in chemical atmosphere such as one containing sulfurous acid gas or alkaline gas.

This will prevent electrode oxidation, which causes poor solderability and possible corrosion of inductors.

(2) Do not store products in bulk packaging to prevent collision among inductors, which causes core chipping and wire breakage.

(3) Store products on pallets to protect from humidity, dust, etc.

(4) Avoid heat shock, vibration, direct sunlight, etc.

● Handling

This item is designed to have sufficient strength, but handle with care to avoid chipping or breaking its ceramic structure.

LQH series

- To prevent breaking the wire, avoid touching with sharp material, such as tweezers or the bristles of a cleaning brush, to the wire wound portion of this product.
- To prevent breaking the core, avoid applying excessive mechanical shock to products mounted on the board.

<Handling>

1. Avoid applying excessive stress to products to prevent damage.

2. Do not touch wire wound with sharp objects such as tweezers to prevent wire breakage.

3. Do not apply excessive force to products mounted on boards to prevent core breakage.

<Transportation>

Do not apply excessive vibration or mechanical shock to products.

<Resin Coating>

When coating products with resin, the relatively high resin curing stress may change inductance values.

For exterior coating, select resin carefully so that electrical and mechanical performance of the product is not affected. Prior to use, please evaluate reliability with the product mounted in your application set.

(LQH series)

An open circuit issue may occur by mechanical stress caused by the resin, amount/cured shape of resin, or operating conditions, etc. Some resins containing impurities or chloride may possibly generate chlorine by hydrolysis under some operating conditions, causing corrosion of the inductor wire and leading to an open circuit.

<Handling of a Substrate>

After mounting products on a substrate, do not apply any stress to the product caused by bending or twisting the substrate when cropping the substrate, inserting and removing a connector from the substrate, or tightening a screw to the substrate. Excessive mechanical stress may cause cracking in the Product.

Bending

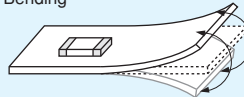

Twisting

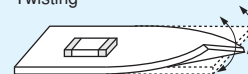

⚠Note • Please read rating and ⚠CAUTION (for storage, operating, rating, soldering, mounting and handling) in this catalog to prevent smoking and/or burning, etc.
• This catalog has only typical specifications. Therefore, please approve our product specifications or transact the approval sheet for product specifications before ordering.

1. Standard Land Pattern Dimensions

A high Q value is achieved when the PCB electrode land pattern is designed so that it does not project beyond the chip Inductors (chip coils) electrode.

Land Pattern + Solder Resist
 Land Pattern
 Solder Resist
 (in mm)

Series	Standard Land Dimensions
LQH31H	
LQH43N	

Attention should be paid to potential magnetic coupling effects when using the Inductors (coils) as a resonator.

2. Standard Soldering Conditions

(1) Soldering method

Chip Inductors (Chip coils) can be flow or reflow soldered.
 Please contact Murata regarding other soldering methods.

Solder: Use Sn-3.0Ag-0.5Cu solder.

Flux: Use rosin-based flux, but not strongly acidic flux (with chlorine content exceeding 0.2wt%).

Do not use water-soluble flux.

For additional mounting methods, please contact Murata.

(2) Soldering profile

● Flow Soldering profile
 (Sn-3.0Ag-0.5Cu solder)

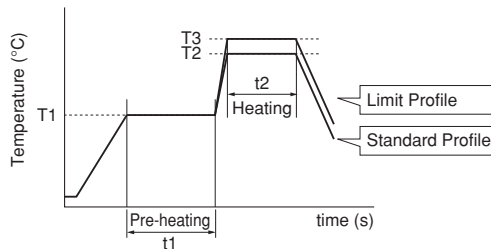

Series	Pre-heating		Standard Profile			Limit Profile		
	Temp. (T1)	Time. (t1)	Heating		Cycle of flow	Heating		Cycle of flow
			Temp. (T2)	Time. (t2)		Temp. (T3)	Time. (t2)	
LQH31H	150°C	60s min.	250°C	4 to 6s	2 times max.	265±3°C	5s max.	2 times max.

Continued on the following page.

⚠Note • Please read rating and ⚠CAUTION (for storage, operating, rating, soldering, mounting and handling) in this catalog to prevent smoking and/or burning, etc.
 • This catalog has only typical specifications. Therefore, please approve our product specifications or transact the approval sheet for product specifications before ordering.

● Reflow Soldering profile
(Sn-3.0Ag-0.5Cu solder)

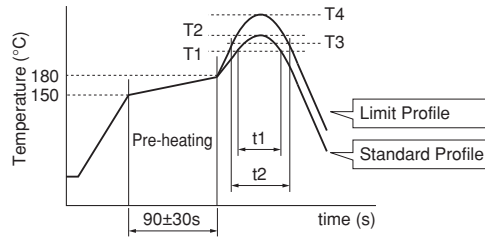

Series	Standard Profile				Limit Profile			
	Heating		Peak temperature (T2)	Cycle of reflow	Heating		Peak temperature (T4)	Cycle of reflow
	Temp. (T1)	Time. (t1)			Temp. (T3)	Time. (t2)		
LQH31H/43N	220°C	30 to 60s	245±3°C	2 times max.	230°C	60s max.	260°C/10s	2 times max.

(3) Reworking with Soldering Iron

Preheating at 150°C for 1 minute is required. Do not directly touch the ceramic element with the tip of the soldering iron. The reworking soldering conditions are as follows:

- Soldering iron power output: 80W max.
- Temperature of soldering iron tip: 350°C
- Diameter of soldering iron end: 3.0mm max.
- Soldering time: within 3 s

3. Mounting Instructions

(1) Land Pattern Dimensions

Large lands reduce Q of the mounted chip. Also, large protruding land areas (bordered by lines having dimensions 'c' and 'd' shown) cause floating and electrode leaching.

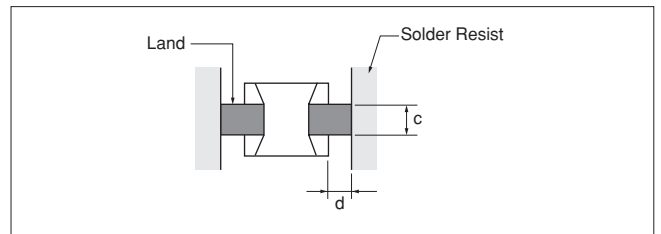

(2) Land Pattern Designing (LQH series)

Please follow the recommended patterns. Otherwise, their performance, which includes electrical performance or solderability, may be affected, or result in "position shift" in the soldering process.

(3) Magnetic Coupling

Since some chip inductors (chip coils) are constructed like an open magnetic circuit, narrow spacing between inductors (coils) may cause magnetic coupling.

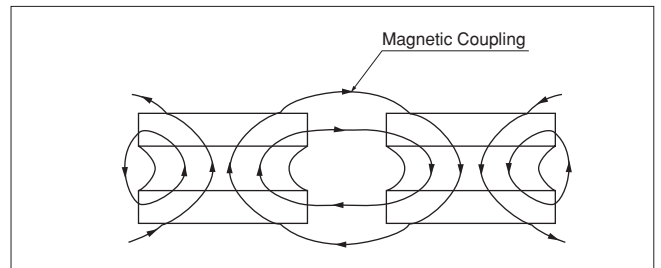

Continued on the following page. ↗

⚠Note • Please read rating and ⚠CAUTION (for storage, operating, rating, soldering, mounting and handling) in this catalog to prevent smoking and/or burning, etc.
• This catalog has only typical specifications. Therefore, please approve our product specifications or transact the approval sheet for product specifications before ordering.

Inductors for Power Lines
Soldering and Mounting
Inductors for General Circuits
RF Inductors

(4) PCB Warping

PCB should be designed so that products are not subjected to the mechanical stress caused by warping the board.

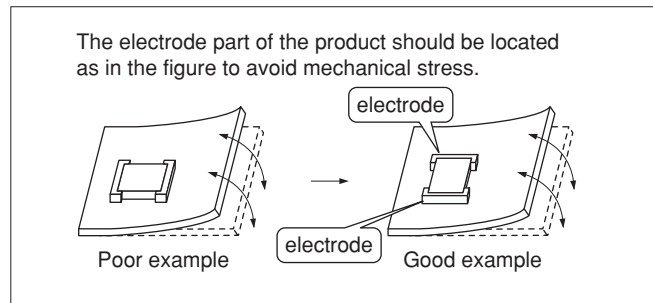
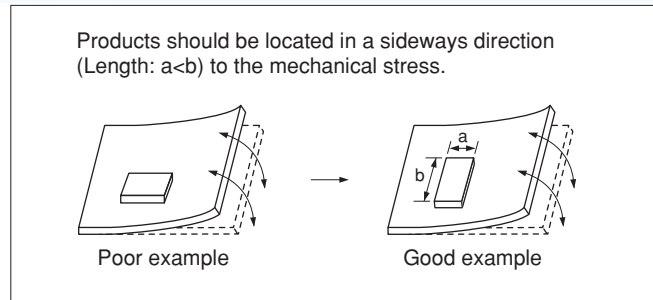

(5) Amount of Solder Paste

Excessive solder causes electrode corrosion, while insufficient solder causes low electrode bonding strength. Adjust the amount of solder paste as shown on the right so that solder is applied.

- Guideline of solder paste thickness
LQH : 200 to 300 μ m

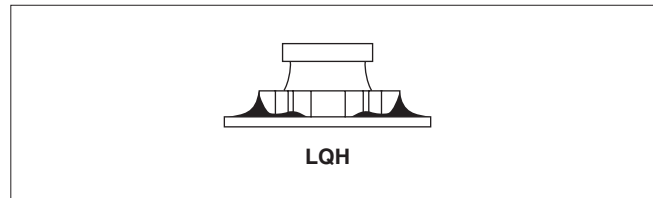

4. Cleaning

The following conditions should be observed when cleaning chip inductors (chip coils):

- (1) Cleaning Temperature: 60°C max. (40°C max. for alcohol cleaning agents)
- (2) Ultrasonic
 - Output: 20W/l max.
 - Duration: 5 minutes max.
 - Frequency: 28 to 40kHz
 - Care should be taken not to cause resonance of the PCB and mounted products.
- (3) Cleaning agent
 - The following cleaning agents have been tested on individual components. Evaluation in complete assembly should be done prior to production.

- (a) Alcohol cleaning agents
Isopropyl alcohol (IPA)
- (b) Aqueous cleaning agents
Pine Alpha ST-100S
- (4) Ensure that flux residue is completely removed. Component should be thoroughly dried after aqueous agents have been removed with deionized water.

For additional cleaning methods, please contact Murata.

⚠Note • Please read rating and ⚠CAUTION (for storage, operating, rating, soldering, mounting and handling) in this catalog to prevent smoking and/or burning, etc.
• This catalog has only typical specifications. Therefore, please approve our product specifications or transact the approval sheet for product specifications before ordering.

Inductors for Power Lines
Inductors for General Circuits
Soldering and Mounting
RF Inductors

■ Minimum Quantity and 12mm Width Embossed Taping Dimensions

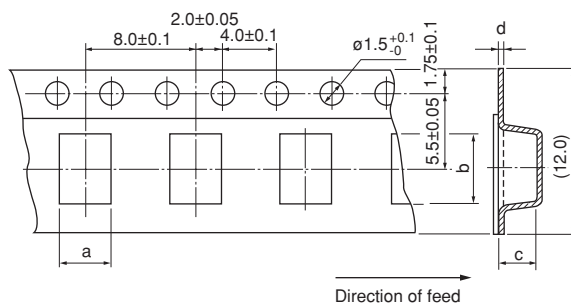

Dimension of the cavity of embossed tape is measured at the bottom side.

Embossed Tape

Part Number	Dimensions (c: Depth of Cavity)				Packaging Code (Minimum Qty. [pcs.])		
	a	b	c	d	ø180mm reel	ø330mm reel	Bulk
LQH43N	3.6	4.9	2.7	0.3	L [500]	K [2500]	-

(in mm)

■ Minimum Quantity and 8mm Width Taping Dimensions

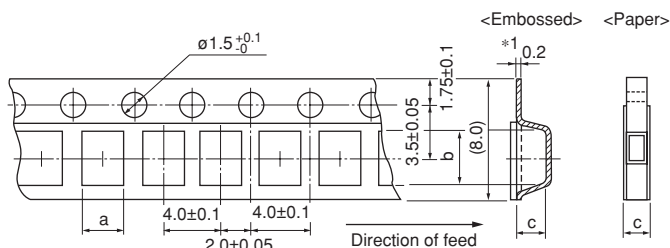

Dimension of the cavity of embossed tape is measured at the bottom side.

Embossed Tape

Part Number	Dimensions		Depth of Cavity	Packaging Code (Minimum Qty. [pcs.])		
	a	b	c	ø180mm reel	ø330mm reel	Bulk
LQH31H	1.9	3.6	2.0	L [2000]	K [7500]	-

(in mm)

△Note • Please read rating and △CAUTION (for storage, operating, rating, soldering, mounting and handling) in this catalog to prevent smoking and/or burning, etc.
• This catalog has only typical specifications. Therefore, please approve our product specifications or transact the approval sheet for product specifications before ordering.



RF Inductors Part Numbering

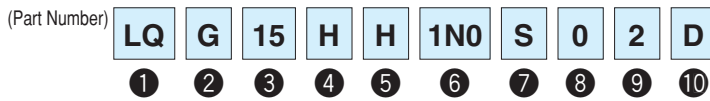

① Product ID

Product ID	
LQ	Chip Inductors (Chip Coils)

② Structure

Code	Structure
G	Multilayer Type (Air-core Inductors (Coils))
P	Film Type
W	Wire Wound Type (Air-core Inductors (Coils))

③ Dimensions (L×W)

Code	Dimensions (L×W)	Size Code (in inch)
03	0.6×0.3mm	0201
15	1.0×0.5mm	0402
18	1.6×0.8mm	0603

④ Applications and Characteristics

Code	Series	Applications and Characteristics
H	LQG	Multilayer Air-core Inductors (Coils)
T	LQP	Film Type (Low DC Resistance Type)
A	LQW	High Q Type (UHF-SHF)

⑤ Category

Code	Series	Category	
N	LQP/LQW	Standard Type	
Z	LQG	Automotive	Infotainment
H			Powertrain/Safety

⑩ Packaging

Code	Packaging	Series
B	Bulk	LQW/LQG/LQP
J	Paper Taping (ø330mm Reel)	LQW18A/LQG/LQP
D	Paper Taping (ø180mm Reel)	LQW/LQG/LQP

⑥ Inductance

Expressed by three-digit alphanumerics. The unit is micro-henry (μH). The first and second figures are significant digits, and the third figure expresses the number of zeros that follow the two figures. If there is a decimal point, it is expressed by the capital letter "R." In this case, all figures are significant digits. If inductance is less than $0.1\mu\text{H}$, the inductance code is expressed by a combination of two figures and the capital letter "N," and the unit of inductance is nano-henry (nH).

The capital letter "N" indicates the unit of "nH," and also expresses a decimal point. In this case, all figures are significant digits.

⑦ Inductance Tolerance

Code	Inductance Tolerance
B	$\pm 0.1\text{nH}$
C	$\pm 0.2\text{nH}$
D	$\pm 0.5\text{nH}$
G	$\pm 2\%$
H	$\pm 3\%$
J	$\pm 5\%$
S	$\pm 0.3\text{nH}$
W	$\pm 0.05\text{nH}$

⑧ Features

Code	Features	Series
0	Standard Type	LQG/LQP/LQW
1	High-Q, Low DC Resistance	LQW15A/18A
Z	for Infotainment	LQP03T

⑨ Electrode

•Lead (Pb) Free

Code	Electrode	Series
0	Sn	LQG18H
2		LQG15H/LQP03T
Z	for Infotainment	LQW15A/LQW18W

⚠Note • Please read rating and ⚠CAUTION (for storage, operating, rating, soldering, mounting and handling) in this catalog to prevent smoking and/or burning, etc.
• This catalog has only typical specifications. Therefore, please approve our product specifications or transact the approval sheet for product specifications before ordering.

Multilayer Type (Non-Magnetic Core)

LQG15H_02 Series 0402/1005 (inch/mm)

Size Code 0402 (1005) in inch (in mm), Multilayer Type

■ Appearance/Dimensions

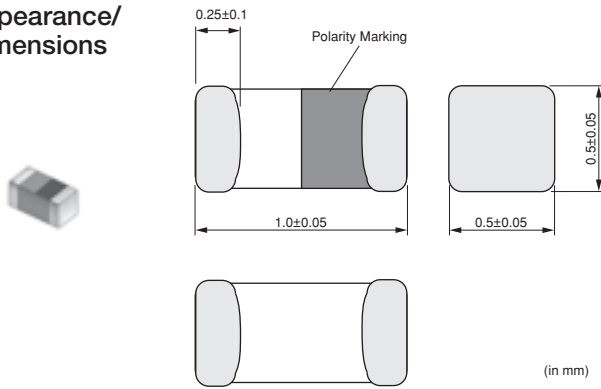

■ Packaging

Code	Packaging	Minimum Quantity
D	ø180mm Paper Taping	10000
J	ø330mm Paper Taping	50000
B	Packing in Bulk	1000



Refer to pages from p.230 to p.232 for mounting information.

■ Rated Value (□: packaging code)

Part Number		Inductance	Inductance Test Frequency	Rated Current	Max. of DC Resistance	Q (min.)	Q Test Frequency	Self-Resonance Frequency (min.)
For Infotainment	For Powertrain/Safety							
LQG15HZ1N0S02□	LQG15HH1N0S0□	1.0nH ±0.3nH	100MHz	300mA	0.07Ω	8	100MHz	10000MHz
LQG15HZ1N1S02□	LQG15HH1N1S0□	1.1nH ±0.3nH	100MHz	300mA	0.09Ω	8	100MHz	6000MHz
LQG15HZ1N2S02□	LQG15HH1N2S0□	1.2nH ±0.3nH	100MHz	300mA	0.09Ω	8	100MHz	6000MHz
LQG15HZ1N3S02□	LQG15HH1N3S0□	1.3nH ±0.3nH	100MHz	300mA	0.09Ω	8	100MHz	6000MHz
LQG15HZ1N5S02□	LQG15HH1N5S0□	1.5nH ±0.3nH	100MHz	300mA	0.10Ω	8	100MHz	6000MHz
LQG15HZ1N6S02□	LQG15HH1N6S0□	1.6nH ±0.3nH	100MHz	300mA	0.10Ω	8	100MHz	6000MHz
LQG15HZ1N8S02□	LQG15HH1N8S0□	1.8nH ±0.3nH	100MHz	300mA	0.10Ω	8	100MHz	6000MHz
LQG15HZ2N0S02□	LQG15HH2N0S0□	2.0nH ±0.3nH	100MHz	300mA	0.10Ω	8	100MHz	6000MHz
LQG15HZ2N2S02□	LQG15HH2N2S0□	2.2nH ±0.3nH	100MHz	300mA	0.12Ω	8	100MHz	6000MHz
LQG15HZ2N4S02□	LQG15HH2N4S0□	2.4nH ±0.3nH	100MHz	300mA	0.15Ω	8	100MHz	6000MHz
LQG15HZ2N7S02□	LQG15HH2N7S0□	2.7nH ±0.3nH	100MHz	300mA	0.15Ω	8	100MHz	6000MHz
LQG15HZ3N0S02□	LQG15HH3N0S0□	3.0nH ±0.3nH	100MHz	300mA	0.17Ω	8	100MHz	6000MHz
LQG15HZ3N3S02□	LQG15HH3N3S0□	3.3nH ±0.3nH	100MHz	300mA	0.17Ω	8	100MHz	6000MHz
LQG15HZ3N6S02□	LQG15HH3N6S0□	3.6nH ±0.3nH	100MHz	300mA	0.18Ω	8	100MHz	6000MHz
LQG15HZ3N9S02□	LQG15HH3N9S0□	3.9nH ±0.3nH	100MHz	300mA	0.18Ω	8	100MHz	6000MHz
LQG15HZ4N3S02□	LQG15HH4N3S0□	4.3nH ±0.3nH	100MHz	300mA	0.18Ω	8	100MHz	6000MHz
LQG15HZ4N7S02□	LQG15HH4N7S0□	4.7nH ±0.3nH	100MHz	300mA	0.18Ω	8	100MHz	6000MHz
LQG15HZ5N1S02□	LQG15HH5N1S0□	5.1nH ±0.3nH	100MHz	300mA	0.20Ω	8	100MHz	5300MHz
LQG15HZ5N6S02□	LQG15HH5N6S0□	5.6nH ±0.3nH	100MHz	300mA	0.20Ω	8	100MHz	4500MHz
LQG15HZ6N2S02□	LQG15HH6N2S0□	6.2nH ±0.3nH	100MHz	300mA	0.22Ω	8	100MHz	4500MHz
LQG15HZ6N8J02□	LQG15HH6N8J0□	6.8nH ±5%	100MHz	300mA	0.24Ω	8	100MHz	4500MHz
LQG15HZ7N5J02□	LQG15HH7N5J0□	7.5nH ±5%	100MHz	300mA	0.24Ω	8	100MHz	4200MHz
LQG15HZ8N2J02□	LQG15HH8N2J0□	8.2nH ±5%	100MHz	300mA	0.24Ω	8	100MHz	3700MHz
LQG15HZ9N1J02□	LQG15HH9N1J0□	9.1nH ±5%	100MHz	300mA	0.26Ω	8	100MHz	3400MHz
LQG15HZ10N0J02□	LQG15HH10N0J0□	10nH ±5%	100MHz	300mA	0.26Ω	8	100MHz	3400MHz
LQG15HZ12N0J02□	LQG15HH12N0J0□	12nH ±5%	100MHz	300mA	0.28Ω	8	100MHz	3000MHz
LQG15HZ15N0J02□	LQG15HH15N0J0□	15nH ±5%	100MHz	300mA	0.32Ω	8	100MHz	2500MHz
LQG15HZ18N0J02□	LQG15HH18N0J0□	18nH ±5%	100MHz	300mA	0.36Ω	8	100MHz	2200MHz
LQG15HZ22N0J02□	LQG15HH22N0J0□	22nH ±5%	100MHz	300mA	0.42Ω	8	100MHz	1900MHz
LQG15HZ27N0J02□	LQG15HH27N0J0□	27nH ±5%	100MHz	300mA	0.46Ω	8	100MHz	1700MHz
LQG15HZ33N0J02□	LQG15HH33N0J0□	33nH ±5%	100MHz	200mA	0.58Ω	8	100MHz	1600MHz
LQG15HZ39N0J02□	LQG15HH39N0J0□	39nH ±5%	100MHz	200mA	0.65Ω	8	100MHz	1200MHz

Operating Temperature Range (Self-temperature rise is not included): -55°C~+125°C
For reflow soldering only.

Continued on the following page.

△Note • Please read rating and △CAUTION (for storage, operating, rating, soldering, mounting and handling) in this catalog to prevent smoking and/or burning, etc.
• This catalog has only typical specifications. Therefore, please approve our product specifications or transact the approval sheet for product specifications before ordering.

Part Number		Inductance	Inductance Test Frequency	Rated Current	Max. of DC Resistance	Q (min.)	Q Test Frequency	Self-Resonance Frequency (min.)
For Infotainment	For Powertrain/Safety							
LQG15HZ47NJ02□	LQG15HH47NJ0□	47nH ±5%	100MHz	200mA	0.72 Ω	8	100MHz	1000MHz
LQG15HZ56NJ02□	LQG15HH56NJ0□	56nH ±5%	100MHz	200mA	0.82 Ω	8	100MHz	800MHz
LQG15HZ68NJ02□	LQG15HH68NJ0□	68nH ±5%	100MHz	180mA	0.92 Ω	8	100MHz	800MHz
LQG15HZ82NJ02□	LQG15HH82NJ0□	82nH ±5%	100MHz	150mA	1.20 Ω	8	100MHz	700MHz
LQG15HZR10J02□	LQG15HHR10J0□	100nH ±5%	100MHz	150mA	1.25 Ω	8	100MHz	600MHz
LQG15HZR12J02□	LQG15HHR12J0□	120nH ±5%	100MHz	150mA	1.30 Ω	8	100MHz	600MHz
LQG15HZR15J02□	LQG15HHR15J0□	150nH ±5%	100MHz	140mA	2.99 Ω	8	100MHz	550MHz
LQG15HZR18J02□	LQG15HHR18J0□	180nH ±5%	100MHz	130mA	3.38 Ω	8	100MHz	500MHz
LQG15HZR22J02□	LQG15HHR22J0□	220nH ±5%	100MHz	120mA	3.77 Ω	8	100MHz	450MHz
LQG15HZR27J02□	LQG15HHR27J0□	270nH ±5%	100MHz	110mA	4.94 Ω	8	100MHz	400MHz

Operating Temperature Range (Self-temperature rise is not included): -55°C~+125°C
For reflow soldering only.

■ Q-Frequency Characteristics (Typ.)

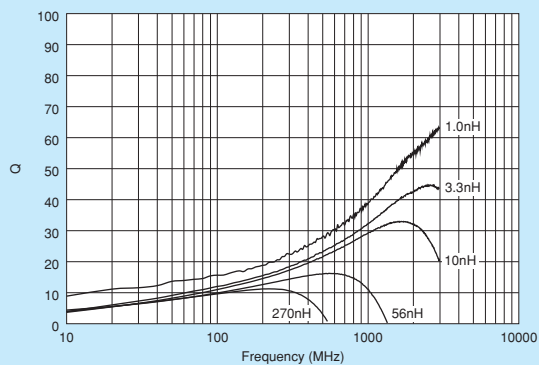

■ Inductance-Frequency Characteristics (Typ.)

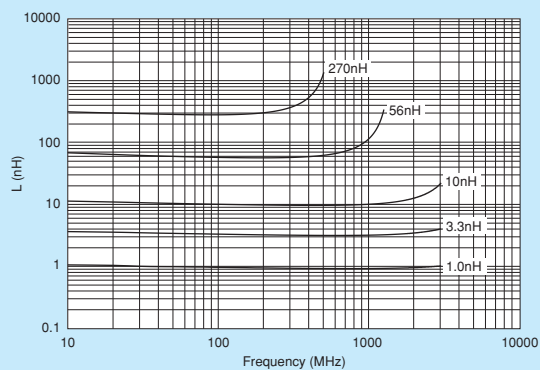

⚠Note • Please read rating and ⚠CAUTION (for storage, operating, rating, soldering, mounting and handling) in this catalog to prevent smoking and/or burning, etc.
• This catalog has only typical specifications. Therefore, please approve our product specifications or transact the approval sheet for product specifications before ordering.

Multilayer Type (Non-Magnetic Core)

LQG18HH_00 Series 0603/1608 (inch/mm)

Size Code 0603 (1608) in inch (in mm), Multilayer Type

■ Appearance/Dimensions

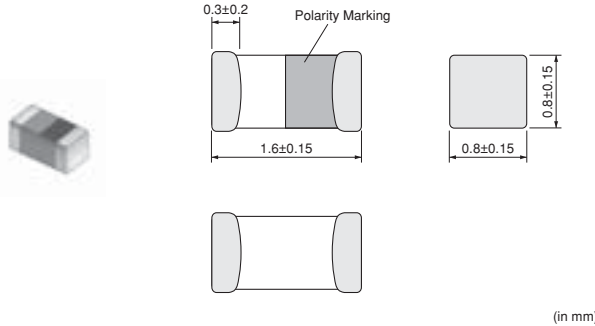

■ Packaging

Code	Packaging	Minimum Quantity
D	ø180mm Paper Taping	4000
J	ø330mm Paper Taping	10000
B	Packing in Bulk	1000

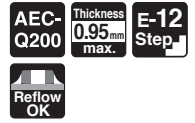

Refer to pages from p.230 to p.232 for mounting information.

■ Rated Value (□: packaging code)

Part Number		Inductance	Inductance Test Frequency	Rated Current	Max. of DC Resistance	Q (min.)	Q Test Frequency	Self-Resonance Frequency (min.)
For Infotainment	For Powertrain/Safety							
—	LQG18HH1N2S00□	1.2nH ±0.3nH	100MHz	1100mA	0.10Ω	12	100MHz	6000MHz
—	LQG18HH1N5S00□	1.5nH ±0.3nH	100MHz	1100mA	0.10Ω	12	100MHz	6000MHz
—	LQG18HH1N8S00□	1.8nH ±0.3nH	100MHz	1100mA	0.10Ω	12	100MHz	5000MHz
—	LQG18HH2N2S00□	2.2nH ±0.3nH	100MHz	1100mA	0.10Ω	12	100MHz	5000MHz
—	LQG18HH2N7S00□	2.7nH ±0.3nH	100MHz	1000mA	0.13Ω	12	100MHz	4000MHz
—	LQG18HH3N3S00□	3.3nH ±0.3nH	100MHz	900mA	0.14Ω	12	100MHz	4000MHz
—	LQG18HH3N9S00□	3.9nH ±0.3nH	100MHz	900mA	0.15Ω	12	100MHz	3000MHz
—	LQG18HH4N7S00□	4.7nH ±0.3nH	100MHz	800mA	0.16Ω	12	100MHz	3000MHz
—	LQG18HH5N6S00□	5.6nH ±0.3nH	100MHz	800mA	0.17Ω	12	100MHz	3000MHz
—	LQG18HH6N2S00□	6.2nH ±0.3nH	100MHz	800mA	0.18Ω	12	100MHz	2800MHz
—	LQG18HH6N8J00□	6.8nH ±5%	100MHz	800mA	0.18Ω	12	100MHz	2800MHz
—	LQG18HH8N2J00□	8.2nH ±5%	100MHz	800mA	0.20Ω	12	100MHz	2600MHz
—	LQG18HH10NJ00□	10nH ±5%	100MHz	700mA	0.25Ω	12	100MHz	2400MHz
—	LQG18HH12NJ00□	12nH ±5%	100MHz	600mA	0.30Ω	12	100MHz	2200MHz
—	LQG18HH15NJ00□	15nH ±5%	100MHz	600mA	0.35Ω	12	100MHz	1800MHz
—	LQG18HH18NJ00□	18nH ±5%	100MHz	600mA	0.35Ω	12	100MHz	1800MHz
—	LQG18HH22NJ00□	22nH ±5%	100MHz	500mA	0.50Ω	12	100MHz	1600MHz
—	LQG18HH27NJ00□	27nH ±5%	100MHz	500mA	0.54Ω	12	100MHz	1400MHz
—	LQG18HH33NJ00□	33nH ±5%	100MHz	500mA	0.54Ω	12	100MHz	1200MHz
—	LQG18HH39NJ00□	39nH ±5%	100MHz	400mA	0.60Ω	12	100MHz	1000MHz
—	LQG18HH47NJ00□	47nH ±5%	100MHz	400mA	0.70Ω	12	100MHz	900MHz
—	LQG18HH56NJ00□	56nH ±5%	100MHz	400mA	0.70Ω	12	100MHz	800MHz
—	LQG18HH68NJ00□	68nH ±5%	100MHz	400mA	0.80Ω	12	100MHz	800MHz
—	LQG18HH82NJ00□	82nH ±5%	100MHz	300mA	0.85Ω	12	100MHz	700MHz
—	LQG18HHR10J00□	100nH ±5%	100MHz	300mA	0.90Ω	12	100MHz	600MHz
—	LQG18HHR12J00□	120nH ±5%	100MHz	300mA	1.10Ω	14	100MHz	550MHz
—	LQG18HHR15J00□	150nH ±5%	100MHz	300mA	1.20Ω	14	100MHz	550MHz
—	LQG18HHR18J00□	180nH ±5%	100MHz	300mA	1.30Ω	14	100MHz	500MHz
—	LQG18HHR22J00□	220nH ±5%	100MHz	300mA	1.50Ω	14	100MHz	450MHz
—	LQG18HHR27J00□	270nH ±5%	100MHz	200mA	1.90Ω	14	100MHz	400MHz

Operating Temperature Range (Self-temperature rise is not included): -55°C~+125°C
For reflow soldering only.

Continued on the following page. ↗

△Note • Please read rating and △CAUTION (for storage, operating, rating, soldering, mounting and handling) in this catalog to prevent smoking and/or burning, etc.
• This catalog has only typical specifications. Therefore, please approve our product specifications or transact the approval sheet for product specifications before ordering.

Inductors for Power Lines
Inductors for General Circuits
RF Inductors
Multilayer Type (Non-Magnetic Core)

■ Q-Frequency Characteristics (Typ.)

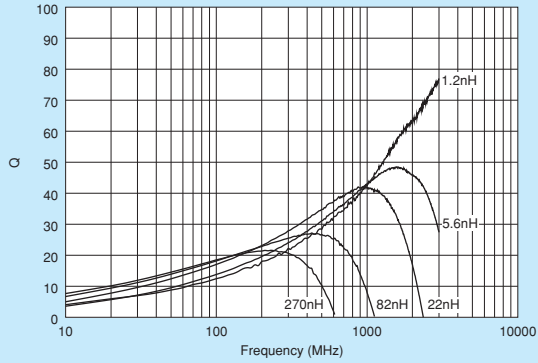

■ Inductance-Frequency Characteristics (Typ.)

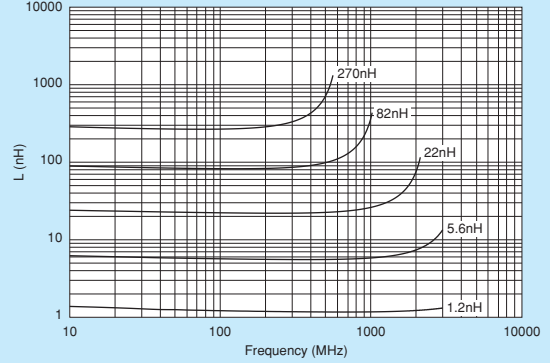

Inductors for Power Lines

Inductors for General Circuits

Multilayer Type (Non-Magnetic Core)
RF Inductors

⚠Note • Please read rating and ⚠CAUTION (for storage, operating, rating, soldering, mounting and handling) in this catalog to prevent smoking and/or burning, etc.
• This catalog has only typical specifications. Therefore, please approve our product specifications or transact the approval sheet for product specifications before ordering.

Film Type (Non-Magnetic Core)

LQP03TN_Z2 Series 0201/0603 (inch/mm)

Size Code 0201 (0603) in inch (in mm), High Q, Wide Variation

■ Appearance/Dimensions

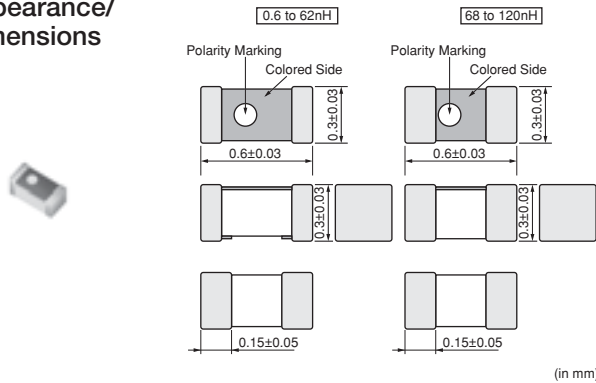

■ Packaging

Code	Packaging	Minimum Quantity
D	ø180mm Paper Taping	15000
J	ø330mm Paper Taping	50000
B	Packing in Bulk	500



Refer to pages from p.230 to p.232 for mounting information.

■ Rated Value (□: packaging code)

Part Number		Inductance	Inductance Test Frequency	Rated Current	Max. of DC Resistance	Q (min.)	Q Test Frequency	Self-Resonance Frequency (min.)
For Infotainment	For Powertrain/Safety							
LQP03TN0N6BZ2□	—	0.6nH ±0.1nH	500MHz	850mA	0.07Ω	14	500MHz	20000MHz
LQP03TN0N6CZ2□	—	0.6nH ±0.2nH	500MHz	850mA	0.07Ω	14	500MHz	20000MHz
LQP03TN0N7BZ2□	—	0.7nH ±0.1nH	500MHz	800mA	0.08Ω	14	500MHz	20000MHz
LQP03TN0N7CZ2□	—	0.7nH ±0.2nH	500MHz	800mA	0.08Ω	14	500MHz	20000MHz
LQP03TN0N8BZ2□	—	0.8nH ±0.1nH	500MHz	800mA	0.08Ω	14	500MHz	18000MHz
LQP03TN0N8CZ2□	—	0.8nH ±0.2nH	500MHz	800mA	0.08Ω	14	500MHz	18000MHz
LQP03TN0N9BZ2□	—	0.9nH ±0.1nH	500MHz	750mA	0.10Ω	14	500MHz	18000MHz
LQP03TN0N9CZ2□	—	0.9nH ±0.2nH	500MHz	750mA	0.10Ω	14	500MHz	18000MHz
LQP03TN1N0BZ2□	—	1.0nH ±0.1nH	500MHz	750mA	0.10Ω	14	500MHz	17000MHz
LQP03TN1N0CZ2□	—	1.0nH ±0.2nH	500MHz	750mA	0.10Ω	14	500MHz	17000MHz
LQP03TN1N1BZ2□	—	1.1nH ±0.1nH	500MHz	750mA	0.10Ω	14	500MHz	17000MHz
LQP03TN1N1CZ2□	—	1.1nH ±0.2nH	500MHz	750mA	0.10Ω	14	500MHz	17000MHz
LQP03TN1N2BZ2□	—	1.2nH ±0.1nH	500MHz	750mA	0.10Ω	14	500MHz	17000MHz
LQP03TN1N2CZ2□	—	1.2nH ±0.2nH	500MHz	750mA	0.10Ω	14	500MHz	17000MHz
LQP03TN1N3BZ2□	—	1.3nH ±0.1nH	500MHz	600mA	0.15Ω	14	500MHz	17000MHz
LQP03TN1N3CZ2□	—	1.3nH ±0.2nH	500MHz	600mA	0.15Ω	14	500MHz	17000MHz
LQP03TN1N4BZ2□	—	1.4nH ±0.1nH	500MHz	600mA	0.15Ω	14	500MHz	16000MHz
LQP03TN1N4CZ2□	—	1.4nH ±0.2nH	500MHz	600mA	0.15Ω	14	500MHz	16000MHz
LQP03TN1N5BZ2□	—	1.5nH ±0.1nH	500MHz	600mA	0.15Ω	14	500MHz	15000MHz
LQP03TN1N5CZ2□	—	1.5nH ±0.2nH	500MHz	600mA	0.15Ω	14	500MHz	15000MHz
LQP03TN1N6BZ2□	—	1.6nH ±0.1nH	500MHz	600mA	0.15Ω	14	500MHz	15000MHz
LQP03TN1N6CZ2□	—	1.6nH ±0.2nH	500MHz	600mA	0.15Ω	14	500MHz	15000MHz
LQP03TN1N7BZ2□	—	1.7nH ±0.1nH	500MHz	600mA	0.15Ω	14	500MHz	15000MHz
LQP03TN1N7CZ2□	—	1.7nH ±0.2nH	500MHz	600mA	0.15Ω	14	500MHz	15000MHz
LQP03TN1N8BZ2□	—	1.8nH ±0.1nH	500MHz	600mA	0.15Ω	14	500MHz	15000MHz
LQP03TN1N8CZ2□	—	1.8nH ±0.2nH	500MHz	600mA	0.15Ω	14	500MHz	15000MHz
LQP03TN1N9BZ2□	—	1.9nH ±0.1nH	500MHz	600mA	0.15Ω	14	500MHz	12500MHz
LQP03TN1N9CZ2□	—	1.9nH ±0.2nH	500MHz	600mA	0.15Ω	14	500MHz	12500MHz
LQP03TN2N0BZ2□	—	2.0nH ±0.1nH	500MHz	600mA	0.15Ω	14	500MHz	12500MHz
LQP03TN2N0CZ2□	—	2.0nH ±0.2nH	500MHz	600mA	0.15Ω	14	500MHz	12500MHz
LQP03TN2N1BZ2□	—	2.1nH ±0.1nH	500MHz	600mA	0.15Ω	14	500MHz	11000MHz
LQP03TN2N1CZ2□	—	2.1nH ±0.2nH	500MHz	600mA	0.15Ω	14	500MHz	11000MHz

Operating Temperature Range (Self-temperature rise is not included): -55°C~+125°C
For reflow soldering only.

Continued on the following page.

△Note • Please read rating and △CAUTION (for storage, operating, rating, soldering, mounting and handling) in this catalog to prevent smoking and/or burning, etc.
• This catalog has only typical specifications. Therefore, please approve our product specifications or transact the approval sheet for product specifications before ordering.

Part Number		Inductance	Inductance Test Frequency	Rated Current	Max. of DC Resistance	Q (min.)	Q Test Frequency	Self-Resonance Frequency (min.)
For Infotainment	For Powertrain/Safety							
LQP03TN2N2BZ2□	—	2.2nH ±0.1nH	500MHz	600mA	0.15 Ω	14	500MHz	11000MHz
LQP03TN2N2CZ2□	—	2.2nH ±0.2nH	500MHz	600mA	0.15 Ω	14	500MHz	11000MHz
LQP03TN2N3BZ2□	—	2.3nH ±0.1nH	500MHz	500mA	0.20 Ω	14	500MHz	10000MHz
LQP03TN2N3CZ2□	—	2.3nH ±0.2nH	500MHz	500mA	0.20 Ω	14	500MHz	10000MHz
LQP03TN2N4BZ2□	—	2.4nH ±0.1nH	500MHz	500mA	0.20 Ω	14	500MHz	10000MHz
LQP03TN2N4CZ2□	—	2.4nH ±0.2nH	500MHz	500mA	0.20 Ω	14	500MHz	10000MHz
LQP03TN2N5BZ2□	—	2.5nH ±0.1nH	500MHz	500mA	0.20 Ω	14	500MHz	10000MHz
LQP03TN2N5CZ2□	—	2.5nH ±0.2nH	500MHz	500mA	0.20 Ω	14	500MHz	10000MHz
LQP03TN2N6BZ2□	—	2.6nH ±0.1nH	500MHz	500mA	0.20 Ω	14	500MHz	10000MHz
LQP03TN2N6CZ2□	—	2.6nH ±0.2nH	500MHz	500mA	0.20 Ω	14	500MHz	10000MHz
LQP03TN2N7BZ2□	—	2.7nH ±0.1nH	500MHz	500mA	0.20 Ω	14	500MHz	10000MHz
LQP03TN2N7CZ2□	—	2.7nH ±0.2nH	500MHz	500mA	0.20 Ω	14	500MHz	10000MHz
LQP03TN2N8BZ2□	—	2.8nH ±0.1nH	500MHz	500mA	0.20 Ω	14	500MHz	9500MHz
LQP03TN2N8CZ2□	—	2.8nH ±0.2nH	500MHz	500mA	0.20 Ω	14	500MHz	9500MHz
LQP03TN2N9BZ2□	—	2.9nH ±0.1nH	500MHz	500mA	0.20 Ω	14	500MHz	9500MHz
LQP03TN2N9CZ2□	—	2.9nH ±0.2nH	500MHz	500mA	0.20 Ω	14	500MHz	9500MHz
LQP03TN3N0BZ2□	—	3.0nH ±0.1nH	500MHz	450mA	0.25 Ω	14	500MHz	9500MHz
LQP03TN3N0CZ2□	—	3.0nH ±0.2nH	500MHz	450mA	0.25 Ω	14	500MHz	9500MHz
LQP03TN3N1BZ2□	—	3.1nH ±0.1nH	500MHz	450mA	0.25 Ω	14	500MHz	8000MHz
LQP03TN3N1CZ2□	—	3.1nH ±0.2nH	500MHz	450mA	0.25 Ω	14	500MHz	8000MHz
LQP03TN3N2BZ2□	—	3.2nH ±0.1nH	500MHz	450mA	0.25 Ω	14	500MHz	8000MHz
LQP03TN3N2CZ2□	—	3.2nH ±0.2nH	500MHz	450mA	0.25 Ω	14	500MHz	8000MHz
LQP03TN3N3BZ2□	—	3.3nH ±0.1nH	500MHz	450mA	0.25 Ω	14	500MHz	8000MHz
LQP03TN3N3CZ2□	—	3.3nH ±0.2nH	500MHz	450mA	0.25 Ω	14	500MHz	8000MHz
LQP03TN3N4BZ2□	—	3.4nH ±0.1nH	500MHz	450mA	0.25 Ω	14	500MHz	7000MHz
LQP03TN3N4CZ2□	—	3.4nH ±0.2nH	500MHz	450mA	0.25 Ω	14	500MHz	7000MHz
LQP03TN3N5BZ2□	—	3.5nH ±0.1nH	500MHz	450mA	0.25 Ω	14	500MHz	7000MHz
LQP03TN3N5CZ2□	—	3.5nH ±0.2nH	500MHz	450mA	0.25 Ω	14	500MHz	7000MHz
LQP03TN3N6BZ2□	—	3.6nH ±0.1nH	500MHz	400mA	0.30 Ω	14	500MHz	6000MHz
LQP03TN3N6CZ2□	—	3.6nH ±0.2nH	500MHz	400mA	0.30 Ω	14	500MHz	6000MHz
LQP03TN3N7BZ2□	—	3.7nH ±0.1nH	500MHz	400mA	0.30 Ω	14	500MHz	6000MHz
LQP03TN3N7CZ2□	—	3.7nH ±0.2nH	500MHz	400mA	0.30 Ω	14	500MHz	6000MHz
LQP03TN3N8BZ2□	—	3.8nH ±0.1nH	500MHz	400mA	0.30 Ω	14	500MHz	6000MHz
LQP03TN3N8CZ2□	—	3.8nH ±0.2nH	500MHz	400mA	0.30 Ω	14	500MHz	6000MHz
LQP03TN3N9BZ2□	—	3.9nH ±0.1nH	500MHz	400mA	0.30 Ω	14	500MHz	5700MHz
LQP03TN3N9CZ2□	—	3.9nH ±0.2nH	500MHz	400mA	0.30 Ω	14	500MHz	5700MHz
LQP03TN4N0BZ2□	—	4.0nH ±0.1nH	500MHz	350mA	0.40 Ω	14	500MHz	5300MHz
LQP03TN4N0CZ2□	—	4.0nH ±0.2nH	500MHz	350mA	0.40 Ω	14	500MHz	5300MHz
LQP03TN4N1BZ2□	—	4.1nH ±0.1nH	500MHz	350mA	0.40 Ω	14	500MHz	5300MHz
LQP03TN4N1CZ2□	—	4.1nH ±0.2nH	500MHz	350mA	0.40 Ω	14	500MHz	5300MHz
LQP03TN4N2BZ2□	—	4.2nH ±0.1nH	500MHz	350mA	0.40 Ω	14	500MHz	5300MHz
LQP03TN4N2CZ2□	—	4.2nH ±0.2nH	500MHz	350mA	0.40 Ω	14	500MHz	5300MHz
LQP03TN4N3HZ2□	—	4.3nH ±3%	500MHz	350mA	0.40 Ω	14	500MHz	5300MHz
LQP03TN4N3JZ2□	—	4.3nH ±5%	500MHz	350mA	0.40 Ω	14	500MHz	5300MHz
LQP03TN4N7HZ2□	—	4.7nH ±3%	500MHz	350mA	0.40 Ω	14	500MHz	4400MHz
LQP03TN4N7JZ2□	—	4.7nH ±5%	500MHz	350mA	0.40 Ω	14	500MHz	4400MHz
LQP03TN5N1HZ2□	—	5.1nH ±3%	500MHz	350mA	0.40 Ω	14	500MHz	4200MHz

Operating Temperature Range (Self-temperature rise is not included): -55°C~+125°C
For reflow soldering only.

Continued on the following page. 

△Note • Please read rating and △CAUTION (for storage, operating, rating, soldering, mounting and handling) in this catalog to prevent smoking and/or burning, etc.
• This catalog has only typical specifications. Therefore, please approve our product specifications or transact the approval sheet for product specifications before ordering.

Part Number		Inductance	Inductance Test Frequency	Rated Current	Max. of DC Resistance	Q (min.)	Q Test Frequency	Self-Resonance Frequency (min.)
For Infotainment	For Powertrain/Safety							
LQP03TN5N1JZ2□	—	5.1nH ±5%	500MHz	350mA	0.40 Ω	14	500MHz	4200MHz
LQP03TN5N6HZ2□	—	5.6nH ±3%	500MHz	350mA	0.40 Ω	14	500MHz	4000MHz
LQP03TN5N6JZ2□	—	5.6nH ±5%	500MHz	350mA	0.40 Ω	14	500MHz	4000MHz
LQP03TN6N2HZ2□	—	6.2nH ±3%	500MHz	300mA	0.60 Ω	14	500MHz	4000MHz
LQP03TN6N2JZ2□	—	6.2nH ±5%	500MHz	300mA	0.60 Ω	14	500MHz	4000MHz
LQP03TN6N8HZ2□	—	6.8nH ±3%	500MHz	300mA	0.60 Ω	14	500MHz	3900MHz
LQP03TN6N8JZ2□	—	6.8nH ±5%	500MHz	300mA	0.60 Ω	14	500MHz	3900MHz
LQP03TN7N5HZ2□	—	7.5nH ±3%	500MHz	300mA	0.60 Ω	14	500MHz	3700MHz
LQP03TN7N5JZ2□	—	7.5nH ±5%	500MHz	300mA	0.60 Ω	14	500MHz	3700MHz
LQP03TN8N2HZ2□	—	8.2nH ±3%	500MHz	250mA	0.70 Ω	14	500MHz	3600MHz
LQP03TN8N2JZ2□	—	8.2nH ±5%	500MHz	250mA	0.70 Ω	14	500MHz	3600MHz
LQP03TN9N1HZ2□	—	9.1nH ±3%	500MHz	250mA	0.70 Ω	14	500MHz	3300MHz
LQP03TN9N1JZ2□	—	9.1nH ±5%	500MHz	250mA	0.70 Ω	14	500MHz	3300MHz
LQP03TN10NHZ2□	—	10nH ±3%	500MHz	250mA	0.70 Ω	14	500MHz	3200MHz
LQP03TN10NJZ2□	—	10nH ±5%	500MHz	250mA	0.70 Ω	14	500MHz	3200MHz
LQP03TN11NHZ2□	—	11nH ±3%	500MHz	250mA	0.80 Ω	14	500MHz	2900MHz
LQP03TN11NJZ2□	—	11nH ±5%	500MHz	250mA	0.80 Ω	14	500MHz	2900MHz
LQP03TN12NHZ2□	—	12nH ±3%	500MHz	250mA	0.70 Ω	12	500MHz	2900MHz
LQP03TN12NJZ2□	—	12nH ±5%	500MHz	250mA	0.70 Ω	12	500MHz	2900MHz
LQP03TN13NHZ2□	—	13nH ±3%	500MHz	250mA	0.80 Ω	12	500MHz	2600MHz
LQP03TN13NJZ2□	—	13nH ±5%	500MHz	250mA	0.80 Ω	12	500MHz	2600MHz
LQP03TN15NHZ2□	—	15nH ±3%	500MHz	250mA	0.70 Ω	12	500MHz	2600MHz
LQP03TN15NJZ2□	—	15nH ±5%	500MHz	250mA	0.70 Ω	12	500MHz	2600MHz
LQP03TN16NHZ2□	—	16nH ±3%	500MHz	200mA	0.95 Ω	12	500MHz	2200MHz
LQP03TN16NJZ2□	—	16nH ±5%	500MHz	200mA	0.95 Ω	12	500MHz	2200MHz
LQP03TN18NHZ2□	—	18nH ±3%	500MHz	200mA	0.80 Ω	12	500MHz	2200MHz
LQP03TN18NJZ2□	—	18nH ±5%	500MHz	200mA	0.80 Ω	12	500MHz	2200MHz
LQP03TN20NHZ2□	—	20nH ±3%	500MHz	150mA	2.30 Ω	12	500MHz	2200MHz
LQP03TN20NJZ2□	—	20nH ±5%	500MHz	150mA	2.30 Ω	12	500MHz	2200MHz
LQP03TN22NHZ2□	—	22nH ±3%	500MHz	150mA	1.90 Ω	12	500MHz	2200MHz
LQP03TN22NJZ2□	—	22nH ±5%	500MHz	150mA	1.90 Ω	12	500MHz	2200MHz
LQP03TN24NHZ2□	—	24nH ±3%	500MHz	140mA	2.30 Ω	12	500MHz	2000MHz
LQP03TN24NJZ2□	—	24nH ±5%	500MHz	140mA	2.30 Ω	12	500MHz	2000MHz
LQP03TN27NHZ2□	—	27nH ±3%	500MHz	140mA	2.30 Ω	12	500MHz	2000MHz
LQP03TN27NJZ2□	—	27nH ±5%	500MHz	140mA	2.30 Ω	12	500MHz	2000MHz
LQP03TN30NHZ2□	—	30nH ±3%	500MHz	120mA	2.95 Ω	9	500MHz	1700MHz
LQP03TN30NJZ2□	—	30nH ±5%	500MHz	120mA	2.95 Ω	9	500MHz	1700MHz
LQP03TN33NHZ2□	—	33nH ±3%	300MHz	120mA	2.95 Ω	9	300MHz	1700MHz
LQP03TN33NJZ2□	—	33nH ±5%	300MHz	120mA	2.95 Ω	9	300MHz	1700MHz
LQP03TN36NHZ2□	—	36nH ±3%	300MHz	120mA	3.00 Ω	9	300MHz	1500MHz
LQP03TN36NJZ2□	—	36nH ±5%	300MHz	120mA	3.00 Ω	9	300MHz	1500MHz
LQP03TN39NHZ2□	—	39nH ±3%	300MHz	120mA	3.00 Ω	9	300MHz	1500MHz
LQP03TN39NJZ2□	—	39nH ±5%	300MHz	120mA	3.00 Ω	9	300MHz	1500MHz
LQP03TN43NHZ2□	—	43nH ±3%	300MHz	100mA	3.60 Ω	9	300MHz	1300MHz
LQP03TN43NJZ2□	—	43nH ±5%	300MHz	100mA	3.60 Ω	9	300MHz	1300MHz
LQP03TN47NHZ2□	—	47nH ±3%	300MHz	100mA	3.60 Ω	9	300MHz	1300MHz
LQP03TN47NJZ2□	—	47nH ±5%	300MHz	100mA	3.60 Ω	9	300MHz	1300MHz

Operating Temperature Range (Self-temperature rise is not included): -55°C~+125°C
For reflow soldering only.

Continued on the following page. 

△Note • Please read rating and △CAUTION (for storage, operating, rating, soldering, mounting and handling) in this catalog to prevent smoking and/or burning, etc.
• This catalog has only typical specifications. Therefore, please approve our product specifications or transact the approval sheet for product specifications before ordering.

Part Number		Inductance	Inductance Test Frequency	Rated Current	Max. of DC Resistance	Q (min.)	Q Test Frequency	Self-Resonance Frequency (min.)
For Infotainment	For Powertrain/Safety							
LQP03TN51NHZ2□	—	51nH ±3%	300MHz	100mA	3.90Ω	9	300MHz	1200MHz
LQP03TN51NJZ2□	—	51nH ±5%	300MHz	100mA	3.90Ω	9	300MHz	1200MHz
LQP03TN56NHZ2□	—	56nH ±3%	300MHz	100mA	3.90Ω	9	300MHz	1200MHz
LQP03TN56NJZ2□	—	56nH ±5%	300MHz	100mA	3.90Ω	9	300MHz	1200MHz
LQP03TN62NHZ2□	—	62nH ±3%	300MHz	100mA	8Ω	8	300MHz	1100MHz
LQP03TN62NJZ2□	—	62nH ±5%	300MHz	100mA	8Ω	8	300MHz	1100MHz
LQP03TN68NHZ2□	—	68nH ±3%	300MHz	100mA	8Ω	8	300MHz	1100MHz
LQP03TN68NJZ2□	—	68nH ±5%	300MHz	100mA	8Ω	8	300MHz	1100MHz
LQP03TN75NHZ2□	—	75nH ±3%	300MHz	100mA	10Ω	8	300MHz	1000MHz
LQP03TN75NJZ2□	—	75nH ±5%	300MHz	100mA	10Ω	8	300MHz	1000MHz
LQP03TN82NHZ2□	—	82nH ±3%	300MHz	100mA	10Ω	8	300MHz	1000MHz
LQP03TN82NJZ2□	—	82nH ±5%	300MHz	100mA	10Ω	8	300MHz	1000MHz
LQP03TN91NHZ2□	—	91nH ±3%	300MHz	80mA	10Ω	8	300MHz	900MHz
LQP03TN91NJZ2□	—	91nH ±5%	300MHz	80mA	10Ω	8	300MHz	900MHz
LQP03TNR10HZ2□	—	100nH ±3%	300MHz	80mA	10Ω	8	300MHz	900MHz
LQP03TNR10JZ2□	—	100nH ±5%	300MHz	80mA	10Ω	8	300MHz	900MHz
LQP03TNR11HZ2□	—	110nH ±3%	300MHz	80mA	12Ω	8	300MHz	800MHz
LQP03TNR11JZ2□	—	110nH ±5%	300MHz	80mA	12Ω	8	300MHz	800MHz
LQP03TNR12HZ2□	—	120nH ±3%	300MHz	80mA	12Ω	8	300MHz	800MHz
LQP03TNR12JZ2□	—	120nH ±5%	300MHz	80mA	12Ω	8	300MHz	800MHz

Operating Temperature Range (Self-temperature rise is not included): -55°C~+125°C
For reflow soldering only.

Inductors for Power Lines

Inductors for General Circuits

Film Type (Non-Magnetic Core)
RF Inductors

■ Q-Frequency Characteristics (Typ.)

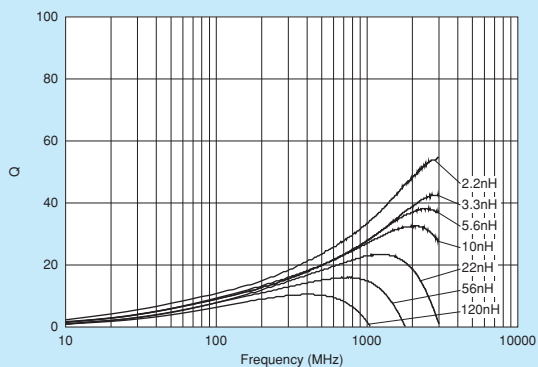

■ Inductance-Frequency Characteristics (Typ.)

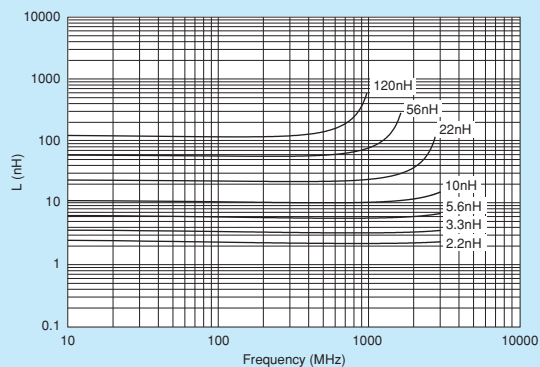

△Note • Please read rating and △CAUTION (for storage, operating, rating, soldering, mounting and handling) in this catalog to prevent smoking and/or burning, etc.
• This catalog has only typical specifications. Therefore, please approve our product specifications or transact the approval sheet for product specifications before ordering.

Wire Wound Type (Non-Magnetic Core)

LQW15AN_0Z Series 0402/1005 (inch/mm)

Size Code 0402 (1005) in inch (in mm), Wound Type

■ Appearance/Dimensions

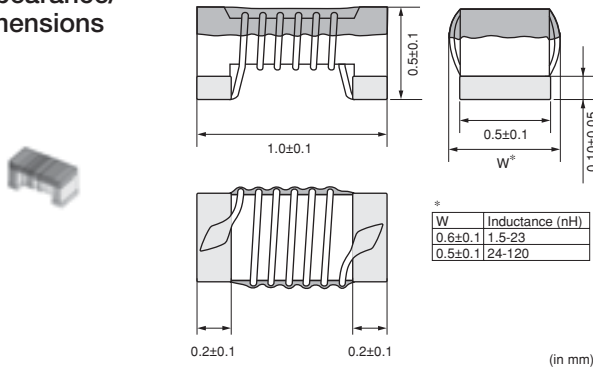

■ Packaging

Code	Packaging	Minimum Quantity
D	ø180mm Paper Taping	10000
B	Packing in Bulk	500



Refer to pages from p.230 to p.232 for mounting information.

■ Rated Value (□: packaging code)

Part Number		Inductance	Inductance Test Frequency	Rated Current	Max. of DC Resistance	Q (min.)	Q Test Frequency	Self-Resonance Frequency (min.)
For Infotainment	For Powertrain/Safety							
LQW15AN1N5B0Z□	—	1.5nH ±0.1nH	100MHz	1000mA	0.03Ω	10	250MHz	18.0GHz
LQW15AN1N5C0Z□	—	1.5nH ±0.2nH	100MHz	1000mA	0.03Ω	10	250MHz	18.0GHz
LQW15AN1N5D0Z□	—	1.5nH ±0.5nH	100MHz	1000mA	0.03Ω	10	250MHz	18.0GHz
LQW15AN1N6C0Z□	—	1.6nH ±0.2nH	100MHz	750mA	0.07Ω	10	250MHz	17.0GHz
LQW15AN1N6D0Z□	—	1.6nH ±0.5nH	100MHz	750mA	0.07Ω	10	250MHz	17.0GHz
LQW15AN1N7C0Z□	—	1.7nH ±0.2nH	100MHz	640mA	0.10Ω	10	250MHz	17.0GHz
LQW15AN1N7D0Z□	—	1.7nH ±0.5nH	100MHz	640mA	0.10Ω	10	250MHz	17.0GHz
LQW15AN1N8C0Z□	—	1.8nH ±0.2nH	100MHz	460mA	0.16Ω	10	250MHz	16.0GHz
LQW15AN1N8D0Z□	—	1.8nH ±0.5nH	100MHz	460mA	0.16Ω	10	250MHz	16.0GHz
LQW15AN2N4B0Z□	—	2.4nH ±0.1nH	100MHz	850mA	0.05Ω	20	250MHz	15.0GHz
LQW15AN2N4C0Z□	—	2.4nH ±0.2nH	100MHz	850mA	0.05Ω	20	250MHz	15.0GHz
LQW15AN2N4D0Z□	—	2.4nH ±0.5nH	100MHz	850mA	0.05Ω	20	250MHz	15.0GHz
LQW15AN2N5B0Z□	—	2.5nH ±0.1nH	100MHz	850mA	0.05Ω	20	250MHz	15.0GHz
LQW15AN2N5C0Z□	—	2.5nH ±0.2nH	100MHz	850mA	0.05Ω	20	250MHz	15.0GHz
LQW15AN2N5D0Z□	—	2.5nH ±0.5nH	100MHz	850mA	0.05Ω	20	250MHz	15.0GHz
LQW15AN2N6B0Z□	—	2.6nH ±0.1nH	100MHz	850mA	0.05Ω	20	250MHz	15.0GHz
LQW15AN2N6C0Z□	—	2.6nH ±0.2nH	100MHz	850mA	0.05Ω	20	250MHz	15.0GHz
LQW15AN2N6D0Z□	—	2.6nH ±0.5nH	100MHz	850mA	0.05Ω	20	250MHz	15.0GHz
LQW15AN2N7B0Z□	—	2.7nH ±0.1nH	100MHz	850mA	0.05Ω	20	250MHz	15.0GHz
LQW15AN2N7C0Z□	—	2.7nH ±0.2nH	100MHz	850mA	0.05Ω	20	250MHz	15.0GHz
LQW15AN2N7D0Z□	—	2.7nH ±0.5nH	100MHz	850mA	0.05Ω	20	250MHz	15.0GHz
LQW15AN2N8B0Z□	—	2.8nH ±0.1nH	100MHz	850mA	0.05Ω	20	250MHz	15.0GHz
LQW15AN2N8C0Z□	—	2.8nH ±0.2nH	100MHz	850mA	0.05Ω	20	250MHz	15.0GHz
LQW15AN2N8D0Z□	—	2.8nH ±0.5nH	100MHz	850mA	0.05Ω	20	250MHz	15.0GHz
LQW15AN2N9B0Z□	—	2.9nH ±0.1nH	100MHz	750mA	0.07Ω	20	250MHz	15.0GHz
LQW15AN2N9C0Z□	—	2.9nH ±0.2nH	100MHz	750mA	0.07Ω	20	250MHz	15.0GHz
LQW15AN2N9D0Z□	—	2.9nH ±0.5nH	100MHz	750mA	0.07Ω	20	250MHz	15.0GHz
LQW15AN3N0B0Z□	—	3.0nH ±0.1nH	100MHz	750mA	0.07Ω	20	250MHz	15.0GHz
LQW15AN3N0C0Z□	—	3.0nH ±0.2nH	100MHz	750mA	0.07Ω	20	250MHz	15.0GHz
LQW15AN3N0D0Z□	—	3.0nH ±0.5nH	100MHz	750mA	0.07Ω	20	250MHz	15.0GHz
LQW15AN3N1B0Z□	—	3.1nH ±0.1nH	100MHz	570mA	0.13Ω	20	250MHz	14.0GHz
LQW15AN3N1C0Z□	—	3.1nH ±0.2nH	100MHz	570mA	0.13Ω	20	250MHz	14.0GHz

Operating Temperature Range (Self-temperature rise is not included): -55°C~+125°C
For reflow soldering only.



Continued on the following page.

△Note • Please read rating and △CAUTION (for storage, operating, rating, soldering, mounting and handling) in this catalog to prevent smoking and/or burning, etc.
• This catalog has only typical specifications. Therefore, please approve our product specifications or transact the approval sheet for product specifications before ordering.

Part Number		Inductance	Inductance Test Frequency	Rated Current	Max. of DC Resistance	Q (min.)	Q Test Frequency	Self-Resonance Frequency (min.)
For Infotainment	For Powertrain/Safety							
LQW15AN3N1D0Z□	—	3.1nH ±0.5nH	100MHz	570mA	0.13Ω	20	250MHz	14.0GHz
LQW15AN3N2B0Z□	—	3.2nH ±0.1nH	100MHz	500mA	0.17Ω	15	250MHz	14.0GHz
LQW15AN3N2C0Z□	—	3.2nH ±0.2nH	100MHz	500mA	0.17Ω	15	250MHz	14.0GHz
LQW15AN3N2D0Z□	—	3.2nH ±0.5nH	100MHz	500mA	0.17Ω	15	250MHz	14.0GHz
LQW15AN3N9B0Z□	—	3.9nH ±0.1nH	100MHz	750mA	0.07Ω	25	250MHz	10.0GHz
LQW15AN3N9C0Z□	—	3.9nH ±0.2nH	100MHz	750mA	0.07Ω	25	250MHz	10.0GHz
LQW15AN3N9D0Z□	—	3.9nH ±0.5nH	100MHz	750mA	0.07Ω	25	250MHz	10.0GHz
LQW15AN4N1B0Z□	—	4.1nH ±0.1nH	100MHz	750mA	0.07Ω	25	250MHz	10.0GHz
LQW15AN4N1C0Z□	—	4.1nH ±0.2nH	100MHz	750mA	0.07Ω	25	250MHz	10.0GHz
LQW15AN4N1D0Z□	—	4.1nH ±0.5nH	100MHz	750mA	0.07Ω	25	250MHz	10.0GHz
LQW15AN4N3B0Z□	—	4.3nH ±0.1nH	100MHz	750mA	0.07Ω	25	250MHz	10.0GHz
LQW15AN4N3C0Z□	—	4.3nH ±0.2nH	100MHz	750mA	0.07Ω	25	250MHz	10.0GHz
LQW15AN4N3D0Z□	—	4.3nH ±0.5nH	100MHz	750mA	0.07Ω	25	250MHz	10.0GHz
LQW15AN4N4B0Z□	—	4.4nH ±0.1nH	100MHz	750mA	0.07Ω	25	250MHz	8.0GHz
LQW15AN4N4C0Z□	—	4.4nH ±0.2nH	100MHz	750mA	0.07Ω	25	250MHz	8.0GHz
LQW15AN4N4D0Z□	—	4.4nH ±0.5nH	100MHz	750mA	0.07Ω	25	250MHz	8.0GHz
LQW15AN4N5B0Z□	—	4.5nH ±0.1nH	100MHz	750mA	0.07Ω	25	250MHz	8.0GHz
LQW15AN4N5C0Z□	—	4.5nH ±0.2nH	100MHz	750mA	0.07Ω	25	250MHz	8.0GHz
LQW15AN4N5D0Z□	—	4.5nH ±0.5nH	100MHz	750mA	0.07Ω	25	250MHz	8.0GHz
LQW15AN4N6B0Z□	—	4.6nH ±0.1nH	100MHz	750mA	0.07Ω	25	250MHz	8.0GHz
LQW15AN4N6C0Z□	—	4.6nH ±0.2nH	100MHz	750mA	0.07Ω	25	250MHz	8.0GHz
LQW15AN4N6D0Z□	—	4.6nH ±0.5nH	100MHz	750mA	0.07Ω	25	250MHz	8.0GHz
LQW15AN4N7B0Z□	—	4.7nH ±0.1nH	100MHz	750mA	0.07Ω	25	250MHz	8.0GHz
LQW15AN4N7C0Z□	—	4.7nH ±0.2nH	100MHz	750mA	0.07Ω	25	250MHz	8.0GHz
LQW15AN4N7D0Z□	—	4.7nH ±0.5nH	100MHz	750mA	0.07Ω	25	250MHz	8.0GHz
LQW15AN4N8B0Z□	—	4.8nH ±0.1nH	100MHz	750mA	0.07Ω	25	250MHz	8.0GHz
LQW15AN4N8C0Z□	—	4.8nH ±0.2nH	100MHz	750mA	0.07Ω	25	250MHz	8.0GHz
LQW15AN4N8D0Z□	—	4.8nH ±0.5nH	100MHz	750mA	0.07Ω	25	250MHz	8.0GHz
LQW15AN4N9B0Z□	—	4.9nH ±0.1nH	100MHz	600mA	0.12Ω	25	250MHz	8.0GHz
LQW15AN4N9C0Z□	—	4.9nH ±0.2nH	100MHz	600mA	0.12Ω	25	250MHz	8.0GHz
LQW15AN4N9D0Z□	—	4.9nH ±0.5nH	100MHz	600mA	0.12Ω	25	250MHz	8.0GHz
LQW15AN5N0B0Z□	—	5.0nH ±0.1nH	100MHz	600mA	0.12Ω	25	250MHz	8.0GHz
LQW15AN5N0C0Z□	—	5.0nH ±0.2nH	100MHz	600mA	0.12Ω	25	250MHz	8.0GHz
LQW15AN5N0D0Z□	—	5.0nH ±0.5nH	100MHz	600mA	0.12Ω	25	250MHz	8.0GHz
LQW15AN5N1B0Z□	—	5.1nH ±0.1nH	100MHz	600mA	0.12Ω	25	250MHz	8.0GHz
LQW15AN5N1C0Z□	—	5.1nH ±0.2nH	100MHz	600mA	0.12Ω	25	250MHz	8.0GHz
LQW15AN5N1D0Z□	—	5.1nH ±0.5nH	100MHz	600mA	0.12Ω	25	250MHz	8.0GHz
LQW15AN5N8B0Z□	—	5.8nH ±0.1nH	100MHz	700mA	0.09Ω	25	250MHz	8.0GHz
LQW15AN5N8C0Z□	—	5.8nH ±0.2nH	100MHz	700mA	0.09Ω	25	250MHz	8.0GHz
LQW15AN5N8D0Z□	—	5.8nH ±0.5nH	100MHz	700mA	0.09Ω	25	250MHz	8.0GHz
LQW15AN6N2B0Z□	—	6.2nH ±0.1nH	100MHz	700mA	0.09Ω	25	250MHz	8.0GHz
LQW15AN6N2C0Z□	—	6.2nH ±0.2nH	100MHz	700mA	0.09Ω	25	250MHz	8.0GHz
LQW15AN6N2D0Z□	—	6.2nH ±0.5nH	100MHz	700mA	0.09Ω	25	250MHz	8.0GHz
LQW15AN6N3B0Z□	—	6.3nH ±0.1nH	100MHz	700mA	0.09Ω	25	250MHz	6.0GHz
LQW15AN6N3C0Z□	—	6.3nH ±0.2nH	100MHz	700mA	0.09Ω	25	250MHz	6.0GHz
LQW15AN6N3D0Z□	—	6.3nH ±0.5nH	100MHz	700mA	0.09Ω	25	250MHz	6.0GHz
LQW15AN6N4B0Z□	—	6.4nH ±0.1nH	100MHz	700mA	0.09Ω	25	250MHz	6.0GHz

Operating Temperature Range (Self-temperature rise is not included): -55°C~+125°C
For reflow soldering only.

Continued on the following page. 

 Note • Please read rating and  CAUTION (for storage, operating, rating, soldering, mounting and handling) in this catalog to prevent smoking and/or burning, etc.
• This catalog has only typical specifications. Therefore, please approve our product specifications or transact the approval sheet for product specifications before ordering.

Part Number		Inductance	Inductance Test Frequency	Rated Current	Max. of DC Resistance	Q (min.)	Q Test Frequency	Self-Resonance Frequency (min.)
For Infotainment	For Powertrain/Safety							
LQW15AN6N4C0Z□	—	6.4nH ±0.2nH	100MHz	700mA	0.09Ω	25	250MHz	6.0GHz
LQW15AN6N4D0Z□	—	6.4nH ±0.5nH	100MHz	700mA	0.09Ω	25	250MHz	6.0GHz
LQW15AN6N5B0Z□	—	6.5nH ±0.1nH	100MHz	700mA	0.09Ω	25	250MHz	6.0GHz
LQW15AN6N5C0Z□	—	6.5nH ±0.2nH	100MHz	700mA	0.09Ω	25	250MHz	6.0GHz
LQW15AN6N5D0Z□	—	6.5nH ±0.5nH	100MHz	700mA	0.09Ω	25	250MHz	6.0GHz
LQW15AN6N6B0Z□	—	6.6nH ±0.1nH	100MHz	700mA	0.09Ω	25	250MHz	6.0GHz
LQW15AN6N6C0Z□	—	6.6nH ±0.2nH	100MHz	700mA	0.09Ω	25	250MHz	6.0GHz
LQW15AN6N6D0Z□	—	6.6nH ±0.5nH	100MHz	700mA	0.09Ω	25	250MHz	6.0GHz
LQW15AN6N7B0Z□	—	6.7nH ±0.1nH	100MHz	700mA	0.09Ω	25	250MHz	6.0GHz
LQW15AN6N7C0Z□	—	6.7nH ±0.2nH	100MHz	700mA	0.09Ω	25	250MHz	6.0GHz
LQW15AN6N7D0Z□	—	6.7nH ±0.5nH	100MHz	700mA	0.09Ω	25	250MHz	6.0GHz
LQW15AN6N8G0Z□	—	6.8nH ±2%	100MHz	700mA	0.09Ω	25	250MHz	6.0GHz
LQW15AN6N8H0Z□	—	6.8nH ±3%	100MHz	700mA	0.09Ω	25	250MHz	6.0GHz
LQW15AN6N8J0Z□	—	6.8nH ±5%	100MHz	700mA	0.09Ω	25	250MHz	6.0GHz
LQW15AN6N9G0Z□	—	6.9nH ±2%	100MHz	570mA	0.13Ω	25	250MHz	6.0GHz
LQW15AN6N9H0Z□	—	6.9nH ±3%	100MHz	570mA	0.13Ω	25	250MHz	6.0GHz
LQW15AN6N9J0Z□	—	6.9nH ±5%	100MHz	570mA	0.13Ω	25	250MHz	6.0GHz
LQW15AN7N0G0Z□	—	7.0nH ±2%	100MHz	570mA	0.13Ω	25	250MHz	6.0GHz
LQW15AN7N0H0Z□	—	7.0nH ±3%	100MHz	570mA	0.13Ω	25	250MHz	6.0GHz
LQW15AN7N0J0Z□	—	7.0nH ±5%	100MHz	570mA	0.13Ω	25	250MHz	6.0GHz
LQW15AN7N1G0Z□	—	7.1nH ±2%	100MHz	570mA	0.13Ω	25	250MHz	6.0GHz
LQW15AN7N1H0Z□	—	7.1nH ±3%	100MHz	570mA	0.13Ω	25	250MHz	6.0GHz
LQW15AN7N1J0Z□	—	7.1nH ±5%	100MHz	570mA	0.13Ω	25	250MHz	6.0GHz
LQW15AN7N2G0Z□	—	7.2nH ±2%	100MHz	570mA	0.13Ω	25	250MHz	6.0GHz
LQW15AN7N2H0Z□	—	7.2nH ±3%	100MHz	570mA	0.13Ω	25	250MHz	6.0GHz
LQW15AN7N2J0Z□	—	7.2nH ±5%	100MHz	570mA	0.13Ω	25	250MHz	6.0GHz
LQW15AN7N3G0Z□	—	7.3nH ±2%	100MHz	570mA	0.13Ω	25	250MHz	6.0GHz
LQW15AN7N3H0Z□	—	7.3nH ±3%	100MHz	570mA	0.13Ω	25	250MHz	6.0GHz
LQW15AN7N3J0Z□	—	7.3nH ±5%	100MHz	570mA	0.13Ω	25	250MHz	6.0GHz
LQW15AN7N5G0Z□	—	7.5nH ±2%	100MHz	570mA	0.13Ω	30	250MHz	6.0GHz
LQW15AN7N5H0Z□	—	7.5nH ±3%	100MHz	570mA	0.13Ω	30	250MHz	6.0GHz
LQW15AN7N5J0Z□	—	7.5nH ±5%	100MHz	570mA	0.13Ω	30	250MHz	6.0GHz
LQW15AN8N2G0Z□	—	8.2nH ±2%	100MHz	540mA	0.14Ω	25	250MHz	5.5GHz
LQW15AN8N2H0Z□	—	8.2nH ±3%	100MHz	540mA	0.14Ω	25	250MHz	5.5GHz
LQW15AN8N2J0Z□	—	8.2nH ±5%	100MHz	540mA	0.14Ω	25	250MHz	5.5GHz
LQW15AN8N6G0Z□	—	8.6nH ±2%	100MHz	540mA	0.14Ω	25	250MHz	5.5GHz
LQW15AN8N6H0Z□	—	8.6nH ±3%	100MHz	540mA	0.14Ω	25	250MHz	5.5GHz
LQW15AN8N6J0Z□	—	8.6nH ±5%	100MHz	540mA	0.14Ω	25	250MHz	5.5GHz
LQW15AN8N7G0Z□	—	8.7nH ±2%	100MHz	540mA	0.14Ω	25	250MHz	5.5GHz
LQW15AN8N7H0Z□	—	8.7nH ±3%	100MHz	540mA	0.14Ω	25	250MHz	5.5GHz
LQW15AN8N7J0Z□	—	8.7nH ±5%	100MHz	540mA	0.14Ω	25	250MHz	5.5GHz
LQW15AN8N8G0Z□	—	8.8nH ±2%	100MHz	540mA	0.14Ω	25	250MHz	5.5GHz
LQW15AN8N8H0Z□	—	8.8nH ±3%	100MHz	540mA	0.14Ω	25	250MHz	5.5GHz
LQW15AN8N8J0Z□	—	8.8nH ±5%	100MHz	540mA	0.14Ω	25	250MHz	5.5GHz
LQW15AN8N9G0Z□	—	8.9nH ±2%	100MHz	540mA	0.14Ω	25	250MHz	5.5GHz
LQW15AN8N9H0Z□	—	8.9nH ±3%	100MHz	540mA	0.14Ω	25	250MHz	5.5GHz
LQW15AN8N9J0Z□	—	8.9nH ±5%	100MHz	540mA	0.14Ω	25	250MHz	5.5GHz

Operating Temperature Range (Self-temperature rise is not included): -55°C~+125°C
For reflow soldering only.

Continued on the following page. 

△Note • Please read rating and △CAUTION (for storage, operating, rating, soldering, mounting and handling) in this catalog to prevent smoking and/or burning, etc.
• This catalog has only typical specifications. Therefore, please approve our product specifications or transact the approval sheet for product specifications before ordering.

Part Number		Inductance	Inductance Test Frequency	Rated Current	Max. of DC Resistance	Q (min.)	Q Test Frequency	Self-Resonance Frequency (min.)
For Infotainment	For Powertrain/Safety							
LQW15AN9N0G0Z□	—	9.0nH ±2%	100MHz	540mA	0.14 Ω	25	250MHz	5.5GHz
LQW15AN9N0H0Z□	—	9.0nH ±3%	100MHz	540mA	0.14 Ω	25	250MHz	5.5GHz
LQW15AN9N0J0Z□	—	9.0nH ±5%	100MHz	540mA	0.14 Ω	25	250MHz	5.5GHz
LQW15AN9N1G0Z□	—	9.1nH ±2%	100MHz	540mA	0.14 Ω	30	250MHz	5.5GHz
LQW15AN9N1H0Z□	—	9.1nH ±3%	100MHz	540mA	0.14 Ω	30	250MHz	5.5GHz
LQW15AN9N1J0Z□	—	9.1nH ±5%	100MHz	540mA	0.14 Ω	30	250MHz	5.5GHz
LQW15AN9N2G0Z□	—	9.2nH ±2%	100MHz	540mA	0.14 Ω	25	250MHz	5.5GHz
LQW15AN9N2H0Z□	—	9.2nH ±3%	100MHz	540mA	0.14 Ω	25	250MHz	5.5GHz
LQW15AN9N2J0Z□	—	9.2nH ±5%	100MHz	540mA	0.14 Ω	25	250MHz	5.5GHz
LQW15AN9N3G0Z□	—	9.3nH ±2%	100MHz	540mA	0.14 Ω	25	250MHz	5.5GHz
LQW15AN9N3H0Z□	—	9.3nH ±3%	100MHz	540mA	0.14 Ω	25	250MHz	5.5GHz
LQW15AN9N3J0Z□	—	9.3nH ±5%	100MHz	540mA	0.14 Ω	25	250MHz	5.5GHz
LQW15AN9N4G0Z□	—	9.4nH ±2%	100MHz	540mA	0.14 Ω	25	250MHz	5.5GHz
LQW15AN9N4H0Z□	—	9.4nH ±3%	100MHz	540mA	0.14 Ω	25	250MHz	5.5GHz
LQW15AN9N4J0Z□	—	9.4nH ±5%	100MHz	540mA	0.14 Ω	25	250MHz	5.5GHz
LQW15AN9N5G0Z□	—	9.5nH ±2%	100MHz	540mA	0.14 Ω	25	250MHz	5.5GHz
LQW15AN9N5H0Z□	—	9.5nH ±3%	100MHz	540mA	0.14 Ω	25	250MHz	5.5GHz
LQW15AN9N5J0Z□	—	9.5nH ±5%	100MHz	540mA	0.14 Ω	25	250MHz	5.5GHz
LQW15AN9N6G0Z□	—	9.6nH ±2%	100MHz	540mA	0.14 Ω	25	250MHz	5.5GHz
LQW15AN9N6H0Z□	—	9.6nH ±3%	100MHz	540mA	0.14 Ω	25	250MHz	5.5GHz
LQW15AN9N6J0Z□	—	9.6nH ±5%	100MHz	540mA	0.14 Ω	25	250MHz	5.5GHz
LQW15AN9N7G0Z□	—	9.7nH ±2%	100MHz	540mA	0.14 Ω	25	250MHz	5.5GHz
LQW15AN9N7H0Z□	—	9.7nH ±3%	100MHz	540mA	0.14 Ω	25	250MHz	5.5GHz
LQW15AN9N7J0Z□	—	9.7nH ±5%	100MHz	540mA	0.14 Ω	25	250MHz	5.5GHz
LQW15AN9N8G0Z□	—	9.8nH ±2%	100MHz	540mA	0.14 Ω	25	250MHz	5.5GHz
LQW15AN9N8H0Z□	—	9.8nH ±3%	100MHz	540mA	0.14 Ω	25	250MHz	5.5GHz
LQW15AN9N8J0Z□	—	9.8nH ±5%	100MHz	540mA	0.14 Ω	25	250MHz	5.5GHz
LQW15AN9N9G0Z□	—	9.9nH ±2%	100MHz	540mA	0.14 Ω	25	250MHz	5.5GHz
LQW15AN9N9H0Z□	—	9.9nH ±3%	100MHz	540mA	0.14 Ω	25	250MHz	5.5GHz
LQW15AN9N9J0Z□	—	9.9nH ±5%	100MHz	540mA	0.14 Ω	25	250MHz	5.5GHz
LQW15AN10NG0Z□	—	10nH ±2%	100MHz	500mA	0.17 Ω	25	250MHz	5.5GHz
LQW15AN10NH0Z□	—	10nH ±3%	100MHz	500mA	0.17 Ω	25	250MHz	5.5GHz
LQW15AN10NJ0Z□	—	10nH ±5%	100MHz	500mA	0.17 Ω	25	250MHz	5.5GHz
LQW15AN11NG0Z□	—	11nH ±2%	100MHz	500mA	0.14 Ω	30	250MHz	5.5GHz
LQW15AN11NH0Z□	—	11nH ±3%	100MHz	500mA	0.14 Ω	30	250MHz	5.5GHz
LQW15AN11NJ0Z□	—	11nH ±5%	100MHz	500mA	0.14 Ω	30	250MHz	5.5GHz
LQW15AN12NG0Z□	—	12nH ±2%	100MHz	500mA	0.14 Ω	30	250MHz	5.5GHz
LQW15AN12NH0Z□	—	12nH ±3%	100MHz	500mA	0.14 Ω	30	250MHz	5.5GHz
LQW15AN12NJ0Z□	—	12nH ±5%	100MHz	500mA	0.14 Ω	30	250MHz	5.5GHz
LQW15AN13NG0Z□	—	13nH ±2%	100MHz	430mA	0.21 Ω	25	250MHz	5.0GHz
LQW15AN13NH0Z□	—	13nH ±3%	100MHz	430mA	0.21 Ω	25	250MHz	5.0GHz
LQW15AN13NJ0Z□	—	13nH ±5%	100MHz	430mA	0.21 Ω	25	250MHz	5.0GHz
LQW15AN15NG0Z□	—	15nH ±2%	100MHz	460mA	0.16 Ω	30	250MHz	5.0GHz
LQW15AN15NH0Z□	—	15nH ±3%	100MHz	460mA	0.16 Ω	30	250MHz	5.0GHz
LQW15AN15NJ0Z□	—	15nH ±5%	100MHz	460mA	0.16 Ω	30	250MHz	5.0GHz
LQW15AN16NG0Z□	—	16nH ±2%	100MHz	370mA	0.24 Ω	25	250MHz	4.5GHz
LQW15AN16NH0Z□	—	16nH ±3%	100MHz	370mA	0.24 Ω	25	250MHz	4.5GHz

Operating Temperature Range (Self-temperature rise is not included): -55°C~+125°C
For reflow soldering only.

Continued on the following page. 

△Note • Please read rating and △CAUTION (for storage, operating, rating, soldering, mounting and handling) in this catalog to prevent smoking and/or burning, etc.
• This catalog has only typical specifications. Therefore, please approve our product specifications or transact the approval sheet for product specifications before ordering.

Part Number		Inductance	Inductance Test Frequency	Rated Current	Max. of DC Resistance	Q (min.)	Q Test Frequency	Self-Resonance Frequency (min.)
For Infotainment	For Powertrain/Safety							
LQW15AN16NJ0Z□	—	16nH ±5%	100MHz	370mA	0.24 Ω	25	250MHz	4.5GHz
LQW15AN18NG0Z□	—	18nH ±2%	100MHz	370mA	0.27 Ω	25	250MHz	4.5GHz
LQW15AN18NH0Z□	—	18nH ±3%	100MHz	370mA	0.27 Ω	25	250MHz	4.5GHz
LQW15AN18NJ0Z□	—	18nH ±5%	100MHz	370mA	0.27 Ω	25	250MHz	4.5GHz
LQW15AN19NG0Z□	—	19nH ±2%	100MHz	370mA	0.27 Ω	25	250MHz	4.5GHz
LQW15AN19NH0Z□	—	19nH ±3%	100MHz	370mA	0.27 Ω	25	250MHz	4.5GHz
LQW15AN19NJ0Z□	—	19nH ±5%	100MHz	370mA	0.27 Ω	25	250MHz	4.5GHz
LQW15AN20NG0Z□	—	20nH ±2%	100MHz	370mA	0.27 Ω	25	250MHz	4.0GHz
LQW15AN20NH0Z□	—	20nH ±3%	100MHz	370mA	0.27 Ω	25	250MHz	4.0GHz
LQW15AN20NJ0Z□	—	20nH ±5%	100MHz	370mA	0.27 Ω	25	250MHz	4.0GHz
LQW15AN22NG0Z□	—	22nH ±2%	100MHz	310mA	0.30 Ω	25	250MHz	4.0GHz
LQW15AN22NH0Z□	—	22nH ±3%	100MHz	310mA	0.30 Ω	25	250MHz	4.0GHz
LQW15AN22NJ0Z□	—	22nH ±5%	100MHz	310mA	0.30 Ω	25	250MHz	4.0GHz
LQW15AN23NG0Z□	—	23nH ±2%	100MHz	310mA	0.30 Ω	25	250MHz	3.8GHz
LQW15AN23NH0Z□	—	23nH ±3%	100MHz	310mA	0.30 Ω	25	250MHz	3.8GHz
LQW15AN23NJ0Z□	—	23nH ±5%	100MHz	310mA	0.30 Ω	25	250MHz	3.8GHz
LQW15AN24NG0Z□	—	24nH ±2%	100MHz	280mA	0.52 Ω	25	250MHz	3.5GHz
LQW15AN24NH0Z□	—	24nH ±3%	100MHz	280mA	0.52 Ω	25	250MHz	3.5GHz
LQW15AN24NJ0Z□	—	24nH ±5%	100MHz	280mA	0.52 Ω	25	250MHz	3.5GHz
LQW15AN27NG0Z□	—	27nH ±2%	100MHz	280mA	0.52 Ω	25	250MHz	3.5GHz
LQW15AN27NH0Z□	—	27nH ±3%	100MHz	280mA	0.52 Ω	25	250MHz	3.5GHz
LQW15AN27NJ0Z□	—	27nH ±5%	100MHz	280mA	0.52 Ω	25	250MHz	3.5GHz
LQW15AN30NG0Z□	—	30nH ±2%	100MHz	270mA	0.58 Ω	25	250MHz	3.3GHz
LQW15AN30NH0Z□	—	30nH ±3%	100MHz	270mA	0.58 Ω	25	250MHz	3.3GHz
LQW15AN30NJ0Z□	—	30nH ±5%	100MHz	270mA	0.58 Ω	25	250MHz	3.3GHz
LQW15AN33NG0Z□	—	33nH ±2%	100MHz	260mA	0.63 Ω	25	250MHz	3.2GHz
LQW15AN33NH0Z□	—	33nH ±3%	100MHz	260mA	0.63 Ω	25	250MHz	3.2GHz
LQW15AN33NJ0Z□	—	33nH ±5%	100MHz	260mA	0.63 Ω	25	250MHz	3.2GHz
LQW15AN36NG0Z□	—	36nH ±2%	100MHz	260mA	0.63 Ω	25	250MHz	3.1GHz
LQW15AN36NH0Z□	—	36nH ±3%	100MHz	260mA	0.63 Ω	25	250MHz	3.1GHz
LQW15AN36NJ0Z□	—	36nH ±5%	100MHz	260mA	0.63 Ω	25	250MHz	3.1GHz
LQW15AN39NG0Z□	—	39nH ±2%	100MHz	250mA	0.70 Ω	25	250MHz	3.0GHz
LQW15AN39NH0Z□	—	39nH ±3%	100MHz	250mA	0.70 Ω	25	250MHz	3.0GHz
LQW15AN39NJ0Z□	—	39nH ±5%	100MHz	250mA	0.70 Ω	25	250MHz	3.0GHz
LQW15AN40NG0Z□	—	40nH ±2%	100MHz	250mA	0.70 Ω	25	250MHz	3.0GHz
LQW15AN40NH0Z□	—	40nH ±3%	100MHz	250mA	0.70 Ω	25	250MHz	3.0GHz
LQW15AN40NJ0Z□	—	40nH ±5%	100MHz	250mA	0.70 Ω	25	250MHz	3.0GHz
LQW15AN43NG0Z□	—	43nH ±2%	100MHz	250mA	0.70 Ω	25	250MHz	3.0GHz
LQW15AN43NH0Z□	—	43nH ±3%	100MHz	250mA	0.70 Ω	25	250MHz	3.0GHz
LQW15AN43NJ0Z□	—	43nH ±5%	100MHz	250mA	0.70 Ω	25	250MHz	3.0GHz
LQW15AN47NG0Z□	—	47nH ±2%	100MHz	210mA	1.08 Ω	25	200MHz	2.9GHz
LQW15AN47NH0Z□	—	47nH ±3%	100MHz	210mA	1.08 Ω	25	200MHz	2.9GHz
LQW15AN47NJ0Z□	—	47nH ±5%	100MHz	210mA	1.08 Ω	25	200MHz	2.9GHz
LQW15AN51NG0Z□	—	51nH ±2%	100MHz	210mA	1.08 Ω	25	200MHz	2.85GHz
LQW15AN51NH0Z□	—	51nH ±3%	100MHz	210mA	1.08 Ω	25	200MHz	2.85GHz
LQW15AN51NJ0Z□	—	51nH ±5%	100MHz	210mA	1.08 Ω	25	200MHz	2.85GHz
LQW15AN56NG0Z□	—	56nH ±2%	100MHz	200mA	1.17 Ω	25	200MHz	2.8GHz

Operating Temperature Range (Self-temperature rise is not included): -55°C~+125°C
For reflow soldering only.

Continued on the following page. 

△Note • Please read rating and △CAUTION (for storage, operating, rating, soldering, mounting and handling) in this catalog to prevent smoking and/or burning, etc.
• This catalog has only typical specifications. Therefore, please approve our product specifications or transact the approval sheet for product specifications before ordering.

Part Number		Inductance	Inductance Test Frequency	Rated Current	Max. of DC Resistance	Q (min.)	Q Test Frequency	Self-Resonance Frequency (min.)
For Infotainment	For Powertrain/Safety							
LQW15AN56NH0Z□	—	56nH ±3%	100MHz	200mA	1.17Ω	25	200MHz	2.8GHz
LQW15AN56NJ0Z□	—	56nH ±5%	100MHz	200mA	1.17Ω	25	200MHz	2.8GHz
LQW15AN62NG0Z□	—	62nH ±2%	100MHz	145mA	1.82Ω	20	200MHz	2.6GHz
LQW15AN62NH0Z□	—	62nH ±3%	100MHz	145mA	1.82Ω	20	200MHz	2.6GHz
LQW15AN62NJ0Z□	—	62nH ±5%	100MHz	145mA	1.82Ω	20	200MHz	2.6GHz
LQW15AN68NG0Z□	—	68nH ±2%	100MHz	140mA	1.96Ω	20	200MHz	2.5GHz
LQW15AN68NJ0Z□	—	68nH ±5%	100MHz	140mA	1.96Ω	20	200MHz	2.5GHz
LQW15AN72NG0Z□	—	72nH ±2%	100MHz	135mA	2.10Ω	20	150MHz	2.5GHz
LQW15AN72NJ0Z□	—	72nH ±5%	100MHz	135mA	2.10Ω	20	150MHz	2.5GHz
LQW15AN75NG0Z□	—	75nH ±2%	100MHz	135mA	2.10Ω	20	150MHz	2.4GHz
LQW15AN75NJ0Z□	—	75nH ±5%	100MHz	135mA	2.10Ω	20	150MHz	2.4GHz
LQW15AN82NG0Z□	—	82nH ±2%	100MHz	130mA	2.24Ω	20	150MHz	2.3GHz
LQW15AN82NJ0Z□	—	82nH ±5%	100MHz	130mA	2.24Ω	20	150MHz	2.3GHz
LQW15AN91NG0Z□	—	91nH ±2%	100MHz	125mA	2.38Ω	20	150MHz	2.1GHz
LQW15AN91NJ0Z□	—	91nH ±5%	100MHz	125mA	2.38Ω	20	150MHz	2.1GHz
LQW15ANR10J0Z□	—	100nH ±5%	100MHz	120mA	2.52Ω	20	150MHz	1.5GHz
LQW15ANR12J0Z□	—	120nH ±5%	100MHz	110mA	2.66Ω	20	150MHz	1.0GHz

Operating Temperature Range (Self-temperature rise is not included): -55°C~+125°C
For reflow soldering only.

■ Q-Frequency Characteristics (Typ.)

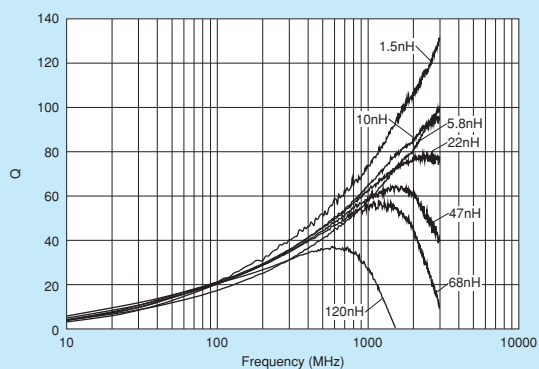

■ Inductance-Frequency Characteristics (Typ.)

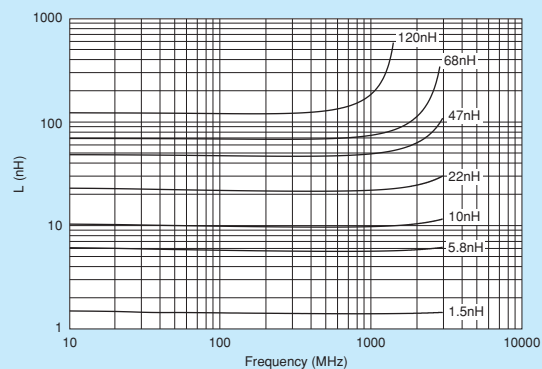

Continued on the following page.

△Note • Please read rating and △CAUTION (for storage, operating, rating, soldering, mounting and handling) in this catalog to prevent smoking and/or burning, etc.
• This catalog has only typical specifications. Therefore, please approve our product specifications or transact the approval sheet for product specifications before ordering.

Wire Wound Type (Non-Magnetic Core)

LQW15AN_1Z Series 0402/1005 (inch/mm)

Size Code 0402 (1005) in inch (in mm), High Q, Low DC Resistance Type

■ Appearance/Dimensions

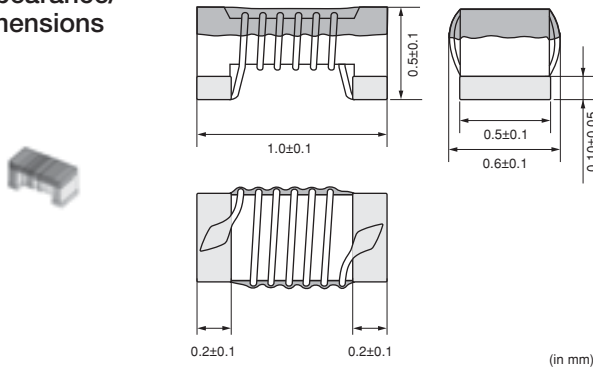

■ Packaging

Code	Packaging	Minimum Quantity
D	ø180mm Paper Taping	10000
B	Packing in Bulk	500



Refer to pages from p.230 to p.232 for mounting information.

■ Rated Value (□: packaging code)

Part Number		Inductance	Inductance Test Frequency	Rated Current	Max. of DC Resistance	Q (min.)	Q Test Frequency	Self-Resonance Frequency (min.)
For Infotainment	For Powertrain/Safety							
LQW15AN1N3C1Z□	—	1.3nH ±0.2nH	100MHz	1200mA	0.017Ω	20	250MHz	16GHz
LQW15AN1N3D1Z□	—	1.3nH ±0.5nH	100MHz	1200mA	0.017Ω	20	250MHz	16GHz
LQW15AN1N4C1Z□	—	1.4nH ±0.2nH	100MHz	1100mA	0.019Ω	25	250MHz	15GHz
LQW15AN1N4D1Z□	—	1.4nH ±0.5nH	100MHz	1100mA	0.019Ω	25	250MHz	15GHz
LQW15AN2N2C1Z□	—	2.2nH ±0.2nH	100MHz	1000mA	0.027Ω	25	250MHz	14GHz
LQW15AN2N2D1Z□	—	2.2nH ±0.5nH	100MHz	1000mA	0.027Ω	25	250MHz	14GHz
LQW15AN2N3C1Z□	—	2.3nH ±0.2nH	100MHz	1000mA	0.027Ω	25	250MHz	14GHz
LQW15AN2N3D1Z□	—	2.3nH ±0.5nH	100MHz	1000mA	0.027Ω	25	250MHz	14GHz
LQW15AN2N4D1Z□	—	2.4nH ±0.5nH	100MHz	1000mA	0.027Ω	25	250MHz	14GHz
LQW15AN3N3D1Z□	—	3.3nH ±0.5nH	100MHz	900mA	0.040Ω	30	250MHz	12GHz
LQW15AN3N4C1Z□	—	3.4nH ±0.2nH	100MHz	900mA	0.040Ω	30	250MHz	12GHz
LQW15AN3N4D1Z□	—	3.4nH ±0.5nH	100MHz	900mA	0.040Ω	30	250MHz	12GHz
LQW15AN3N5C1Z□	—	3.5nH ±0.2nH	100MHz	900mA	0.040Ω	30	250MHz	9.5GHz
LQW15AN3N5D1Z□	—	3.5nH ±0.5nH	100MHz	900mA	0.040Ω	30	250MHz	9.5GHz
LQW15AN3N6C1Z□	—	3.6nH ±0.2nH	100MHz	900mA	0.040Ω	30	250MHz	9.5GHz
LQW15AN3N6D1Z□	—	3.6nH ±0.5nH	100MHz	900mA	0.040Ω	30	250MHz	9.5GHz
LQW15AN3N8C1Z□	—	3.8nH ±0.2nH	100MHz	900mA	0.040Ω	30	250MHz	7GHz
LQW15AN3N8D1Z□	—	3.8nH ±0.5nH	100MHz	900mA	0.040Ω	30	250MHz	7GHz
LQW15AN3N9D1Z□	—	3.9nH ±0.5nH	100MHz	900mA	0.040Ω	30	250MHz	7GHz
LQW15AN4N0C1Z□	—	4.0nH ±0.2nH	100MHz	800mA	0.051Ω	30	250MHz	6.5GHz
LQW15AN4N0D1Z□	—	4.0nH ±0.5nH	100MHz	800mA	0.051Ω	30	250MHz	6.5GHz
LQW15AN4N2C1Z□	—	4.2nH ±0.2nH	100MHz	800mA	0.051Ω	30	250MHz	6.5GHz
LQW15AN4N2D1Z□	—	4.2nH ±0.5nH	100MHz	800mA	0.051Ω	30	250MHz	6.5GHz
LQW15AN4N7D1Z□	—	4.7nH ±0.5nH	100MHz	800mA	0.051Ω	30	250MHz	8GHz
LQW15AN5N1C1Z□	—	5.1nH ±0.2nH	100MHz	800mA	0.051Ω	30	250MHz	8GHz
LQW15AN5N1D1Z□	—	5.1nH ±0.5nH	100MHz	800mA	0.051Ω	30	250MHz	8GHz
LQW15AN5N2C1Z□	—	5.2nH ±0.2nH	100MHz	800mA	0.051Ω	30	250MHz	8GHz
LQW15AN5N2D1Z□	—	5.2nH ±0.5nH	100MHz	800mA	0.051Ω	30	250MHz	8GHz
LQW15AN5N3C1Z□	—	5.3nH ±0.2nH	100MHz	800mA	0.051Ω	30	250MHz	8GHz
LQW15AN5N3D1Z□	—	5.3nH ±0.5nH	100MHz	800mA	0.051Ω	30	250MHz	8GHz
LQW15AN5N4C1Z□	—	5.4nH ±0.2nH	100MHz	800mA	0.051Ω	30	250MHz	8GHz
LQW15AN5N4D1Z□	—	5.4nH ±0.5nH	100MHz	800mA	0.051Ω	30	250MHz	8GHz

Operating Temperature Range (Self-temperature rise is not included): -55°C~+125°C
For reflow soldering only.

Continued on the following page.

△Note • Please read rating and △CAUTION (for storage, operating, rating, soldering, mounting and handling) in this catalog to prevent smoking and/or burning, etc.
• This catalog has only typical specifications. Therefore, please approve our product specifications or transact the approval sheet for product specifications before ordering.

Part Number		Inductance	Inductance Test Frequency	Rated Current	Max. of DC Resistance	Q (min.)	Q Test Frequency	Self-Resonance Frequency (min.)
For Infotainment	For Powertrain/Safety							
LQW15AN5N5C1Z□	—	5.5nH ±0.2nH	100MHz	800mA	0.051Ω	30	250MHz	8GHz
LQW15AN5N5D1Z□	—	5.5nH ±0.5nH	100MHz	800mA	0.051Ω	30	250MHz	8GHz
LQW15AN5N6C1Z□	—	5.6nH ±0.2nH	100MHz	800mA	0.051Ω	30	250MHz	8GHz
LQW15AN5N6D1Z□	—	5.6nH ±0.5nH	100MHz	800mA	0.051Ω	30	250MHz	8GHz
LQW15AN5N7C1Z□	—	5.7nH ±0.2nH	100MHz	800mA	0.051Ω	30	250MHz	8GHz
LQW15AN5N7D1Z□	—	5.7nH ±0.5nH	100MHz	800mA	0.051Ω	30	250MHz	8GHz
LQW15AN5N9C1Z□	—	5.9nH ±0.2nH	100MHz	760mA	0.056Ω	30	250MHz	7.7GHz
LQW15AN5N9D1Z□	—	5.9nH ±0.5nH	100MHz	760mA	0.056Ω	30	250MHz	7.7GHz
LQW15AN6N0C1Z□	—	6.0nH ±0.2nH	100MHz	760mA	0.056Ω	30	250MHz	7.7GHz
LQW15AN6N0D1Z□	—	6.0nH ±0.5nH	100MHz	760mA	0.056Ω	30	250MHz	7.7GHz
LQW15AN6N1C1Z□	—	6.1nH ±0.2nH	100MHz	760mA	0.056Ω	30	250MHz	7.7GHz
LQW15AN6N1D1Z□	—	6.1nH ±0.5nH	100MHz	760mA	0.056Ω	30	250MHz	7.7GHz
LQW15AN7N4C1Z□	—	7.4nH ±0.2nH	100MHz	750mA	0.058Ω	30	250MHz	6.8GHz
LQW15AN7N4D1Z□	—	7.4nH ±0.5nH	100MHz	750mA	0.058Ω	30	250MHz	6.8GHz
LQW15AN7N6C1Z□	—	7.6nH ±0.2nH	100MHz	750mA	0.058Ω	30	250MHz	6.8GHz
LQW15AN7N6D1Z□	—	7.6nH ±0.5nH	100MHz	750mA	0.058Ω	30	250MHz	6.8GHz
LQW15AN7N7C1Z□	—	7.7nH ±0.2nH	100MHz	750mA	0.058Ω	30	250MHz	6.8GHz
LQW15AN7N7D1Z□	—	7.7nH ±0.5nH	100MHz	750mA	0.058Ω	30	250MHz	6.8GHz
LQW15AN7N8C1Z□	—	7.8nH ±0.2nH	100MHz	750mA	0.058Ω	30	250MHz	6.8GHz
LQW15AN7N8D1Z□	—	7.8nH ±0.5nH	100MHz	750mA	0.058Ω	30	250MHz	6.8GHz
LQW15AN7N9C1Z□	—	7.9nH ±0.2nH	100MHz	640mA	0.079Ω	30	250MHz	7.5GHz
LQW15AN7N9D1Z□	—	7.9nH ±0.5nH	100MHz	640mA	0.079Ω	30	250MHz	7.5GHz
LQW15AN8N0C1Z□	—	8.0nH ±0.2nH	100MHz	640mA	0.079Ω	30	250MHz	7.5GHz
LQW15AN8N0D1Z□	—	8.0nH ±0.5nH	100MHz	640mA	0.079Ω	30	250MHz	7.5GHz
LQW15AN8N1C1Z□	—	8.1nH ±0.2nH	100MHz	640mA	0.079Ω	30	250MHz	7.5GHz
LQW15AN8N1D1Z□	—	8.1nH ±0.5nH	100MHz	640mA	0.079Ω	30	250MHz	7.5GHz
LQW15AN8N3C1Z□	—	8.3nH ±0.2nH	100MHz	640mA	0.079Ω	30	250MHz	7.5GHz
LQW15AN8N3D1Z□	—	8.3nH ±0.5nH	100MHz	640mA	0.079Ω	30	250MHz	7.5GHz
LQW15AN8N4C1Z□	—	8.4nH ±0.2nH	100MHz	640mA	0.079Ω	30	250MHz	7.5GHz
LQW15AN8N4D1Z□	—	8.4nH ±0.5nH	100MHz	640mA	0.079Ω	30	250MHz	7.5GHz

Operating Temperature Range (Self-temperature rise is not included): -55°C~+125°C
 For reflow soldering only.

■ Q-Frequency Characteristics (Typ.)

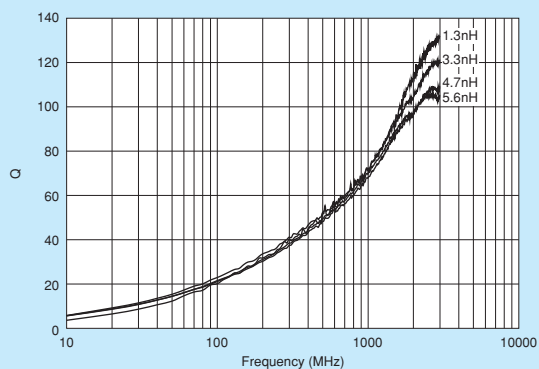

■ Inductance-Frequency Characteristics (Typ.)

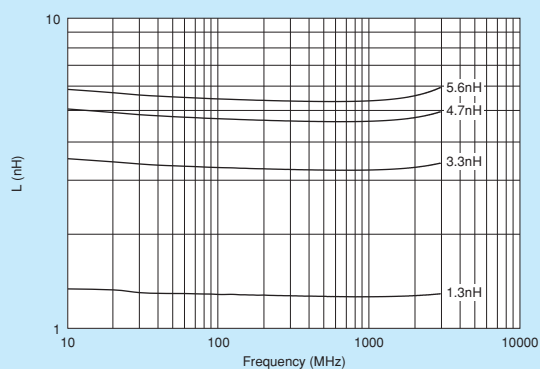

△Note • Please read rating and △CAUTION (for storage, operating, rating, soldering, mounting and handling) in this catalog to prevent smoking and/or burning, etc.
 • This catalog has only typical specifications. Therefore, please approve our product specifications or transact the approval sheet for product specifications before ordering.

Inductors for Power Lines
 Inductors for General Circuits
 Wire Wound Type (Non-Magnetic Core)
 RF Inductors

Wire Wound Type (Non-Magnetic Core)

LQW18AN_0Z Series 0603/1608 (inch/mm)

Size Code 0603 (1608) in inch (in mm), Wound Type

■ Appearance/Dimensions

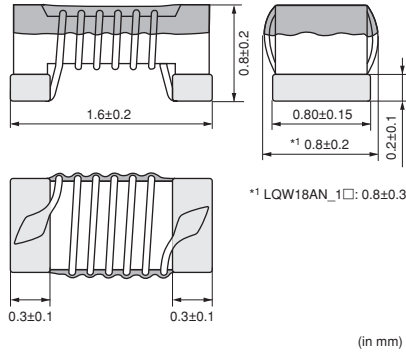

■ Packaging

Code	Packaging	Minimum Quantity
D	ø180mm Paper Taping	4000
J	ø330mm Paper Taping	10000
B	Packing in Bulk	500



Refer to pages from p.230 to p.232 for mounting information.

■ Rated Value (□: packaging code)

Part Number		Inductance	Inductance Test Frequency	Rated Current	Max. of DC Resistance	Q (min.)	Q Test Frequency	Self-Resonance Frequency (min.)
For Infotainment	For Powertrain/Safety							
LQW18AN2N2D0Z□	—	2.2nH ±0.5nH	100MHz	700mA	0.042Ω	16	250MHz	6000MHz
LQW18AN3N6C0Z□	—	3.6nH ±0.2nH	100MHz	850mA	0.059Ω	25	250MHz	6000MHz
LQW18AN3N6D0Z□	—	3.6nH ±0.5nH	100MHz	850mA	0.059Ω	25	250MHz	6000MHz
LQW18AN3N9C0Z□	—	3.9nH ±0.2nH	100MHz	850mA	0.059Ω	35	250MHz	6000MHz
LQW18AN3N9D0Z□	—	3.9nH ±0.5nH	100MHz	850mA	0.059Ω	35	250MHz	6000MHz
LQW18AN4N3C0Z□	—	4.3nH ±0.2nH	100MHz	850mA	0.059Ω	35	250MHz	6000MHz
LQW18AN4N3D0Z□	—	4.3nH ±0.5nH	100MHz	850mA	0.059Ω	35	250MHz	6000MHz
LQW18AN4N7D0Z□	—	4.7nH ±0.5nH	100MHz	850mA	0.059Ω	35	250MHz	6000MHz
LQW18AN5N6C0Z□	—	5.6nH ±0.2nH	100MHz	750mA	0.082Ω	35	250MHz	6000MHz
LQW18AN5N6D0Z□	—	5.6nH ±0.5nH	100MHz	750mA	0.082Ω	35	250MHz	6000MHz
LQW18AN6N2C0Z□	—	6.2nH ±0.2nH	100MHz	750mA	0.082Ω	35	250MHz	6000MHz
LQW18AN6N2D0Z□	—	6.2nH ±0.5nH	100MHz	750mA	0.082Ω	35	250MHz	6000MHz
LQW18AN6N8C0Z□	—	6.8nH ±0.2nH	100MHz	750mA	0.082Ω	35	250MHz	6000MHz
LQW18AN6N8D0Z□	—	6.8nH ±0.5nH	100MHz	750mA	0.082Ω	35	250MHz	6000MHz
LQW18AN7N5C0Z□	—	7.5nH ±0.2nH	100MHz	750mA	0.082Ω	35	250MHz	6000MHz
LQW18AN7N5D0Z□	—	7.5nH ±0.5nH	100MHz	750mA	0.082Ω	35	250MHz	6000MHz
LQW18AN8N2C0Z□	—	8.2nH ±0.2nH	100MHz	650mA	0.11Ω	35	250MHz	6000MHz
LQW18AN8N2D0Z□	—	8.2nH ±0.5nH	100MHz	650mA	0.11Ω	35	250MHz	6000MHz
LQW18AN8N7C0Z□	—	8.7nH ±0.2nH	100MHz	650mA	0.11Ω	35	250MHz	6000MHz
LQW18AN8N7D0Z□	—	8.7nH ±0.5nH	100MHz	650mA	0.11Ω	35	250MHz	6000MHz
LQW18AN9N1C0Z□	—	9.1nH ±0.2nH	100MHz	650mA	0.11Ω	35	250MHz	6000MHz
LQW18AN9N1D0Z□	—	9.1nH ±0.5nH	100MHz	650mA	0.11Ω	35	250MHz	6000MHz
LQW18AN9N5D0Z□	—	9.5nH ±0.5nH	100MHz	650mA	0.11Ω	35	250MHz	6000MHz
LQW18AN10NG0Z□	—	10nH ±2%	100MHz	650mA	0.11Ω	35	250MHz	6000MHz
LQW18AN10NJ0Z□	—	10nH ±5%	100MHz	650mA	0.11Ω	35	250MHz	6000MHz
LQW18AN11NG0Z□	—	11nH ±2%	100MHz	650mA	0.11Ω	35	250MHz	6000MHz
LQW18AN11NJ0Z□	—	11nH ±5%	100MHz	650mA	0.11Ω	35	250MHz	6000MHz
LQW18AN12NG0Z□	—	12nH ±2%	100MHz	600mA	0.13Ω	35	250MHz	6000MHz
LQW18AN12NJ0Z□	—	12nH ±5%	100MHz	600mA	0.13Ω	35	250MHz	6000MHz
LQW18AN13NG0Z□	—	13nH ±2%	100MHz	600mA	0.13Ω	35	250MHz	6000MHz
LQW18AN13NJ0Z□	—	13nH ±5%	100MHz	600mA	0.13Ω	35	250MHz	6000MHz
LQW18AN15NG0Z□	—	15nH ±2%	100MHz	600mA	0.13Ω	40	250MHz	6000MHz

Operating Temperature Range (Self-temperature rise is not included): -55°C~+125°C
For reflow soldering only.

Continued on the following page.

△Note • Please read rating and △CAUTION (for storage, operating, rating, soldering, mounting and handling) in this catalog to prevent smoking and/or burning, etc.
• This catalog has only typical specifications. Therefore, please approve our product specifications or transact the approval sheet for product specifications before ordering.

Part Number		Inductance	Inductance Test Frequency	Rated Current	Max. of DC Resistance	Q (min.)	Q Test Frequency	Self-Resonance Frequency (min.)
For Infotainment	For Powertrain/Safety							
LQW18AN15NJ0Z□	—	15nH ±5%	100MHz	600mA	0.13 Ω	40	250MHz	6000MHz
LQW18AN16NG0Z□	—	16nH ±2%	100MHz	550mA	0.16 Ω	40	250MHz	5500MHz
LQW18AN16NJ0Z□	—	16nH ±5%	100MHz	550mA	0.16 Ω	40	250MHz	5500MHz
LQW18AN18NG0Z□	—	18nH ±2%	100MHz	550mA	0.16 Ω	40	250MHz	5500MHz
LQW18AN18NJ0Z□	—	18nH ±5%	100MHz	550mA	0.16 Ω	40	250MHz	5500MHz
LQW18AN20NG0Z□	—	20nH ±2%	100MHz	550mA	0.16 Ω	40	250MHz	4900MHz
LQW18AN20NJ0Z□	—	20nH ±5%	100MHz	550mA	0.16 Ω	40	250MHz	4900MHz
LQW18AN22NG0Z□	—	22nH ±2%	100MHz	500mA	0.17 Ω	40	250MHz	4600MHz
LQW18AN22NJ0Z□	—	22nH ±5%	100MHz	500mA	0.17 Ω	40	250MHz	4600MHz
LQW18AN24NG0Z□	—	24nH ±2%	100MHz	500mA	0.21 Ω	40	250MHz	3800MHz
LQW18AN24NJ0Z□	—	24nH ±5%	100MHz	500mA	0.21 Ω	40	250MHz	3800MHz
LQW18AN27NG0Z□	—	27nH ±2%	100MHz	440mA	0.21 Ω	40	250MHz	3700MHz
LQW18AN27NJ0Z□	—	27nH ±5%	100MHz	440mA	0.21 Ω	40	250MHz	3700MHz
LQW18AN30NG0Z□	—	30nH ±2%	100MHz	420mA	0.23 Ω	40	250MHz	3300MHz
LQW18AN30NJ0Z□	—	30nH ±5%	100MHz	420mA	0.23 Ω	40	250MHz	3300MHz
LQW18AN33NG0Z□	—	33nH ±2%	100MHz	420mA	0.23 Ω	40	250MHz	3200MHz
LQW18AN33NJ0Z□	—	33nH ±5%	100MHz	420mA	0.23 Ω	40	250MHz	3200MHz
LQW18AN36NG0Z□	—	36nH ±2%	100MHz	400mA	0.26 Ω	40	250MHz	2900MHz
LQW18AN36NJ0Z□	—	36nH ±5%	100MHz	400mA	0.26 Ω	40	250MHz	2900MHz
LQW18AN39NG0Z□	—	39nH ±2%	100MHz	400mA	0.26 Ω	40	250MHz	2800MHz
LQW18AN39NJ0Z□	—	39nH ±5%	100MHz	400mA	0.26 Ω	40	250MHz	2800MHz
LQW18AN43NG0Z□	—	43nH ±2%	100MHz	380mA	0.29 Ω	40	200MHz	2700MHz
LQW18AN43NJ0Z□	—	43nH ±5%	100MHz	380mA	0.29 Ω	40	200MHz	2700MHz
LQW18AN47NG0Z□	—	47nH ±2%	100MHz	380mA	0.29 Ω	38	200MHz	2600MHz
LQW18AN47NJ0Z□	—	47nH ±5%	100MHz	380mA	0.29 Ω	38	200MHz	2600MHz
LQW18AN51NG0Z□	—	51nH ±2%	100MHz	370mA	0.33 Ω	38	200MHz	2500MHz
LQW18AN51NJ0Z□	—	51nH ±5%	100MHz	370mA	0.33 Ω	38	200MHz	2500MHz
LQW18AN56NG0Z□	—	56nH ±2%	100MHz	360mA	0.35 Ω	38	200MHz	2400MHz
LQW18AN56NJ0Z□	—	56nH ±5%	100MHz	360mA	0.35 Ω	38	200MHz	2400MHz
LQW18AN62NG0Z□	—	62nH ±2%	100MHz	280mA	0.51 Ω	38	200MHz	2300MHz
LQW18AN62NJ0Z□	—	62nH ±5%	100MHz	280mA	0.51 Ω	38	200MHz	2300MHz
LQW18AN68NG0Z□	—	68nH ±2%	100MHz	340mA	0.38 Ω	38	200MHz	2200MHz
LQW18AN68NJ0Z□	—	68nH ±5%	100MHz	340mA	0.38 Ω	38	200MHz	2200MHz
LQW18AN72NG0Z□	—	72nH ±2%	100MHz	270mA	0.56 Ω	34	150MHz	2100MHz
LQW18AN72NJ0Z□	—	72nH ±5%	100MHz	270mA	0.56 Ω	34	150MHz	2100MHz
LQW18AN75NG0Z□	—	75nH ±2%	100MHz	270mA	0.56 Ω	34	150MHz	2050MHz
LQW18AN75NJ0Z□	—	75nH ±5%	100MHz	270mA	0.56 Ω	34	150MHz	2050MHz
LQW18AN82NG0Z□	—	82nH ±2%	100MHz	250mA	0.60 Ω	34	150MHz	2000MHz
LQW18AN82NJ0Z□	—	82nH ±5%	100MHz	250mA	0.60 Ω	34	150MHz	2000MHz
LQW18AN91NG0Z□	—	91nH ±2%	100MHz	230mA	0.64 Ω	34	150MHz	1900MHz
LQW18AN91NJ0Z□	—	91nH ±5%	100MHz	230mA	0.64 Ω	34	150MHz	1900MHz
LQW18ANR10G0Z□	—	100nH ±2%	100MHz	220mA	0.68 Ω	34	150MHz	1800MHz
LQW18ANR10J0Z□	—	100nH ±5%	100MHz	220mA	0.68 Ω	34	150MHz	1800MHz
LQW18ANR11G0Z□	—	110nH ±2%	100MHz	200mA	1.2 Ω	32	150MHz	1700MHz
LQW18ANR11J0Z□	—	110nH ±5%	100MHz	200mA	1.2 Ω	32	150MHz	1700MHz
LQW18ANR12G0Z□	—	120nH ±2%	100MHz	180mA	1.3 Ω	32	150MHz	1600MHz
LQW18ANR12J0Z□	—	120nH ±5%	100MHz	180mA	1.3 Ω	32	150MHz	1600MHz

Operating Temperature Range (Self-temperature rise is not included): -55°C~+125°C
For reflow soldering only.

Continued on the following page. 

△Note • Please read rating and △CAUTION (for storage, operating, rating, soldering, mounting and handling) in this catalog to prevent smoking and/or burning, etc.
• This catalog has only typical specifications. Therefore, please approve our product specifications or transact the approval sheet for product specifications before ordering.

Part Number		Inductance	Inductance Test Frequency	Rated Current	Max. of DC Resistance	Q (min.)	Q Test Frequency	Self-Resonance Frequency (min.)
For Infotainment	For Powertrain/Safety							
LQW18ANR13G0Z□	—	130nH ±2%	100MHz	170mA	1.4Ω	32	150MHz	1450MHz
LQW18ANR13J0Z□	—	130nH ±5%	100MHz	170mA	1.4Ω	32	150MHz	1450MHz
LQW18ANR15G0Z□	—	150nH ±2%	100MHz	160mA	1.5Ω	32	150MHz	1400MHz
LQW18ANR15J0Z□	—	150nH ±5%	100MHz	160mA	1.5Ω	32	150MHz	1400MHz
LQW18ANR16G0Z□	—	160nH ±2%	100MHz	150mA	2.1Ω	32	150MHz	1350MHz
LQW18ANR16J0Z□	—	160nH ±5%	100MHz	150mA	2.1Ω	32	150MHz	1350MHz
LQW18ANR18G0Z□	—	180nH ±2%	100MHz	140mA	2.2Ω	25	100MHz	1300MHz
LQW18ANR18J0Z□	—	180nH ±5%	100MHz	140mA	2.2Ω	25	100MHz	1300MHz
LQW18ANR20G0Z□	—	200nH ±2%	100MHz	120mA	2.4Ω	25	100MHz	1250MHz
LQW18ANR20J0Z□	—	200nH ±5%	100MHz	120mA	2.4Ω	25	100MHz	1250MHz
LQW18ANR22G0Z□	—	220nH ±2%	100MHz	120mA	2.5Ω	25	100MHz	1200MHz
LQW18ANR22J0Z□	—	220nH ±5%	100MHz	120mA	2.5Ω	25	100MHz	1200MHz
LQW18ANR27G0Z□	—	270nH ±2%	100MHz	110mA	3.4Ω	30	100MHz	960MHz
LQW18ANR27J0Z□	—	270nH ±5%	100MHz	110mA	3.4Ω	30	100MHz	960MHz
LQW18ANR33G0Z□	—	330nH ±2%	100MHz	85mA	5.5Ω	30	100MHz	800MHz
LQW18ANR33J0Z□	—	330nH ±5%	100MHz	85mA	5.5Ω	30	100MHz	800MHz
LQW18ANR39G0Z□	—	390nH ±2%	100MHz	80mA	6.2Ω	30	100MHz	800MHz
LQW18ANR39J0Z□	—	390nH ±5%	100MHz	80mA	6.2Ω	30	100MHz	800MHz
LQW18ANR47G0Z□	—	470nH ±2%	100MHz	75mA	7.0Ω	30	100MHz	700MHz
LQW18ANR47J0Z□	—	470nH ±5%	100MHz	75mA	7.0Ω	30	100MHz	700MHz

Operating Temperature Range (Self-temperature rise is not included): -55°C~+125°C
For reflow soldering only.

■ Q-Frequency Characteristics (Typ.)

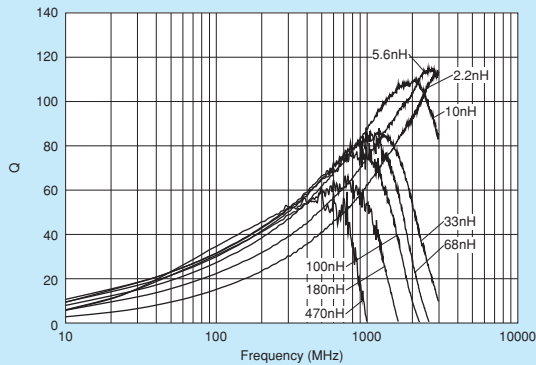

■ Inductance-Frequency Characteristics (Typ.)

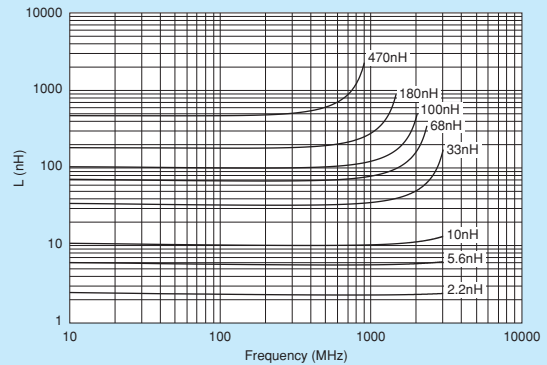

△Note • Please read rating and △CAUTION (for storage, operating, rating, soldering, mounting and handling) in this catalog to prevent smoking and/or burning, etc.
• This catalog has only typical specifications. Therefore, please approve our product specifications or transact the approval sheet for product specifications before ordering.

Wire Wound Type (Non-Magnetic Core)

LQW18AN_1Z

Series 0603/1608 (inch/mm)

Size Code 0603 (1608) in inch (in mm), High Q, Low DC Resistance Type

■ Appearance/Dimensions

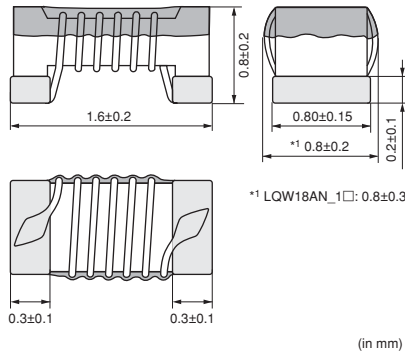

■ Packaging

Code	Packaging	Minimum Quantity
D	ø180mm Paper Taping	4000
J	ø330mm Paper Taping	10000
B	Packing in Bulk	500



Refer to pages from p.230 to p.232 for mounting information.

■ Rated Value (□: packaging code)

Part Number		Inductance	Inductance Test Frequency	Rated Current	Max. of DC Resistance	Q (min.)	Q Test Frequency	Self-Resonance Frequency (min.)
For Infotainment	For Powertrain/Safety							
LQW18AN2N2D1Z□	—	2.2nH ±0.5nH	100MHz	1400mA	0.018Ω	25	250MHz	18000MHz
LQW18AN3N9C1Z□	—	3.9nH ±0.2nH	100MHz	1000mA	0.032Ω	38	250MHz	11000MHz
LQW18AN3N9D1Z□	—	3.9nH ±0.5nH	100MHz	1000mA	0.032Ω	38	250MHz	11000MHz
LQW18AN5N6D1Z□	—	5.6nH ±0.5nH	100MHz	900mA	0.045Ω	38	250MHz	10000MHz
LQW18AN6N8C1Z□	—	6.8nH ±0.2nH	100MHz	900mA	0.045Ω	38	250MHz	7000MHz
LQW18AN6N8D1Z□	—	6.8nH ±0.5nH	100MHz	900mA	0.045Ω	38	250MHz	7000MHz
LQW18AN8N2D1Z□	—	8.2nH ±0.5nH	100MHz	800mA	0.058Ω	38	250MHz	7000MHz
LQW18AN10NG1Z□	—	10nH ±2%	100MHz	800mA	0.058Ω	38	250MHz	5000MHz
LQW18AN10NJ1Z□	—	10nH ±5%	100MHz	800mA	0.058Ω	38	250MHz	5000MHz
LQW18AN12NG1Z□	—	12nH ±2%	100MHz	750mA	0.071Ω	38	250MHz	5000MHz
LQW18AN12NJ1Z□	—	12nH ±5%	100MHz	750mA	0.071Ω	38	250MHz	5000MHz
LQW18AN15NJ1Z□	—	15nH ±5%	100MHz	700mA	0.085Ω	42	250MHz	4500MHz
LQW18AN18NG1Z□	—	18nH ±2%	100MHz	700mA	0.085Ω	42	250MHz	3500MHz
LQW18AN18NJ1Z□	—	18nH ±5%	100MHz	700mA	0.085Ω	42	250MHz	3500MHz
LQW18AN22NG1Z□	—	22nH ±2%	100MHz	640mA	0.099Ω	42	250MHz	3200MHz
LQW18AN22NJ1Z□	—	22nH ±5%	100MHz	640mA	0.099Ω	42	250MHz	3200MHz
LQW18AN27NG1Z□	—	27nH ±2%	100MHz	590mA	0.116Ω	42	250MHz	2800MHz
LQW18AN27NJ1Z□	—	27nH ±5%	100MHz	590mA	0.116Ω	42	250MHz	2800MHz
LQW18AN33NJ1Z□	—	33nH ±5%	100MHz	550mA	0.132Ω	42	250MHz	2500MHz

Operating Temperature Range (Self-temperature rise is not included): -55°C~+125°C For reflow soldering only.

■ Q-Frequency Characteristics (Typ.)

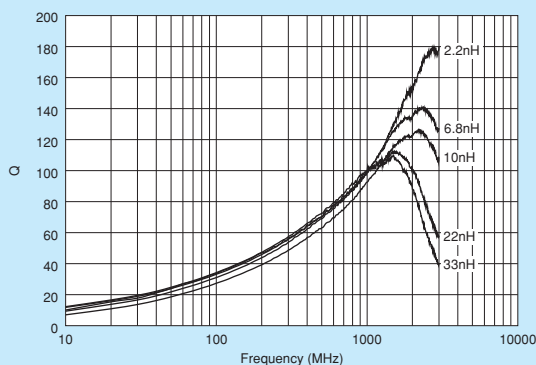

■ Inductance-Frequency Characteristics (Typ.)

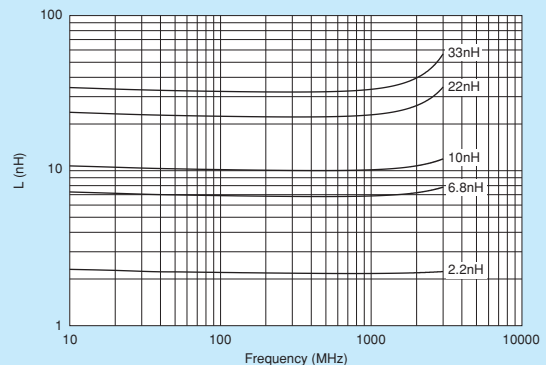

△Note • Please read rating and △CAUTION (for storage, operating, rating, soldering, mounting and handling) in this catalog to prevent smoking and/or burning, etc.
• This catalog has only typical specifications. Therefore, please approve our product specifications or transact the approval sheet for product specifications before ordering.

⚠ Caution

● Rating

1. About the Rated Current

Do not use products beyond the rated current as this may create excessive heat and deteriorate the insulation resistance.

2. About Excessive Surge Current

Surge current (pulse current or rush current) greater than the specified rated current applied to the product may cause a critical failure, such as an open circuit, burnout caused by excessive temperature rise. Please contact us in advance in case of applying the surge current.

Notice

● Storage and Operating Condition

<Operating Environment>

Do not use products in chemical atmosphere such as chlorine gas, acid or sulfide gas.

<Storage Requirements>

1. Storage Period

LQG series should be used within 6 months; the other products should be used within 12 months. Check solderability if this period is exceeded.

2. Storage Conditions

(1) Store products in a warehouse in compliance with the following conditions:

Temperature: -10 to +40 degrees C.

Humidity: 15 to 85% (relative humidity)

Do not subject products to rapid changes in temperature and humidity.

Do not store them in chemical atmosphere such as one containing sulfurous acid gas or alkaline gas.

This will prevent electrode oxidation, which causes poor solderability and possible corrosion of inductors.

(2) Do not store products in bulk packaging to prevent collision among inductors, which causes core chipping and wire breakage.

(3) Store products on pallets to protect from humidity, dust, etc.

(4) Avoid heat shock, vibration, direct sunlight, etc.

● Handling

This item is designed to have sufficient strength, but handle with care to avoid chipping or breaking its ceramic structure.

LQW_A series

- To prevent breaking the wire, avoid touching with sharp material, such as tweezers or the bristles of a cleaning brush, to the wire wound portion.
- To prevent breaking the core, avoid applying excessive mechanical shock to products mounted on the board.

- In some mounting machines, when picking up components, a support pin pushes the components up from the bottom of the base tape. In this case, please remove the support pin. The support pin may damage the components and break the wire.
- In rare cases, the laser recognition cannot recognize this component. Please contact us when you use laser recognition. (There is no problem with the permeation and reflection type.)

LQP series

- The pattern of the chip Inductors is covered with protective film. Take care to avoid damaging the chip Inductors when handling it with pick-up nozzles, sharp instruments, etc.

<Handling>

1. Avoid applying excessive stress to products to prevent damage.
2. Do not touch wire wound with sharp objects such as tweezers to prevent wire breakage.
3. Do not apply excessive force to products mounted on boards to prevent core breakage.

<Transportation>

Do not apply excessive vibration or mechanical shock to products.

<Resin Coating>

When coating products with resin, the relatively high resin curing stress may change inductance values. For exterior coating, select resin carefully so that electrical and mechanical performance of the product is not affected. Prior to use, please evaluate reliability with the product mounted in your application set.

(LQW series)

An open circuit issue may occur by mechanical stress caused by the resin, amount/cured shape of resin, or operating conditions, etc. Some resins containing impurities or chloride may possibly generate chlorine by hydrolysis under some operating conditions, causing corrosion of the inductor wire and leading to an open circuit.

(LQP03 series)

When products are coated with resin, please contact us in advance.

Continued on the following page. 

⚠ Note • Please read rating and ⚠ CAUTION (for storage, operating, rating, soldering, mounting and handling) in this catalog to prevent smoking and/or burning, etc.
• This catalog has only typical specifications. Therefore, please approve our product specifications or transact the approval sheet for product specifications before ordering.

<Handling of a Substrate>

After mounting products on a substrate, do not apply any stress to the product caused by bending or twisting the substrate when cropping the substrate, inserting and removing a connector from the substrate, or tightening a screw to the substrate.

Excessive mechanical stress may cause cracking in the Product.

Bending

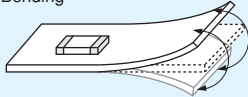

Twisting

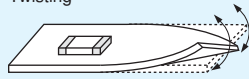

● Measuring Method

Measuring Method of Inductance/Q

1. Residual elements and stray elements of test fixtures can be described by F-parameter as shown in the following:

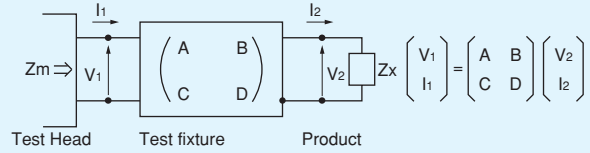

2. The impedance of chip Inductors (chip coils) Z_x and measured value Z_m can be described by input/output current/voltage.

$$Z_m = \frac{V_1}{I_1}, \quad Z_x = \frac{V_2}{I_2}$$

3. Thus, the relation between Z_x and Z_m is shown in the following:

$$Z_x = \alpha \frac{Z_m - \beta}{1 - Z_m \Gamma} \quad \text{where, } \alpha = D / A = 1$$

$$\beta = B / D = Z_{sm} - (1 - Y_{om} Z_{sm}) Z_{ss}$$

$$\Gamma = C / A = Y_{om}$$

Z_{sm} : measured impedance of short chip
 Z_{ss} : residual impedance of short chip*
 Y_{om} : measured admittance when opening the fixture

*Residual impedance of short chip

Residual Impedance	Series
0nH	LQG15H
0.480nH	LQP03TN
0.556nH	LQW15A
0.771nH	LQG18H, LQW18A

4. L_x and Q_x should be calculated with the following equation.

$$L_x = \frac{\text{Im}(Z_x)}{2\pi f}, \quad Q_x = \frac{\text{Im}(Z_x)}{\text{Re}(Z_x)}$$

L_x : Inductance of chip Inductors (chip coils)

Q_x : Q of chip Inductors (chip coils)

f: Measuring frequency

⚠Note • Please read rating and ⚠CAUTION (for storage, operating, rating, soldering, mounting and handling) in this catalog to prevent smoking and/or burning, etc.
 • This catalog has only typical specifications. Therefore, please approve our product specifications or transact the approval sheet for product specifications before ordering.

1. Standard Land Pattern Dimensions

A high Q value is achieved when the PCB electrode land pattern is designed so that it does not project beyond the chip Inductors (chip coils) electrode.

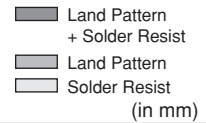

Series	Standard Land Dimensions																											
LQG15H LQG18H LQP03 LQW15A LQW18A				<table border="1"> <thead> <tr> <th>Part Number</th> <th>a</th> <th>b</th> <th>c</th> </tr> </thead> <tbody> <tr> <td>LQG15H</td> <td>0.4</td> <td>1.4-1.5</td> <td>0.5-0.6</td> </tr> <tr> <td>LQG18H</td> <td>0.6-0.8</td> <td>1.8-2.2</td> <td>0.6-0.8</td> </tr> <tr> <td>LQP03</td> <td>0.2-0.3</td> <td>0.8-0.9</td> <td>0.2-0.3</td> </tr> <tr> <td>LQW15A</td> <td>0.5</td> <td>1.2</td> <td>0.65</td> </tr> <tr> <td>LQW18A</td> <td>0.6-0.8</td> <td>1.9-2.0</td> <td>0.7-1.0</td> </tr> </tbody> </table>	Part Number	a	b	c	LQG15H	0.4	1.4-1.5	0.5-0.6	LQG18H	0.6-0.8	1.8-2.2	0.6-0.8	LQP03	0.2-0.3	0.8-0.9	0.2-0.3	LQW15A	0.5	1.2	0.65	LQW18A	0.6-0.8	1.9-2.0	0.7-1.0
	Part Number	a	b	c																								
	LQG15H	0.4	1.4-1.5	0.5-0.6																								
	LQG18H	0.6-0.8	1.8-2.2	0.6-0.8																								
	LQP03	0.2-0.3	0.8-0.9	0.2-0.3																								
	LQW15A	0.5	1.2	0.65																								
LQW18A	0.6-0.8	1.9-2.0	0.7-1.0																									

Attention should be paid to potential magnetic coupling effects when using the Inductors (coils) as a resonator.

2. Standard Soldering Conditions

(1) Soldering method

Chip Inductors (Chip coils) can be flow or reflow soldered. Please contact Murata regarding other soldering methods. As for LQG, LQP, LQW series, please use reflow soldering.

Solder: Use Sn-3.0Ag-0.5Cu solder.

Flux: Use rosin-based flux, but not strongly acidic flux (with chlorine content exceeding 0.2wt%). Do not use water-soluble flux.

The flux used for LQW series should use the rosin-based flux that includes middle activator equivalent to 0.06wt% to 0.1wt% chlorine.

For additional mounting methods, please contact Murata.

(2) Soldering profile

● Reflow Soldering profile (Sn-3.0Ag-0.5Cu solder)

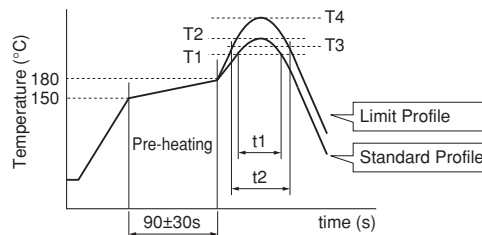

Series	Standard Profile				Limit Profile			
	Heating		Peak temperature (T2)	Cycle of reflow	Heating		Peak temperature (T4)	Cycle of reflow
	Temp. (T1)	Time. (t1)			Temp. (T3)	Time. (t2)		
LQG15H/18H LQP03 LQW15A/18A	220°C	30 to 60s	245±3°C	2 times max.	230°C	60s max.	260°C/10s	2 times max.

(3) Reworking with Soldering Iron

Preheating at 150°C for 1 minute is required. Do not directly touch the ceramic element with the tip of the soldering iron. The reworking soldering conditions are as follows:

Soldering iron power output: 80W max.
 Temperature of soldering iron tip: 350°C
 Diameter of soldering iron end: 3.0mm max.
 Soldering time: within 3 s

Continued on the following page.

△Note • Please read rating and △CAUTION (for storage, operating, rating, soldering, mounting and handling) in this catalog to prevent smoking and/or burning, etc.
 • This catalog has only typical specifications. Therefore, please approve our product specifications or transact the approval sheet for product specifications before ordering.

3. Mounting Instructions

(1) Land Pattern Dimensions

Large lands reduce Q of the mounted chip. Also, large protruding land areas (bordered by lines having dimensions 'c' and 'd' shown) cause floating and electrode leaching.

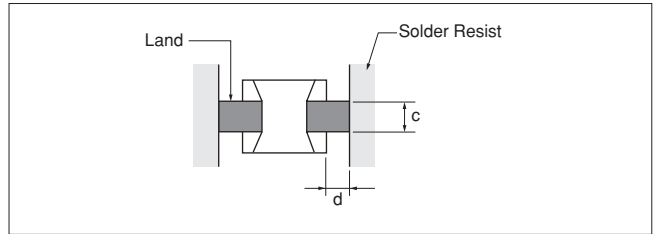

(2) Land Pattern Designing (LQW series)

Please follow the recommended patterns. Otherwise, their performance, which includes electrical performance or solderability, may be affected, or result in "position shift" in the soldering process.

(3) PCB Warping

PCB should be designed so that products are not subjected to the mechanical stress caused by warping the board.

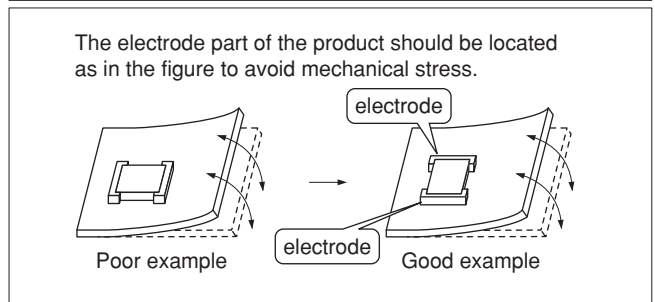
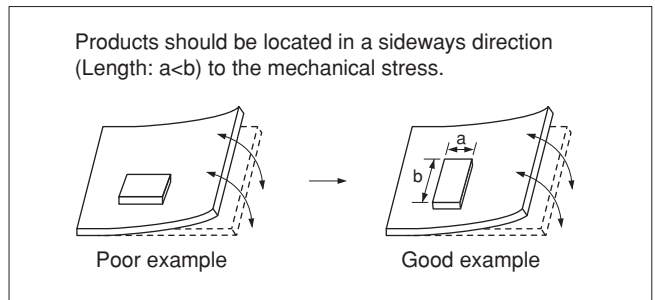

(4) Amount of Solder Paste

Excessive solder causes electrode corrosion, while insufficient solder causes low electrode bonding strength. Adjust the amount of solder paste as shown on the right so that solder is applied.

- Guideline of solder paste thickness
 - LQG, LQW15A/LQW18A: 100 to 150µm
 - LQP03TN: 100µm

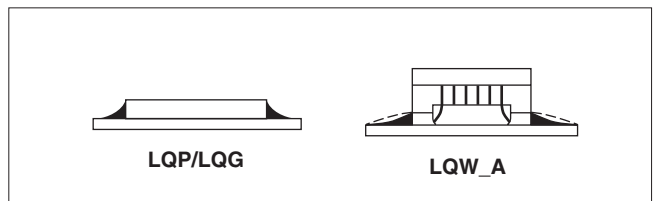

LQW15A Series:

Too much solder may cause slant or rotation of the chip at the time of solder melting. Please reduce the amount of solder by using a smaller solder area than the land pattern, as shown in the figure at right.

a	0.65
b	0.35
c	0.50
d	0.30

Stencil Pattern Land Pattern

Stencil Pattern Land Pattern

(in mm)

Continued on the following page. ↗

⚠Note • Please read rating and ⚠CAUTION (for storage, operating, rating, soldering, mounting and handling) in this catalog to prevent smoking and/or burning, etc.
 • This catalog has only typical specifications. Therefore, please approve our product specifications or transact the approval sheet for product specifications before ordering.

4. Cleaning

The following conditions should be observed when cleaning chip inductors (chip coils):

(1) Cleaning Temperature: 60°C max. (40°C max. for alcohol cleaning agents)

(2) Ultrasonic

Output: 20W/l max.

Duration: 5 minutes max.

Frequency: 28 to 40kHz

Care should be taken not to cause resonance of the PCB and mounted products.

(3) Cleaning agent

The following cleaning agents have been tested on individual components. Evaluation in complete assembly should be done prior to production.

(a) Alcohol cleaning agents

Isopropyl alcohol (IPA)

(b) Aqueous cleaning agents

Pine Alpha ST-100S

(4) Ensure that flux residue is completely removed.

Component should be thoroughly dried after aqueous agents have been removed with deionized water.

For additional cleaning methods, please contact Murata.

■ Minimum Quantity and 8mm Width Taping Dimensions

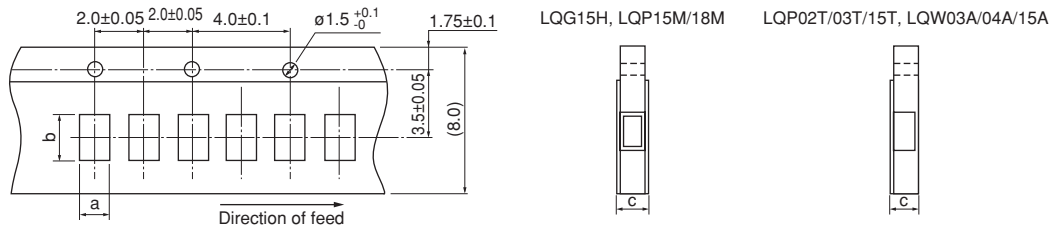

Paper Tape

Part Number	Dimensions		Total Thickness of Tape	Packaging Code (Minimum Qty. [pcs.])		
	a	b		c	ø180mm reel	ø330mm reel
LQG15H	0.62	1.12	0.8 max.	D [10000]	J [50000]	B [1000]
LQP03T *1	0.35	0.65/0.67	0.55 max.	D [15000]	J [50000]	B [500]
LQW15A_0Z *2	0.64/0.66/0.69	1.18	0.8 max.	D [10000]	-	B [500]
LQW15A_1Z *3	0.66/0.69	1.18	0.8 max.	D [10000]	-	B [500]

- *1 0.67 (LQP03TN_Z2; 0.6-62nH)
0.65 (LQP03TN_Z2; 68-120nH)
- *2 0.69 (1.5nH, 2.4-2.8nH, 3.9-4.8nH, 5.8-6.8nH, 8.2-9.9nH, 11nH, 12nH, 15nH)
0.66 (1.6-1.8nH, 2.9nH, 3.0nH, 3.1nH, 3.2nH, 4.9-5.1nH, 6.9-7.5nH, 10nH, 13nH, 16-23nH, 100nH, 120nH)
0.64 (24-91nH)
- *3 0.69 (1.3nH, 1.4nH)
0.66 (2.2-8.4nH)

(in mm)

■ Minimum Quantity and 8mm Width Taping Dimensions

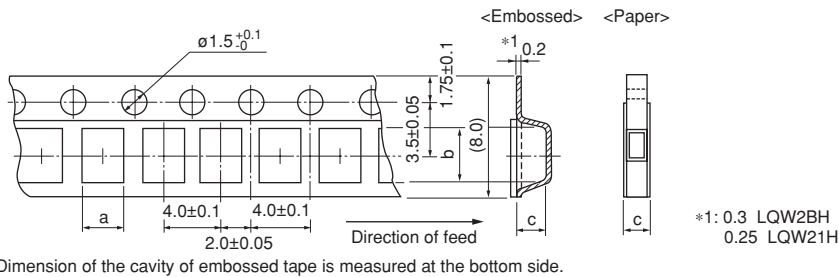

Dimension of the cavity of embossed tape is measured at the bottom side.

Paper Tape

Part Number	Dimensions		Total Thickness of Tape	Packaging Code (Minimum Qty. [pcs.])		
	a	b		c	ø180mm reel	ø330mm reel
LQG18H	1.05	1.85	1.1 max.	D [4000]	J [10000]	B [1000]
LQW18A_0Z	1.0	1.8	1.1 max.	D [4000]	J [10000]	B [500]
LQW18A_1Z	1.1	1.9	1.1 max.	D [4000]	J [10000]	B [500]

(in mm)

⚠Note • Please read rating and ⚠CAUTION (for storage, operating, rating, soldering, mounting and handling) in this catalog to prevent smoking and/or burning, etc.
• This catalog has only typical specifications. Therefore, please approve our product specifications or transact the approval sheet for product specifications before ordering.



EMI Suppression Filters (for DC)

Chip Ferrite Bead

BLE32PN	p.61
BLM03AG	p.17
BLM03AX	p.15
BLM03B	p.19
BLM03E	p.64
BLM03H	p.62
BLM03PG	p.12
BLM03PX	p.13
BLM15AG	p.27
BLM15AX	p.25
BLM15B	p.31
BLM15BX	p.29
BLM15EG	p.67
BLM15G	p.68
BLM15H	p.65
BLM15PD	p.23
BLM15PG	p.23
BLM15PX	p.21
BLM18AG_S	p.41
BLM18AG_W	p.43
BLM18B	p.44
BLM18EG	p.72
BLM18GG	p.75
BLM18H	p.69
BLM18KG	p.37
BLM18PG	p.35
BLM18SG	p.39
BLM21AG	p.51
BLM21B	p.53
BLM21PG	p.49
BLM31PG	p.57
BLM41PG	p.59

Chip EMIFIL®

NFE31ZT	p.85
NFE61HT	p.86
NFL18ZT	p.89
NFM21HC	p.87
NFM31HK	p.88
NFZ32BW_10	p.90
NFZ32BW_11	p.92

Block Type EMIFIL®

BNX02□	p.125
--------	-------

Lead Type

BNX012	p.136
DSS1	p.133
VFC2	p.135

Chip Common Mode Choke Coil

DLM11S	p.107
DLW21S	p.108
DLW31S	p.110
DLW43S	p.111
DLW5AT	p.105
DLW5BS	p.104
DLW5BT	p.105
PLT10H	p.112
PLT5BP	p.113

Microchip Transformer (Balun)

DXW21B	p.145
--------	-------

Chip Inductors

Inductors for Power Lines

LQH2HPZ_JR	p.183
LQH32CH_23	p.187
LQH32CH_33	p.187
LQH32CH_53	p.188
LQH32DZ_23	p.185
LQH32DZ_53	p.186
LQH32PZ_NO	p.173
LQH32PZ_NC	p.175
LQH3NPZ_JR	p.171
LQH43PZ_26	p.177
LQH44PZ_GR	p.179
LQH5BPZ_T0	p.181
LQM21P_GC	p.160
LQM21PZ_C0	p.158
LQM21PZ_G0	p.159
LQM21PZ_GR	p.161
LQM2HPZ_E0	p.170
LQM2HPZ_G0	p.166
LQM2HPZ_GC	p.169
LQM2HPZ_GS	p.168
LQM2HPZ_J0	p.164
LQM2HPZ_JC	p.165
LQM2MPZ_G0	p.162

Inductors for General Circuits

LQH31HZ_03	p.198
LQH43NZ_03	p.199

RF Inductors

LQG15H_02	p.208
LQG18HH_00	p.210
LQP03TN_Z2	p.212
LQW15AN_OZ	p.216
LQW15AN_1Z	p.222
LQW18AN_OZ	p.224
LQW18AN_1Z	p.227

⚠Note • Please read rating and ⚠CAUTION (for storage, operating, rating, soldering, mounting and handling) in this catalog to prevent smoking and/or burning, etc.
• This catalog has only typical specifications. Therefore, please approve our product specifications or transact the approval sheet for product specifications before ordering.

Introduction of Chip Inductors Web Site Design Support Software SimSurfing

SimSurfing is the latest tool to get the electrical characteristics for Power Inductors or RF Inductors on the Internet !

You can easily search and download the following data for Inductors with no special software.

New Features 《Power Inductor Selection Tool》

Some function of Microsoft Excel® application version "Power Inductor Selection Tool" has been integrated to SimSurfing. (※)

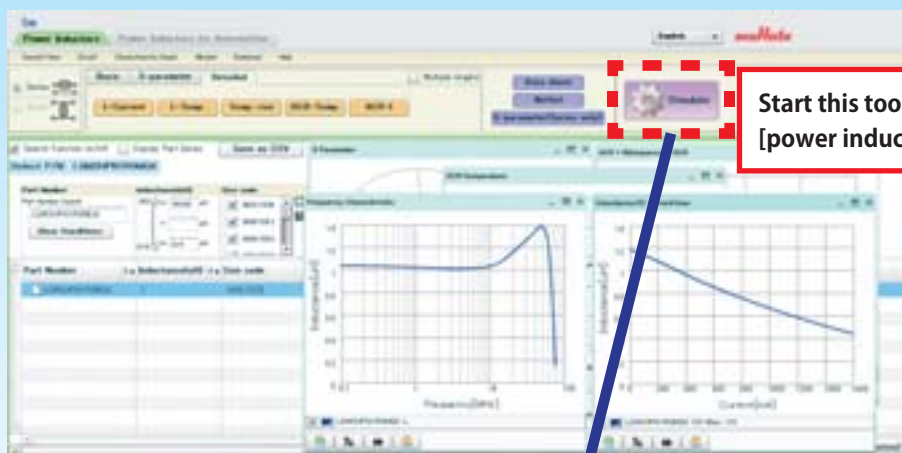

Start this tool on the category page in [power inductors].

Operating condition setting of DC-DC converter

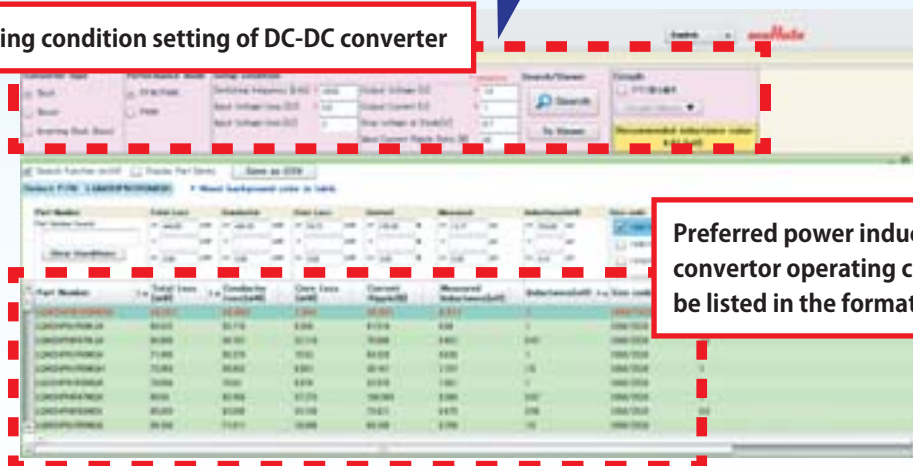

Preferred power inductor to DC-DC converter operating condition will be listed in the format of ranking.

※The function of this tool is limited from Excel® application version.
Excel® application version can be downloaded at following URL.
http://www.murata.com/products/design_support/dl_soft/index.html

<http://ds.murata.co.jp/software/simsurfing/en-us/>

△Note • Please read rating and △CAUTION (for storage, operating, rating, soldering, mounting and handling) in this catalog to prevent smoking and/or burning, etc.
• This catalog has only typical specifications. Therefore, please approve our product specifications or transact the approval sheet for product specifications before ordering.

Global Locations

For details please visit www.murata.com



⚠ Note

1 Export Control

For customers outside Japan:

No Murata products should be used or sold, through any channels, for use in the design, development, production, utilization, maintenance or operation of, or otherwise contribution to (1) any weapons (Weapons of Mass Destruction [nuclear, chemical or biological weapons or missiles] or conventional weapons) or (2) goods or systems specially designed or intended for military end-use or utilization by military end-users.

For customers in Japan:

For products which are controlled items subject to the "Foreign Exchange and Foreign Trade Law" of Japan, the export license specified by the law is required for export.

2 Please contact our sales representatives or product engineers before using the products in this catalog for the applications listed below, which require especially high reliability for the prevention of defects which might directly damage a third party's life, body or property, or when one of our products is intended for use in applications other than those specified in this catalog.

- ① Aircraft equipment
- ② Aerospace equipment
- ③ Undersea equipment
- ④ Power plant equipment
- ⑤ Medical equipment
- ⑥ Transportation equipment (vehicles, trains, ships, etc.)
- ⑦ Traffic signal equipment
- ⑧ Disaster prevention / crime prevention equipment
- ⑨ Data-processing equipment
- ⑩ Application of similar complexity and/or reliability requirements to the applications listed above

3 Product specifications in this catalog are as of July 2014. They are subject to change or our products in it may be discontinued without advance notice. Please check with our sales representatives or product engineers before ordering. If there are any questions, please contact our sales representatives or product engineers.

4 Please read rating and ⚠CAUTION (for storage, operating, rating, soldering, mounting and handling) in this catalog to prevent smoking and/or burning, etc.

5 This catalog has only typical specifications. Therefore, please approve our product specifications or transact the approval sheet for product specifications before ordering.

6 Please note that unless otherwise specified, we shall assume no responsibility whatsoever for any conflict or dispute that may occur in connection with the effect of our and/or a third party's intellectual property rights and other related rights in consideration of your use of our products and/or information described or contained in our catalogs. In this connection, no representation shall be made to the effect that any third parties are authorized to use the rights mentioned above under licenses without our consent.

7 No ozone depleting substances (ODS) under the Montreal Protocol are used in our manufacturing process.

Murata Manufacturing Co., Ltd.

www.murata.com

muRata
INNOVATOR IN ELECTRONICS

Mouser Electronics

Authorized Distributor

Click to View Pricing, Inventory, Delivery & Lifecycle Information:

Murata:

[BLM21AH601SH1D](#) [LQH32CH100K23L](#) [LQH32CH100K33L](#) [LQH32CH100K53L](#) [LQH32CH150K53L](#)
[LQH32CH1R0M23L](#) [LQH32CH1R0M33L](#) [LQH32CH1R0M53L](#) [LQH32CH220K23L](#) [LQH32CH220K53L](#)
[LQH32CH2R2M23L](#) [LQH32CH2R2M33L](#) [LQH32CH2R2M53L](#) [LQH32CH3R3M53L](#) [LQH32CH4R7M23L](#)
[LQH32CH4R7M33L](#) [LQH32CH4R7M53L](#) [LQH32CH6R8M53L](#) [LQH32CHR15M33L](#) [LQH32CHR27M33L](#)
[LQH32CHR47M33L](#) [VFC2HR71D105K2M1A](#) [BLM15HG102SH1D](#) [BLM15HG601SH1D](#) [BLM15HD182SH1D](#)
[BLM15HD102SH1D](#) [BLM15HD601SH1D](#) [BLM18KG700TZ1D](#) [LQW15AN6N2C0ZD](#) [LQP03HQ11NH02D](#)
[LQW15AN1N4D10D](#) [LQP03TN1N6CZ2D](#) [LQW15AN5N5D1ZD](#) [LQW15AN6N5C0ZD](#) [LQW15AN3N2C0ZD](#)
[LQW15AN5N7D10D](#) [LQW18AN22NJ1ZD](#) [LQW15CN34NJ10D](#) [LQW15AN3N6C1ZD](#) [LQW18AN72NJ0ZD](#)
[BLM03AX100SZ1D](#) [BLM21BB600SZ1D](#) [LQW15AN51NG80D](#) [LQW04AN2N8D00D](#) [LQW18AS30NG00D](#)
[LQW18ANR16J0ZD](#) [LQW15AN2N5C0ZD](#) [LQW15AN3N9G80D](#) [LQW15CNR18J10D](#) [LQW18AS24NG00D](#)
[LQP03TN68NJZ2D](#) [LQW15AN10NJ0ZD](#) [LQP03TN82NHZ2D](#) [LQW18ANR15J0ZD](#) [BLM18BD601SZ1D](#)
[LQW04AN4N6C00D](#) [LQW15AN5N0D0ZD](#) [LQP03HQ5N6J02D](#) [LQP02TQ2N6C02D](#) [LQW18AS8N2G00D](#)
[LQW15AN51NH0ZD](#) [BLM18HB221SZ1D](#) [LQW15AN7N5J0ZD](#) [BLM15BX750SZ1D](#) [BLM18BA121SZ1D](#)
[LQW15AN3N8D1ZD](#) [LQW15AN62NJ0ZD](#) [BLM15PG100SZ1D](#) [LQW18ANR18G0ZD](#) [LQW15AN6N6C00D](#)
[LQW15AN68NJ0ZD](#) [BLM03HG122SZ1D](#) [BLM15HG102SZ1D](#) [LQW15AN2N7B0ZD](#) [LQW04AN8N8C00D](#)
[LQW15AN9N3G00D](#) [LQP03TN20NHZ2D](#) [BLM41PG471SZ1L](#) [LQP03HQ9N1J02D](#) [LQH5BPN151M38L](#)
[LQW15AN3N4D1ZD](#) [LQG15HZ33NJ02D](#) [DSS1ZB32A220Q91A](#) [LQH5BPZ2R7NT0L](#) [DSS1ZB32A151Q91A](#)
[BLM18BB221SZ1D](#) [LQW18AN7N5G80D](#) [LQH32PZ680MN0L](#) [LQW15AN13NH0ZD](#) [LQW18AN3N9D1ZD](#)
[LQW15AN43NH0ZD](#) [LQH32DZ100K53L](#) [LQP02TQ2N1B02D](#) [LQP03HQ13NJ02D](#) [LQW15AN4N4C00D](#)
[LQW15AN4N2G80D](#) [LQW18AN16NJ0ZD](#) [BLM21PG331SZ1D](#) [LQW15AN5N3C1ZD](#) [LQW15AN39NJ0ZD](#)