

# ADT7484A/ADT7486A

## Digital Temperature Sensor with SST Interface

The ADT7484A/ADT7486A are simple digital temperature sensors for use in PC applications with a Simple Serial Transport (SST) interface. These devices can monitor their own temperature as well as the temperature of one (ADT7484A) or two (ADT7486A) remote sensor diodes. The ADT7484A/ADT7486A are controlled by a single SST bidirectional data line. The devices are fixed-address SST clients where the target address is chosen by the state of the two address pins, ADD0 and ADD1.

### Features

- 1 On-Chip Temperature Sensor
- 1 or 2 Remote Temperature Sensors
- Simple Serial Transport™ (SST™) Interface Rev 1 Compliant
- These are Pb-Free Devices

### Applications

- Personal Computers
- Portable Personal Devices
- Industrial Sensor Nets



**ON Semiconductor®**

<http://onsemi.com>

### MARKING DIAGRAMS



**SOIC-8  
CASE 751**

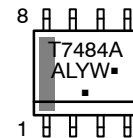

- A = Assembly Location
- L = Wafer Lot
- Y = Year
- W = Work Week
- = Pb-Free Package



**MSOP-8  
CASE 846AB**

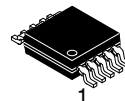
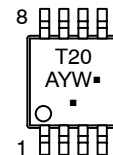

**MSOP-10  
CASE 846AC**

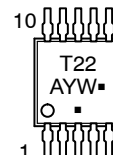

- T2x = Specific Device Code
- A = Assembly Location
- Y = Year
- W = Work Week
- = Pb-Free Package

(Note: Microdot may be in either location)

### PIN ASSIGNMENTS



(Top View)

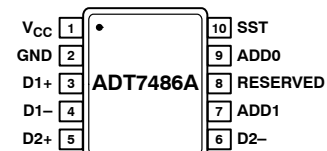

(Top View)

### ORDERING INFORMATION

See detailed ordering and shipping information in the package dimensions section on page 11 of this data sheet.

# ADT7484A/ADT7486A

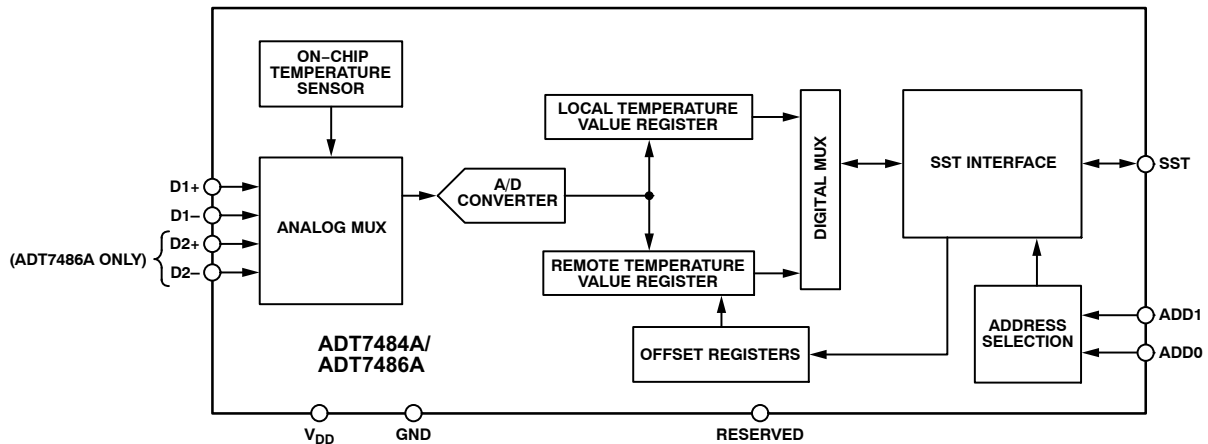

Figure 1. Functional Block Diagram

## ABSOLUTE MAXIMUM RATINGS

Parameter	Rating	Unit
Supply Voltage ( $V_{CC}$ )	3.6	V
Voltage on Any Other Pin (Including SST Pin)	3.6	V
Input Current at Any Pin	$\pm 5.0$	mA
Package Input Current	$\pm 20$	mA
Maximum Junction Temperature ( $T_J$ max)	150	$^{\circ}\text{C}$
Storage Temperature Range	-65 to +150	$^{\circ}\text{C}$
Lead Temperature, Soldering		$^{\circ}\text{C}$
IR Reflow Peak Temperature	260	
Lead Temperature, Soldering (10 sec)	300	
ESD Rating	1500	V

Stresses exceeding Maximum Ratings may damage the device. Maximum Ratings are stress ratings only. Functional operation above the Recommended Operating Conditions is not implied. Extended exposure to stresses above the Recommended Operating Conditions may affect device reliability.

NOTE: This device is ESD sensitive. Use standard ESD precautions when handling.

## THERMAL CHARACTERISTICS

Package Type	$\theta_{JA}$	$\theta_{JC}$	Unit
8-Lead MSOP and 8-Lead SOIC NB Packages (ADT7484A) 10-Lead MSOP (ADT7486A)	206	44	$^{\circ}\text{C}/\text{W}$

NOTE:  $\theta_{JA}$  is specified for the worst-case conditions, that is, a device soldered in a circuit board for surface-mount packages.

# ADT7484A/ADT7486A

## ADT7484A PIN ASSIGNMENT

Pin No.	Mnemonic	Type	Description
1	V <sub>CC</sub>	Power supply	3.3 V ± 10%.
2	GND	Ground	Ground Pin.
3	D1+	Analog input	Positive Connection to Remote Temperature Sensor.
4	D1-	Analog input	Negative Connection to Remote Temperature Sensor.
5	ADD1	Digital input	SST Address Select.
6	RESERVED	Reserved	Connect to Ground.
7	ADD0	Digital input	SST Address Select.
8	SST	Digital input/output	SST Bidirectional Data Line.

## ADT7486A PIN ASSIGNMENT

Pin No.	Mnemonic	Type	Description
1	V <sub>CC</sub>	Power supply	3.3 V ± 10%.
2	GND	Ground	Ground Pin.
3	D1+	Analog input	Positive Connection to Remote 1 Temperature Sensor.
4	D1-	Analog input	Negative Connection to Remote 1 Temperature Sensor.
5	D2+	Analog input	Positive Connection to Remote 2 Temperature Sensor.
6	D2-	Analog input	Negative Connection to Remote 2 Temperature Sensor.
7	ADD1	Analog input	SST Address Select.
8	RESERVED	Analog input	Connect to Ground.
9	ADD0	Digital input	SST Address Select.
10	SST	Digital input/output	SST Bidirectional Data Line.

## ELECTRICAL CHARACTERISTICS (T<sub>A</sub> = T<sub>MIN</sub> to T<sub>MAX</sub>, V<sub>CC</sub> = V<sub>MIN</sub> to V<sub>MAX</sub>, unless otherwise noted)

Parameter	Conditions	Min	Typ	Max	Unit
<b>Power Supply</b>					
Supply Voltage, V <sub>CC</sub>		3.0	3.3	3.6	V
Undervoltage Lockout Threshold			2.8		V
Average Operating Supply Current, I <sub>DD</sub>	Continuous conversions		3.8	5.0	mA
<b>Temperature-to-Digital Converter</b>					
Local Sensor Accuracy	40°C ≤ T <sub>A</sub> ≤ 70°C, V <sub>CC</sub> = 3.3 V ±5%		+1.0	±1.75	°C
	-40°C ≤ T <sub>A</sub> ≤ +100°C			±4.0	°C
Remote Sensor Accuracy	-40°C ≤ T <sub>D</sub> ≤ +125°C; T <sub>A</sub> = 25°C; V <sub>CC</sub> = 3.3 V			±1.0	°C
	-40°C ≤ T <sub>D</sub> ≤ +125°C; -40 ≤ T <sub>A</sub> ≤ 70°C, V <sub>CC</sub> = 3.3 V ±5%		+1.0	±1.75	°C
	-40°C ≤ T <sub>D</sub> ≤ +125°C; -40 ≤ T <sub>A</sub> ≤ +100°C			±4.0	°C
Remote Sensor Source Current	Low level Mid level High level		12 80 204		μA
Resolution			0.016		°C
Series Resistance Cancellation	The ADT7484A and ADT7486A cancel 1.5 kΩ in series with the remote thermal diode		1.5		kΩ

1. Guaranteed by design, not production tested.
2. Minimum and maximum bit times are relative to t<sub>BIT</sub> defined in the timing negotiation pulse.
3. Devices compatible with hold time specification as driven by SST originator.

# ADT7484A/ADT7486A

## ELECTRICAL CHARACTERISTICS ( $T_A = T_{MIN}$ to $T_{MAX}$ , $V_{CC} = V_{MIN}$ to $V_{MAX}$ , unless otherwise noted)

Parameter	Conditions	Min	Typ	Max	Unit
<b>Temperature-to-Digital Converter</b>					
Conversion Time (Local Temperature) (Note 1)	Averaging enabled		12	12	ms
Conversion Time (Remote Temperature) (Note 1)	Averaging enabled			38	ms
Total Monitoring Cycle Time (Note 1)	Averaging enabled			50	ms

### Digital Inputs (ADD0, ADD1)

Input High Voltage, $V_{IH}$		2.3			V
Input Low Voltage, $V_{IL}$				0.8	V
Input High Current, $I_{IH}$	$V_{IN} = V_{CC}$	-1.0			$\mu A$
Input Low Current, $I_{IL}$	$V_{IN} = 0$			1.0	$\mu A$
Pin Capacitance			5.0		pF

### Digital I/O (SST Pin)

Input High Voltage, $V_{IH}$		1.1			V
Input Low Voltage, $V_{IL}$				0.4	V
Hysteresis (Note 1)	Between input switching levels		150		mV
Output High Voltage, $V_{OH}$	$I_{SOURCE} = 6$ mA (maximum)	1.1		1.9	V
High Impedance State Leakage, $I_{LEAK}$	Device powered on SST bus; $V_{SST} = 1.1$ V, $V_{CC} = 3.3$ V			$\pm 1.0$	$\mu A$
High Impedance State Leakage, $I_{LEAK}$	Device unpowered on SST bus; $V_{SST} = 1.1$ V, $V_{CC} = 0$ V			$\pm 10$	$\mu A$
Signal Noise Immunity, $V_{NOISE}$	Noise glitches from 10 MHz to 100 MHz; width up to 50 ns	300			mV p-p

### SST Timing

Bitwise Period, $t_{BIT}$		0.495		500	$\mu s$
High Level Time for Logic 1, $t_{H1}$ (Note 2)	$t_{BIT}$ defined in speed negotiation	$0.6 \times t_{BIT}$	$0.75 \times t_{BIT}$	$0.8 \times t_{BIT}$	$\mu s$
High Level Time for Logic 0, $t_{H0}$ (Note 2)		$0.2 \times t_{BIT}$	$0.25 \times t_{BIT}$	$0.4 \times t_{BIT}$	$\mu s$
Time to Assert SST High for Logic 1, $t_{SU, HIGH}$				$0.2 \times t_{BIT}$	$\mu s$
Hold Time, $t_{HOLD}$ (Note 3)	See SST Specification Rev 1.0			$0.5 \times t_{BIT-M}$	$\mu s$
Stop Time, $t_{STOP}$	Device responding to a constant low level driven by originator	$1.25 \times t_{BIT}$	$2 \times t_{BIT}$	$2 \times t_{BIT}$	$\mu s$
Time to Respond After a Reset, $t_{RESET}$				0.4	ms
Response Time to Speed Negotiation After Powerup	Time after powerup when device can participate in speed negotiation		500		$\mu s$

1. Guaranteed by design, not production tested.
2. Minimum and maximum bit times are relative to  $t_{BIT}$  defined in the timing negotiation pulse.
3. Devices compatible with hold time specification as driven by SST originator.

TYPICAL CHARACTERISTICS

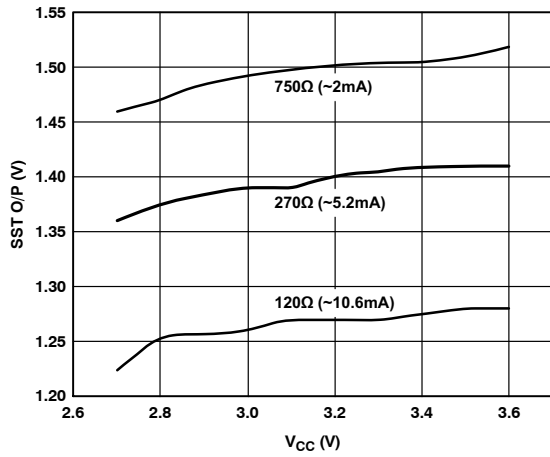

Figure 2. SST O/P Level vs. Supply Voltage

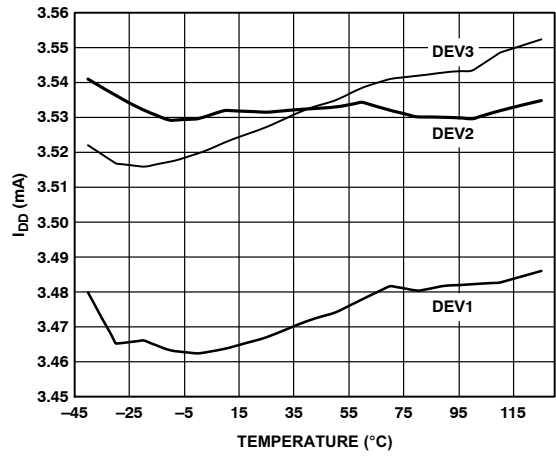

Figure 3. Supply Current vs. Temperature

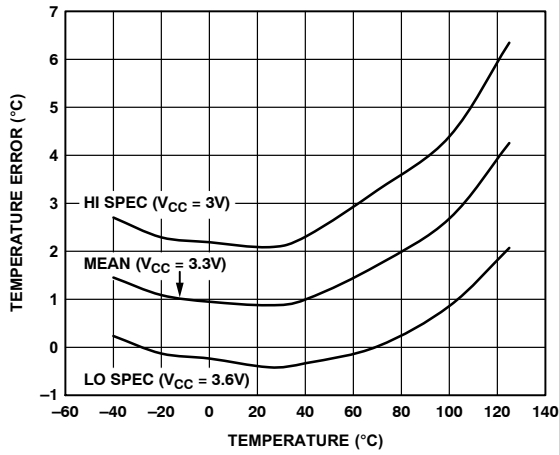

Figure 4. Local Temperature Error

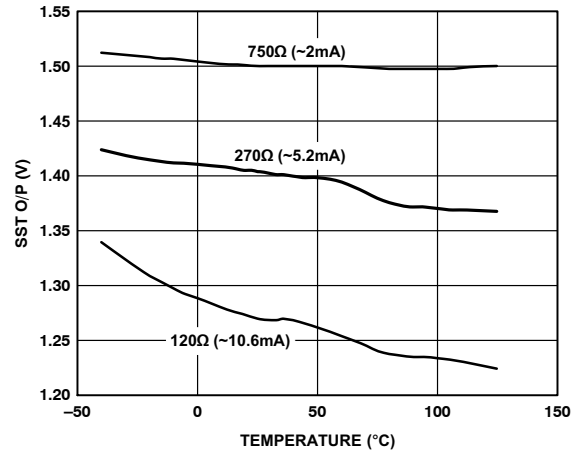

Figure 5. SST O/P Level vs. Temperature

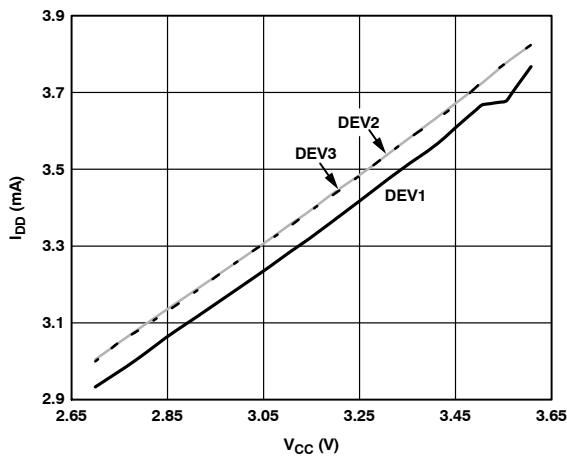

Figure 6. Supply Current vs. Voltage

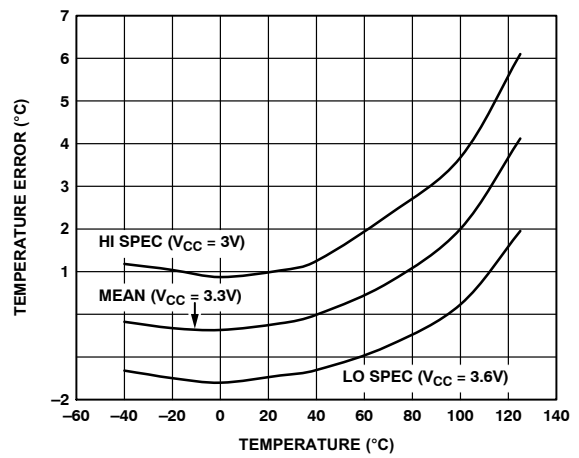

Figure 7. Remote Temperature Error

TYPICAL CHARACTERISTICS

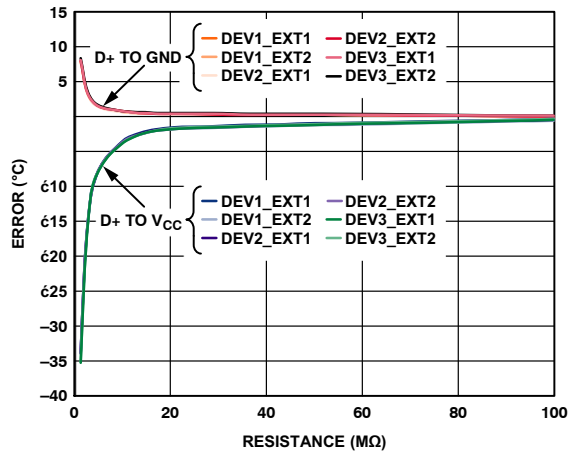

Figure 8. Remote Temperature Error vs. PCB Resistance

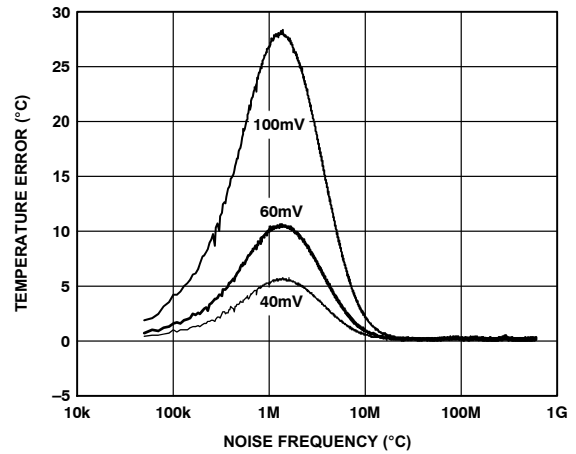

Figure 9. Temperature Error vs. Common-Mode Noise Frequency

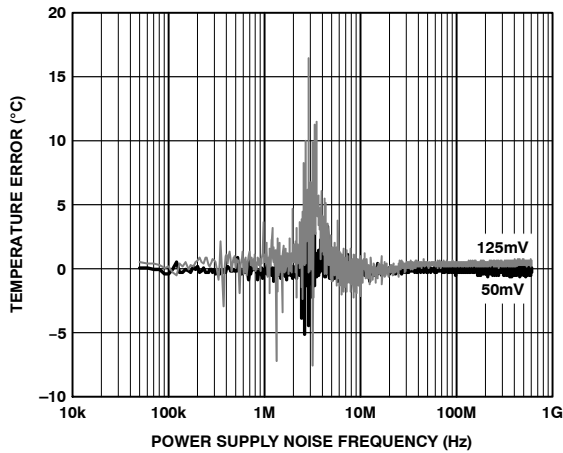

Figure 10. Local Temperature Error vs. Power Supply Noise

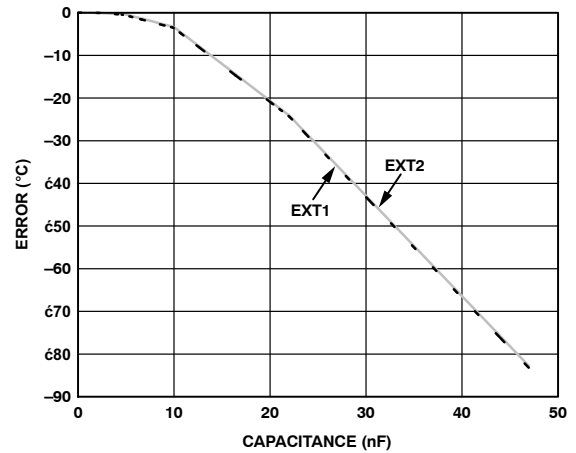

Figure 11. Remote Temperature Error vs. Capacitance Between D1+ and D1-

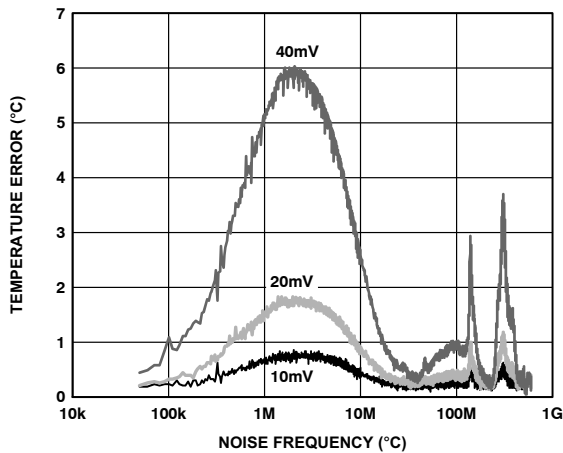

Figure 12. Temperature Error vs. Differential-Mode Noise Frequency

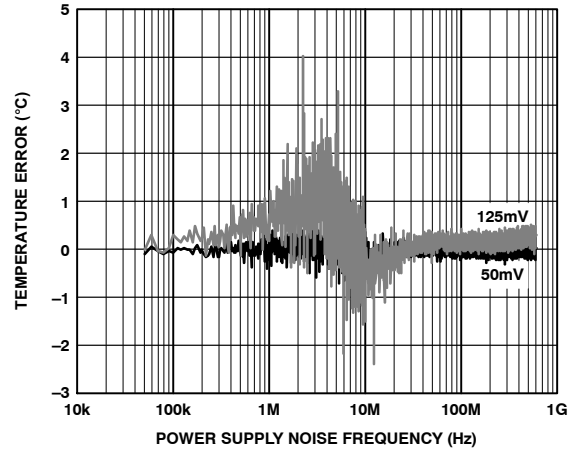

Figure 13. Remote Temperature Error vs. Power Supply Noise

# ADT7484A/ADT7486A

## Product Description

The ADT7484A is a single remote temperature sensor, and the ADT7486A is a dual temperature sensor for use in PC applications. The ADT7484A/ADT7486A accurately measure local and remote temperature and communicate over a one-wire Simple Serial Transport (SST) bus interface.

## SST Interface

Simple Serial Transport (SST) is a one-wire serial bus and a communications protocol between components intended for use in personal computers, personal handheld devices, or other industrial sensor nets. The ADT7484A/ADT7486A support SST specification Rev 1.

SST is a licensable bus technology from Analog Devices, Inc., and Intel Corporation. To inquire about obtaining a copy of the Simple Serial Transport Specification or an SST technology license, please email Analog Devices, at [sss\\_licensing@analog.com](mailto:sss_licensing@analog.com) or write to Analog Devices, 3550 North First Street, San Jose, CA 95134, Attention: SST Licensing, M/S B7-24.

## ADT7484A/ADT7486A Client Address

The client address for the ADT7484A/ADT7486A is selected using the address pin. The address pin is connected to a float detection circuit, which allows the ADT7484A/

ADT7486A to distinguish between three input states: high, low (GND), and floating. The address range for fixed address, discoverable devices is 0x48 to 0x50.

**Table 1. ADT7484A/ADT7486A Selectable Addresses**

ADD1	ADD0	Address Selected
Low (GND)	Low (GND)	0x48
Low (GND)	Float	0x49
Low (GND)	High	0x4A
Float	Low (GND)	0x4B
Float	Float	0x4C
Float	High	0x4D
High	Low (GND)	0x4E
High	Float	0x4F
High	High	0x50

## Command Summary

Table 7 summarizes the commands supported by the ADT7484A/ADT7486A devices when directed at the target address selected by the fixed address pins. It contains the command name, command code (CC), write data length (WL), read data length (RL), and a brief description.

**Table 2. Command Code Summary**

Command	Command Code, CC	Write Length, WL	Read Length, RL	Description
Ping()	0x00	0x00	0x00	Shows a nonzero FCS over the header if present.
GetIntTemp()	0x00	0x01	0x02	Shows the temperature of the device's internal thermal diode.
GetExt1Temp()	0x01	0x01	0x02	Shows the temperature of External Thermal Diode 1.
GetExt2Temp()	0x02	0x01	0x02	Shows the temperature of External Thermal Diode 2 (ADT7486A only).
GetAllTemps()	0x00	0x01	0x04 (ADT7484A) 0x06 (ADT7486A)	Shows a 4- or 6-byte block of data (ADT7484A: GetIntTemp, GetExt1Temp; ADT7486A: GetIntTemp, GetExt1Temp, GetExt2Temp).
SetExt1Offset()	0xe0	0x03	0x00	Sets the offset used to correct errors in External Diode 1.
GetExt1Offset()	0xe0	0x01	0x02	Shows the offset that the device is using to correct errors in External Diode 1.
SetExt2Offset()	0xe1	0x03	0x00	Sets the offset used to correct errors in External Diode 2 (ADT7486A only).
GetExt2Offset()	0xe1	0x01	0x02	Shows the offset that the device is using to correct errors in External Diode 2 (ADT7486A only).
ResetDevice()	0xf6	0x01	0x00	Functional reset. The ADT7484A/ADT7486A also respond to this command when directed to the Target Address 0x00.
GetDIB()	0xf7 0xf7	0x01 0x01	0x08 0x10	Shows information used by SW to identify the device's capabilities. Can be in 8- or 16-byte format.

**Command Code Details**

**ADT7484A/ADT7486A Device Identifier Block**

The GetDIB() command retrieves the device identifier block (DIB), which provides information to identify the capabilities of the ADP7484A/ADT7486A. The data returned can be in 8- or 16-byte format. The full 16-bytes of DIB is detailed in Table 3. The 8-byte format involves the first eight bytes described in this table. Byte-sized data is returned in the respective fields as it appears in Table 3. Word-sized data, including vendor ID, device ID, and data values use little endian format, that is, the LSB is returned first, followed by the MSB.

**Table 3. DIB Byte Details**

Byte	Name	Value	Description
0	Device Capabilities	0xc0	Fixed address device
1	Version/ Revision	0x10	Meets Version 1 of the SST specification
2, 3	Vendor ID	00x11d4	Contains company ID number in little endian format
4, 5	Device ID	0x7484 or 0x7486	Contains device ID number in little endian format
6	Device Interface	0x01	SST device
7	Function Interface	0x00	Reserved
8	Reserved	0x00	Reserved
9	Reserved	0x00	Reserved
10	Reserved	0x00	Reserved
11	Reserved	0x00	Reserved
12	Reserved	0x00	Reserved
13	Reserved	0x00	Reserved
14	Revision ID	0x05	Contains revision ID
15	Client Device Address	0x48 to 0x50	Dependent on the state of the address pins

**Ping()**

The Ping() command verifies if a device is responding at a particular address. The ADT7484A/ADT7486A show a valid nonzero FCS in response to the Ping() command when correctly addressed.

**Table 4. Ping() Command**

Target Address	Write Length	Read Length	FCS
Device Address	0x00	0x00	

**ResetDevice()**

This command resets the register map and conversion controller. The reset command can be global or directed at the client address of the ADT7484A/ADT7486A.

**Table 5. Reset Device() Command**

Target Address	Write Length	Read Length	Reset Command	FCS
Device Address	0x01	0x00	0xf6	

**GetIntTemp()**

The ADT7484A/ADT7486A show the local temperature of the device in response to the GetIntTemp() command. The data has a little endian, 16-bit, twos complement format.

**GetExtTemp()**

Prompted by the GetExtTemp() command, the ADT7484A/ADT7486A show the temperature of the remote diode in little endian, 16-bit, twos complement format. The ADT7484A/ADT7486A show 0x8000 in response to this command if the external diode is an open or short circuit.

**GetAllTemps()**

The ADT7484A shows the local and remote temperatures in a 4-byte block of data (internal temperature first, followed by External Temperature 1) in response to a GetAllTemps() command. The ADT7486A shows the local and remote temperatures in a 6-byte block of data (internal temperature first, followed by External Temperature 1 and External Temperature 2) in response to this command.

**SetExtOffset()**

This command sets the offset that the ADT7484A/ADT7486A will use to correct errors in the external diode. The offset is set in little endian, 16-bit, twos complement format. The maximum offset is ±128°C with +0.25°C resolution.

**GetExtOffset()**

This command causes the ADT7484A/ADT7486A to show the offset that they are using to correct errors in the external diode. The offset value is returned in little endian format, that is, LSB before MSB.

**ADT7484A/ADT7486A Response to Unsupported Commands**

A full list of command codes supported by the ADT7484A/ADT7486A is given in Table 7. The offset registers (Command Codes 0xe0 and 0xe1) are the only registers that the user can write to. The other defined registers are read only. Writing to Register Addresses 0x03 to 0xdf shows a valid FSC, but no action is taken by the ADT7484A/ADT7486A. The ADT7484A/ADT7486A show an invalid FSC if the user attempts to write to the devices between Command Codes 0xe2 to 0xee and no data is written to the device. These registers are reserved for the manufacturer’s use only, and no data can be written to the device via these addresses.

**Temperature Measurement**

The ADT7484A/ADT7486A each have two dedicated temperature measurement channels: one for measuring the temperature of an on-chip band gap temperature sensor, and one for measuring the temperature of a remote diode, usually located in the CPU or GPU.

The ADT7484A monitors one local and one remote temperature channel, whereas the ADT7486A monitors one local and two remote temperature channels. Monitoring of each of the channels is done in a round-robin sequence. The monitoring sequence is in the order shown in Table 11.

**Table 6. Temperature Monitoring Sequence**

Channel Number	Measurement	Conversion Time (ms)
0	Local Temperature	12
1	Remote Temperature 1	38
2	Remote Temperature 2 (ADT7486A only)	38

**Temperature Measurement Method**

A simple method for measuring temperature is to exploit the negative temperature coefficient of a diode by measuring the base-emitter voltage ( $V_{BE}$ ) of a transistor operated at constant current. Unfortunately, this technique requires calibration to null the effect of the absolute value of  $V_{BE}$ , which varies from device to device.

The technique used in the ADT7484A/ADT7486A measures the change in  $V_{BE}$  when the device is operated at three different currents.

Figure 16 shows the input signal conditioning used to measure the output of a remote temperature sensor. This figure shows the remote sensor as a substrate transistor, which is provided for temperature monitoring on some microprocessors, but it could also be a discrete transistor. If a discrete transistor is used, the collector is not grounded and should be linked to the base. To prevent ground noise from interfering with the measurement, the more negative terminal of the sensor is not referenced to ground, but is biased above ground by an internal diode at the D1- input. If the sensor is operating in an extremely noisy environment, C1 can be added as a noise filter. Its value should not exceed 1000 pF.

To measure  $\Delta V_{BE}$ , the operating current through the sensor is switched between three related currents. Figure 16 shows  $N1 \times I$  and  $N2 \times I$  as different multiples of the current  $I$ . The currents through the temperature diode are switched between  $I$  and  $N1 \times I$ , giving  $\Delta V_{BE1}$ , and then between  $I$  and  $N2 \times I$ , giving  $\Delta V_{BE2}$ . The temperature can then be

calculated using the two  $\Delta V_{BE}$  measurements. This method can also cancel the effect of series resistance on the temperature measurement. The resulting  $\Delta V_{BE}$  waveforms are passed through a 65 kHz low-pass filter to remove noise and then through a chopper-stabilized amplifier to amplify and rectify the waveform, producing a dc voltage proportional to  $\Delta V_{BE}$ . The ADC digitizes this voltage, and a temperature measurement is produced. To reduce the effects of noise, digital filtering is performed by averaging the results of 16 measurement cycles for low conversion rates. Signal conditioning and measurement of the internal temperature sensor is performed in the same manner.

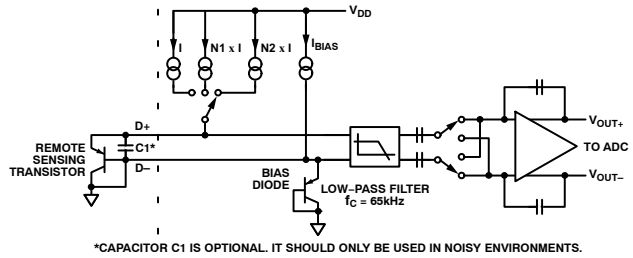

**Figure 14. Signal Conditioning for Remote Diode Temperature Sensors**

**Reading Temperature Measurements**

The temperature measurement command codes are detailed in Table 12. The temperature data returned is two bytes in little endian format, that is, LSB before MSB. All temperatures can be read together by using Command Code 0x00 with a read length of 0x04. The command codes and returned data are described in Table 12.

**Table 7. Temperature Channel Command Codes**

Temp Channel	Command Code	Returned Data
Internal	0x00	LSB, MSB
External 1	0x01	LSB, MSB
External 2	0x02	LSB, MSB
All Temps	0x00	Internal LSB, Internal MSB; External 1 LSB, External 1 MSB; External 2 LSB, External 2 MSB

**SST Temperature Sensor Data Format**

The data for temperature is structured to allow values in the range of  $\pm 512^{\circ}\text{C}$  to be reported. Thus, the temperature sensor format uses a twos complement, 16-bit binary value to represent values in this range. This format allows temperatures to be represented with approximately a  $0.016^{\circ}\text{C}$  resolution.

**Table 8. SST Temperature Data Format**

Temperature ( $^{\circ}\text{C}$ )	Twos Complement	
	MSB	LSB
-125	1110 0000	1100 0000
-80	1110 1100	0000 0000
-40	1111 0110	0000 0000
-20	1111 1011	0011 1110
-5	1111 1110	1100 0000
-1	1111 1111	1100 0000
0	0000 0000	0000 0000
+1	0000 0000	0100 0000
+5	0000 0001	0100 0000
+20	0000 0100	1100 0010
+40	0000 1010	0000 0000
+80	0001 0100	0000 0000
+125	0001 1111	0100 0000

**Using Discrete Transistors**

If a discrete transistor is used, the collector is not grounded and should be linked to the base. If a PNP transistor is used, the base is connected to the D1- input and the emitter is connected to the D1+ input. If an NPN transistor is used, the emitter is connected to the D1- input and the base is connected to the D1+ input. Figure 17 shows how to connect the ADT7484A/ADT7486A to an NPN or PNP transistor for temperature measurement. To prevent ground noise from interfering with the measurement, the more negative terminal of the sensor is not referenced to ground, but is biased above ground by an internal diode at the D1- input.

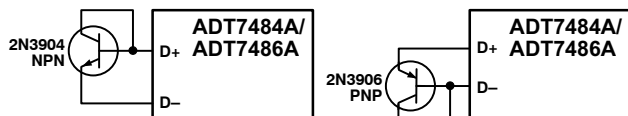

**Figure 15. Connections for NPN and PNP Transistors**

The ADT7484A/ADT7486A show an external temperature value of 0x8000 if the external diode is an open or short circuit.

**Layout Considerations**

Digital boards can be electrically noisy environments. Take the following precautions to protect the analog inputs from noise, particularly when measuring the very small voltages from a remote diode sensor:

- Place the device as close as possible to the remote sensing diode. Provided that the worst noise sources,

such as clock generators, data/address buses, and CRTs, are avoided, this distance can be four to eight inches.

- Route the D1+ and D1- tracks close together in parallel with grounded guard tracks on each side. Provide a ground plane under the tracks if possible.
- Use wide tracks to minimize inductance and reduce noise pickup. A 5 mil track minimum width and spacing is recommended.



**Figure 16. Arrangements of Signal Tracks**

- Try to minimize the number of copper/solder joints, which can cause thermocouple effects. Where copper/solder joints are used, make sure that they are in both the D1+ and D1- paths and are at the same temperature.
- Thermocouple effects should not be a major problem because  $1^{\circ}\text{C}$  corresponds to about  $240\ \mu\text{V}$ , and thermocouple voltages are about  $3\ \mu\text{V}/^{\circ}\text{C}$  of the temperature difference. Unless there are two thermocouples with a big temperature differential between them, thermocouple voltages should be much less than 200 mV.
- Place a  $0.1\ \mu\text{F}$  bypass capacitor close to the device.
- If the distance to the remote sensor is more than eight inches, the use of a twisted-pair cable is recommended. This works for distances of about 6 to 12 feet.
- For very long distances (up to 100 feet), use shielded twisted-pair cables, such as Belden #8451 microphone cables. Connect the twisted-pair cable to D1+ and D1- and the shield to GND, close to the device. Leave the remote end of the shield unconnected to avoid ground loops.

Because the measurement technique uses switched current sources, excessive cable and/or filter capacitance can affect the measurement. When using long cables, the filter capacitor can be reduced or removed. Cable resistance can also introduce errors. A  $1\ \Omega$  series resistance introduces about  $0.5^{\circ}\text{C}$  error.

# ADT7484A/ADT7486A

## Temperature Offset

As CPUs run faster, it is more difficult to avoid high frequency clocks when running the D1+ and D1- tracks around a system board. Even when the recommended layout guidelines are followed, there may still be temperature errors, attributed to noise being coupled on to the D1+ and D1- lines. High frequency noise generally has the effect of producing temperature measurements that are consistently too high by a specific amount. The ADT7484A/ADT87486A have a temperature offset command code of 0xe0 through which a desired offset can be set. By doing a one-time calibration of the system, the offset caused by system board noise can be calculated and nulled by specifying it in the ADT7484A/ADT7486A. The offset is automatically added to every temperature measurement. The maximum offset is  $\pm 128^{\circ}\text{C}$  with  $0.25^{\circ}\text{C}$  resolution. The offset format is the same as the temperature data format; 16-bit, twos complement notation, as shown in Table 8. The offset should be programmed in little endian format, that is, LSB before MSB. The offset value is also returned in little endian format when read.

## Application Schematics

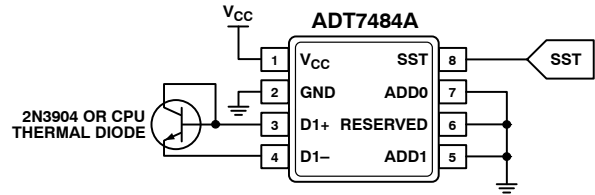

Figure 17. ADT7484A Typical Application Schematic

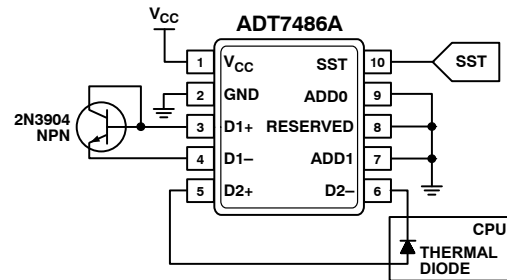

Figure 18. ADT7486A Typical Application Schematic

## ORDERING INFORMATION

Device Order Number*	Branding	Package Option	Package Type	Shipping†
ADT7484AARZ-REEL	-	R-8	SOIC-8 NB	2500 Tape & Reel
ADT7484AARZ-RL7	-	R-8	SOIC-8 NB	1000 Tape & Reel
ADT7484AARMZ-RL	T20	RM-8	8-Lead MSOP	3000 Tape & Reel
ADT7484AARMZ-R7	T20	RM-8	8-Lead MSOP	1000 Tape & Reel
ADT7486AARMZ-RL	T22	RM-10	10-Lead MSOP	3000 Tape & Reel
ADT7486AARMZ-R7	T22	RM-10	10-Lead MSOP	1000 Tape & Reel

†For information on tape and reel specifications, including part orientation and tape sizes, please refer to our Tape and Reel Packaging Specifications Brochure, BRD8011/D.

\*These are Pb-Free packages.

# ADT7484A/ADT7486A

## PACKAGE DIMENSIONS

SOIC-8 NB  
CASE 751-07  
ISSUE AJ

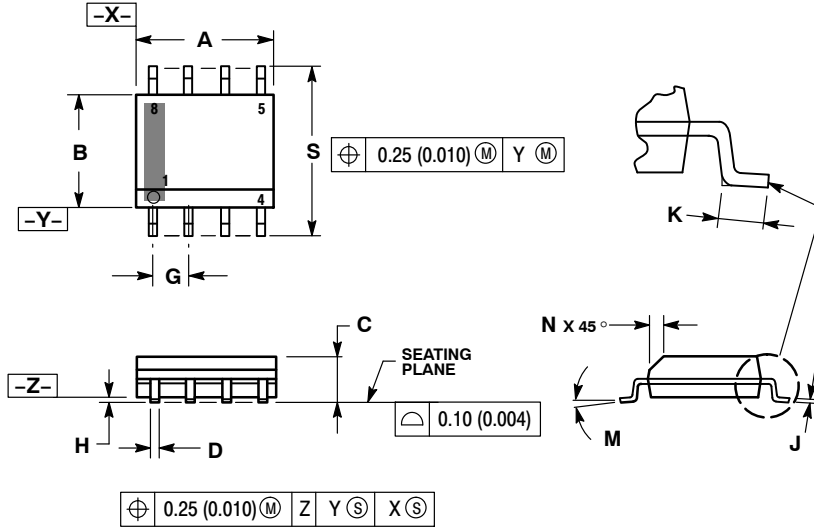

### NOTES:

1. DIMENSIONING AND TOLERANCING PER ANSI Y14.5M, 1982.
2. CONTROLLING DIMENSION: MILLIMETER.
3. DIMENSION A AND B DO NOT INCLUDE MOLD PROTRUSION.
4. MAXIMUM MOLD PROTRUSION 0.15 (0.006) PER SIDE.
5. DIMENSION D DOES NOT INCLUDE DAMBAR PROTRUSION. ALLOWABLE DAMBAR PROTRUSION SHALL BE 0.127 (0.005) TOTAL IN EXCESS OF THE D DIMENSION AT MAXIMUM MATERIAL CONDITION.
6. 751-01 THRU 751-06 ARE OBSOLETE. NEW STANDARD IS 751-07.

DIM	MILLIMETERS		INCHES	
	MIN	MAX	MIN	MAX
A	4.80	5.00	0.189	0.197
B	3.80	4.00	0.150	0.157
C	1.35	1.75	0.053	0.069
D	0.33	0.51	0.013	0.020
G	1.27 BSC		0.050 BSC	
H	0.10	0.25	0.004	0.010
J	0.19	0.25	0.007	0.010
K	0.40	1.27	0.016	0.050
M	0°	8°	0°	8°
N	0.25	0.50	0.010	0.020
S	5.80	6.20	0.228	0.244

### SOLDERING FOOTPRINT\*

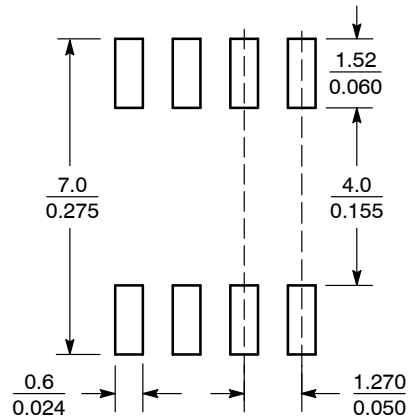

SCALE 6:1  $\left(\frac{\text{mm}}{\text{inches}}\right)$

\*For additional information on our Pb-Free strategy and soldering details, please download the ON Semiconductor Soldering and Mounting Techniques Reference Manual, SOLDERRM/D.

# ADT7484A/ADT7486A

## PACKAGE DIMENSIONS

MSOP8  
CASE 846AB-01  
ISSUE O

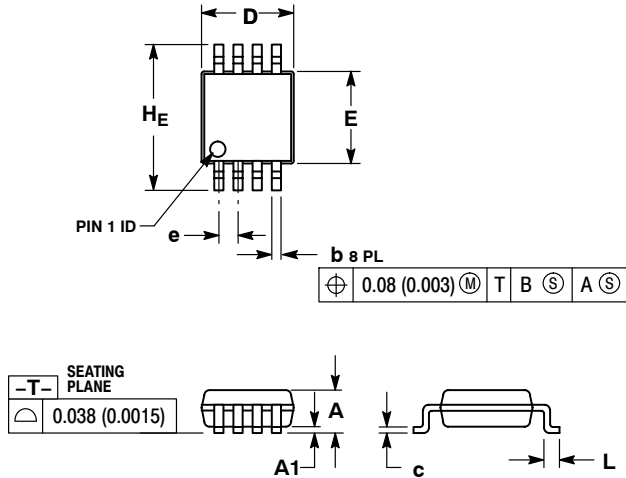

NOTES:

1. DIMENSIONING AND TOLERANCING PER ANSI Y14.5M, 1982.
2. CONTROLLING DIMENSION: MILLIMETER.
3. DIMENSION A DOES NOT INCLUDE MOLD FLASH, PROTRUSIONS OR GATE BURRS. MOLD FLASH, PROTRUSIONS OR GATE BURRS SHALL NOT EXCEED 0.15 (0.006) PER SIDE.
4. DIMENSION B DOES NOT INCLUDE INTERLEAD FLASH OR PROTRUSION. INTERLEAD FLASH OR PROTRUSION SHALL NOT EXCEED 0.25 (0.010) PER SIDE.
5. 846A-01 OBSOLETE, NEW STANDARD 846A-02.

DIM	MILLIMETERS			INCHES		
	MIN	NOM	MAX	MIN	NOM	MAX
A	--	--	1.10	--	--	0.043
A1	0.05	0.08	0.15	0.002	0.003	0.006
b	0.25	0.33	0.40	0.010	0.013	0.016
c	0.13	0.18	0.23	0.005	0.007	0.009
D	2.90	3.00	3.10	0.114	0.118	0.122
E	2.90	3.00	3.10	0.114	0.118	0.122
e	0.65 BSC			0.026 BSC		
L	0.40	0.55	0.70	0.016	0.021	0.028
HE	4.75	4.90	5.05	0.187	0.193	0.199

### SOLDERING FOOTPRINT\*

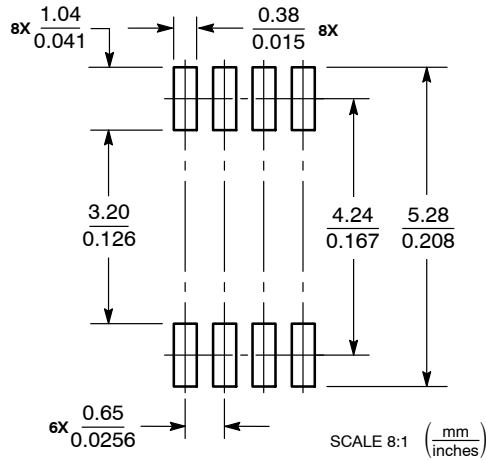

\*For additional information on our Pb-Free strategy and soldering details, please download the ON Semiconductor Soldering and Mounting Techniques Reference Manual, SOLDERRM/D.

# ADT7484A/ADT7486A

## PACKAGE DIMENSIONS

MSOP10  
CASE 846AC-01  
ISSUE O

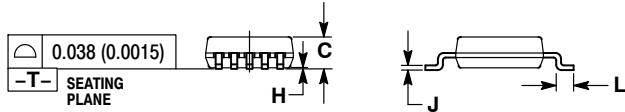
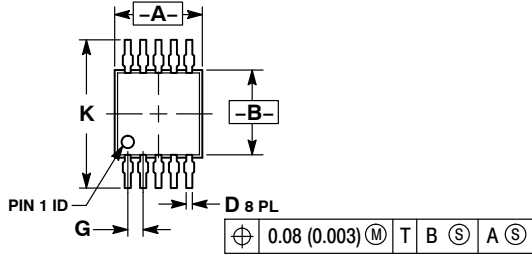

NOTES:

1. DIMENSIONING AND TOLERANCING PER ANSI Y14.5M, 1982.
2. CONTROLLING DIMENSION: MILLIMETER.
3. DIMENSION "A" DOES NOT INCLUDE MOLD FLASH, PROTRUSIONS OR GATE BURRS. MOLD FLASH, PROTRUSIONS OR GATE BURRS SHALL NOT EXCEED 0.15 (0.006) PER SIDE.
4. DIMENSION "B" DOES NOT INCLUDE INTERLEAD FLASH OR PROTRUSION. INTERLEAD FLASH OR PROTRUSION SHALL NOT EXCEED 0.25 (0.010) PER SIDE.
5. 846B-01 OBSOLETE. NEW STANDARD 846B-02

DIM	MILLIMETERS		INCHES	
	MIN	MAX	MIN	MAX
A	2.90	3.10	0.114	0.122
B	2.90	3.10	0.114	0.122
C	0.95	1.10	0.037	0.043
D	0.20	0.30	0.008	0.012
G	0.50 BSC		0.020 BSC	
H	0.05	0.15	0.002	0.006
J	0.10	0.21	0.004	0.008
K	4.75	5.05	0.187	0.199
L	0.40	0.70	0.016	0.028

### SOLDERING FOOTPRINT\*

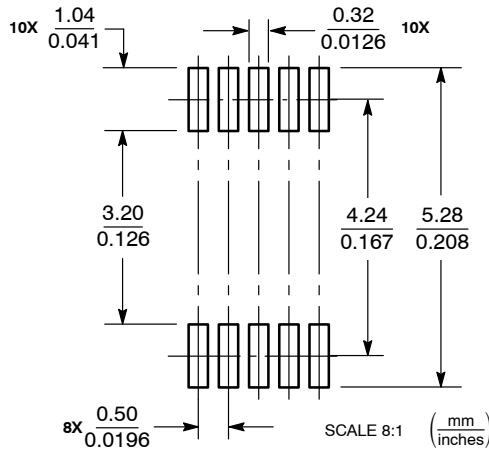

\*For additional information on our Pb-Free strategy and soldering details, please download the ON Semiconductor Soldering and Mounting Techniques Reference Manual, SOLDERRM/D.

ON Semiconductor and are registered trademarks of Semiconductor Components Industries, LLC (SCILLC). SCILLC reserves the right to make changes without further notice to any products herein. SCILLC makes no warranty, representation or guarantee regarding the suitability of its products for any particular purpose, nor does SCILLC assume any liability arising out of the application or use of any product or circuit, and specifically disclaims any and all liability, including without limitation special, consequential or incidental damages. "Typical" parameters which may be provided in SCILLC data sheets and/or specifications can and do vary in different applications and actual performance may vary over time. All operating parameters, including "Typicals" must be validated for each customer application by customer's technical experts. SCILLC does not convey any license under its patent rights nor the rights of others. SCILLC products are not designed, intended, or authorized for use as components in systems intended for surgical implant into the body, or other applications intended to support or sustain life, or for any other application in which the failure of the SCILLC product could create a situation where personal injury or death may occur. Should Buyer purchase or use SCILLC products for any such unintended or unauthorized application, Buyer shall indemnify and hold SCILLC and its officers, employees, subsidiaries, affiliates, and distributors harmless against all claims, costs, damages, and expenses, and reasonable attorney fees arising out of, directly or indirectly, any claim of personal injury or death associated with such unintended or unauthorized use, even if such claim alleges that SCILLC was negligent regarding the design or manufacture of the part. SCILLC is an Equal Opportunity/Affirmative Action Employer. This literature is subject to all applicable copyright laws and is not for resale in any manner.

### PUBLICATION ORDERING INFORMATION

LITERATURE FULFILLMENT:  
Literature Distribution Center for ON Semiconductor  
P.O. Box 5163, Denver, Colorado 80217 USA  
Phone: 303-675-2175 or 800-344-3860 Toll Free USA/Canada  
Fax: 303-675-2176 or 800-344-3867 Toll Free USA/Canada  
Email: orderlit@onsemi.com

N. American Technical Support: 800-282-9855 Toll Free  
USA/Canada  
Europe, Middle East and Africa Technical Support:  
Phone: 421 33 790 2910  
Japan Customer Focus Center  
Phone: 81-3-5773-3850

ON Semiconductor Website: [www.onsemi.com](http://www.onsemi.com)  
Order Literature: <http://www.onsemi.com/orderlit>  
For additional information, please contact your local Sales Representative

ADT7484A-86A/D