

### FEATURES

1. Compact DIP type SSR that's ideal for AC load control
2. Supports 0.3 A, 0.6 A, 0.9 A and 1.2 A ON-state RMS currents.
3. The 1.2 A type saves space with a DIP 8-pin package.

5. High dielectric strength: 5,000 V AC (between input and output)
6. Two types available: Zero-cross type and Random type

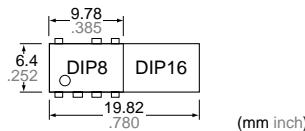

### 4. Handles both 100 and 200 V AC loads

This relay handles both voltages in a single product. It is not necessary for users that use both types to manage separate part numbers.

### TYPICAL APPLICATIONS

1. Home appliances (air conditioner, microwave oven, washing machine, personal hygiene system, refrigerator, fan heater, inductive heating cooker, rice cooker and humidifier, etc.)
2. Industrial equipment

### TYPES

Type	Output rating*		Type	Part No.				Packing quantity	
				Through hole terminal	Surface-mount terminal			Tube	Tape and reel
	Repetitive peak OFF-state voltage	ON-state RMS current			Tube packing style		Tape and reel packing style		
AC type			600 V	0.3 A	Zero-cross	AQH0213	AQH0213A	AQH0213AX	AQH0213AZ
	0.6 A	AQH1213		AQH1213A		AQH1213AX	AQH1213AZ		
	0.9 A	AQH2213		AQH2213A		AQH2213AX	AQH2213AZ		
	1.2 A	AQH3213		AQH3213A		AQH3213AX	AQH3213AZ		
	0.3 A	Random		AQH0223	AQH0223A	AQH0223AX	AQH0223AZ		
	0.6 A			AQH1223	AQH1223A	AQH1223AX	AQH1223AZ		
	0.9 A			AQH2223	AQH2223A	AQH2223AX	AQH2223AZ		
	1.2 A			AQH3223	AQH3223A	AQH3223AX	AQH3223AZ		

\*Indicate the repetitive peak OFF-state voltage and ON-state RMS current: peak AC.  
Note: For space reasons, the SMD terminal shape indicator "A" and the package type indicator "X" and "Z" are omitted from the seal.

### RATING

#### 1. Absolute maximum ratings (Ambient temperature: 25°C 77°F)

Item		Symbol	AQH0213, AQH0223	AQH1213, AQH1223	AQH2213, AQH2223	AQH3213, AQH3223	Remarks
Input	LED forward current	$I_F$	50 mA				
	LED reverse voltage	$V_R$	6 V				
	Peak forward current	$I_{FP}$	1 A				f = 100 Hz, Duty Ratio = 0.1%
Output	Repetitive peak OFF-state voltage	$V_{DRM}$	600 V				
	ON-state RMS current	$I_{T(RMS)}$	0.3 A	0.6 A	0.9 A	1.2 A	
	Non-repetitive surge current	$I_{TSM}$	3 A	6 A	9 A	12 A	60Hz, 1 cycle
I/O isolation voltage		$V_{ISO}$	5,000 V AC				
Temperature limits	Operating	$T_{opr}$	-30°C to +85°C -22°F to +185°F				Non-condensing at low temperatures
	Storage	$T_{stg}$	-40°C to +125°C -40°F to +257°F				

Note: "A", "AX" and "AZ" at the end of the part numbers have been omitted.

# AQ-H

## 2. Electrical characteristics (Ambient temperature: 25°C 77°F)

Item		Symbol	AQH0213, AQH1213, AQH2213, AQH3213	AQH0223, AQH1223, AQH2223, AQH3223	Condition
Input	LED dropout voltage	Typical	1.21 V		$I_F = 20 \text{ mA}$
		Maximum	1.3 V		
	LED reverse current	Typical	—		$V_R = 6 \text{ V}$
		Maximum	10 $\mu\text{A}$		
Output	Peak OFF-state current	Typical	—		$I_F = 0 \text{ mA}$ $V_{\text{DRM}} = 600 \text{ V}$
		Maximum	100 $\mu\text{A}$		
	Peak ON-state voltage	Typical	—		$I_F = 10 \text{ mA}$ $I_{\text{TM}} = \text{Max.}$
		Maximum	2.5 V		
	Holding current	Typical	—		
		Maximum	25 mA		
Critical rate of rise of OFF-state voltage	Minimum	dv/dt	200 V/ $\mu\text{s}$		$V_{\text{DRM}} = 600 \text{ V} \times 1/M2$
Transfer characteristics	Trigger LED current	Maximum	$I_{\text{FT}}$	10 mA	$V_D = 6 \text{ V}$ $R_L = 100 \Omega$
	Zero-cross voltage	Maximum	$V_{\text{ZC}}$	50 V	$I_F = 10 \text{ mA}$
	Turn on time*	Maximum	$T_{\text{ON}}$	100 $\mu\text{s}$	$I_F = 20 \text{ mA}$ $V_D = 6 \text{ V}$ $R_L = 100 \Omega$
	I/O isolation resistance	Minimum	$R_{\text{ISO}}$	50 G $\Omega$	500 V DC

Notes: 1. For type of connection, see page 3.  
2. "A", "AX" and "AZ" at the end of the part numbers have been omitted.

### RECOMMENDED OPERATING CONDITIONS

Please follow the conditions below in order to ensure accurate operation and release of the phototriac coupler.

Item	Symbol	Value	Unit
Input LED current	$I_F$	20	mA

### \*Turn on time

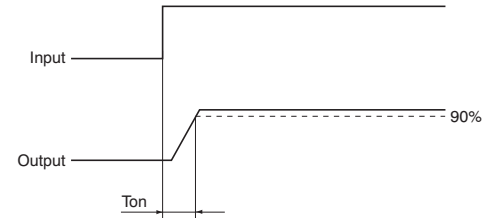

## REFERENCE DATA

1. ON-state RMS current vs. Ambient temperature characteristics  
Allowable ambient temperature:  
-30°C to +85°C -22°F to +185°F

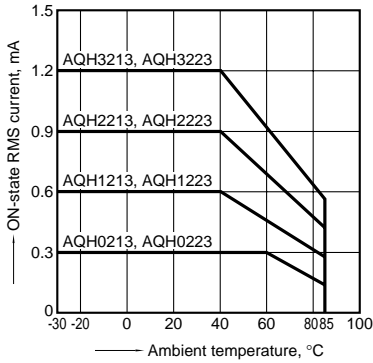

2. On voltage vs. Ambient temperature characteristics  
LED current: 10 mA; ON current: Max.  
Measured portion: between terminals 6 and 8

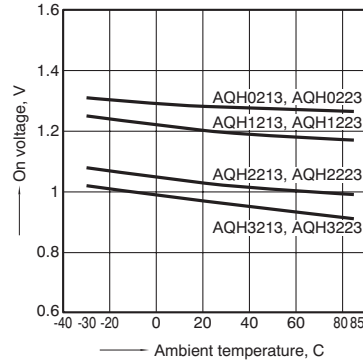

3. Trigger LED current vs. Ambient temperature characteristics  
Load voltage: 6 V DC;  
Load resistance: 100 $\Omega$

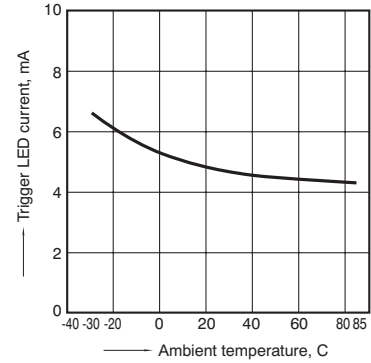

4. LED dropout voltage vs. Ambient temperature characteristics  
LED current: 10 to 50 mA

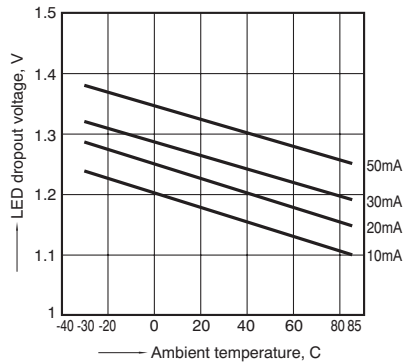

5. Turn on time vs. LED current characteristics  
Load voltage: 6 V DC; Load resistance: 100 $\Omega$   
Measured portion: between terminals 6 and 8

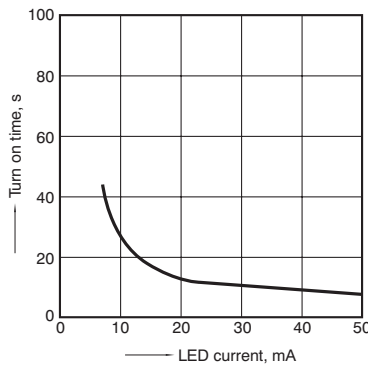

6. Repetitive peak OFF-state current vs. Load voltage characteristics  
LED current: 0 mA; Measured portion: between terminals 6 and 8; Ambient temperature: 25°C 77°F

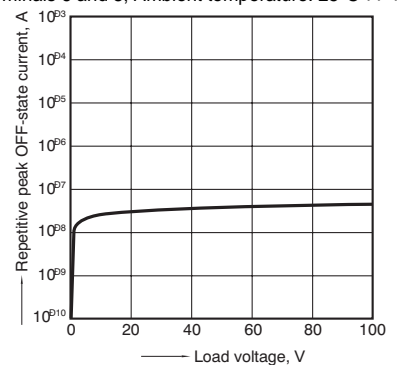

7. Hold current vs. Ambient temperature characteristics

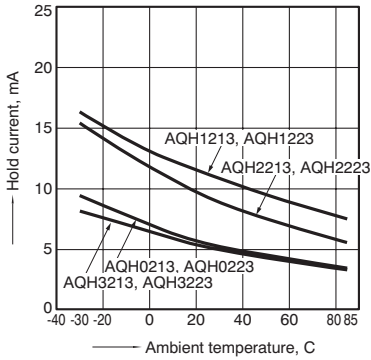

8. Zero-cross voltage vs. Ambient temperature characteristics  
LED current: 10 mA

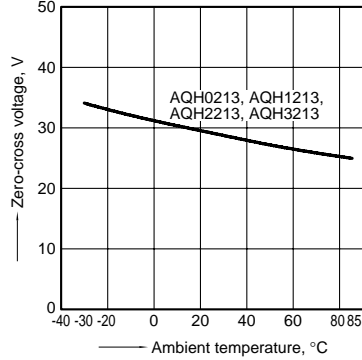

**DIMENSIONS** (mm inch)

Through hole terminal type

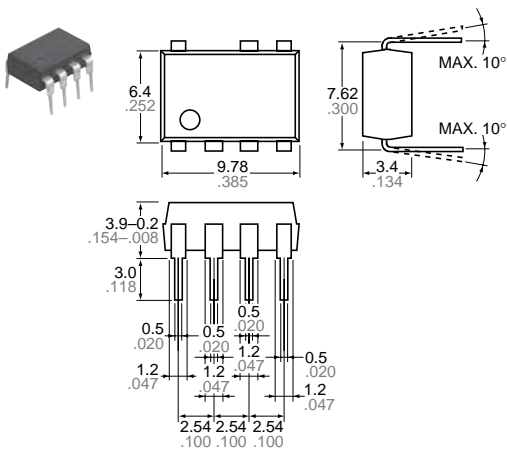

Terminal thickness: 0.25 .010  
General tolerance:  $\pm 0.1 \pm .004$

Surface mount terminal type

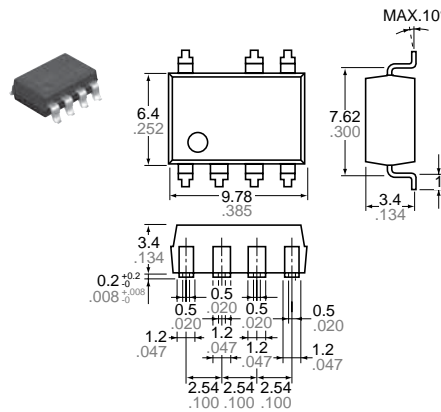

Terminal thickness: 0.25 .010  
General tolerance:  $\pm 0.1 \pm .004$

PC board pattern  
(BOTTOM VIEW)

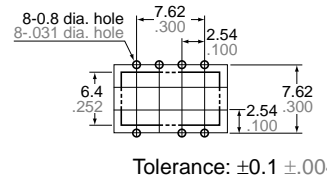

Tolerance:  $\pm 0.1 \pm .004$

Recommended mounting pad  
(TOP VIEW)

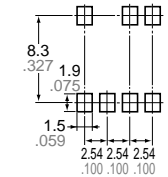

Tolerance:  $\pm 0.1 \pm .004$

**SCHEMATIC AND WIRING DIAGRAMS**

Notes: E<sub>1</sub>: Power source at input side; I<sub>F</sub>: Trigger LED forward current; V<sub>L</sub>: Load voltage; I<sub>L</sub>: Load current;

Schematic	Output configuration	Load	Wiring diagram
	1a	AC	

See special section on AQ-H in Cautions for Use