

FEATURES

1. Slim and low profile design (Pitch: 0.2 mm)

0.2 mm pitch back lock design and the slim body with a 3.15 mm depth (with the lever).



Unit: mm

2. Mechanical design freedom is achieved with double top and bottom contacts

Top and bottom double contacts eliminate the need of using different connectors (with either top or bottom contacts) depending on the FPC wiring conditions.

- 3. Easy-to-handle back lock design
- 4. Man-hours of assembly time can be reduced by delivering the connectors with their levers opened.
- 5. Wiring patterns can be placed underneath the connector.
- 6. Ni barrier helps resist solder creepage.

APPLICATIONS

Mobile devices, such as cellular phones, smartphones, digital still cameras and digital video cameras.

ORDERING INFORMATION

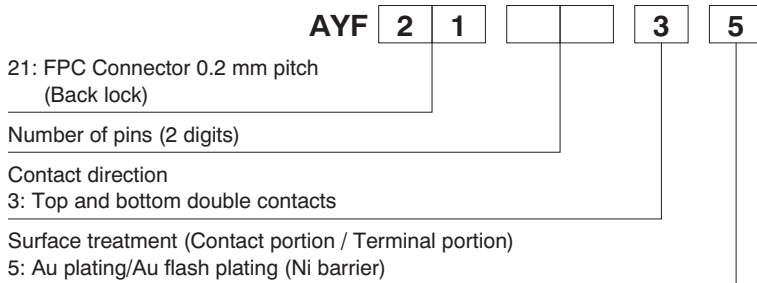

PRODUCT TYPES

Height	Number of pins	Part number	Packing	
			Inner carton	Outer carton
0.9 mm	23	AYF212335	5,000 pieces	10,000 pieces
	31	AYF213135		
	41	AYF214135		
	51	AYF215135		

Notes: 1. Order unit;

For volume production: 1-inner carton (1-reel) units

Samples for mounting check: 50-connector units. Please contact our sales office.

2. Please contact our sales office for connectors having a number of pins other than those listed above.

SPECIFICATIONS

1. Characteristics

	Item	Specifications	Conditions																		
Electrical characteristics	Rated current	0.2A/pin contact (Max. 5A at total pin contacts)																			
	Rated voltage	50V AC/DC																			
	Insulation resistance	Min. 1,000M Ω (initial)	Using 250V DC megger (applied for 1 min.)																		
	Breakdown voltage	150V AC for 1 min.	No short-circuiting or damage at a detection current of 1 mA when the specified voltage is applied for one minute.																		
	Contact resistance	Max. 100m Ω	Based on the contact resistance measurement method specified by JIS C 5402.																		
Mechanical characteristics	FPC holding force	Min. 0.13N/pin contacts \times pin contacts (initial)	Measurement of the maximum force applied until the inserted compatible FPC is pulled out in the insertion axis direction while the connector lever is closed																		
Environmental characteristics	Ambient temperature	-55°C to +85°C	No freezing at low temperatures. No dew condensation.																		
	Storage temperature	-55°C to +85°C (product only) -40°C to +50°C (emboss packing)																			
	Thermal shock resistance (with FPC inserted)	5 cycles, insulation resistance min. 100M Ω , contact resistance max. 100m Ω	Conformed to MIL-STD-202F, method 107G <table border="1"> <thead> <tr> <th>Order</th> <th>Temperature (°C)</th> <th>Time (minutes)</th> </tr> </thead> <tbody> <tr> <td>1</td> <td>-55$\frac{0}{3}$</td> <td>30</td> </tr> <tr> <td>2</td> <td>}</td> <td>Max. 5</td> </tr> <tr> <td>3</td> <td>85$\frac{0}{3}$</td> <td>30</td> </tr> <tr> <td>4</td> <td>}</td> <td>Max. 5</td> </tr> <tr> <td></td> <td>-55$\frac{0}{3}$</td> <td></td> </tr> </tbody> </table>	Order	Temperature (°C)	Time (minutes)	1	-55 $\frac{0}{3}$	30	2	}	Max. 5	3	85 $\frac{0}{3}$	30	4	}	Max. 5		-55 $\frac{0}{3}$	
	Order	Temperature (°C)	Time (minutes)																		
	1	-55 $\frac{0}{3}$	30																		
	2	}	Max. 5																		
	3	85 $\frac{0}{3}$	30																		
4	}	Max. 5																			
	-55 $\frac{0}{3}$																				
Humidity resistance (with FPC inserted)	120 hours, insulation resistance min. 100M Ω , contact resistance max. 100m Ω	Bath temperature 40 \pm 2°C, humidity 90 to 95% R.H.																			
Saltwater spray resistance (with FPC inserted)	24 hours, insulation resistance min. 100M Ω , contact resistance max. 100m Ω	Bath temperature 35 \pm 2°C, saltwater concentration 5 \pm 1%																			
H ₂ S resistance (with FPC inserted)	48 hours, contact resistance max. 100m Ω	Bath temperature 40 \pm 2°C, gas concentration 3 \pm 1 ppm, humidity 75 to 80% R.H.																			
Soldering heat resistance	Peak temperature: 260°C or less 300°C within 5 sec. 350°C within 3 sec.	Reflow soldering Soldering iron																			
Lifetime characteristics	Insertion and removal life	20 times	Repeated insertion and removal: min. 10 sec./time																		
Unit weight		51 pin contact type: 0.07 g																			

2. Material and surface treatment

Part name	Material	Surface treatment
Molded portion	Housing: LCP resin (UL94V-0) Lever: LCP resin (UL94V-0)	—
Contact	Copper alloy	Contact portion; Base: Ni plating, Surface: Au plating Terminal portion; Base: Ni plating, Surface: Au plating

DIMENSIONS (Unit: mm)

Interested in CAD data? You can obtain CAD data for all products with a **CAD Data** mark from your local Panasonic Electric Works representative.

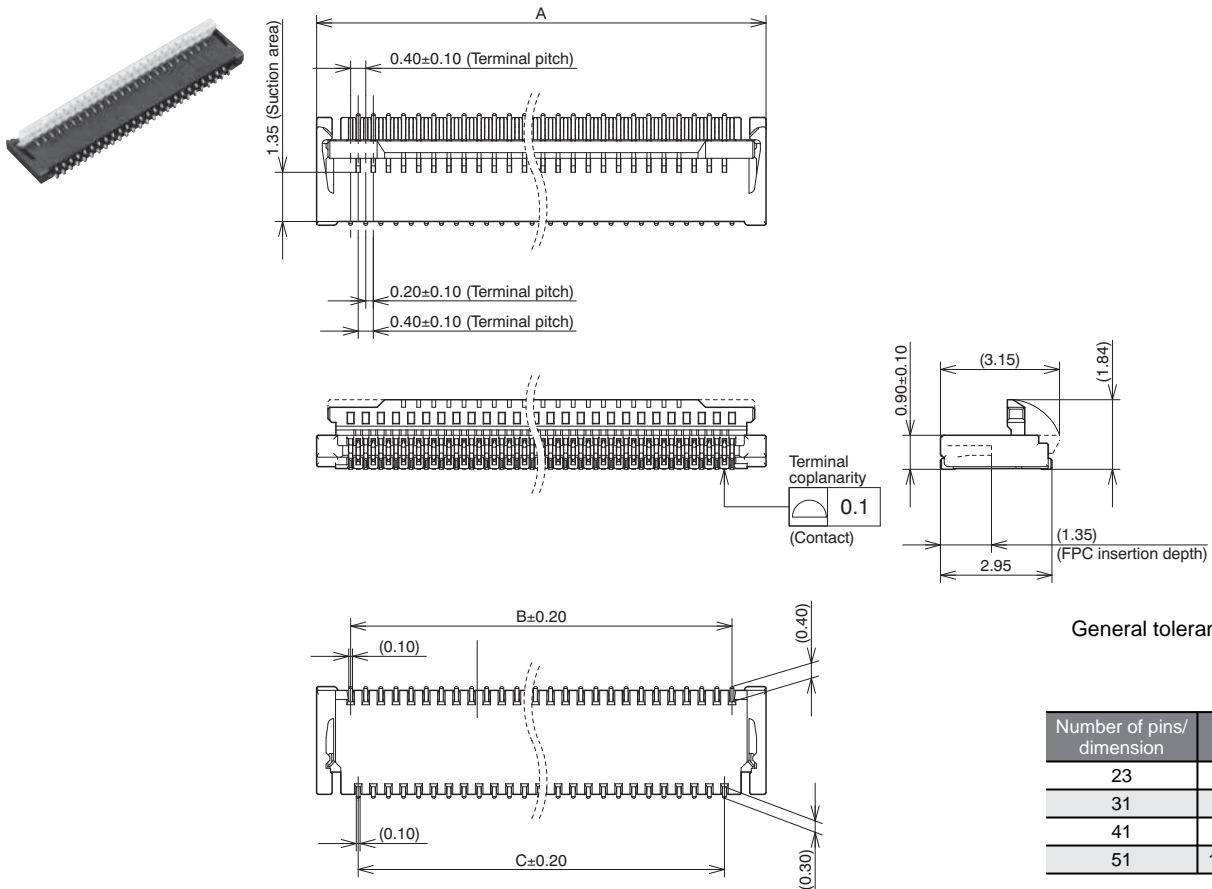

Number of pins/ dimension	A	B	C
23	6.20	4.40	4.00
31	7.80	6.00	5.60
41	9.80	8.00	7.60
51	11.80	10.00	9.60

RECOMMENDED FPC DIMENSIONS

(Finished thickness: $t = 0.2 \pm 0.03$)
The conductive parts should be based by Ni plating and then Au plating.

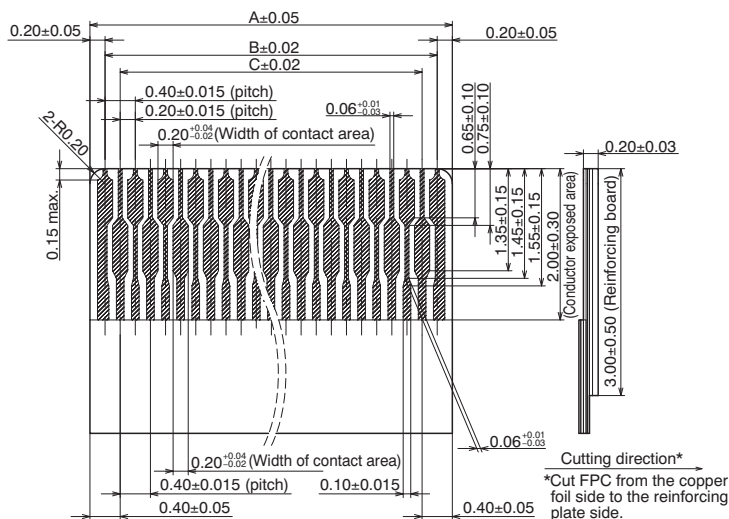

Number of pins/ dimension	A	B	C
23	4.80	4.40	4.00
31	6.40	6.00	5.60
41	8.40	8.00	7.60
51	10.40	10.00	9.60

EMBOSSED TAPE DIMENSIONS (Unit: mm) (Common for respective contact type)

• Specifications for taping

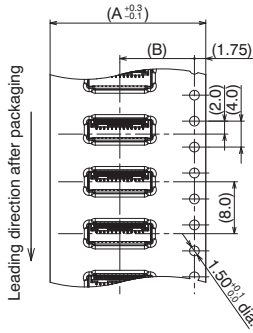

• Specifications for the plastic reel
(In accordance with EIAJ ET-7200B.)

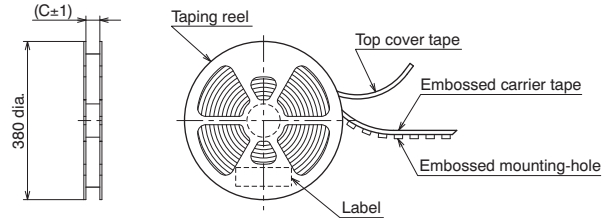

• Dimension table (Unit: mm)

Number of pins	A	B	C	Quantity per reel
23	16.0	7.5	17.4	5,000
31, 41, 51	24.0	11.5	25.4	5,000

• Connector orientation with respect to embossed tape feeding direction

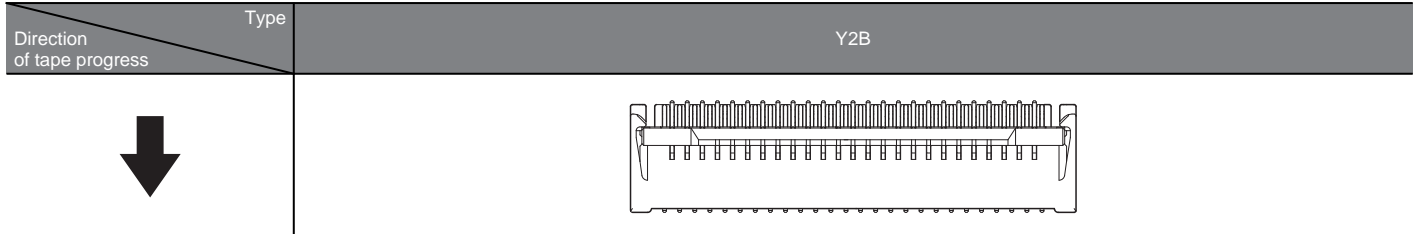

NOTES

1. Recommended PC board and metal mask patterns

Connectors are mounted with high pitch density, intervals of 0.2 mm or 0.3 mm. In order to reduce solder bridges and other issues make sure the proper levels of solder is used.

The figures to the right are recommended metal mask patterns. Please use them as a reference.

Recommended PC board pattern
(mounting layout)
(TOP VIEW)

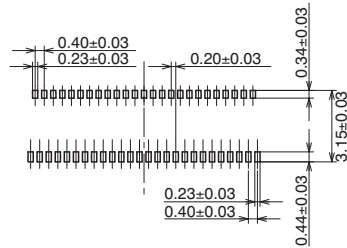

Recommended metal mask pattern

Metal mask thickness: Here, 120μm
(Front terminal portion opening area ratio: 96%)
(Back terminal portion opening area ratio: 96%)

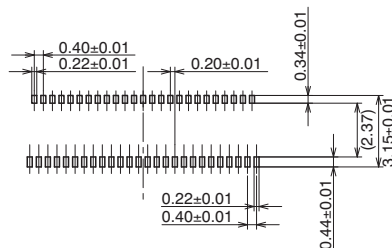

2. Precautions for insertion/removal of FPC

Avoid touching the lever (applying any external force) until an FPC is inserted. Do not open/close the lever without an FPC inserted. Failure to follow this instruction will cause the contacts to warp, leading to the contact tips to interfere with the insertion of an FPC, deforming the terminals. Failure to follow this instruction may cause the lever to be removed, terminals to be deformed, and/or the FPC insertion force to increase.

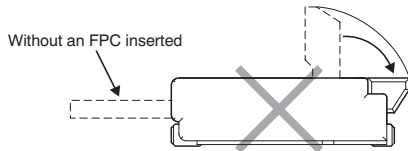

These connectors are of the back lock type, which has the FPC insertion section on the opposite side of the lever. Be careful not to make a mistake in the FPC insertion position or the lever opening/closing position. Otherwise, a contact failure or connector breakage may occur. These connectors have top and bottom double contacts. Do not insert an FPC upside down. Inserting an FPC in a direction opposite to that you intended may cause an operation failure or malfunction.

Insert an FPC with the lever opened at right angle, that is, in the factory default position.

Completely insert the FPC horizontally. An FPC inserted at an excessive angle to the board may cause the deformation of metal parts, FPC insertion failures, and FPC circuit breakages.

Insert the FPC to the full depth of the connector without altering the angle. Do not apply an excessive load to the lever in the opening direction beyond its open position; otherwise, the lever may be deformed or removed.

Do not apply an excessive load to the lever in a direction perpendicular to the lever rotation axis or in the lever opening direction; otherwise, the terminals may be deformed, and the lever may be removed.

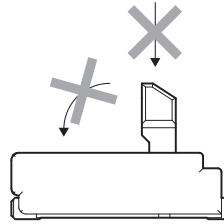

To close the lever, turn down the lever by pressing the entire lever or both sides of the lever with fingers tips.

If pressure to the lever is applied unevenly, it may deform or break the FPC. Make sure that the lever is closed completely. Not doing so will cause a faulty connection.

Avoid applying an excessive load to the top of the lever during or after closing the lever. Otherwise, the terminals may be deformed.

When opening the lever to remove the FPC, ensure that the lever will not go over the initial position; otherwise, the lever may be removed.

Remove the FPC at parallel with the lever fully opened. If the lever is closed, or if the FPC is forcedly pulled, the product or FPC may break.

If a lever is accidentally detached during the handling of a connector, do not use the connector any longer.

After an FPC is inserted, carefully handle it so as not to apply excessive stress to the base of the FPC.

When using FPC in bent condition, please pay attention to precautions below;

otherwise, in some conditions it may cause conduction failure, connector

breakage, unlocking lever or FPC disconnection.

Design so that a load is not applied to connector directly by FPC bending. Avoid sharp FPC bending at the root of FPC insertion part.

Design so that a load is not applied to the part of FPC bending.

If there might be a load on FPC, please fix the FPC.

Please refer to the latest product specifications when designing your product.

For Cautions for Use, see the “GENERAL NOTES FOR USING FPC CONNECTORS” in the [Connector Technical Information](#). For other details, please verify with the product specification sheets.