

# Series 1500 .375" (9.52mm) Center-to-Center Spacing

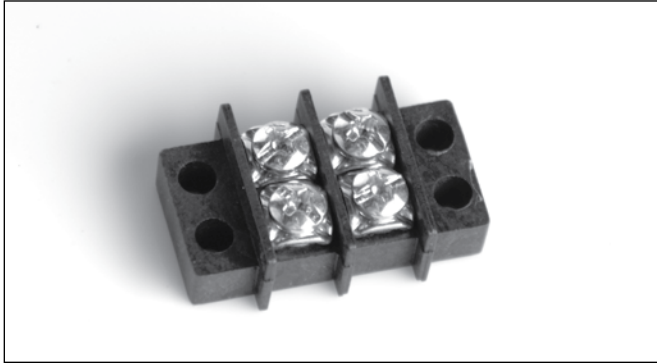

## Features:

- **Flexible Hi-Temp Thermoplastic Terminal Blocks** – Self-extinguishing types which resist breakage and other damage (conform to UL 94V-0).
- **Terminal Flexibility** – Ideal for surface mount, sub-panel or chassis connections in electronic/electrical circuit applications. One thru 22 terminals. 1500 Series is .375" on centers.
- **Economical Closed-Back Design** – No need for costly insulation strip.
- **Broad Wire Range** – No. 6-32 external twin screws, UL recognized for No. 22AWG to No. 10AWG. Variations include double solder lug, single solder lug, wire wrap, solder pin and printed circuit pin.
- **UL/CSA Electrical Ratings** – UL 30A/1100V RMS (1/3 breakdown voltage), CSA rating 15A/300V.
- **Recognition and Listing** – Various terminal types are UL recognized and CSA certified.

## Series 1500 Variations

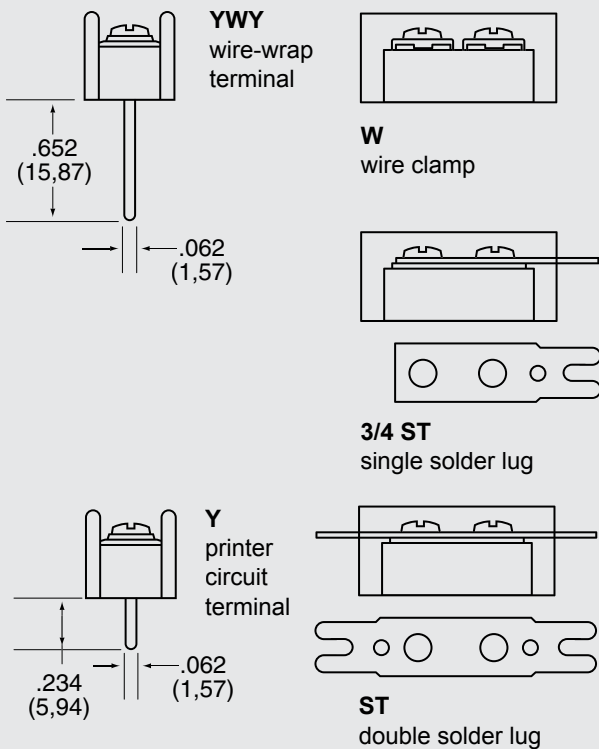

## INTERNAL TERMINAL DESIGNATIONS

- 1500-Y** printed circuit board design with .062" x .031" solderable tin-plated pin
- 1500-YWY** feed-thru wire wrap

## EXTERNAL TERMINAL DESIGNATIONS

- 1500** screw terminal with No. 6-32 plated steel\* screw accepting up to No. 10AWG wire
- 1500-ST** solderable tin-plated double solder tab
- 1500-3/4ST** solderable tin-plated single solder tab
- 1500-W** wire clamp captivated to a No. 6-32 plated steel screw

\* Other materials available – contact factory or your local representative for additional information.

**UL** Recognized under the Components Program of Underwriters Laboratories, Inc. Standard 1059, Guide No. XCFR2, File No. E62557.

**CSA** Guide No. 22.2 No. 158, Report No. LR39186-1. **COMPLIES WITH IEC 947-7-1**

## Series 1500 Dimensions

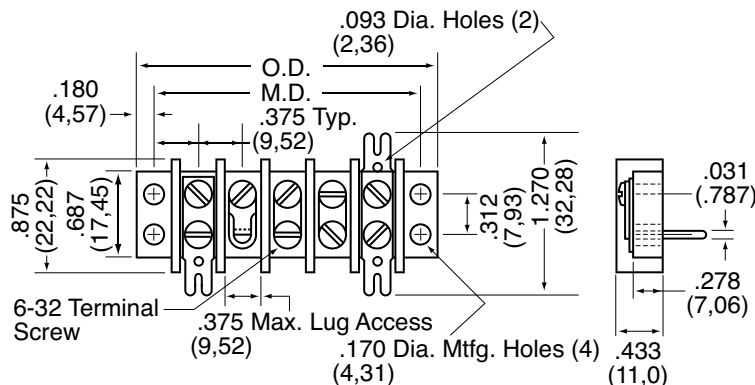

Dual Row

BARRIER STYLE



## Specifications:

**Center-to-Center Spacing:** .375" (9.52mm)

**Wire Range:** Up to No. 12AWG (CSA requires use of lugs on wire larger than No. 16AWG.)

**No. of Terminals:** 1 thru 22

### Voltage Rating:

CSA – 300V

UL – 150V – General Industrial

250V – Commercial Appliance

300V – Limited Energy Industrial

**Tightening Torque:** Wire Clamp and Wire Binding Screw 12 in.-lbs.

**Current Rating:** UL: 20 amps CSA: 15 amps

### Housing:

Material Polyphenylene Oxide

Continuous Use

Temp. (UL Index) 110°C (230°F)

Flammability Rating 94V-0

Water Absorption

(24 hrs. % wt. gain) .06%

Chemical Resistance Resistant to inorganic bases and acids. For organic substances contact factory for specific resistance.

### Breakdown Voltage:

Terminal - Terminal 3,400V Typ.

Terminal - Ground 7,300V Typ.

*Note:* Specifications contained herein are subject to change without notice.

## PC BOARD DRILLING DIMENSIONS

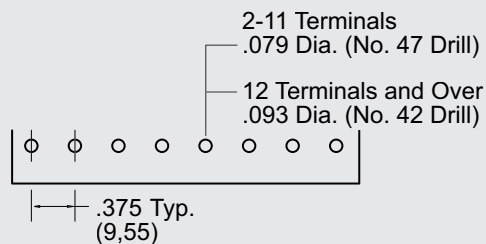

## How to Order

1500 Series terminal blocks are ordered by listing a composite number made up of the model designation in which the last two digits indicate the number of poles required for the application. Example: A 1500 10-terminal block (3/8" centers) becomes stock number 1510.

Suffixes are used as follows:

ST denotes double solder lug

3/4ST denotes single solder lug

Y denotes printed circuit pin

YWY feed-thru wire wrap

W wire clamp

The 1510 described above, with double solder lug mounting on 3/8" centers thus converts to stock number 1510-ST. To specify quick-connect terminals, simply add the style number required. (See accessories.) May be purchased factory-assembled or as customer-installed accessory.

| Number of Terminals | Mounting Dimensions |             | Overall Dimensions |             |
|---------------------|---------------------|-------------|--------------------|-------------|
|                     | Inches              | Metric (mm) | Inches             | Metric (mm) |
| 1                   | .750                | 19.05       | 1.030              | 26.16       |
| 2                   | 1.125               | 28.57       | 1.405              | 35.68       |
| 3                   | 1.500               | 38.10       | 1.780              | 45.21       |
| 4                   | 1.875               | 47.62       | 2.155              | 54.73       |
| 5                   | 2.250               | 57.15       | 2.530              | 64.26       |
| 6                   | 2.625               | 66.67       | 2.905              | 73.78       |
| 7                   | 3.000               | 76.20       | 3.280              | 83.31       |
| 8                   | 3.375               | 85.72       | 3.655              | 92.83       |
| 9                   | 3.750               | 95.25       | 4.030              | 102.36      |
| 10                  | 4.125               | 104.77      | 4.405              | 111.88      |
| 11                  | 4.500               | 114.30      | 4.780              | 121.41      |
| 12                  | 4.875               | 123.82      | 5.155              | 130.93      |
| 13                  | 5.250               | 133.35      | 5.530              | 140.46      |
| 14                  | 5.625               | 142.87      | 5.905              | 149.98      |
| 15                  | 6.000               | 152.40      | 6.280              | 159.51      |
| 16                  | 6.375               | 161.92      | 6.655              | 169.03      |
| 17                  | 6.750               | 171.45      | 7.030              | 178.56      |
| 18                  | 7.125               | 180.97      | 7.405              | 188.08      |
| 19                  | 7.500               | 190.05      | 7.780              | 197.61      |
| 20                  | 7.875               | 200.02      | 8.155              | 207.13      |
| 21                  | 8.250               | 209.55      | 8.530              | 216.66      |
| 22                  | 8.625               | 219.07      | 8.905              | 226.18      |

Dimensions Shown are ± 0.030"



# Series 2000 .4375" (11.1mm) Center-to-Center Spacing

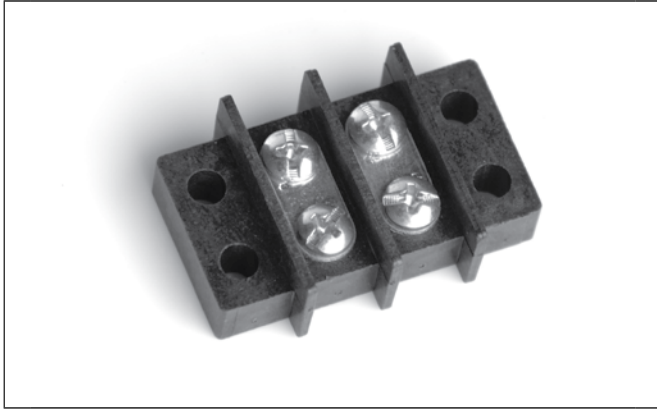

## Features:

- **Flexible Hi-Temp Thermoplastic Terminal Blocks** – Self-extinguishing types which resist breakage and other damage (conform to UL94V-0).
- **Terminal Flexibility** – Ideal for surface mount, sub-panel or chassis connections in electronic/electrical circuit applications. One thru 26 terminals.
- **Economical Closed-Back Design** – No need for costly insulation strip.
- **Broad Wire Range** – No. 6-32 external twin screws, UL recognized for No. 22AWG to No. 10AWG. Variations include double solder lug, single solder lug, wire wrap, solder pin and printed circuit pin.
- **UL/CSA Electrical Ratings** – UL 30A/1100V RMS (1/3 breakdown voltage), CSA rating: 20A/300.
- **Recognition and Listing** – Various terminal types are UL recognized and CSA certified.

## Series 2000 Variations

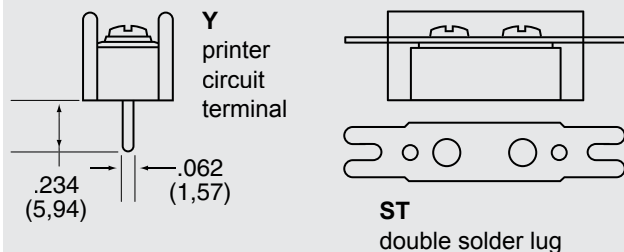
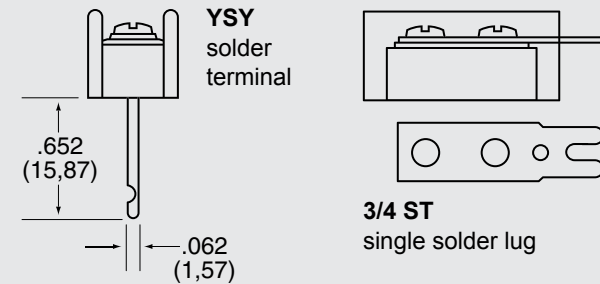
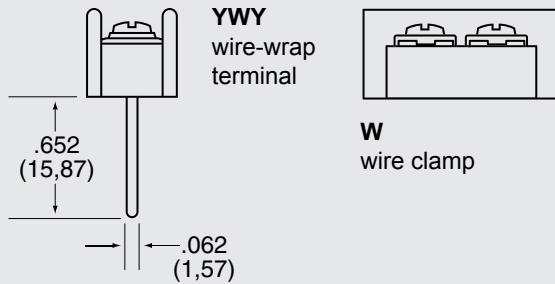

## INTERNAL TERMINAL DESIGNATIONS

|                 |   |
|-----------------|---|
| <b>2000-Y</b>   | printed circuit board design with .062" x .031" solderable tin-plated pin |
| <b>2000-YSY</b> | solder pin  |
| <b>2000-YWY</b> | wire wrap   |

## EXTERNAL TERMINAL DESIGNATIONS

|                   |   |
|-------------------|---|
| <b>2000</b>       | screw terminal with No. 6-32 plated steel* screw accepting up to No. 10AWG wire |
| <b>2000-ST</b>    | solderable tin-plated double solder tab   |
| <b>2000-3/4ST</b> | solderable tin-plated single solder tab   |
| <b>2000-W</b>     | wire clamp captivated to a No. 6-32 plated steel screw                          |

\* Other materials available – contact factory or your local representative for additional information.

 Recognized under the Components Program of Underwriters Laboratories, Inc. Standard 1059, Guide No. XCFR2, File No. E62557.

 Guide No. 22.2 No. 158, Report No. LR39186-1. COMPLIES WITH IEC 947-7-1

## Series 2000 Dimensions

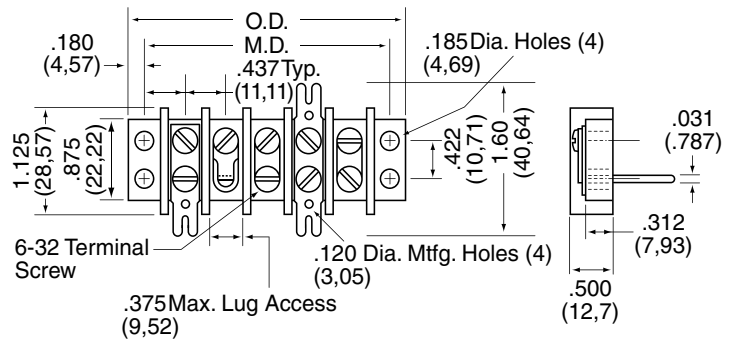

Dual Row

BARRIER STYLE



## Specifications:

**Center-to-Center Spacing:** .4375" (11.11mm)

**Wire Range:** Up to No. 10AWG (CSA requires use of lugs on wire larger than No. 16AWG.)

**No. of Terminals:** 1 thru 26

### Voltage Rating:

CSA – 300V

UL – 150V – General Industrial

250V – Commercial Appliance

300V – Limited Energy Industrial

**Tightening Torque:** Wire Clamp and Wire Binding Screw 12 in.-lbs.

**Current Rating:** UL: 30 amps CSA: 20 amps

### Housing:

Material Polyphenylene Oxide

Continuous Use

Temp. (UL Index) 110°C (230°F)

Flammability Rating 94V-0

Water Absorption

(24 hrs. % wt. gain) .06%

Chemical Resistance Resistant to inorganic bases and acids. For organic substances contact factory for specific resistance.

### Breakdown Voltage:

Terminal - Terminal 4,400V Typ.

Terminal - Ground 7,700V Typ.

*Note:* Specifications contained herein are subject to change without notice

## PC BOARD DRILLING DIMENSIONS

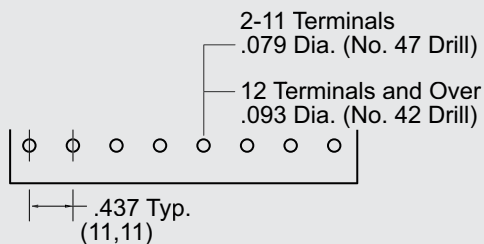

## How to Order

2000 Series terminal blocks are ordered by listing a composite number made up of the model designation in which the last two digits indicate the number of poles required for the application. Example: A 2000 10-terminal block becomes stock number 2010.

Suffixes are used as follows:

ST denotes double solder lug

3/4ST denotes single solder lug

Y denotes printed circuit pin

YSY solder pin

YWY wire wrap

W wire clamp

The 2010 described above, with double solder lug mounting on 7/16" centers thus converts to stock number 2010-ST. To specify quick-connect terminals, simply add the style number required. (See accessories.) May be purchased factory-assembled or as customer-installed accessory.

| Number of Terminals | Mounting Dimensions |             | Overall Dimensions |             |
|---------------------|---------------------|-------------|--------------------|-------------|
|                     | Inches              | Metric (mm) | Inches             | Metric (mm) |
| 1                   | .875                | 22.22       | 1.235              | 31.36       |
| 2                   | 1.312               | 33.33       | 1.672              | 42.48       |
| 3                   | 1.750               | 44.45       | 2.110              | 53.59       |
| 4                   | 2.187               | 55.56       | 2.547              | 64.70       |
| 5                   | 2.625               | 66.67       | 2.985              | 75.81       |
| 6                   | 3.062               | 77.78       | 3.422              | 86.93       |
| 7                   | 3.500               | 88.90       | 3.860              | 98.04       |
| 8                   | 3.937               | 100.01      | 4.297              | 109.15      |
| 9                   | 4.375               | 111.12      | 4.735              | 120.26      |
| 10                  | 4.812               | 122.23      | 5.172              | 131.38      |
| 11                  | 5.250               | 133.35      | 5.610              | 142.49      |
| 12                  | 5.687               | 144.46      | 6.047              | 153.60      |
| 13                  | 6.125               | 155.57      | 6.485              | 164.71      |
| 14                  | 6.562               | 166.68      | 6.922              | 175.83      |
| 15                  | 7.000               | 177.80      | 7.360              | 186.94      |
| 16                  | 7.437               | 188.91      | 7.797              | 198.05      |
| 17                  | 7.875               | 200.02      | 8.235              | 209.16      |
| 18                  | 8.312               | 211.13      | 8.672              | 220.28      |
| 19                  | 8.750               | 222.25      | 9.110              | 231.39      |
| 20                  | 9.187               | 233.36      | 9.547              | 242.50      |
| 21                  | 9.625               | 244.47      | 9.985              | 253.61      |
| 22                  | 10.062              | 255.58      | 10.422             | 264.73      |
| 23                  | 10.500              | 266.70      | 10.860             | 275.84      |
| 24                  | 10.938              | 277.83      | 11.299             | 286.77      |
| 25                  | 11.376              | 288.95      | 11.736             | 298.09      |
| 26                  | 11.814              | 300.08      | 12.174             | 309.22      |

Dimensions Shown are  $\pm 0.030$ "



## Series 1500/2000 Accessories

### QUICK-CONNECT TERMINALS

1500/2000 – Available with .187" x .202" quick-connect tabs for 1500 series; .250" x .032" for 2000 series. Nine styles . . . tin-plated brass tabs held in place by terminal screws. Up to six terminations per pole. To order, specify:

1500 Series: Part No. TB11-19

2000 Series: Part No. TB31-39

Last digit of part number corresponds to previous style numbers.

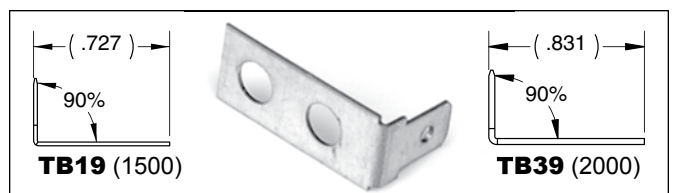
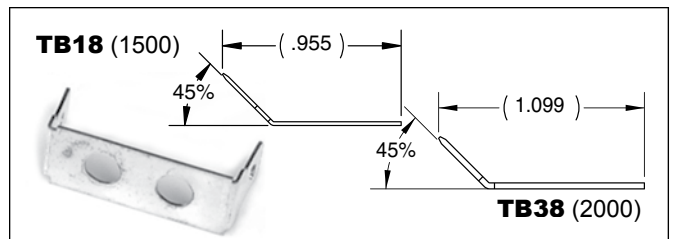
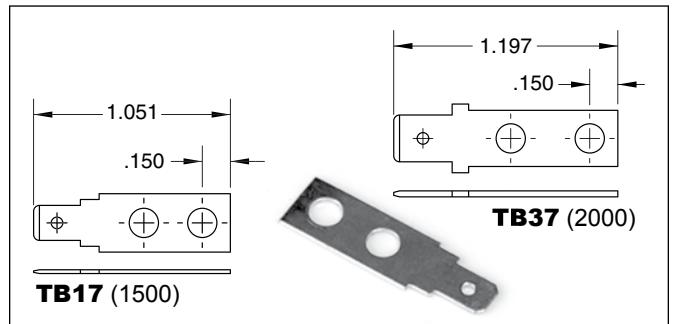
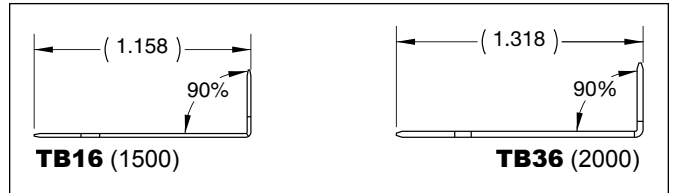
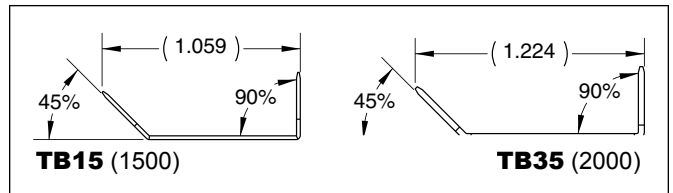
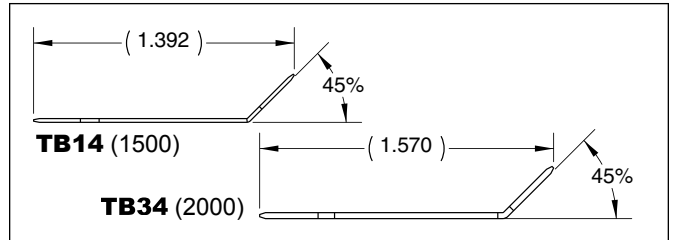
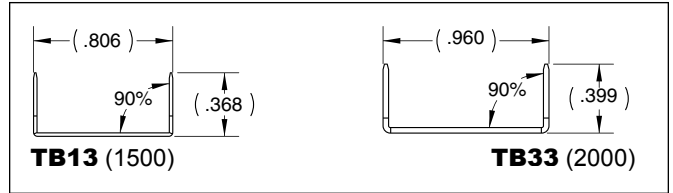
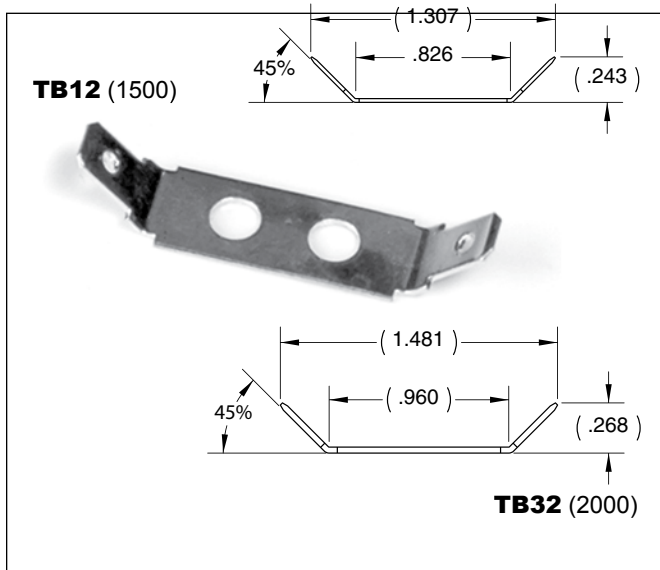
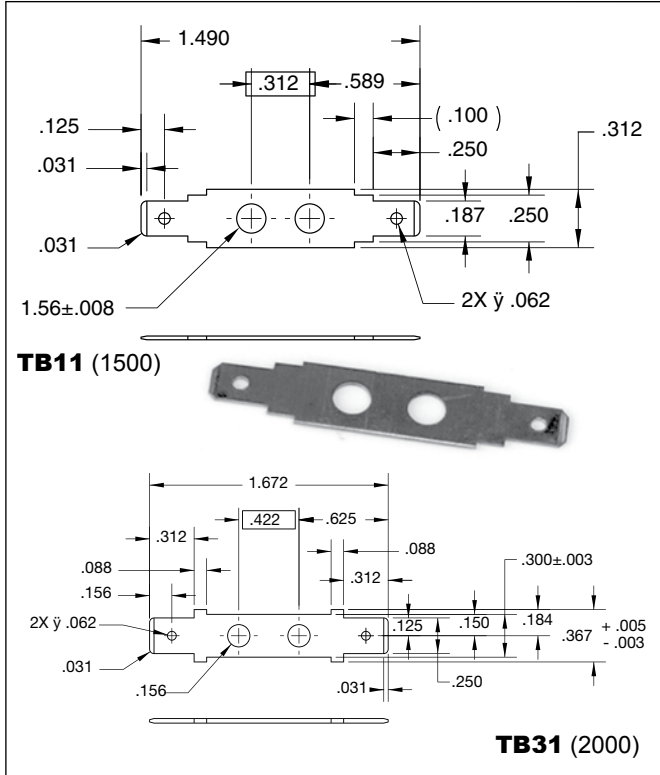

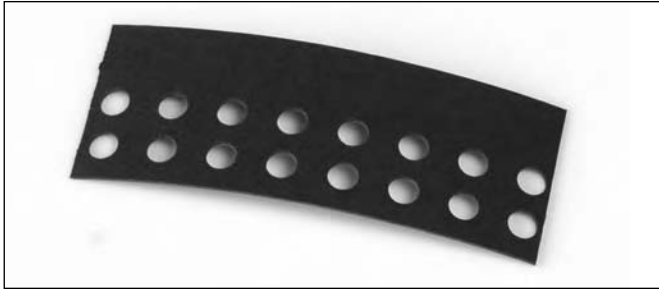

### MARKING STRIPS

1500/2000 Pre-punched black fiber . . . mounts under block.  
May be imprinted to customer specifications.

To order, specify:

1500 Series – Part No. 247A10-1 thru 22

2000 Series – Part No. 247A11-1 thru 22

### WIRE CLAMP

1500/2000 – Wire clamp captivated to No. 6-32 screw eliminates need for lugs.

1500 Series – Part No. 058525700

2000 Series – Part No. 058526700

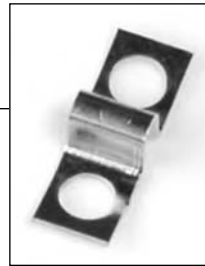
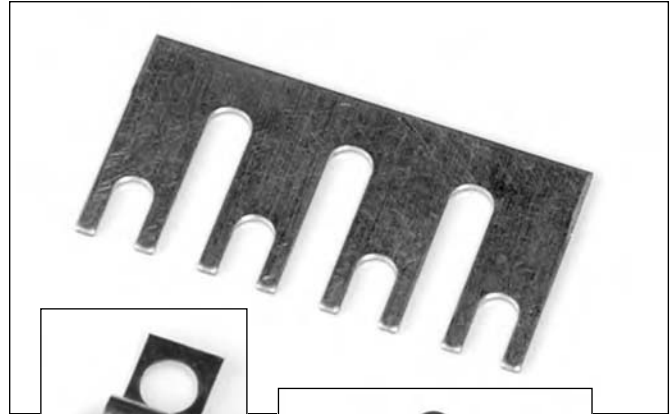

Part No.  
68240100



Part No. 68245100

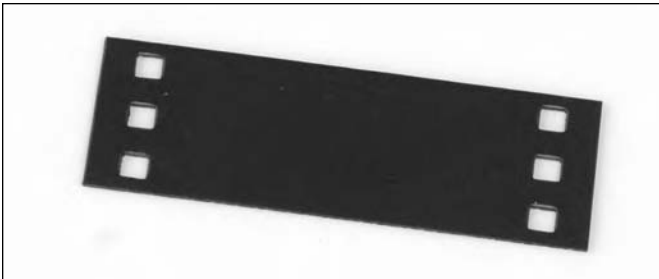

### COVERS

1500/2000 – Rigid .030" thick self-extinguishing vinyl.  
Complete with spring clips for attaching to mounting positions.

To order, specify:

1500 Series – Part No. 247B24-1 thru 26 terminals

2000 Series – Part No. 247B25-1 thru 26 terminals

### TERMINAL BLOCK JUMPERS

1500 – Jumper is constructed of plated brass. "Rooster comb" design permits connections of two to 10 poles.

To order, specify: Part No. 278-A11 (plus no. of poles)

*Example: 278A11-10*

Part No. 68240100 (Holes) or 68245100 (slots)  
(2-pole jumper for 1500 only)

2000 – Plated brass in two styles. Types 278A28 is designed to jump two adjacent terminals as it is channeled to cross over the barrier top. "Rooster comb" design of Type 267A42 permits connections of two to 18 poles.

To order, specify: Part No. 267A42 (plus no. of poles)

*Example: 267A42-18*

