

## Thumbwheel Switch

A7

### A Wide Selection of Models: Thumbwheel- or Push-operated, Decimal or Hexadecimal

- A wide selection ranging from miniature models that save space to large models with enhanced readability and operability.
- Select models with the specifications desired, or where long life and reliability are critical.
- Additional new models prevent value changes due to accidental pressing of buttons. Pen-push or locking types are available.

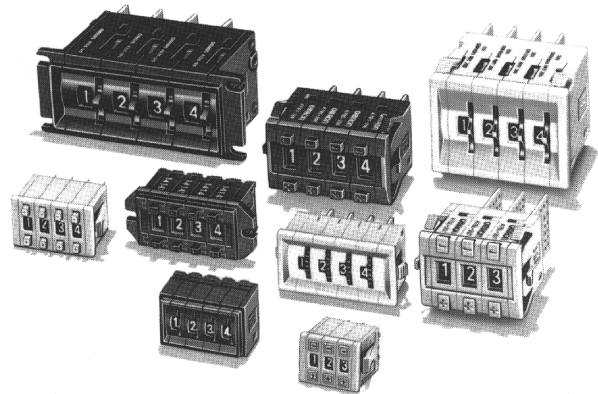

## Ordering Information

### ■ Push-operated Switches

Model and mounting	Terminals	Color	Output code					
			03 (decimal code)	06 (binary coded decimal)	07 (binary coded decimal with component adding provision)	19 (decimal code with component adding provision)	54 (binary coded hexadecimal)	55 (binary coded hexadecimal with component adding provision)
A7DP-2 (pen-push) Snap-in	PCB terminal	Light gray	---	A7DP-206	---	---	---	---
		Black	---	A7DP-206-1	---	---	---	---
A7D-2 Snap-in	PCB terminal	Light gray	---	A7D-206	---	---	---	---
		Black	---	A7D-206-1	---	---	---	---
A7D-1 Screw mounting	PCB terminal	Light gray	---	A7D-106	---	---	---	---
		Black	---	A7D-106-1	---	---	---	---
A7CN Screw mounting	PCB terminal	Light gray	---	---	---	---	---	---
		Black	---	A7CN-106-1	---	---	---	---
A7CN Snap-in	PCB terminal	Light gray	---	A7CN-206	---	---	---	---
		Black	---	A7CN-206-1	---	---	---	---
A7CNL (Locking) Snap-in	PCB terminal	Light gray	---	A7CN-L206	---	---	---	---
		Black	---	A7CN-L206-1	---	---	---	---
A7BL (locking) Snap-in	Solder terminal (see note 1)	Light gray	---	A7BL-206	A7BL-207	---	---	---
		Black	---	A7BL-206-1	A7BL-207-1	---	---	---
A7BS Snap-in	Solder terminal (see note 1)	Light gray	(A7BS-203)	A7BS-206	A7BS-207	(A7BS-219)	A7BS-254	A7BS-255
		Black	(A7BS-203-1)	A7BS-206-1	A7BS-207-1	(A7BS-219-1)	A7BS-254-1	A7BS-255-1

Model and mounting	Terminals	Color	Output code					
			03 (decimal code)	06 (binary coded decimal)	07 (binary coded decimal with component adding provision)	19 (decimal code with component adding provision)	54 (binary coded hexadecimal)	55 (binary coded hexadecimal with component adding provision)
A7BS-20□-S (with external Stoppers) Snap-in	Solder terminal (see note 1)	Light gray	---	A7BS-206-S	A7BS-207-S	---	---	---
		Black	---	A7BS-206-S-1	A7BS-207-S-1	---	---	---
A7PS Snap-in	Solder terminal (see note 1)	Light gray	A7PS-203	A7PS-206	A7PS-207	A7PS-219	A7PS-254	A7PS-255
		Black	A7PS-203-1	A7PS-206-1	A7PS-207-1	A7PS-219-1	A7PS-254-1	A7PS-255-1
A7PH (long life) Snap-in	Solder terminal (see note 1)	Light gray	A7PH-203	A7PH-206	A7PH-207	A7PH-219	---	---
		Black	A7PH-203-1	A7PH-206-1	A7PH-207-1	A7PH-219-1	---	---

- Note:** 1. Terminals for use with PCBs are also available. Inquire for details.  
2. Please inquire about Code 01 models with +, - displays (-PM) and models in parentheses.

### Accessories (Order Separately)

Applicable Switch Unit	Color	End Caps	Spacers (see note 1)	Connectors	
				Solder terminals	PCB terminals
A7D-1	Light gray	A7D-1M	A7D-1PA	---	---
	Black	A7D-1M-1	A7D-1PA-1	---	---
A7DP-2/A7D-2	Light gray	A7D-2M	A7D-2PA	---	---
	Black	A7D-2M-1	A7D-2PA-1	---	---
A7CN Screw mounting	Light gray	---	---	---	---
	Black	A7CN-1M-1	A7CN-1P□-1	---	---
A7CN/A7CN-L Snap-in	Light gray	A7CN-2M	A7CN-2P□	---	---
	Black	A7CN-2M-1	A7CN-2P□-1	---	---
A7BL/A7BS/A7BS-20□-S (see note 2)	Light gray	A7B-M	A7B-PA	A7B-C	A7B-CP
	Black	A7B-M-1	A7B-PA-1	---	---
A7PS	Light gray	A7P-M	A7P-PA	---	---
	Black	A7P-M-1	A7P-PA-1	---	---
A7PH	Light gray	A7P-M	A7P-PA	---	---
	Black	A7P-M-1	A7P-PA-1	---	---

- Note:** 1. Spacers come standard without characters. Refer to page 30 for characters to be included.  
2. Stopper pin comes standard.  
Model: A7BS-S  
(Stopper pins come in pairs. They are shipped free initially. Please make special arrangements for maintenance.)

## ■ Thumbwheel Switches

onlinecomponents.com  
THE ONLINE DISTRIBUTOR OF ELECTRONIC COMPONENTS

Models and mounting	Terminals	Color	Output code			
			01 (binary code with +, - displayed)	03 (decimal code)	06 (binary coded decimal)	07 (binary coded decimal with component adding provision)
A7MD/ A7MD-□□-D (see note 1) Fastens to panel via printed circuit board.	PCB terminal	Black	---	---	A7MD-106-P-09	---
			---	---	A7MD-106-P-09-D (see note 1)	---
A7MA-1 Screw mounting	Solder terminal	Black	(A7MA-106-PM)	(A7MA-103)	A7MA-106	A7MA-107
	PCB terminal		(A7MA-P2-PM)		A7MA-106-P2	A7MA-107-P2
A7MA-2 Snap-in	Solder terminal	Light gray	(A7MA-206-PM)	---	A7MA-206	A7MA-207
		Black	(A7MA-206-PM-1)		A7MA-206-1	A7MA-207-1
	PCB terminal	Light gray	(A7MA-206-P2-PM)		A7MA-206-P2	A7MA-207-P2
		Black	(A7MA-206-P2- PM-1)		A7MA-206-P2-1	A7MA-207-P2-1
A7SS Screw mounting	Solder terminal	Black	(A7SS-106-PM)	A7SS-103	A7SS-106	A7SS-107
A7AS Snap-in	Solder terminal	Light gray	(A7AS-206-PM)	A7AS-203	A7AS-206	A7AS-207
		Black	(A7AS-206-PM-1)	A7AS-203-1	A7AS-206-1	A7AS-207-1

- Note:** 1. Indicates models with built-in diodes.  
2. Please inquire about models in parentheses.

Model and mounting	Terminals	Color	Output code					
			08 (06 + 22)	13 (double-side d PCB version of 06)	14 (06 with odd parity)	19 (decimal code with component adding provision)	22 (06 with complement ary code)	36 (double-side d PCB version of 07)
A7SS Screw mounting	Solder terminal	Black	---	---	---	A7SS-119	---	---
A7AS Snap-in	Solder terminal	Light gray	---	---	---	A7AS-219	(A7AS-222)	---
		Black	---	---	---	A7AS-219-1	(A7AS-222-1)	---

- Note:** Inquire about models in parentheses.

### Accessories (Order Separately)

Applicable Switch Unit	Color	End Caps (left-right set)	Spacers (see note 2)	Connectors	
				Solder terminal	PCB terminal
A7MD(-D)	Black	A7MD-1M	A7MD-PA	---	---
A7MA-1	Black	A7M-1M	A7M-1PA	---	---
A7MA-2	Light gray	A7M-2M	A7M-2PA	---	---
	Black	A7M-2M-1	A7M-2PA-1	---	---
A7SS	Black	A7SS-M	---	---	---
A7AS	Light gray	A7AS-M	---	---	---
	Black	A7AS-M-1	---	---	---

- Note:** 1. Spacers serve the same purpose as spare Switch Units, except that their widths differ. Refer to page 30, *Dimensions*, for further information.  
2. Spacers come standard without characters. Refer to page 30 for characters to be included.

## ■ Ordering Procedure

### Configurations

The Thumbwheel Switch is generally used in the configuration shown below.

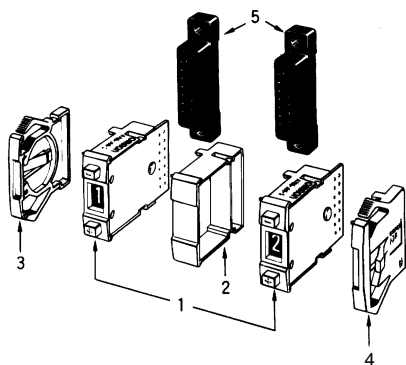

- 1: Switch Unit refers to the Switch itself. As each digit is independent of the others, a number of Switch Units are assembled to make up just the number of digits needed.
- 2: Spacers can be used in case the number of digits change due to a change in specifications. When units for time and length must be displayed, the necessary letters and symbols can be printed or stamped. The stamping shown in the following table can be produced. Inquire for details.

### Stamping

<b>Symbol</b>	A	B	C	D	E	F	G
<b>Stamp</b>	No designation	SEC	MIN	H	g	kg	mm
<b>Symbol</b>	H	J	K	L	Q	T	U
<b>Stamp</b>	cm	m	°C	PCS	x 10 SEC	0	•

- 3, 4: End Caps/Side Plates: These are used at both ends of the Switch Unit to insure a solid mount of each Switch Unit to a panel. Left and right plates make a set.
- 5: Connectors: Since the Switch Unit snaps right into a Connector, accomplishing both attachment and wiring in a single action, connections, maintenance and inspection are greatly simplified.

onlinecomponents.com

THE ONLINE DISTRIBUTOR OF ELECTRONIC COMPONENTS

### Ordering

Standard products such as the Switch Units and End Caps are not factory-assembled for shipment. Place orders as shown below, specifying the model and number of Switch Units.

Ordering Example:

Figure	Product name	Model	Number of Units
1	Switch Unit	A7BS-206-1	2
2	Spare Unit	A7B-PA-1	1
3	Attachment Board	A7B-M-1	1 set
4			
5	Connector	A7B-CP	2

### Special Characters and Symbols for Dial Displays

Dials can be ordered with special characters or symbols as well as with Stoppers attached. Ask your OMRON sales representatives.

### Positive, Negative Dials

To order dials marked with +, -, +, -, ... in place of the numerals 0 to 9, add the suffix -PM to the model number. (Refer to page 18 for details)

Example: A7PS-203-PM

### Attaching Stoppers

Stoppers are used to limit the display range from 0 to 9 down to 0 to 5, for example.

Add -S□□ to the suffix, specifying the range in the blanks.

Example: A7PS-203-S05

Units to which Stoppers can be attached are the A7DP, A7D, A7BL, A7PS, A7PH, A7SS, and A7AS.

On the outside of the A7BS-□-S is a Stopper Pin with which the user can make any setting.

The A7CN-2, A7CN-1, A7CN-L, A7MD, and A7MA cannot be equipped with Stoppers.

# Specifications

onlinecomponents.com  
THE ONLINE DISTRIBUTOR OF ELECTRONIC COMPONENTS

## ■ Ratings/Characteristics

### Push-operated Switches

Item		A7DP-2/A7D-1 /A7D-2	A7CN/A7CN-L	A7BL/A7BS /A7BS-20□-S	A7PS	A7PH
<b>Switching capacity (resistive load)</b>		5 to 30 VDC 1 mA to 0.1 A	5 to 28 VDC 1 mA to 0.1 A		125 VAC/28 VDC 10 μA to 0.15 A	
<b>Continuous carry current</b>		100 mA	1 A max.		3 A max.	
<b>Contact resistance</b>		200 mΩ max.				
<b>Insulation resistance</b>	<b>Between non-connected terminals</b>	10 MΩ min. (at 250 VDC)		10 MΩ min. (at 500 VDC)		100 MΩ min. (at 500 VDC)
	<b>Between terminal and non-current carrying part</b>	100 MΩ min. (at 500 VDC)		1,000 MΩ min. (at 500 VDC)		
<b>Dielectric strength</b>	<b>Between non-connected terminals</b>	250 VAC, 50/60 Hz for 1 min	200 VAC, 50/60 Hz for 1 min	600 VAC, 50/60 Hz for 1 min		
	<b>Between terminal and non-current carrying part</b>	1,000 VAC, 50/60 Hz for 1 min				
<b>Vibration resistance</b>	<b>Malfunction</b>	10 to 55 Hz, 1.5-mm double amplitude				
<b>Shock resistance</b>	<b>Malfunction</b>	500 m/s <sup>2</sup> min. (approx. 50G)	490 m/s <sup>2</sup> min. (approx. 50G)	500 m/s <sup>2</sup> min. (approx. 50G)		
<b>Life expectancy</b>	<b>Mechanical</b>	30,000 operations min.		100,000 operations min.		2,000,000 operations min.
	<b>Electrical</b>	20,000 operations min.		50,000 operations min.		1,000,000 operations min.
<b>Ambient temperature (with no icing)</b>		Operating: -10°C to 70°C Storage: -20°C to 80°C	Operating: -10°C to 65°C Storage: -20°C to 80°C			
<b>Ambient humidity</b>		Operating: 45% to 85%	Operating: 35% to 85%	Operating: 45% to 85%		
<b>Max. operating force</b>		3.45 N (350 gf)	4.41 N (450 gf)	5.4 N (550 gf)	6.35 N (650 g)	

## Thumbwheel Switches

onlinecomponents.com

THE ONLINE DISTRIBUTOR OF ELECTRONIC COMPONENTS

Item		A7MD/A7MD-□□-D (see note 1)	A7MA-1/A7MA-2	A7SS	A7AS
Switching capacity (resistive load)		5 to 28 VDC 1 mA to 0.1 A		50 VAC to 28 VDC 1 mA to 0.1 A	
Continuous carry current		1 A max.			
Contact resistance		200 mΩ max., 10 Ω max. (see note 2)	200 mΩ max.		
Insulation resistance (see note 1)	Between non-connected terminals	10 MΩ min. (at 500 VDC)			
	Between terminal and non-current carrying part	1,000 MΩ min. (at 500 VDC)			
Dielectric strength (see note 1)	Between non-connected terminals	200 VAC, 50/60 Hz for 1 min		600 VAC, 50/60 Hz for 1 min	
	Between terminal and non-current carrying part	1,000 VAC, 50/60 Hz for 1 min			
Vibration resistance	Malfunction	10 to 55 Hz, 1.5-mm double amplitude			
Shock resistance	Malfunction	200 m/s <sup>2</sup> min. (approx. 20G)		490 m/s <sup>2</sup> min. (approx. 50G)	
Life expectancy	Mechanical	30,000 operations min.		1,000,000 operations min.	
	Electrical	20,000 operations min.		50,000 operations min.	
Ambient temperature (with no icing)		Operating: -10°C to 65°C Storage: -20°C to 80°C		Operating: -40°C to 85°C Storage: -40°C to 85°C	
Ambient humidity		Operating: 45% to 85%			
Max. operating force max.		2.95 N (300 gf)		3.9 N (400 gf)	

Note: 1. For A7MD(-D) with diode, the dielectric strength was measured at display of "0."

2. Contact resistance for A7MD(-D) with diode was evaluated at 6 to 8 VDC, 0.1 A. Reverse-direction voltage was 35 V (min.).

## Operation

### ■ Output Codes

Output code types are distinguished according to terminal numbers on Switch Units.

#### How to Read Output Codes

##### Example for Output Code 06

For example, when the dial position is "3," the common terminal C on the Switch Unit is connected to terminals 1 and 2, as indicated by the solid dots in the output code table. The internal circuitry is shown below.

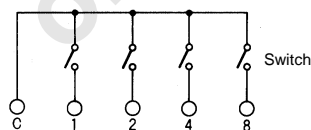

#### Reference

The internal circuit with diodes for the A7MD-106-P-09 is shown here, but the output condition and concepts are the same as those to the left.

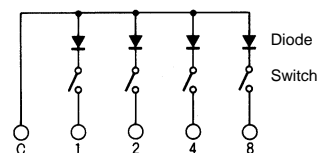

When a Switch is inserted into a Connector, e.g., for the A7BS, terminal C becomes connector terminal 2, and terminals 1 and 2 become connector terminals 4 and 5, respectively.

06: Binary-coded Decimal Output, Single-sided Board

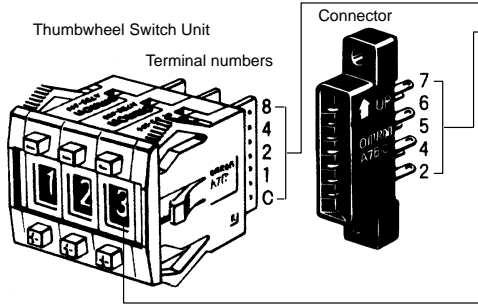

Model	Switch Unit or Connector	Common terminal number	Terminals connected to common			
A7BS	Switch Unit	C	1	2	4	8
	Connector	2	4	5	6	7
Dial	0					
	1		•			
	2			•		
	3		•	•		
	4				•	
	5		•		•	
	6			•	•	
	7		•	•	•	
	8					•
	9		•			•

The solid dot • indicates that the internal switch is ON.

**Output Code Types**

**Decimal Code**

03: Decimal Code Output

Model	Switch Unit or Connector	Common terminal number	Terminals connected to common										
A7SS A7AS A7PS A7PH	Switch Unit	C	0	1	2	3	4	5	6	7	8	9	
	Connector	6	1	2	3	4	5	7	8	9	10	11	
Dial	0		•										
	1			•									
	2				•								
	3					•							
	4						•						
	5							•					
	6								•				
	7									•			
	8										•		
	9											•	

**Binary Code**

01: Binary Code Output (+, - Switching)

Model	Switch Unit or Connector	Common terminal number	Terminals connected to common			
Dial	+		•		•	
	-			•		•
	:		:	:	:	:
	-		•		•	•

**PM Models**

- For models other than those listed on the left, use models with dials displaying "+, -, +, -, ..., -" instead of "0, 1, 2, ..., 9".
- These models end with a -PM.  
Example: A7BS-206-PM  
The output codes and terminals are the same as the A7BS-206; however, binary code output is used between output terminal 1 and the common terminal.

19: Decimal Code Output with Component-adding Provision

Model	Switch Unit or Connector	Common terminal number	Terminals connected to common										
A7SS A7AS A7PS A7PH	Switch Unit	C	0	1	2	3	4	5	6	7	8	9	
	Connector	6	1	2	3	4	5	7	8	9	10	11	
Dial	0		•										
	1			•									
	2				•								
	3					•							
	4						•						
	5							•					
	6								•				
	7									•			
	8										•		
	9											•	

Example of A7BS-206-PM

onlinecomponents.com Code Decimal

Model	Switch Unit or Connector	Common terminal number	Terminals connected to common			
			1	2	4	8
A7BS	Switch Unit	C				
	Connector	2	4	5	6	7
Dial	+ (0)					
	- (1)		•			
	+ (2)			•		
	- (3)		•	•		
	+ (4)				•	
	- (5)		•		•	
	+ (6)			•	•	
	- (7)		•	•	•	
	+ (8)					•
- (9)		•			•	

**Note:** 1. The solid dot • indicates that the internal switch is ON.  
 2. Numbers enclosed in parentheses are the dial displays for the A7BS-206.

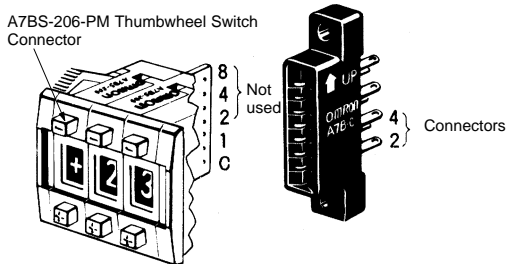

06: Binary-coded Decimal Output, Single-sided Board

Model	Switch Unit or Connector	Common terminal number	Terminals connected to common			
			1	2	4	8
A7BL A7BS	Switch Unit	C				
	Connector	2	4	5	6	7
A7MD (see note) A7MA (see note) A7SS A7DP A7D (see note) A7CN A7CN-L A7PS A7PH	Switch Unit	C	1	2	4	8
	Connector	3	5	7	9	11
Dial	0					
	1		•			
	2			•		
	3		•	•		
	4				•	
	5		•		•	
	6			•	•	
	7		•	•	•	
	8					•
9		•			•	

**Note:** There is no Connector on the A7MD, A7MA, A7D□, and A7C□.

22: Complementary Code of 06

Model	Switch Unit or connector	Common terminal number	Terminals connected to common			
			1	2	4	8
A7BS	Switch Unit	C				
	Connector	2	4	5	6	7
Dial	0		•	•	•	•
	1			•	•	•
	2		•		•	•
	3				•	•
	4		•	•		•
	5			•		•
	6		•			•
	7					•
	8		•	•	•	
9			•	•		



**07: Binary-code Decimal Output with Component-adding Provision**

Model	Switch Unit or Connector	Common terminal number	Terminals connected to common			
A7BL A7BS	Switch Unit	C	1	2	4	8
	Connector	1, 2	4	5	6	7
A7MA (see note) A7SS A7AS A7PS A7PH	Switch Unit	C	1	2	4	8
	Connector	1, 3	5	7	9	11
Dial	0					
	1		•			
	2			•		
	3		•	•		
	4				•	
	5		•		•	
	6			•	•	
	7		•	•	•	
	8					•
	9		•			•

**Note:** There is no Connector on the A7MA.

**54: Binary-coded Hexadecimal Output**

Model	Switch Unit or Connector	Common terminal number	Terminals connected to common			
A7BS	Switch Unit	C	1	2	4	8
	Connector	2	4	5	6	7
A7PS	Switch Unit	C	1	2	4	8
	Connector	3	5	7	9	11
Dial	0					
	1		•			
	2			•		
	3		•	•		
	4				•	
	5		•		•	
	6			•	•	
	7		•	•	•	
	8					•
	9		•			•
	A			•		•
	B		•	•		•
	C				•	•
	D		•		•	•
	E			•	•	•
	F		•	•	•	•

**55: Binary-coded Hexadecimal Output with Component-adding Provision**

Model	Switch Unit or Connector	Common terminal number	Terminals connected to common			
A7BS	Switch Unit	C	1	2	4	8
	Connector	1, 2	4	5	6	7
A7PS	Switch Unit	C	1	2	4	8
	Connector	1, 3	5	7	9	11
Dial	0					
	1		•			
	2			•		
	3		•	•		
	4				•	
	5		•		•	
	6			•	•	
	7		•	•	•	
	8					•
	9		•			•
	A			•		•
	B		•	•		•
	C				•	•
	D		•		•	•
	E			•	•	•
	F		•	•	•	•

# Dimensions

Note: All units are in millimeters unless otherwise indicated.

## ■ Push-operated Switches

**A7DP-206(-1)**  
PCB Terminals,  
Pen-push Model

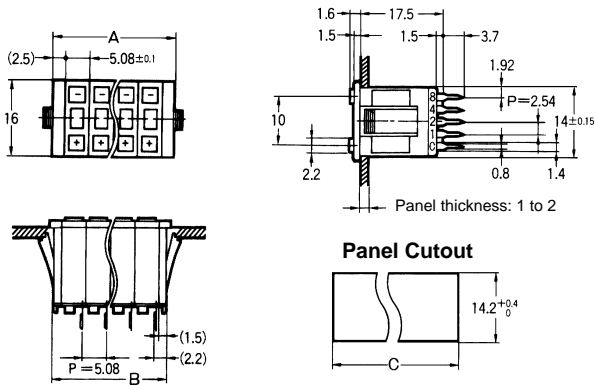

Note: Common terminal C is at the bottom when the Switch Unit is viewed from the front.

Number of Switches (n)	A (n x 5.1 + 5)	B (n x 5.1 + 3)	C
1	10.1 mm	8.1 mm	8.4 mm
2	15.2 mm	13.2 mm	13.5 mm
3	20.3 mm	18.3 mm	18.6 mm
4	25.4 mm	23.4 mm	23.7 mm
5	30.5 mm	28.5 mm	28.8 mm
6	35.5 mm	33.5 mm	33.9 mm
7	40.6 mm	38.6 mm	39.0 mm
8	45.7 mm	43.7 mm	44.1 mm
9	50.8 mm	48.8 mm	49.2 mm
10	55.9 mm	53.9 mm	54.3 mm

Note: 1. The dimensions above include both End Caps, and will increase 5.08 mm for each Spacer inserted.  
2. Unless otherwise specified, a tolerance of ±0.4 mm applies to all dimensions. The tolerance for multiple connection is ±(number of units x 0.4) mm.

**A7D-106(-1)**  
PCB Terminals

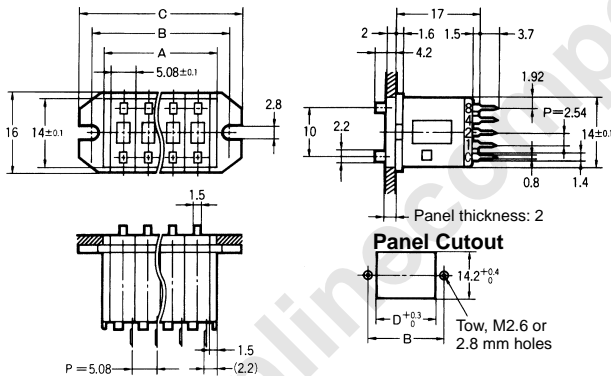
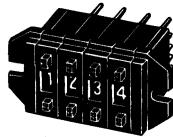

Note: Common terminal C is at the bottom when the Switch Unit is viewed from the front.

Number of Switches (n)	A (n x 5.1 + 3)	B (n x 5.1 + 8.3)	C (n x 5.1 + 13.3)	D
1	8.1 mm	13.4 mm	18.4 mm	8.4 mm
2	13.2 mm	18.5 mm	23.5 mm	13.5 mm
3	18.3 mm	23.6 mm	28.6 mm	18.6 mm
4	23.4 mm	28.7 mm	33.7 mm	23.7 mm
5	28.5 mm	33.8 mm	38.8 mm	28.8 mm
6	33.5 mm	38.9 mm	43.9 mm	33.9 mm
7	38.6 mm	44.0 mm	49.0 mm	39.0 mm
8	43.7 mm	49.1 mm	54.1 mm	44.1 mm
9	48.8 mm	54.2 mm	59.2 mm	49.2 mm
10	53.9 mm	59.3 mm	64.3 mm	54.3 mm

Note: 1. The dimensions above include both End Caps, and will increase 5.08 mm for each Spacer inserted.  
2. Unless otherwise specified, a tolerance of ±0.4 mm applies to all dimensions. The tolerance for multiple connection is ±(number of units x 0.4) mm.

**A7D-206(-1)  
PCB Terminals**



onlinecomponents.com  
THE ONLINE DISTRIBUTOR OF ELECTRONIC COMPONENTS

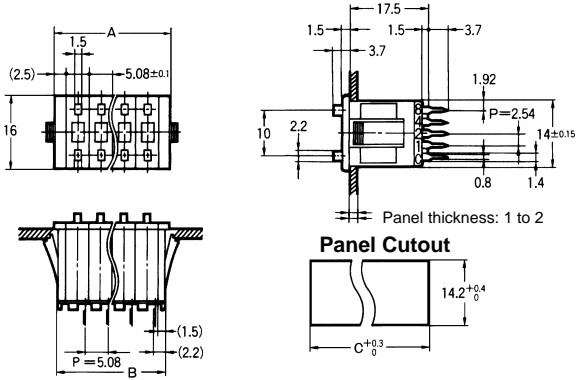

**Note:** Common terminal C is at the bottom when the Switch Unit is viewed from the front.

Number of Switches (n)	A (n x 5.1 + 5)	B (n x 5.1 + 3)	C (n x 5.1 + 3.3)
1	10.1 mm	8.1 mm	8.4 mm
2	15.2 mm	13.2 mm	13.5 mm
3	20.3 mm	18.3 mm	18.6 mm
4	25.4 mm	23.4 mm	23.7 mm
5	30.5 mm	28.5 mm	28.8 mm
6	35.5 mm	33.5 mm	33.9 mm
7	40.6 mm	38.6 mm	39.0 mm
8	45.7 mm	43.7 mm	44.1 mm
9	50.8 mm	48.8 mm	49.2 mm
10	55.9 mm	53.9 mm	54.3 mm

**Note:** 1. The dimensions above include both End Caps, and will increase 5.08 mm for each Spacer inserted.  
2. Unless otherwise specified, a tolerance of ±0.4 mm applies to all dimensions.  
The tolerance for multiple connection is ±(number of units x 0.4) mm.

**A7CN-106-1**

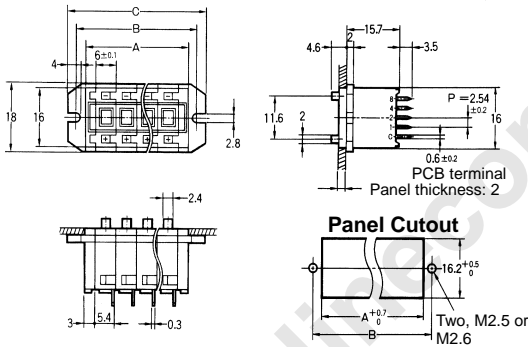
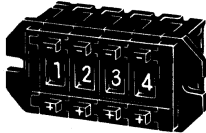

**Note:** Common terminal C is at the bottom when the Switch Unit is viewed from the front.

Number of Switches (n)	A (n x 6 + 6)	B (n x 6 + 11)	C (n x 6 + 16)
1	12 mm	17 mm	22 mm
2	18 mm	23 mm	28 mm
3	24 mm	29 mm	34 mm
4	30 mm	35 mm	40 mm
5	36 mm	41 mm	46 mm
6	42 mm	47 mm	52 mm
7	48 mm	53 mm	58 mm
8	54 mm	59 mm	64 mm
9	60 mm	65 mm	70 mm
10	66 mm	71 mm	76 mm

**Note:** 1. The dimensions above include both End Caps, and will increase 6 mm for each Spacer inserted.  
2. Unless otherwise specified, a tolerance of ±0.4 mm applies to all dimensions.  
The tolerance for multiple connection is ±(number of units x 0.4) mm.

A7CN-206(-1)

onlinecomponents.com  
THE ONLINE DISTRIBUTOR OF ELECTRONIC COMPONENTS

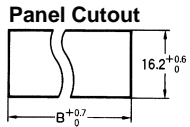
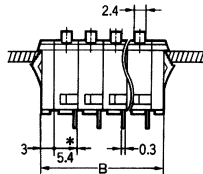
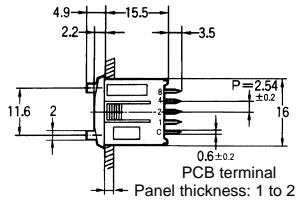
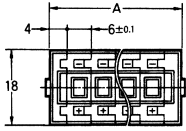
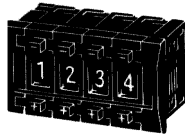

**Note:** Common terminal C is at the bottom when the Switch Unit is viewed from the front.

Number of Switches (n)	A (n x 6 + 8)	B (n x 6 + 6)
1	14 mm	12 mm
2	20 mm	18 mm
3	26 mm	24 mm
4	32 mm	30 mm
5	38 mm	36 mm
6	44 mm	42 mm
7	50 mm	48 mm
8	56 mm	54 mm
9	62 mm	60 mm
10	68 mm	66 mm

**Note:** 1. The dimensions above include both End Caps, and will increase 6 mm for each Spacer inserted.  
2. Unless otherwise specified, a tolerance of ±0.4 mm applies to all dimensions. The tolerance for multiple connection is ±(number of units x 0.4) mm.

A7CN-L206(-1)

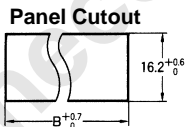
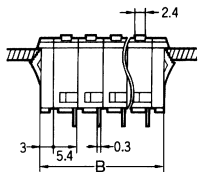
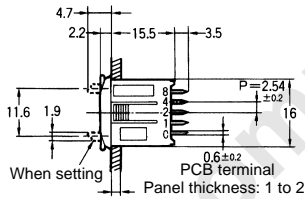
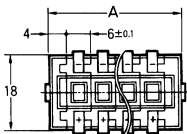
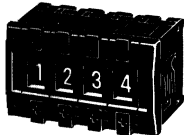

**Note:** Common terminal C is at the bottom when the Switch Unit is viewed from the front.

Number of Switches (n)	A (n x 6 + 8)	B (n x 6 + 6)
1	14 mm	12 mm
2	20 mm	18 mm
3	26 mm	24 mm
4	32 mm	30 mm
5	38 mm	36 mm
6	44 mm	42 mm
7	50 mm	48 mm
8	56 mm	54 mm
9	62 mm	60 mm
10	68 mm	66 mm

**Note:** 1. The dimensions above include both End Caps, and will increase 6 mm for each Spacer inserted.  
2. Unless otherwise specified, a tolerance of ±0.4 mm applies to all dimensions. The tolerance for multiple connection is ±(number of units x 0.4) mm.

**A7BL-206(-1)  
A7BL-207(-1)  
Solder Terminals,  
Locking Models**

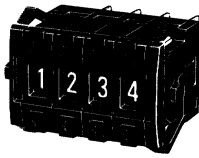

onlinecomponents.com  
THE ONLINE DISTRIBUTOR OF ELECTRICAL COMPONENTS

Number of Switches (n)	A (n x 8 + 8)	B (n x 8 + 6)	C
1	16 mm	14 mm	14.4 mm
2	24 mm	22 mm	22.4 mm
3	32 mm	30 mm	30.4 mm
4	40 mm	38 mm	38.4 mm
5	48 mm	46 mm	46.8 mm
6	56 mm	54 mm	54.8 mm
7	64 mm	62 mm	62.8 mm
8	72 mm	70 mm	70.8 mm
9	80 mm	78 mm	78.8 mm
10	88 mm	86 mm	86.8 mm

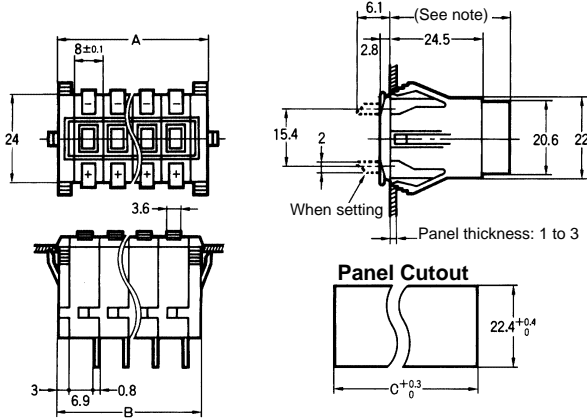

**Note:** If the output code is 06, the dimension is 32.5; if the output code is 07, the dimension is 43.5.

**Note:** 1. The dimensions above include both End Caps, and will increase 8 mm for each Spacer inserted.  
2. Unless otherwise specified, a tolerance of  $\pm 0.4$  mm applies to all dimensions. The tolerance for multiple connection is  $\pm(\text{number of units} \times 0.4)$  mm.

**A7BS-200(-1)  
A7BS-205(-1)  
Solder Terminals**

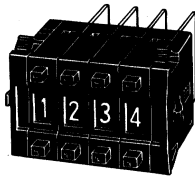

Number of Switches (n)	A (n x 8 + 8)	B (n x 8 + 6)	C
1	16 mm	14 mm	14.4 mm
2	24 mm	22 mm	22.4 mm
3	32 mm	30 mm	30.4 mm
4	40 mm	38 mm	38.4 mm
5	48 mm	46 mm	46.8 mm
6	56 mm	54 mm	54.8 mm
7	64 mm	62 mm	62.8 mm
8	72 mm	70 mm	70.8 mm
9	80 mm	78 mm	78.8 mm
10	88 mm	86 mm	86.8 mm

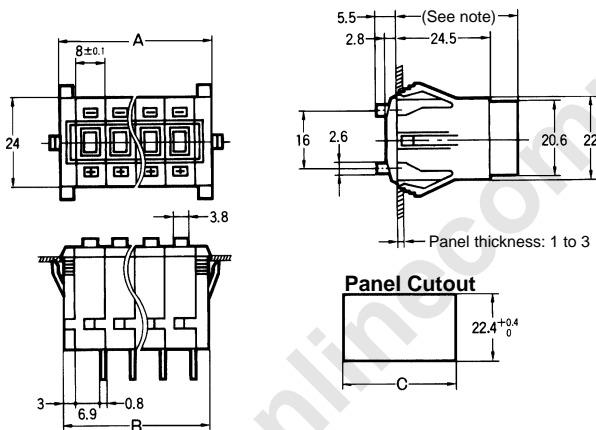

**Note:** If the output code is 06 or 54, the dimension is 32.5; if the output code is 07 or 55, the dimension is 43.5.

**Note:** 1. The dimensions above include both End Caps, and will increase 8 mm for each Spacer inserted.  
2. Unless otherwise specified, a tolerance of  $\pm 0.4$  mm applies to all dimensions. The tolerance for multiple connection is  $\pm(\text{number of units} \times 0.4)$  mm.

A7PS-2□□(-1)  
A7PH-2□□(-1)  
Solder Terminals

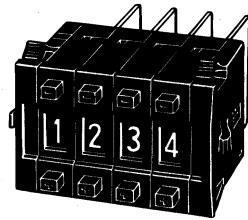

onlinecomponents.com  
THE ONLINE DISTRIBUTOR OF ELECTRONIC COMPONENTS

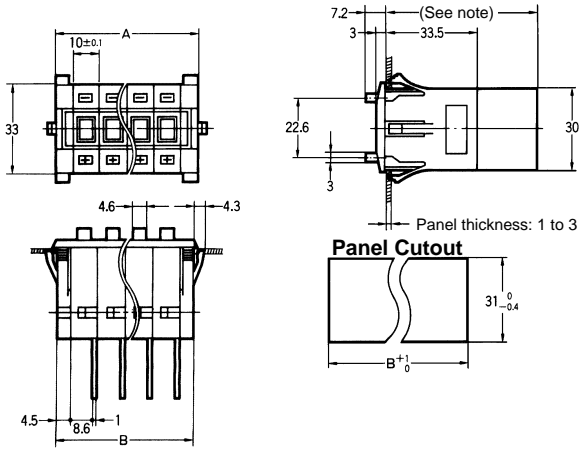

Number of Switches (n)	A (n x 10 + 12)	B (n x 10 + 9)
1	22 mm	19 mm
2	32 mm	29 mm
3	42 mm	39 mm
4	52 mm	49 mm
5	62 mm	59 mm
6	72 mm	69 mm
7	82 mm	79 mm
8	92 mm	89 mm
9	102 mm	99 mm
10	112 mm	109 mm

**Note:** 1. The dimensions above include both End Caps, and will increase 10 mm for each Spacer inserted.  
2. Unless otherwise specified, a tolerance of ±0.4 mm applies to all dimensions. The tolerance for multiple connection is ±(number of units x 0.4) mm.

**Note:** If the output code is 03, 06 or 54, the dimension is 43; if the output code is 07, 19 or 55, the dimension is 55.

### ■ Thumbwheel-operated Switches

A7MD-106-P-09  
A7MD-106-P-09-D  
PCB Terminals

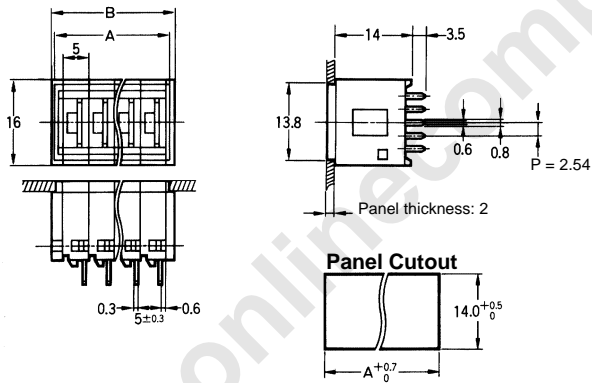
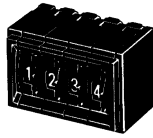

Number of Switches (n)	A (5n + 3)	B (5n + 5)
1	8 mm	10 mm
2	13 mm	15 mm
3	18 mm	20 mm
4	23 mm	25 mm
5	28 mm	30 mm
6	33 mm	35 mm
7	38 mm	40 mm
8	43 mm	45 mm
9	48 mm	50 mm
10	53 mm	55 mm

**Note:** 1. The dimensions above include both End Caps, and will increase 6 mm for each Spacer inserted.  
2. Unless otherwise specified, a tolerance of ±0.4 mm applies to all dimensions. The tolerance for multiple connection is ±(number of units x 0.4) mm.

A7MA-1 Solder Terminals

onlinecomponents.com  
THE ONLINE DISTRIBUTOR OF ELECTRONIC COMPONENTS

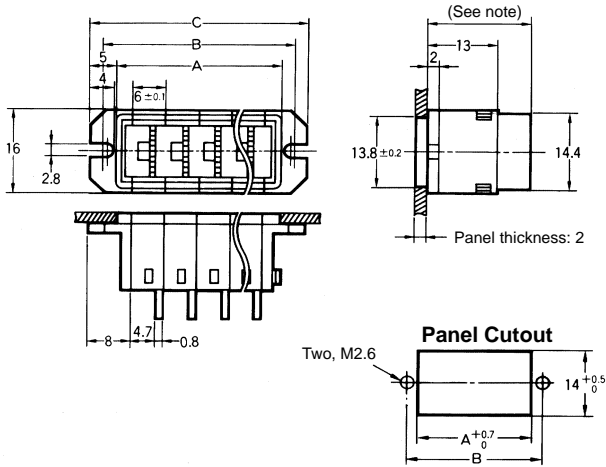
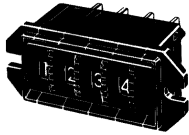

Number of Switches (n)	A (6n + 6)	B (6n + 11)	C (6n + 16)
1	12 mm	17 mm	22 mm
2	18 mm	23 mm	28 mm
3	24 mm	29 mm	34 mm
4	30 mm	35 mm	40 mm
5	36 mm	41 mm	46 mm
6	42 mm	47 mm	52 mm
7	48 mm	53 mm	58 mm
8	54 mm	59 mm	64 mm
9	60 mm	65 mm	70 mm
10	66 mm	71 mm	76 mm

- Note:**
1. The dimensions above include both End Caps, and will increase 6 mm for each Spacer inserted.
  2. Unless otherwise specified, a tolerance of  $\pm 0.4$  mm applies to all dimensions. The tolerance for multiple connection is  $\pm(\text{number of units} \times 0.4)$  mm.

**Note:** If the output code is 06, the dimension is 19; if the output code is 07, the dimension is 31.

A7MA-1-P2 PCB Terminals

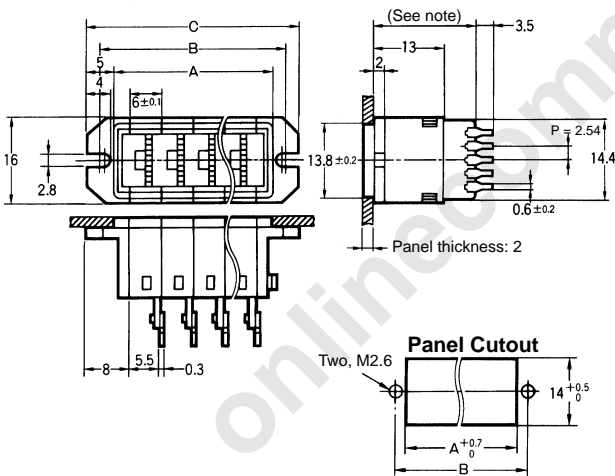
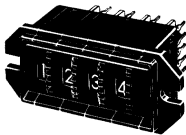

**Note:** If the output code is 06, the dimension is 19; if the output code is 07, the dimension is 31.

**A7MA-2□□(-1)  
Solder Terminals**

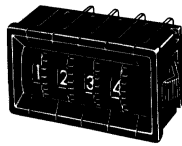

onlinecomponents.com  
THE ONLINE DISTRIBUTOR OF ELECTRONIC COMPONENTS

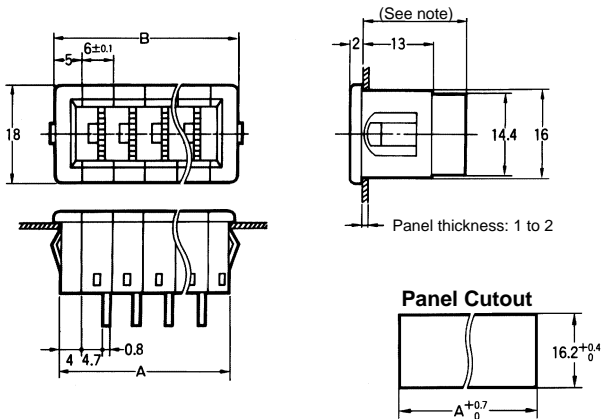

**Note:** If the output code is 06, the dimension is 19; if the output code is 07, the dimension is 31.

Number of Switches (n)	A (6n + 8)	B (6n + 10)
1	14 mm	16 mm
2	20 mm	22 mm
3	26 mm	28 mm
4	32 mm	34 mm
5	38 mm	40 mm
6	44 mm	46 mm
7	50 mm	52 mm
8	56 mm	58 mm
9	62 mm	64 mm
10	68 mm	70 mm

**Note:** 1. The dimensions above include both End Caps, and will increase 6 mm for each Spacer inserted.  
2. Unless otherwise specified, a tolerance of ±0.4 mm applies to all dimensions. The tolerance for multiple connection is ±(number of units x 0.4) mm.

**A7MA-2□□-P2(-1)  
PCB Terminals**

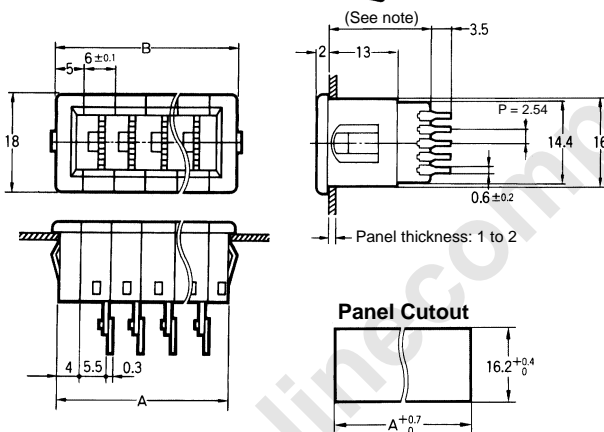
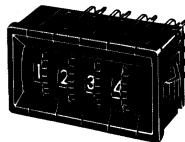

**Note:** If the output code is 06, the dimension is 19; if the output code is 07, the dimension is 31.

Number of Switches (n)	A (6n + 8)	B (6n + 10)
1	14 mm	16 mm
2	20 mm	22 mm
3	26 mm	28 mm
4	32 mm	34 mm
5	38 mm	40 mm
6	44 mm	46 mm
7	50 mm	52 mm
8	56 mm	58 mm
9	62 mm	64 mm
10	68 mm	70 mm

**Note:** 1. The dimensions above include both End Caps, and will increase 6 mm for each Spacer inserted.  
2. Unless otherwise specified, a tolerance of ±0.4 mm applies to all dimensions. The tolerance for multiple connection is ±(number of units x 0.4) mm.



**A7SS-1** Solder Terminals

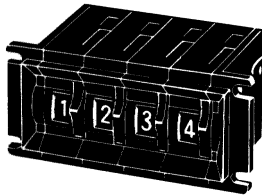

onlinecomponents.com  
THE ONLINE DISTRIBUTOR OF ELECTRONIC COMPONENTS

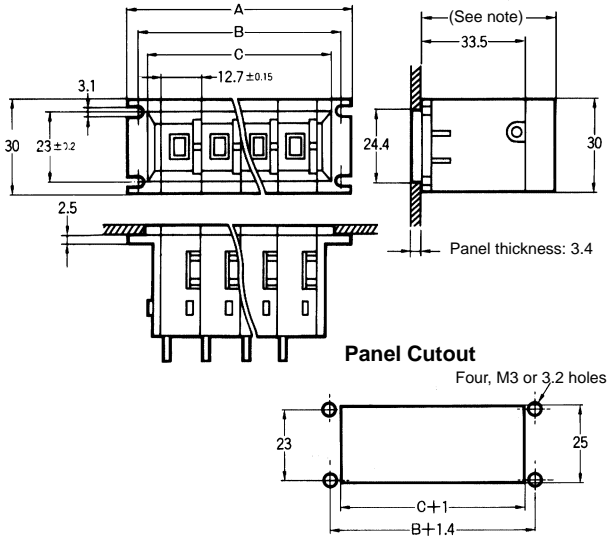

**Note:** If the output code is 03 or 06, the dimension is 43; if the output code is 07, the dimension is 55.

Number of Switches (n)	A (12.7n + 22)	B (12.7n + 14.8)	C (12.7n + 10)
1	34.7 mm	27.5 mm	22.7 mm
2	47.4 mm	40.2 mm	35.4 mm
3	60.1 mm	52.9 mm	48.1 mm
4	72.8 mm	65.6 mm	60.8 mm
5	85.5 mm	78.3 mm	73.5 mm
6	98.2 mm	91.0 mm	86.2 mm
7	110.9 mm	103.7 mm	98.9 mm
8	123.6 mm	116.4 mm	111.6 mm
9	136.3 mm	129.1 mm	124.3 mm
10	149.0 mm	141.8 mm	137.0 mm

**Note:** 1. The dimensions above include both End Caps, and will increase 12.7 mm for each additional Switch inserted (6.35-mm wide Spacers are also available).  
2. Unless otherwise specified, a tolerance of ±0.4 mm applies to all dimensions. The tolerance for multiple connection is ±(number of units x 0.4) mm.

**A7AS-2** Solder terminals

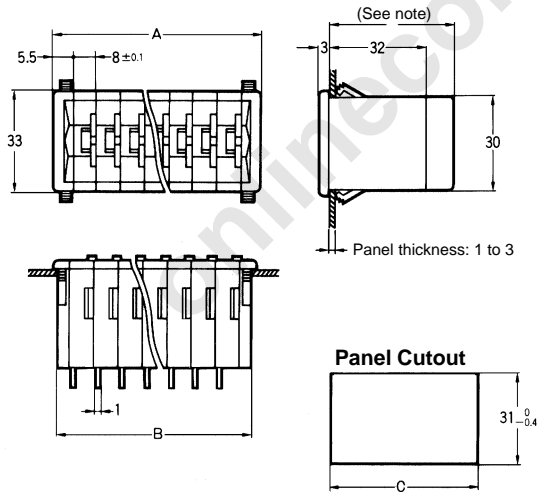
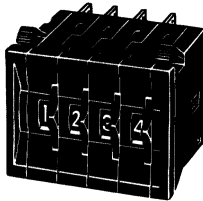

**Note:** If the output code is 03 or 06, the dimension is 41.5; if the output code is 07 or 19, the dimension is 55.

Number of Switches (n)	A (8n + 11)	B (8n + 8)	C (B + 1)
1	19 mm	16 mm	17 mm
2	27 mm	24 mm	25 mm
3	35 mm	32 mm	33 mm
4	43 mm	40 mm	41 mm
5	51 mm	48 mm	49 mm
6	59 mm	56 mm	57 mm
7	67 mm	64 mm	65 mm
8	75 mm	72 mm	73 mm
9	83 mm	80 mm	81 mm
10	91 mm	88 mm	89 mm

**Note:** 1. The dimensions above include both End Caps, and will increase 8 mm for each additional Switch inserted.  
2. Unless otherwise specified, a tolerance of ±0.4 mm applies to all dimensions. The tolerance for multiple connection is ±(number of units x 0.4) mm.

■ Accessories (Order Separately) [onlinecomponents.com](http://onlinecomponents.com)  
THE ONLINE DISTRIBUTOR OF ELECTRONIC COMPONENTS  
**End Caps for Push-operated Switches**

**A7D-1M(-1) Screw Mounting (Back Mounting)**

Left Side

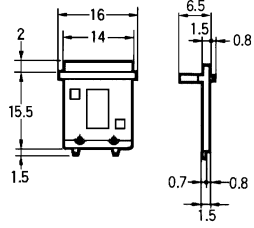

Right Side

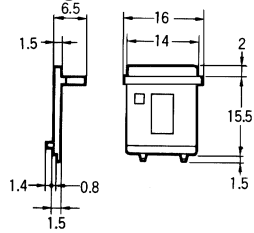

**A7D-2M(-1) Snap-in Mounting (Front Mounting)**

Left Side

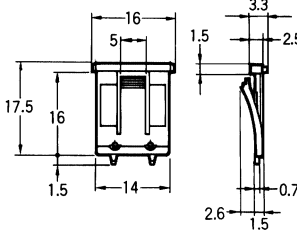

Right Side

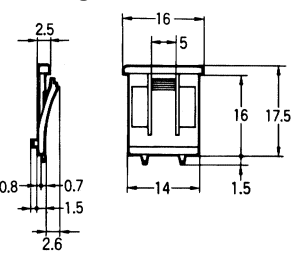

**A7CN-1M-1 Screw Mounting**

Left Side

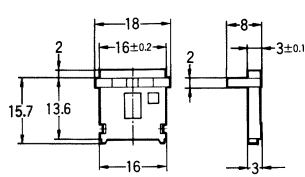

Right Side

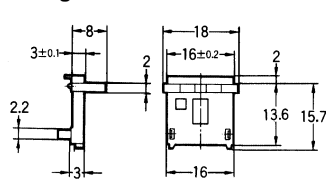

**A7CN-2M-1 Snap-in Mounting**

Left Side

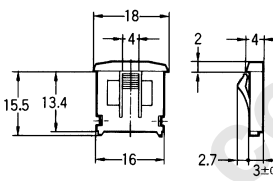

Right Side

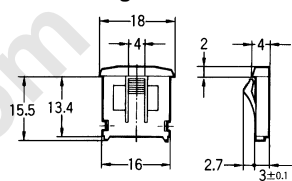

**A7B-M(-1) Snap-in Panel Mounting**

Left Side

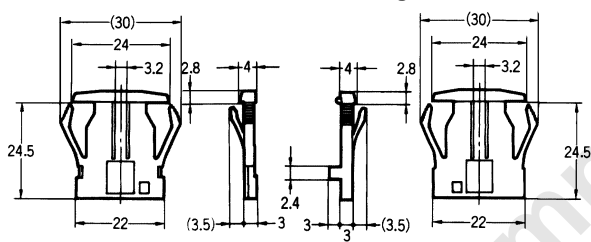

Right Side

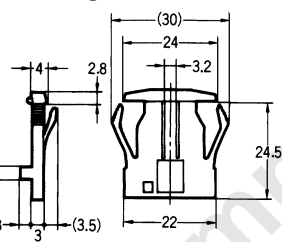

**A7P-M(-1) Snap-in Panel Mounting**

Left Side

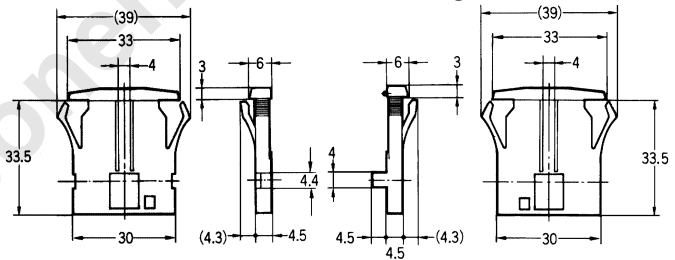

Right Side

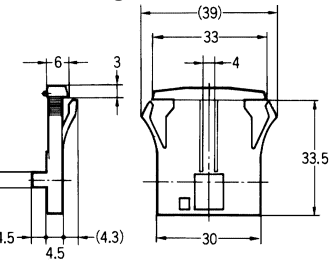

End Caps for Thumbwheel Switches

onlinecomponents.com  
THE ONLINE DISTRIBUTOR OF ELECTRONIC COMPONENTS

A7MD-1M PCB Mounting (Side Plate)

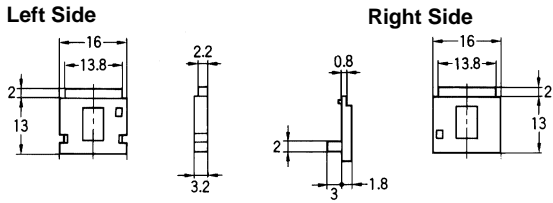

A7M-1M Screw Panel Mounting

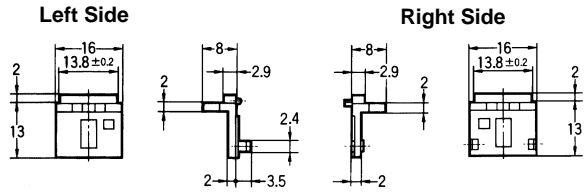

**Note:** The A7MD cannot be mounted by a screw panel or snap-in panel. Fasten the PC board after mounting the A7MD to the PC board.

A7M-2M(-1) Snap-in Panel Mounting

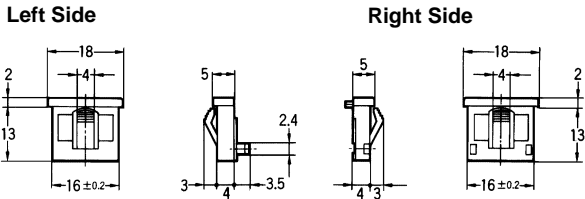

A7SS-M and SRT-M Screw Panel Mounting

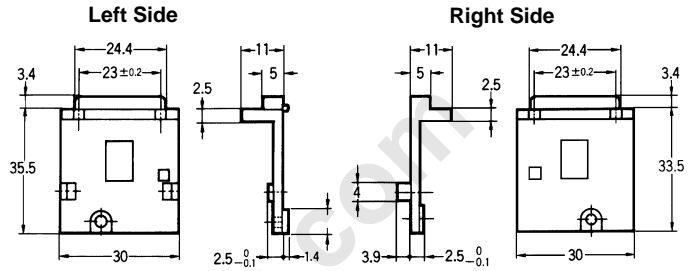

A7AS-M(-1) Snap-in Panel Mounting

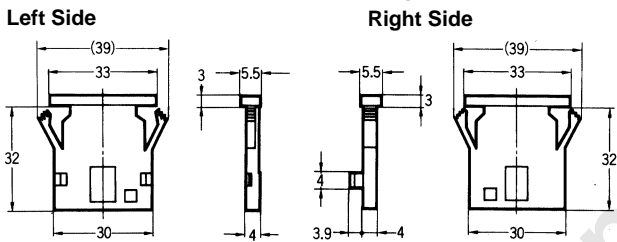

Spacers for Push-operated Switches

A7D-1PA(-1) Screw Mounting (Back Mounting)

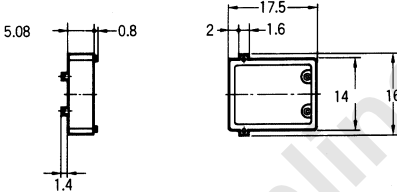

A7D-2PA(-1) Snap-in Mounting (Front Mounting)

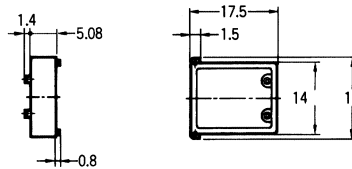

A7CN-1P-1 Screw Panel Mounting Model

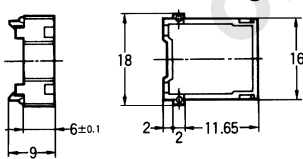

A7CN-2P-1 Snap-in Mounting Model

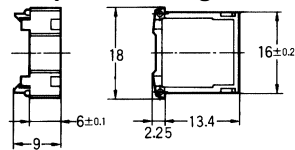

A7B-PA(-1) Snap-in Panel Mounting

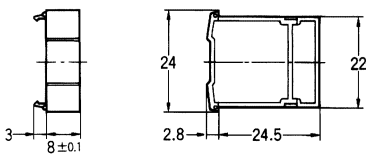

A7P-PA(-1) Snap-in Panel Mounting

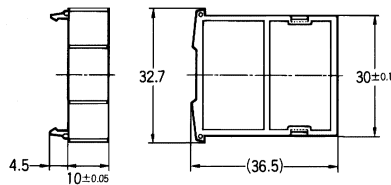

Spacers for Thumbwheel Switches

onlinecomponents.com  
THE ONLINE DISTRIBUTOR OF ELECTRONIC COMPONENTS

A7MD-PA PCB Mounting

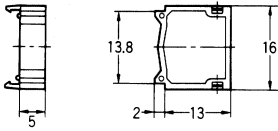

A7M-1PA Screw Panel Mounting

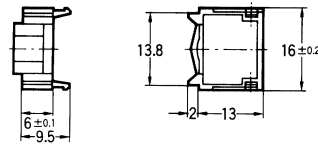

A7M-2PA(-1) Snap-in Panel Mounting

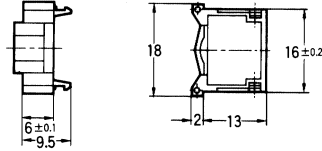

Stamping

When units of time or lengths are required, stamping any of the additional Switches and Spacers above with text or symbols is possible. Designate the desired stamping by symbol to substitute the "A" for the "-PA" on the model numbers according to the table below.

Symbol	A	B	C	D	E	F	G	H	J	K	L	Q	T	U
Stamp	No designation	SEC	MIN	H	g	kg	mm	cm	m	°C	PCS	x 10 SEC	0	•

Stopper Pins (for Only the A7BS-20□-S)

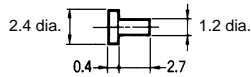

- Note:**
- Two pins constitute one set.
  - The first shipment is free and is attached to the Switch.

Connectors

These devices allow Switches to be quickly removed for maintenance and inspection of connectivity, and quickly re-installed.

A7B-C Solder Terminals

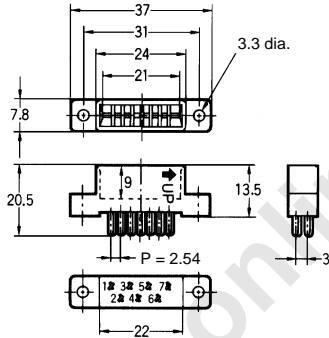

A7B-CP PCB Terminals

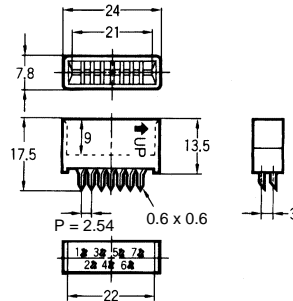

Inserting Connectors

Insert Connectors with the "UP" arrow pointing up.

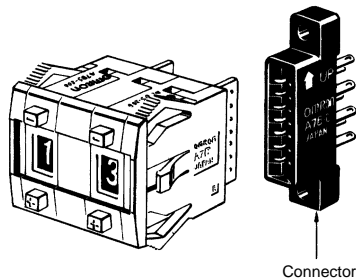

**Note:** Unless otherwise indicated, dimensional tolerances for dimensions in the models above are ±0.4 mm.

# Installation

## ■ Terminals

### Push-operated Switches

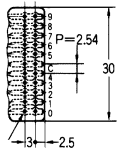
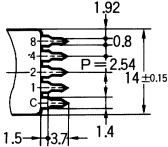
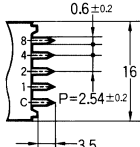
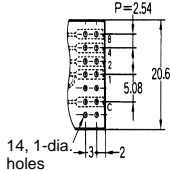
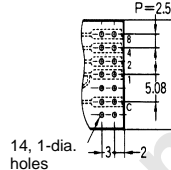
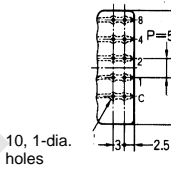
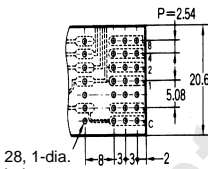
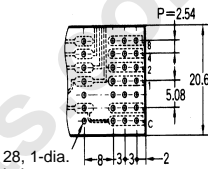
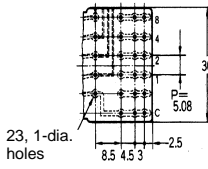
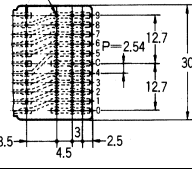
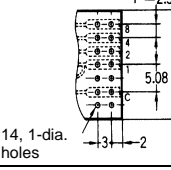
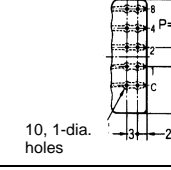
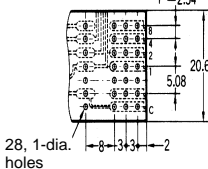
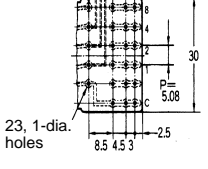
Output code	A7DP-2/A7D-1 /A7D-2 (PCB terminals)	A7CN-2/A7CN-1 /A7CN-L (PCB terminals)	A7BL (solder terminals)	A7BS/A7BS-20-S (solder terminals)	A7PS/A7PH (solder terminals)
03	---	--	--	--	 22, 1-dia. holes
06					
07	---	--			
19	---	--	---	---	
54	---	--	---		
55	---	--	---		

Thumbwheel Switches

onlinecomponents.com

Output code	A7MD (PCB terminals)	A7MA-□ (solder terminals)	A7MA-□-P2 (PCB terminals)	A7SS/A7AS (solder terminals)
01	--	--	--	--
03	--	--	--	
06 (13)				
07 (36)	--			
08	--	--	--	--
19	--	--	--	
22	--	--	--	--

onlinecomponents.com

Switches with Component-adding Provision [onlinecomponents.com](http://onlinecomponents.com)

To add diodes or resistors to Thumbwheel Switch circuits, use models with terminals that allocate component-adding provisions (e.g., output codes 07, 19, 55, etc.).

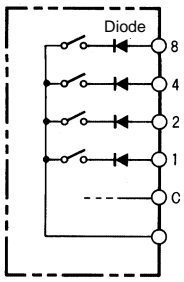
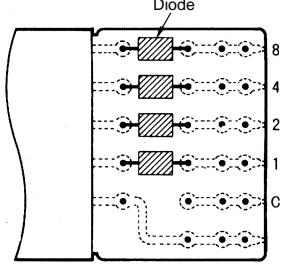
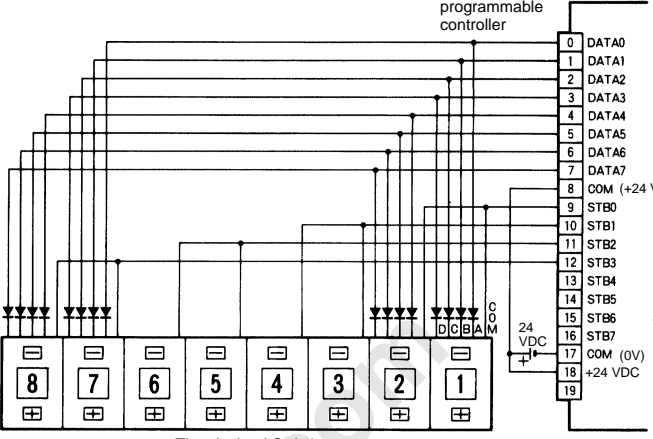
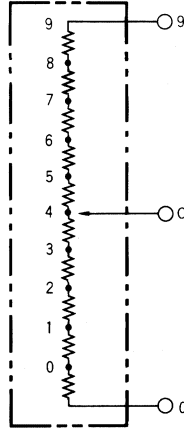
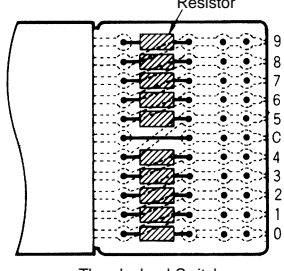
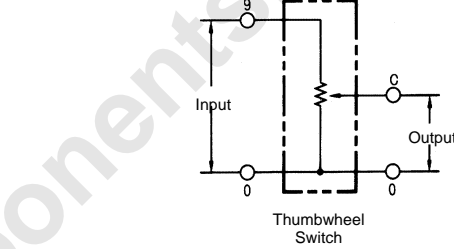
Examples	Circuit example	Circuit board	Application example
<p><b>For mounting diodes</b></p>	 <p>Thumbwheel Switch</p>	 <p>Thumbwheel Switch (e.g., A7PS-207)</p> <p><b>Note:</b> Use the terminal marked with the asterisk * if the common terminal needs no resistor or diode.</p>	<p>For Programmable Controller inputs (OMRON C500 or C2000H)</p>  <p>Thumbwheel Switch</p>
<p><b>For mounting resistors</b></p>	 <p>Thumbwheel Switch</p>	 <p>Thumbwheel Switch (e.g., A7PS-219)</p>	<p>As a voltage divider or digital variable resistor</p>  <p>Thumbwheel Switch</p>

# Precautions

onlinecomponents.com  
THE ONLINE DISTRIBUTOR OF ELECTRONIC COMPONENTS

## Environment

Do not use where gases are generated (ammonia, chlorine, sulfur dioxide).

Although Switches are of nearly dust-proof construction, they are not drip-proof, therefore do not use in areas subject to water or oil exposure and do not operate with wet or oily hands. (The A7MD has a dust-proof construction on contact parts, but consider your installation location carefully. The A7MA is not of dust-proof construction.)

Provide additional dust-proofing measure when using in sand-exposed areas.

## Setting Numbers

### Locking Type

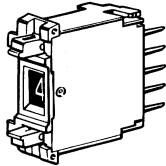

Set with the setting button by raising it.

Return the button to its original position after setting. It is then locked to prevent rotation, and the set numbers will not change accidentally.

### Pen-push Type

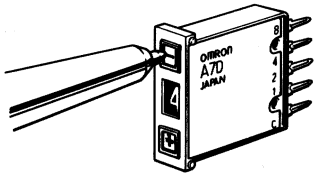

To set, press the setting button with a ball-point pen or other pointed object. However, avoid using pencils or mechanical pencils as broken lead or lead dust may enter and damage the Switch.

## Handling

Use alcohol to wipe off dirt and smudges from the molded-plastic cases. Take care to prevent the alcohol from getting inside.

Do not use thinner or other solutions which might damage the plastic.

When connecting Switches, fit the mating parts together.

When separating Switches, use a screwdriver as shown in the figure below; disconnect them by releasing the top and bottom hooks.

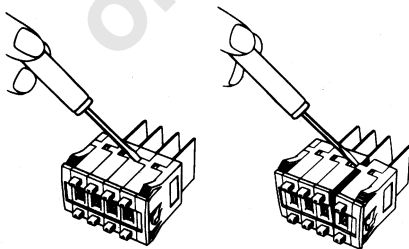

Do not push the (+) and (-) operating push-buttons at the same time with undue force.

## Terminals for PCB Models

When using terminals for printed circuit boards, make the terminal insertion holes in the back board (mother board) 1 mm or larger in diameter.

Do not use excessive force in handling terminals for printed circuit boards. In particular, take care to avoid dropping them as the terminals might bend or break.

Reference: Terminals can withstand a force of 0.8 g for 1 minute or more, and survive bending of 20° without breaking after returning to original position.

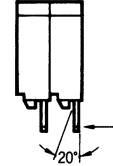

The A7MD accommodates only printed circuit boards. When pulling out the operating surface from the back of the panel, refer to the figures for panel mounting dimensions. However, it cannot be fastened alone to the panel.

## Connectors

Insert Connectors while keeping the arrow pointing up (refer to page 31).

Connector insertion load is about 1.5 kg for each A7B-C.

## Setting the Stopper (A7BS-20□-S)

With the A7BS-20□-S, any range can be set outside with the Stopper Pin. Insert the Stopper Pin using the following procedure:

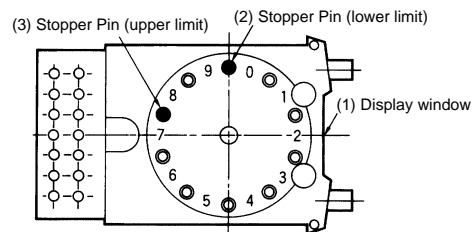

### Example: To Display the Range 0 to 7

- Any number within the range of (0 to 7) can be chosen to limit the numbers displayed in the display window. (In this example, 8 and 9 are outside of this range.)
- First, insert the Stopper Pin in the hole in front of the lower limit ("0") for the number to be defined.
- Next, insert the Stopper Pin in the hole past the upper limit ("7") for the number to be defined. (The Stopper Pins then surround the exact range to be defined.)

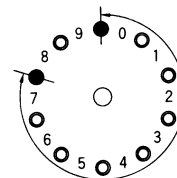

- Confirm that the (+) push-button can no longer be pushed after reaching the upper limit of ("7").



5. Confirm that the (–) push-button can no longer be pushed after reaching the lower limit of ("0"). This completes the setting.

For Stoppers other than those for the A7BS-20-S, refer to pages 5 to 11 of the *Selection Guide* as well as the ordering information on page 15. All manufactured Switches have their ranges factory-set before shipment.

## Soldering

Note the following points when soldering printed circuit boards:

### Automatic Soldering

After coating with flux foam 1, dip into a soldering tank 2. Thereafter, do not dip to clean. There is no danger of flux penetration in processes 1 and 2, but penetration will occur with dip cleaning, causing contact and rotational defects. Clean the flux as shown in Figure 1, tilting the Switch 45° or more and using a brush to apply the solvent only to the back of the board. It may also be cleaned by dipping only the back of the board into solvent and then using a brush to clean.

Figure 1

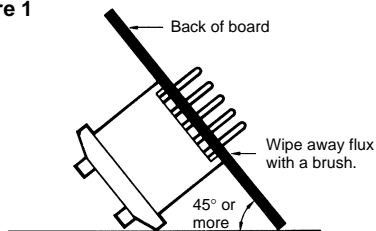

### Dip Soldering

Dip into flux solvent 1, and then into a soldering tank 2. The dipping time in process 1 is a maximum of 2 seconds. As shown in Figure 2, avoid flooding the top surface of the printed circuit board with flux. Using a brush to apply flux further reduces the danger of flux penetration. As shown in Figure 2, a brush should be used while tilting the board 45° or more. Flush flux as described above under *Automatic Soldering*.

Figure 2

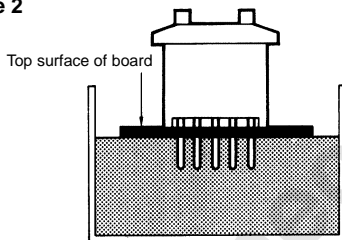

### Using a Soldering Iron

Use a 30-W soldering iron at a temperature of 350°C for a maximum of 3 seconds, and flush as described above.