

SMD Schottky Barrier Rectifiers



SMD Diodes Specialist

CDBA120-HF Thru. CDBA1100-HF

Reverse Voltage: 20 to 100 Volts

Forward Current: 1.0 Amp

RoHS Device

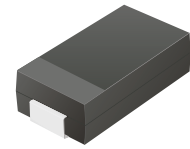

Features

- Halogen free.
- Ideal for surface mount applications.
- Easy pick and place.
- Plastic package has Underwriters Lab. flammability classification 94V-0.
- Built-in strain relief.
- Low forward voltage drop.

Mechanical data

- Case: JEDEC DO-214AC, molded plastic.
- Terminals: solderable per MIL-STD-750, method 2026.
- Polarity: Color band denotes cathode end.
- Approx. weight: 0.056 grams

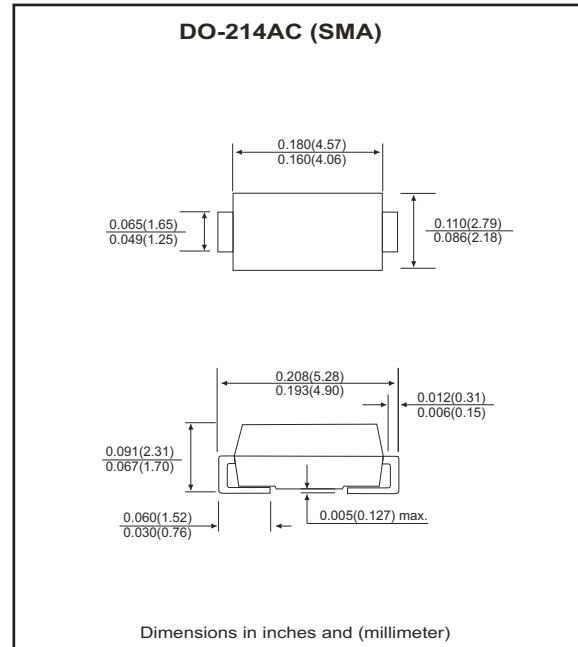

Maximum Ratings and Electrical Characteristics

Parameter	Symbol	CDBA 120-HF	CDBA 140-HF	CDBA 160-HF	CDBA 180-HF	CDBA 1100-HF	Units	
Max. repetitive peak reverse voltage	V_{RRM}	20	40	60	80	100	V	
Max. DC blocking voltage	V_{DC}	20	40	60	80	100	V	
Max. RMS voltage	V_{RMS}	14	28	42	56	70	V	
Peak surge forward current, 8.3ms single half sine-wave superimposed on rate load (JEDEC method)	I_{FSM}	30						A
Max. average forward current	I_o	1.0						A
Max. instantaneous forward voltage at 1.0A	V_F	0.50		0.70	0.85		V	
Max. DC reverse current at $T_A=25\text{ }^\circ\text{C}$ rated DC blocking voltage $T_A=100\text{ }^\circ\text{C}$	I_R				0.5 10			mA
Max. thermal resistance (Note 1)	$R_{\theta JA}$ $R_{\theta JL}$				88 20			$^\circ\text{C/W}$
Max. operating junction temperature	T_J	125						$^\circ\text{C}$
Storage temperature	T_{STG}	-65 to +150						$^\circ\text{C}$

Notes: 1. Thermal resistance from junction to ambient and junction to lead mounted on P.C.B. with 0.2×0.2 inch copper pad area.

RATING AND CHARACTERISTIC CURVES (CDBA120-HF thru CDBA1100-HF)

Fig.1 Reverse Characteristics

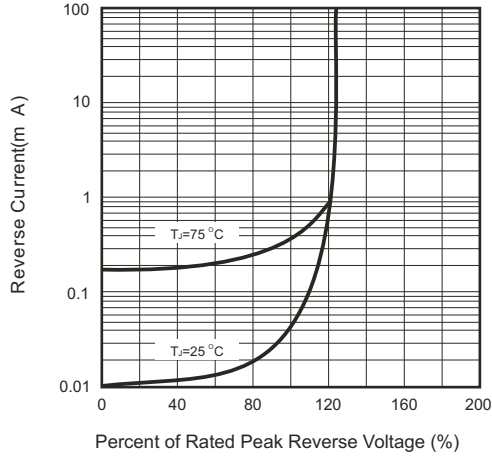

Fig.2 Forward Characteristics

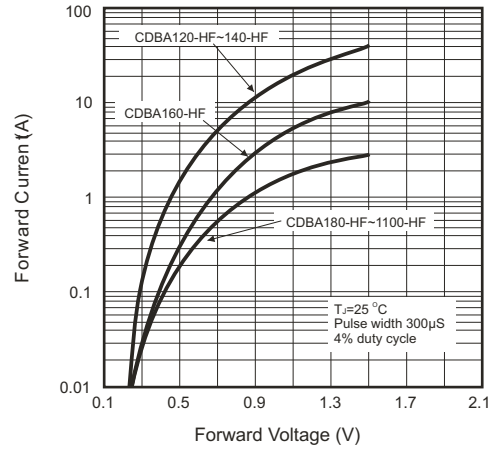

Fig.3 Junction Capacitance

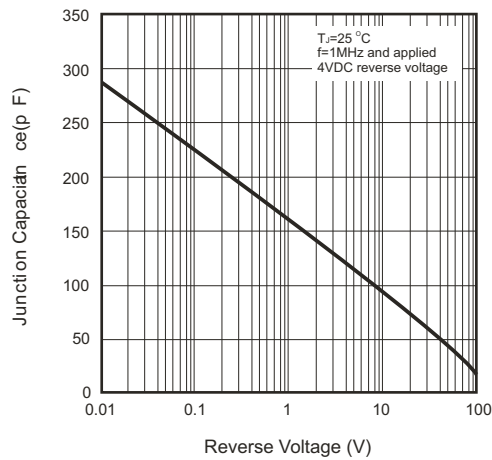

Fig.4 Current Derating Curve

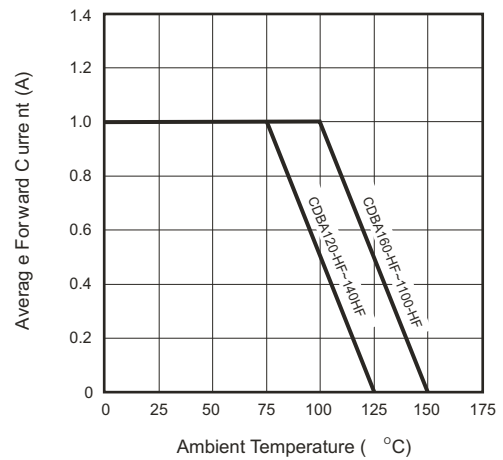
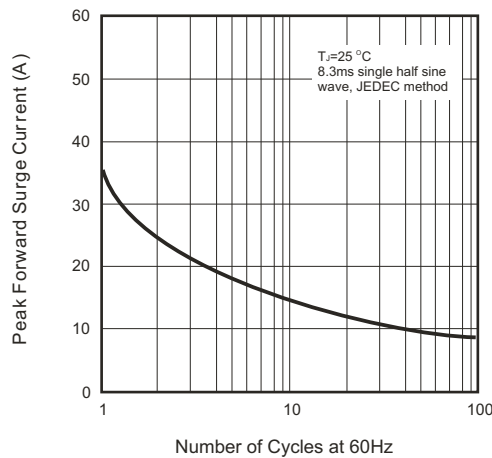
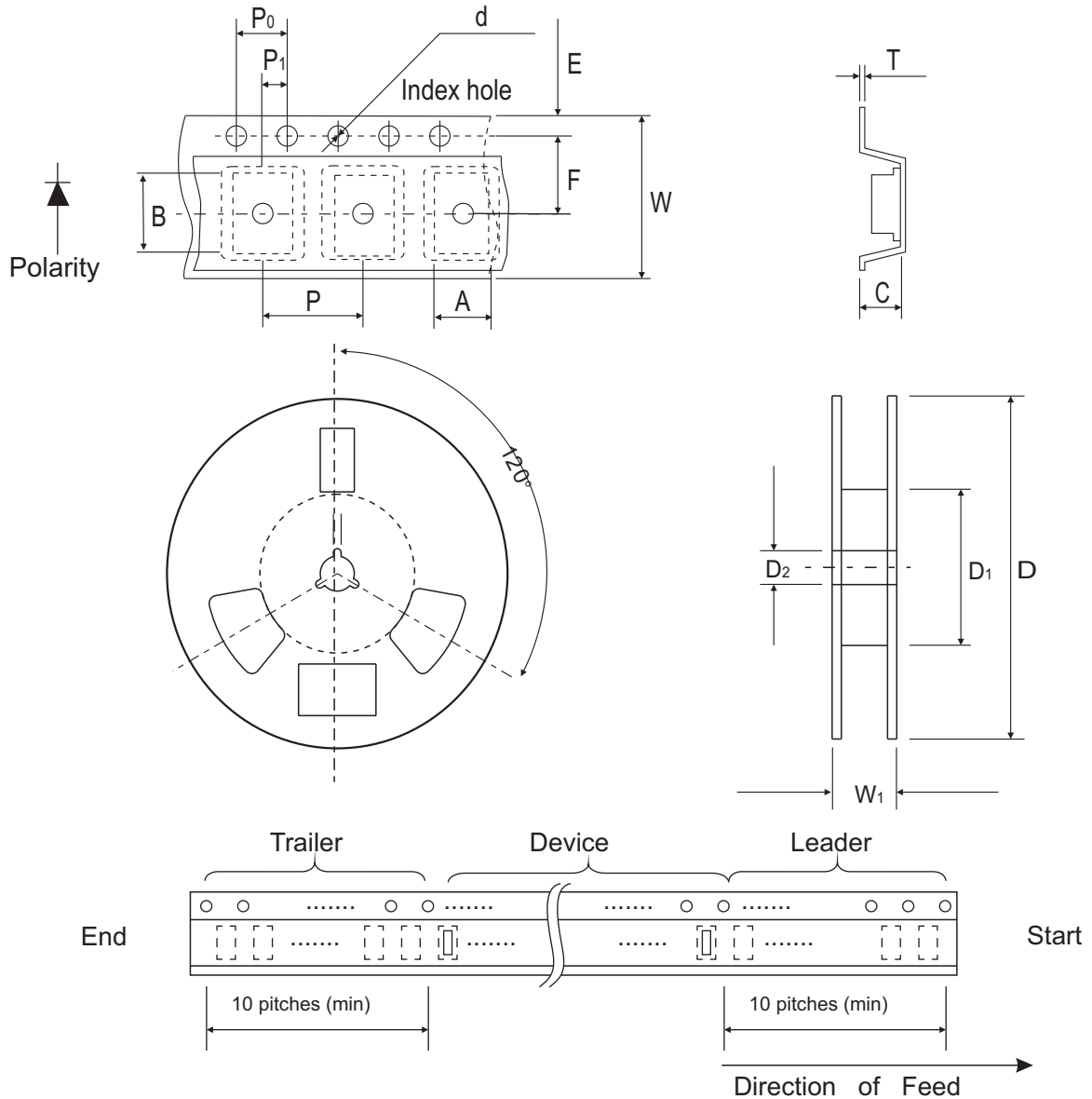

Fig.5 Non-repetitive Forward Surge Current



Reel Taping Specification



SMA (DO-214AC)	SYMBOL	A	B	C	d	D	D ₁	D ₂
	(mm)	2.70 (max)	5.30 (max)	2.66 (max)	1.50 ± 0.10	330	50.0 MIN.	13.5 ± 1.00
	(inch)	0.106 (max)	0.209 (max)	0.105 (max)	0.059 ± 0.004	12.99	1.969 MIN.	0.531 ± 0.039

SMA (DO-214AC)	SYMBOL	E	F	P	P ₀	P ₁	W	W ₁
	(mm)	1.75 ± 0.10	5.50 ± 0.05	4.00 ± 0.10	4.00 ± 0.10	2.00 ± 0.05	12.0 ± 0.20	18.4 (max)
	(inch)	0.689 ± 0.004	0.217 ± 0.002	0.157 ± 0.004	0.157 ± 0.004	0.079 ± 0.002	0.472 ± 0.008	0.724 (max)

Marking Code

Part Number	Marking Code
CDBA120-HF	120
CDBA140-HF	140
CDBA160-HF	160
CDBA180-HF	180
CDBA1100-HF	1100



xxxx = Product type marking code

Suggested PAD Layout

SIZE	DO-214AC(SMA)	
	(mm)	(inch)
A	3.80	0.150
B	1.60	0.063
C	2.80	0.110
D	5.40	0.213
E	2.20	0.087

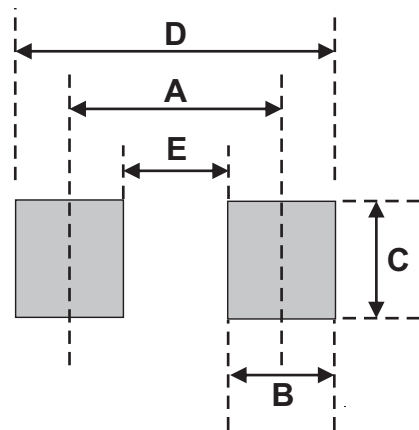

Standard Package

Case Type	Qty per Reel	Reel Size
	(Pcs)	(inch)
DO-214AC (SMA)	5000	13

Mouser Electronics

Authorized Distributor

Click to View Pricing, Inventory, Delivery & Lifecycle Information:

[Comchip Technology:](#)

[CDBA140-HF](#)