

C1005CH1H471K050BA

TDK Item Description : C1005CH1H471KT****



Application & Main Feature

Commercial Grade (General (Up to 50V))

Series

C1005 [EIA CC0402]

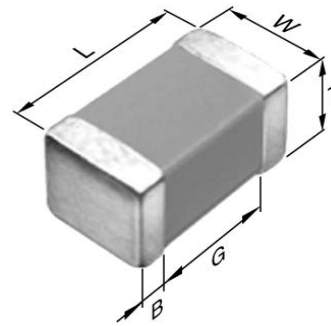

Dimensions

L 1.00mm +/-0.05mm
W 0.50mm +/-0.05mm
T 0.50mm +/-0.05mm
B 0.10mm Min.
G 0.30mm Min.

Temperature Characteristic

CH (-25 to 85 degC 0+/-60ppm/degC)

Rated Voltage

1H (50Vdc)

Capacitance

470pF

Capacitance Tolerance

K (+/-10%)

Q Factor

1000 Min.

Insulation Resistance

10Gohm Min.

AEC-Q200

Not Applicable

|Z|, ESR vs. Freq. Characteristics

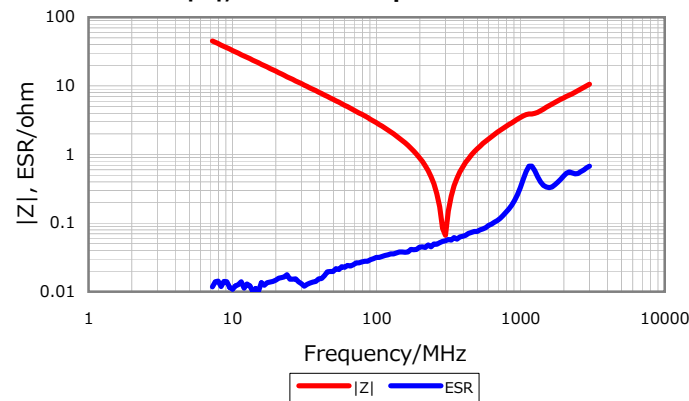

DC Bias Characteristic



Cap. vs. Freq. Characteristic

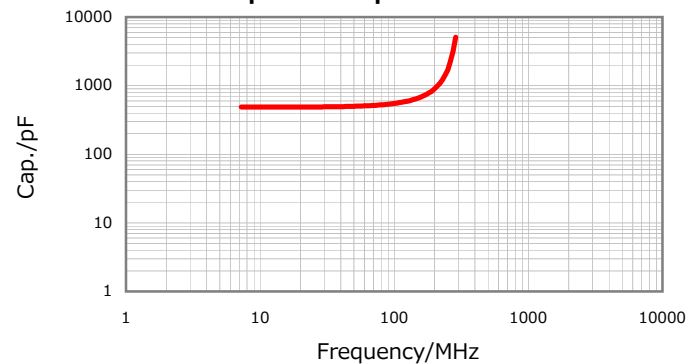

Temperature Characteristics



Characterization Sheet (Multilayer Ceramic Chip Capacitors)



All specifications are subject to change without notice.

January 3, 2016