

Features

25 A modular contactor - 2 pole

- 17.5 mm wide
- NO contact gap ≥ 3 mm, double break
- Continuous duty for the coil and contacts
- AC/DC silent coil (with varistor protection)
- Protective separation (reinforced insulation) between coil and contacts
- Mechanical and LED indicators as standard
- Auto-On-Off selector version available
- AgNi and AgSnO₂ contact versions available
- Compliant with EN 61095: 2009
- Auxiliary contact module available, quick-assembly with the main contactor (1 NO + 1 NC and 2 NO versions)
- 35 mm rail (EN 60715) mount

22.32...1xx0 / 22.32...4xx0
Screw terminal



* Contact gap ≥ 3 mm for NO contacts only;
NC contacts ≥ 1.5 mm
For outline drawings see page 8

22.32.0.xxx.1xx0



- AgNi contacts, specifically intended for resistive and slightly inductive loads as well as for motor loads

22.32.0.xxx.4xx0



- AgSnO₂ contacts, specifically intended for lamp loads and for high inrush current loads

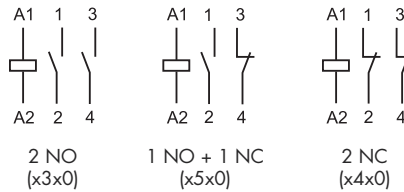

Contact specification

Contact configuration	2 NO, 3 mm * (or 1 NO + 1 NC or 2 NC)	
Rated current/Maximum peak current	A	25 / 80
Rated voltage	V AC	250 / 440
Rated load AC1 / AC-7a (per pole @ 250 V)	VA	6,250
Rated current AC3 / AC-7b	A	10
Rated load AC15 (per pole @ 230 V)	VA	1,800
Single-phase motor rating (230 V AC)	kW	1
Rated current AC-7c	A	—
230 V lamps rating: incandescent or halogen	W	—
compact fluorescent (CFL)	W	200
electronic ballast fluorescent tubes	W	800
electromagnetic ballast compens. fluorescent tubes	W	500
Breaking capacity DC1: 30/110/220 V	A	25/5/1
Minimum switching load	mW (V/mA)	1,000 (10/10)
Contact material		AgNi AgSnO ₂

Coil specification

Nominal voltage (U _N)	V DC/AC (50/60 Hz)	12 - 24 - 48 - 60 - 120 - 230	12 - 24 - 48 - 60 - 120 - 230
Rated power AC/DC	VA [50 Hz]/W	2 / 2.2	2 / 2.2
Operating range	DC/AC (50/60 Hz)	(0.8...1.1) U _N	(0.8...1.1) U _N
Holding voltage	DC/AC (50/60 Hz)	0.4 U _N	0.4 U _N
Must drop-out voltage	DC/AC (50/60 Hz)	0.1 U _N	0.1 U _N

Technical data

Mechanical life AC/DC	cycles	2 · 10 ⁶	2 · 10 ⁶
Electrical life at rated load AC-7a	cycles	70 · 10 ³	30 · 10 ³
Operate/release time	ms	30 / 20	30 / 20
Insulation between coil and contacts (1.2/50 μs)	kV	6	6
Ambient temperature range	°C	-20...+50	-20...+50
Protection category		IP20	IP20

Approvals (according to type)



Features

25 A modular contactor - 4 pole

- 35 mm wide
- NO contact gap ≥ 3 mm, double break
- Continuous duty for the coil and contacts
- AC/DC silent coil (with varistor protection)
- Protective separation (reinforced insulation) between coil and contacts
- Mechanical and LED indicators as standard
- Auto-On-Off selector version available
- AgNi and AgSnO₂ contact versions available
- Compliant with EN 61095: 2009
- Auxiliary contact module available, quick-assembly with the main contactor (1 NO + 1 NC and 2 NO versions)
- 35 mm rail (EN 60715) mount

22.34...1xx0 / 22.34...4xx0
Screw terminal



* Contact gap ≥ 3 mm for NO contacts only;
NC contacts ≥ 1.5 mm
For outline drawings see page 8

Contact specification

Contact configuration	4 NO, 3 mm * (or 3NO + 1NC or 2NO + 2NC)	
Rated current/Maximum peak current	A	25 / 80
Rated voltage	V AC	250 / 440
Rated load AC1 / AC-7a (per pole @ 250 V)	VA	6,250
Rated current AC3 / AC-7b	A	10
Rated load AC15 (per pole @ 230 V)	VA	1,800
Three-phase motor rating (400 - 440 V AC)	kW	4
Rated current AC-7c	A	—
230 V lamps rating: incandescent or halogen	W	2,000
compact fluorescent (CFL)	W	200
electronic ballast fluorescent tubes	W	800
electromagnetic ballast compens. fluorescent tubes	W	500
Breaking capacity DC1: 30/110/220 V	A	25/5/1
Minimum switching load	mW (V/mA)	1,000 (10/10)
Contact material		AgNi

Coil specification

Nominal voltage (U _N)	V DC/AC (50/60 Hz)	12 - 24 - 48 - 60 - 120 - 230	12 - 24 - 48 - 60 - 120 - 230
Rated power AC/DC	VA (50 Hz)/W	2 / 2.2	2 / 2.2
Operating range	DC/AC (50/60 Hz)	(0.8...1.1) U _N	(0.8...1.1) U _N
Holding voltage	DC/AC (50/60 Hz)	0.4 U _N	0.4 U _N
Must drop-out voltage	DC/AC (50/60 Hz)	0.1 U _N	0.1 U _N

Technical data

Mechanical life AC/DC	cycles	2 · 10 ⁶	2 · 10 ⁶
Electrical life at rated load AC-7a	cycles	150 · 10 ³	30 · 10 ³
Operate/release time	ms	18 / 40	18 / 40
Insulation between coil and contacts (1.2/50 μs)	kV	6	6
Ambient temperature range	°C	-20...+50	-20...+50
Protection category		IP20	IP20

Approvals (according to type)



22.34.0.xxx.1xx0



- AgNi contacts, specifically intended for resistive and slightly inductive loads as well as for motor loads

22.34.0.xxx.4xx0



- AgSnO₂ contacts, specifically intended for lamp loads and for high inrush current loads

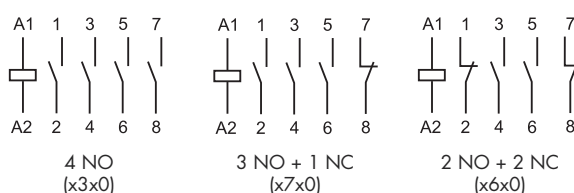

Features

40 - 63 A modular contactor - 4 pole

- NO and NC contact gap ≥ 3 mm, double break
- Continuous duty for the coil and contacts
- AC/DC silent coil (with varistor protection)
- Protective separation (reinforced insulation) between coil and contacts
- Mechanical indicator as standard
- AgSnO₂ contacts
- Compliant with EN 61095: 2009 and with EN 60947-4-1: 2009
- 35 mm rail (EN 60715) mount

22.44.../22.64...
Screw terminal



For outline drawings see page 8

NEW 22.44.0.xxx.4xx0



- For high inrush current loads 176 A
- Contact material AgSnO₂

NEW 22.64.0.xxx.4xx0



- Specifically intended for high inrush current loads 240 A
- Contact material AgSnO₂

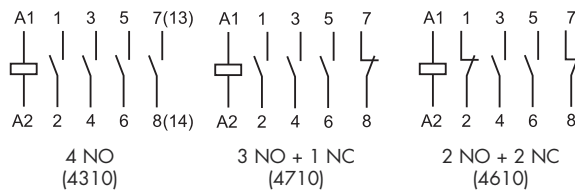

Contact specification			
Contact configuration		4 NO, (or 3NO + 1NC or 2NO + 2NC) ≥ 3 mm	
Rated current/Maximum peak current	A	40 / 176	63 / 240
Rated voltage	V AC	250 / 440	250 / 440
Rated load AC1 / AC-7a (per pole @ 250 V)	VA	16,000	24,000
Rated current AC3 / AC-7b (400 V)	A	22	30
Rated load AC15 (per pole @ 230 V)	VA	—	—
Three-phase motor rating (400 - 440 V AC)	kW	11	15
Rated current AC-7c	A	—	—
230 V lamps rating: incandescent or halogen	W	4,000	5,000
compact fluorescent (CFL)	W	1,000	1,500
electronic ballast fluorescent tubes	W	1,500	2,000
electromagnetic ballast compens. fluorescent tubes	W	1,500	2,000
Breaking capacity DC1: 30/110/220 V	A	40/4/1.2	63/4/1.2
Minimum switching load	mW (V/mA)	1,000 (17/50)	1,000 (17/50)
Contact material		AgSnO ₂	AgSnO ₂
Coil specification			
Nominal voltage (U _N)	V DC/AC (50/60 Hz)	12 - 24 - 110...120 (110 V DC) - 230...240 (220 V DC)	
Rated power AC/DC	VA (50 Hz)/W	5	5
Operating range	DC/AC (50/60 Hz)	(0.85...1.1) U _N	(0.85...1.1) U _N
Holding voltage	DC/AC (50/60 Hz)	0.85 U _N	0.85 U _N
Must drop-out voltage	DC/AC (50/60 Hz)	0.2 U _N	0.2 U _N
Technical data			
Mechanical life AC/DC	cycles	3 · 10 ⁶	3 · 10 ⁶
Electrical life at rated load AC-7a	cycles	100 · 10 ³	100 · 10 ³
Operate/release time	ms	20 / 45	20 / 45
Insulation between coil and contacts (1.2/50 μ s)	kV	6	6
Ambient temperature range	°C	-5...+55	-5...+55
Protection category		IP20	IP20
Approvals (according to type)			

Ordering information

Example: 22 series, modular contactor 25 A, 4 NO contacts, coil 230 V AC/DC, AgSnO₂ contacts, Auto-On-Off selector + mechanical indicator + LED.



Series _____
Type _____
 3 = 25 A modular contactor range
 4 = 40 A modular contactor range
 6 = 63 A modular contactor range
Number of contacts _____
 2 = 2 pole
 4 = 4 pole
Coil version _____
 0 = AC (50/60 Hz)/DC
Coil rated voltage _____
 See coil specifications

D: Special versions
 0 = Standard
C: Options
 1 = Mechanical indicator
 2 = Mechanical indicator + LED
 4 = Auto-On-Off selector + mechanical indicator + LED
B: Contact circuit
 3 = All NO contacts
 4 = All NC contacts (22.32 only)
 5 = 1 NO + 1 NC
 6 = 2 NO + 2 NC
 7 = 3 NO + 1 NC
A: Contact material
 1 = AgNi
 4 = AgSnO₂

Selecting features and options: only combinations in the same row are possible.
 Preferred selections for best availability are shown in **bold**.

Type	Coil version	A	B	C	D
22.32	AC/DC	1 - 4	3 - 4 - 5	2 - 4	0
22.34	AC/DC	1 - 4	3 - 6 - 7	2 - 4	0
22.44	AC/DC	4	3 - 6 - 7	1	0
22.64	AC/DC	4	3 - 6 - 7	1	0

Options

Auto-On-Off selector + mechanical indicator + LED (xx40 option)

Type 22.32 / 22.34

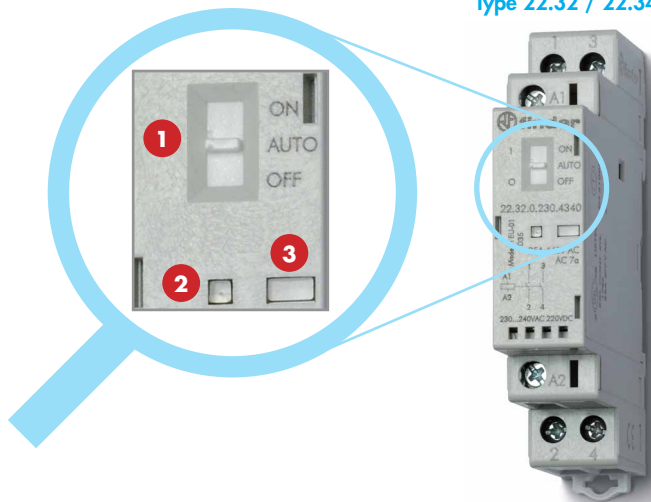

Options

- 1 Selector**
 The three-position manual selector has the following functions:
 - **ON position** - the contacts are latched in the operated state (NO contacts - closed and NC contacts - open), the mechanical indicator is visible in its window, the LED is not illuminated.
 - **AUTO position** - the state of contacts, mechanical indicator and LED follow the coil supply voltage.
 - **OFF position** - even if terminals A1 - A2 are supplied with rated voltage, the coil is not energized, and so the contacts remain in the non-operated state, the mechanical indicator is not visible and the LED is not illuminated.
- 2 LED**
- 3 Mechanical indicator**

Type 22.44 / 22.64

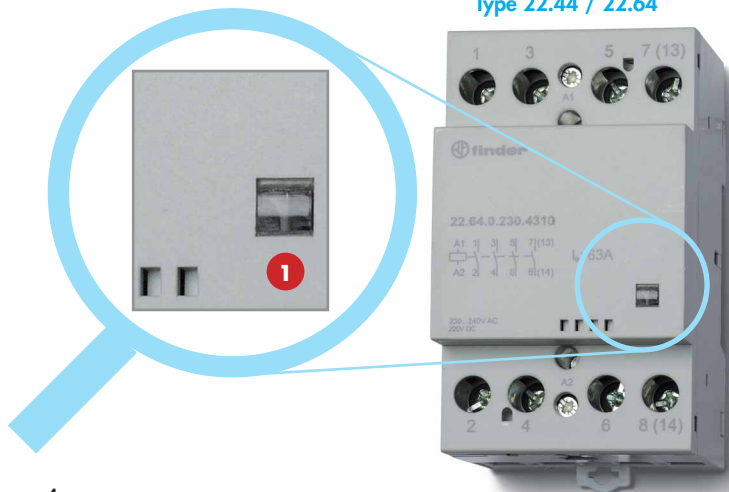

Options

mechanical indicator

Technical data

Insulation		22.32 / 22.34		22.44 / 22.64	
Rated insulation voltage	V AC	250	440	440	
Pollution degree		3 *	2	3	
Insulation between coil and contact set					
Type of insulation		Reinforced		Reinforced	
Overvoltage category		III		III	
Rated impulse voltage	kV (1.2/50 µs)	6		4	
Dielectric strength	V AC	4,000		2,000	
Insulation between adjacent contacts					
Type of insulation		Basic		Basic	
Overvoltage category		III		III	
Rated impulse voltage	kV (1.2/50 µs)	4		4	
Dielectric strength	V AC	2,500		2,000	
Insulation between open contacts		NO contact	NC contact	NO/NC contacts	
Contact gap	mm	3	1.5	3	
Overvoltage category		III	II	III	
Rated impulse voltage	kV (1.2/50 µs)	4	2.5	4	
Dielectric strength	V AC/kV (1.2/50 µs)	2,500/4	2,000/3	2,000/3	
* Only for versions without Auto-On-Off selector. For versions with Auto-On-Off selector pollution degree 2 applies.					
Conducted disturbance immunity		Reference standard			
Fast transients (burst 5/50 ns, 5 kHz) at coil terminals		EN 61000-4-4	Level 4 (4 kV)	Level 2 (2 kV)	
Voltage pulses (surge 1.2/50 µs) at supply terminals (differential mode)		EN 61000-4-5	Level 4 (4 kV)	Level 2 (2 kV)	
Short circuit protection		22.32 / 22.34	22.44	22.64	
Rated conditional short circuit current	kA	3	3	3	
Back-up fuse	A	32 (gL/gG type)	63	80	
Terminals		Solid and stranded cable			
		22.32 / 22.34	22.44 / 22.64		
Max. wire size – contact terminals	mm ²	1 x 6 / 2 x 4		1x25 (solid) - 1x16 (stranded)	
	AWG	1 x 10 / 2 x 12		1x4 (solid) - 1x6 (stranded)	
Max. wire size – coil terminals	mm ²	1 x 4 / 2 x 2.5		1x2.5	
	AWG	1 x 12 / 2 x 14		1x14	
Min. wire size – contact and coil terminals	mm ²	1 x 0.2		1x1 (coil) - 1x1.5 (contacts)	
	AWG	1 x 24		1x18 (coil) - 1x16 (contacts)	
 Screw torque	Nm	0.8		1.2 (coil terminals) - 3.5 (contact terminals)	
Wire strip length	mm	9		10	
Power lost to the environment		22.32	22.34	22.44	22.64
	without contact current W	2	2	5	5
	with rated current W	4.8	6.3	17	37

NOTE

22.32/22.34: It is suggested an air gap of 9 mm between adjacent relays for installations and working conditions close to the limit (that is, ambient temperature > 40 °C, coil operated for a prolonged period of time, all contacts loaded with current > 20 A).

22.44/22.64: The maximum ambient temperature with 3 adjacent contactors is + 40 °C; when more than 3 contactors are installed, it is necessary an air gap of 9 mm.
With 2 adjacent contactors the maximum ambient temperature is + 55 °C; when more than 2 contactors are installed, it is necessary an air gap of 9 mm.

Contact specification

Ratings and utilization categories according to EN 61095: 2009

Type	Utilization category					
	AC-7a		AC-7b		AC-7c	
	Rated current (A)	Rated electrical life (Cycles)	Rated current (A)	Rated electrical life (Cycles)	Rated current (A)	Rated electrical life (Cycles)
22.32....1xx0 (AgNi contacts)	25	70·10 ³ (NO)	10	30·10 ³	—	—
		30·10 ³ (NC)				
22.32....4xx0 (AgSnO ₂ contacts)	25	30·10 ³	10	30·10 ³	10	30·10 ³
22.34....1xx0 (AgNi contacts)	25	150·10 ³ (NO)	10	30·10 ³	—	—
		100·10 ³ (NC)				
22.34....4xx0 (AgSnO ₂ contacts)	25	30·10 ³	10	30·10 ³	10	30·10 ³
22.44....4xx0	40	100·10 ³	22	150·10 ³	—	—
22.64....4xx0	63	100·10 ³	30	150·10 ³	—	—

Utilization category: **AC-7a** = Slightly inductive loads (cosφ=0.8)
AC-7b = Motor loads; (cosφ=0.45, I_{making}= 6xI_{breaking})
AC-7c = Compensated electric discharge lamps (cosφ=0.9, C= 10 mF/A)

H 22 - Maximum DC1 breaking capacity - Type 22.32 / 22.34

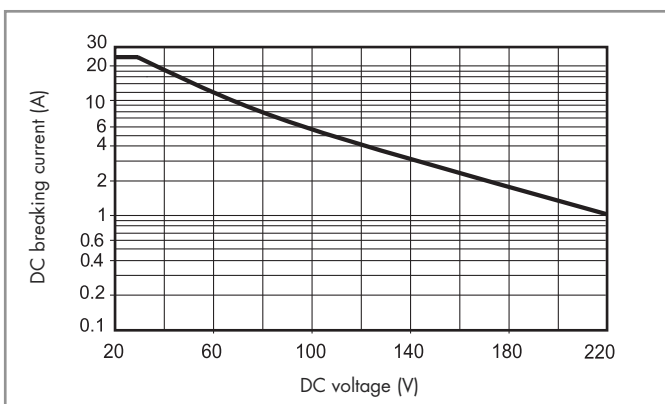

H 22 - Maximum DC1 breaking capacity - Type 22.44 / 22.64

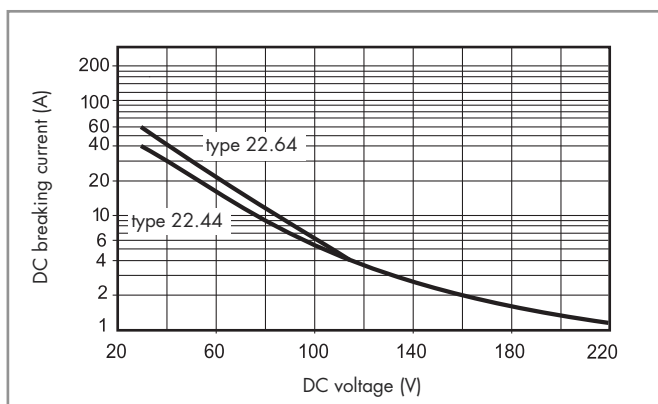

- When switching a resistive load (DC1) having voltage and current values under the curve, an electrical life of ≥ 100·10³ can be expected.
 - In the case of DC13 loads, the connection of a diode in parallel with the load will permit a similar electrical life as for a DC1 load.
- Note: the release time for the load will be increased.

Coil specifications

AC/DC version data (type 22.32)

Nominal voltage U _N	Coil code	Operating range		Rated coil consumption I _N at U _N (AC)
		U _{min}	U _{max}	
V		V	V	mA
12	0.012	9.6	13.2	165
24	0.024	19.2	26.4	83
48	0.048	38.4	52.8	42
60	0.060	48	66	33
120	0.120	88	138	16.5
(110...125)				
230	0.230	184 (AC)	264 (AC)	8.7
(230...240 AC) (220 DC)		176 (DC)	242 (DC)	

AC/DC version data (type 22.34)

Nominal voltage U _N	Coil code	Operating range		Rated coil consumption I _N at U _N (AC)
		U _{min}	U _{max}	
V		V	V	mA
12	0.012	9.6	13.2	165
24	0.024	19.2	26.4	83
48	0.048	38.4	52.8	42
60	0.060	48	66	33
120	0.120	88	138	16.5
(110...125)				
230	0.230	184 (AC)	264 (AC)	8.7
(230...240 AC) (220 DC)		176 (DC)	242 (DC)	

AC/DC version data (type 22.44 / 22.64)

Nominal voltage U _N	Coil code	Operating range		Rated coil consumption I _N at U _N (AC)
		U _{min}	U _{max}	
V		V	V	mA
12	0.012	10.2	13.2	417
24	0.024	20.4	26.4	208
120	0.120	102	138	41
(110...125)				
230	0.230	196	264 (AC)	21
(230...240 AC) (220 DC)		196	242 (DC)	

R 22 - Coil operating range v ambient temperature

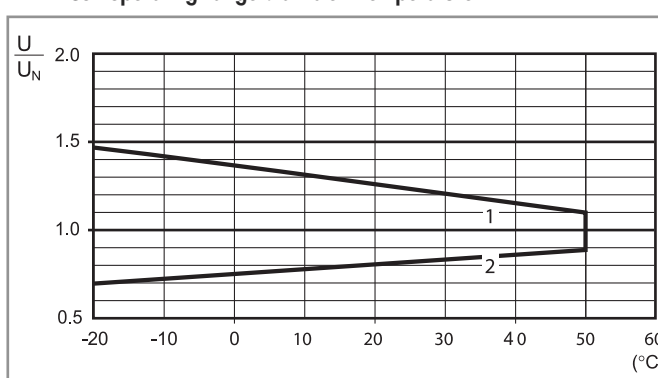

- 1 - Max. permitted coil voltage.
 2 - Min. pick-up voltage with coil at ambient temperature.

Wiring diagrams

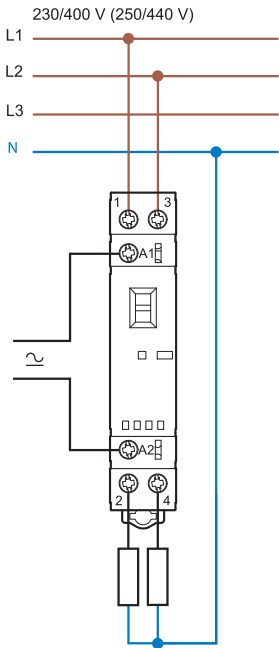

Type 22.32

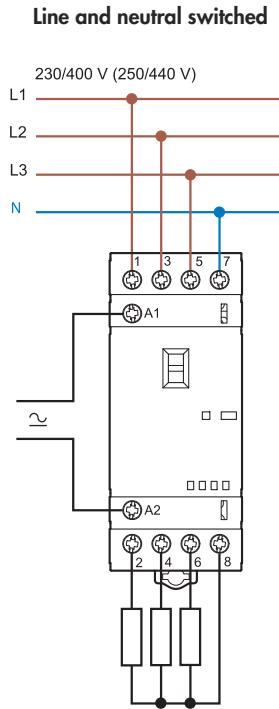

Type 22.34

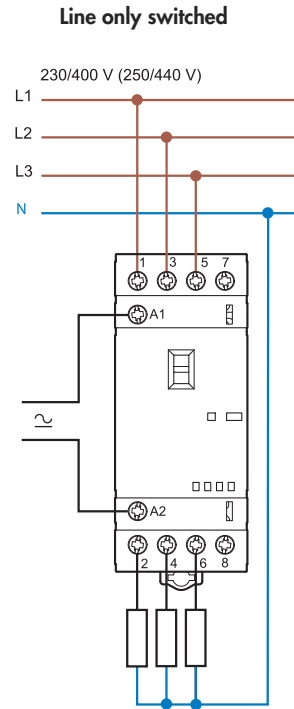

Type 22.34

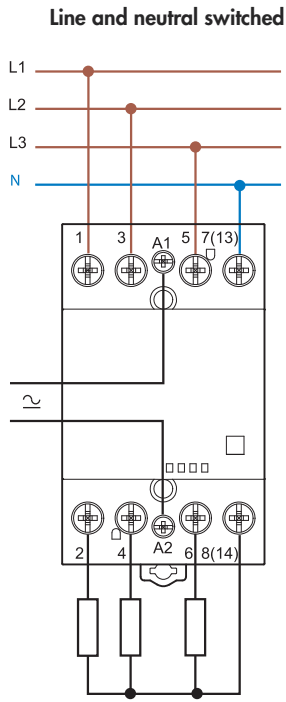

Type 22.44 / 22.64

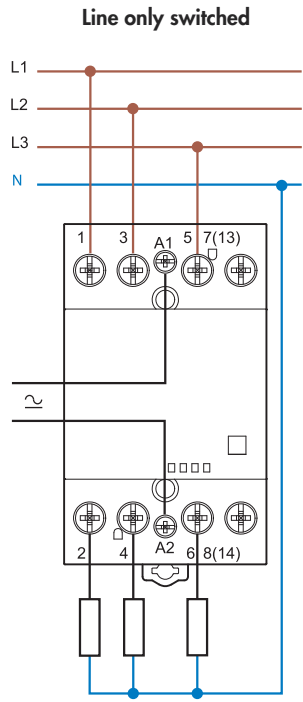

Type 22.44 / 22.64

Outline drawings

Type 22.32
Screw terminal

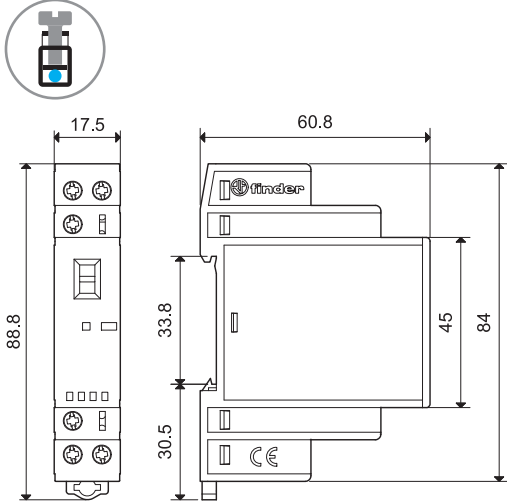

Type 22.32 + 022.33 / 022.35
Screw terminal

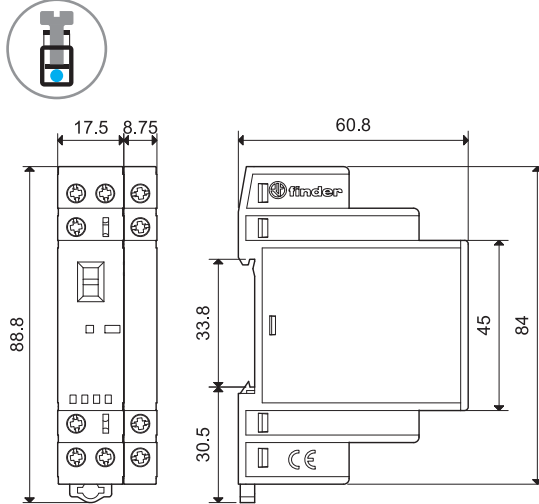

Type 22.34
Screw terminal

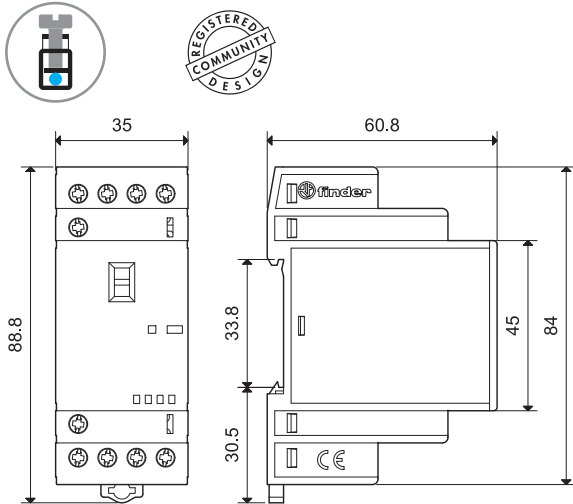

Type 22.34 + 022.33 / 022.35
Screw terminal

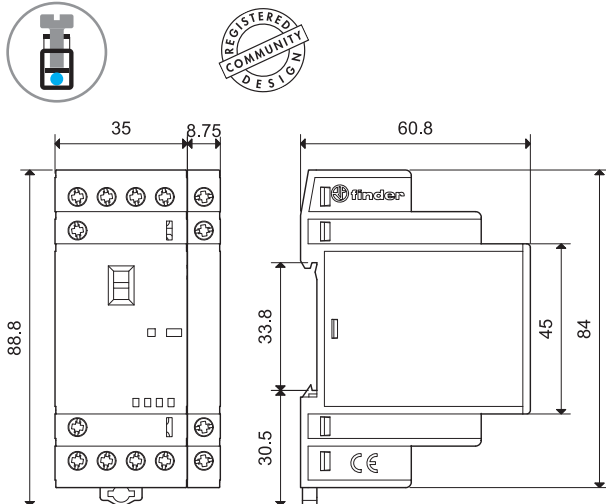

Type 022.33 / 022.35
Screw terminal

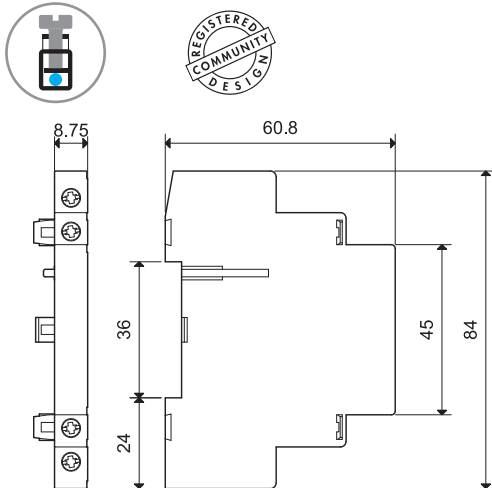

Type 22.44 / 22.64
Screw terminal

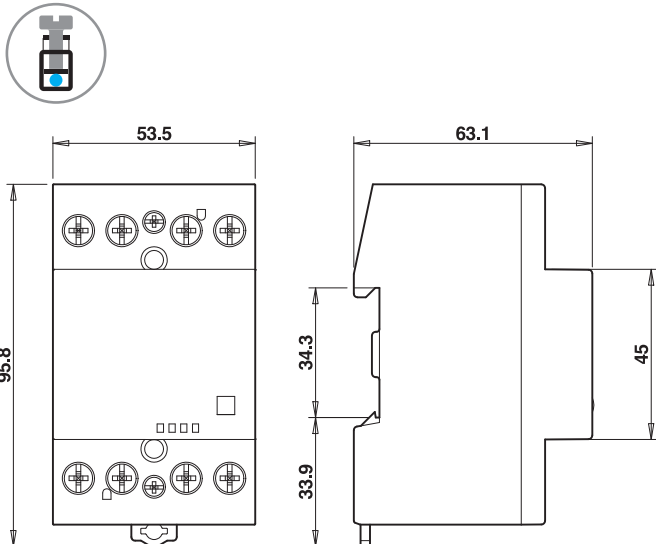

**Auxiliary module 022.33 / 022.35
for 22.32 and 22.34 only**



22.32 + 022.33 / 022.35



22.34 + 022.33 / 022.35

022.33



022.35



Contact specification			
Contact configuration		2 NO	1 NO + 1 NC
Conventional free air thermal current I_{th}	A	6	6
Rated current AC15 (230 V)	VA	700	700
Electrical life at rated load	cycles	30×10^3	30×10^3
Contact material		AgNi	AgNi
Short circuit protection			
Rated conditional short circuit current	kA	1	
Back-up fuse	A	6 (gL/gG type)	
Terminals		Solid and stranded cable	
Max. wire size	mm ²	1 x 4 / 2 x 2.5	
	AWG	1 x 12 / 2 x 14	
Min. wire size	mm ²	1 x 0.2	
	AWG	1 x 24	
⊕ Screw torque	Nm	0.8	
Wire strip length	mm	9	
Power lost to the environment			
without contact current	W	—	
with rated current	W	0.5	
Approvals (according to type)			

NOTE: it is not possible to assembly the auxiliary module on 22.32.0.xxx.x4x0 (2 NC versions).

Accessories



020.01

Adaptor for panel mounting (for 22.32 type), plastic, 17.5 mm wide

020.01

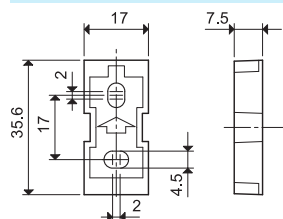

011.01

Adaptor for panel mounting (for 22.34 type), plastic, 35 mm wide

011.01

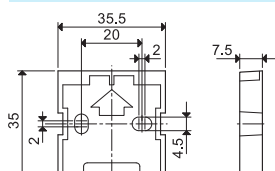

060.72

Sheet of marker tags, plastic, 72 tags, 6x12 mm

060.72



019.01

Identification tag, plastic, 1 tag, 17x25.5 mm

019.01



020.03

Separator for rail mounting, plastic, 3 mm wide

020.03

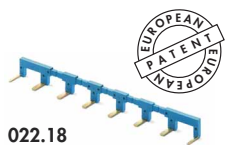
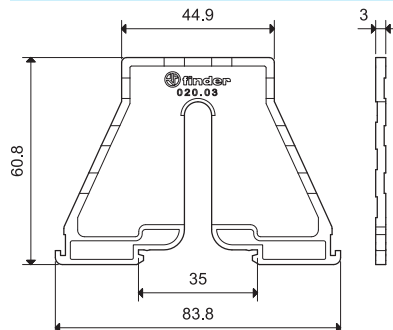

022.18

8-way jumper link for types 22.32, 17.5 mm wide

022.18 (blue)

Rated values

10 A - 250 V

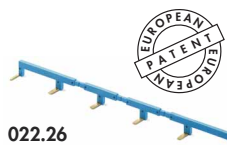
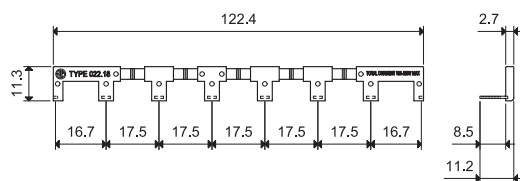

022.26

6-way jumper link for types 22.34, 35 mm wide

022.26 (blue)

Rated values

10 A - 250 V

