

# Magnecraft® Printed Circuit Board & Reed Relays

Catalog  
2010

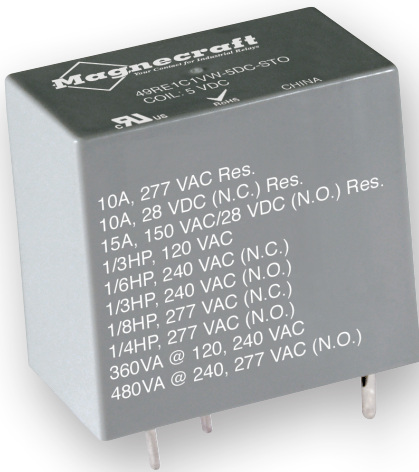
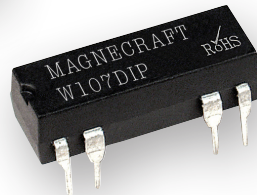
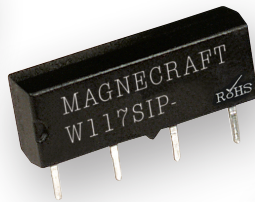
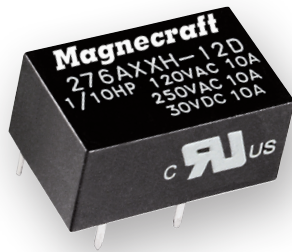

---

■ Series Overview . . . . .	3
■ 117SIP Relays . . . . .	4
■ 107DIP Relays . . . . .	7
■ 171DIP Relays . . . . .	10
■ 172DIP Relays . . . . .	13
■ 49 Series Relays . . . . .	16
■ 276 Series Relays . . . . .	19
■ 976 Series Relays . . . . .	22
■ Application Data . . . . .	25
■ Selection Guide . . . . .	27
■ Website Guide . . . . .	28

Built in small industry-standard packages, the Magnecraft line of printed circuit board (PCB) relays is ideal for a variety of applications.

## Key Features

- Space-saving package design
- Single and double pole switching
- Ratings range from 0.25 to 20 A
- Sealed for wash-down process
- Wave solderable



117SIP



107DIP



171DIP



172DIP



49



276



976

Series	Style	Contact Configuration	Output Current Range (A)	Output Voltage Range	Minimum Switching Requirement (mA)	Response Time (ms)	Page
117SIP	Miniature reed relay	SPST	0.25–0.35	120 Vac, 200 Vdc	10	0.45	4
107DIP	Miniature reed relay	SPST	0.25–0.35	120 Vac, 100 Vdc	10	1	7
171DIP	Miniature reed relay	SPST; DPST	0.25–0.35	60–120 Vac, 100 Vdc	10	1	10
172DIP	Miniature reed relay	SPDT; DPDT	0.25–0.35	60 Vac, 100 Vdc	10	1	13
49	Electromechanical relay	SPDT	3–10	120–277 Vac, 28 Vdc	100	25	16
276	Electromechanical relay	SPST; SPDT	7–10	240 Vac, 30 Vdc	100	10	19
976	Electromechanical relay	SPST; DPDT	5–20	240 Vac, 30–48 Vdc	100	10	22

## Description

# Magnecraft® PCB & Reed Relays

117SIP

SPST, 0.35 A (AC); 0.25 A (DC)

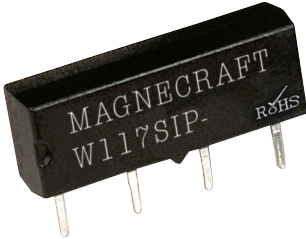

117SIP

## Description

The 117SIP reed relays are uniquely designed in a standard style in-line package capable of switching up to 0.35 A (AC); 0.25 A (DC).

Feature	Benefit
Small size	Saves space on a PC board
High shock resistance (50 g-n)	Helps avoid damage in harsh conditions
Industry standard pin spacing	Designed for simple routing on PC board
Can withstand a lead-free solder reflow process	Meets industry standards
RoHS Compliant	Meets industry standards for RoHS compliant reflow processes

Rated Output Current	Contact Configuration	Input Voltage (Vdc)	Coil Resistance (Ω)	Wiring Diagram	Standard Part Number
0.35 A (AC); 0.25 A (DC)	SPST-NO	5	500	A	117SIP-1
		12	1000	A	117SIP-3
	SPST-NC	5	500	B	117SIP-22
	SPST-NO w/clamping diode	5	500	C	117SIP-6
	SPST-NC w/clamping diode	5	500	D	117SIP-18

## Part Number Explanation

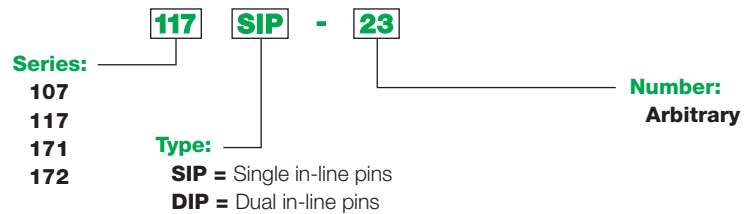

Specifications (UL 508)

Part Number 117SIP	Specifications
<b>Input Characteristics</b>	
Input Voltage Range	5–24 Vdc
Operating Range (% of Nominal)	80%–110%
Average Power Consumption	0.29 W
Drop-out Voltage Threshold	10%
<b>Output Characteristics</b>	
Contact Configuration	SPST-NO; SPST-NC
Contact Materials	Ruthenium
Output Current Load	0.35 A (AC); 0.25 A (DC)
Output Voltage Range	120 Vac; 200 Vdc
Output Load Wattage	10 W
Minimum Switching Requirement	1 mA
<b>General Characteristics</b>	
Electrical Life (Operations at rated current)	200,000 operations
Mechanical Life (Unpowered)	1,000,000,000 operations
Operating Time (Response time)	1 ms
Dielectric Strength (Between coil and contact)	500 V(rms)
Dielectric Strength (Between poles)	500 V(rms)
Dielectric Strength (Between contacts)	200 V(rms)
Storage Temperature Range	-40–105 °C (-40–221 °F)
Operating Temperature Range	-40–85 °C (-40–185 °F)
Vibration Resistance (Operational)	20 g-n, 10–2000 Hz
Shock Resistance	50 g-n
Weight	1 g (0.035 oz)
Agency Approvals	RoHS

Dimensions: Inches (Millimeters)

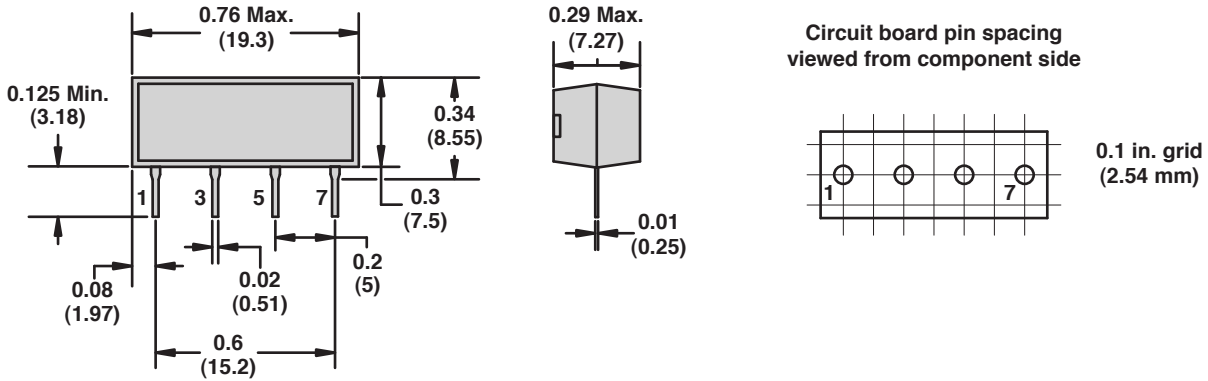

Wiring Diagrams

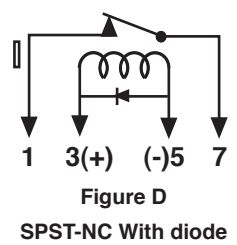
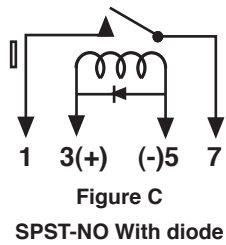
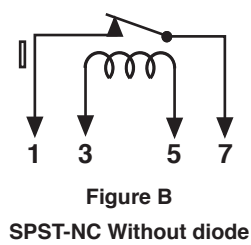
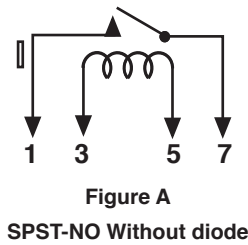

## Description

# Magnecraft® PCB & Reed Relays

107DIP

SPST-NO, 0.35 A (AC); 0.25 A (DC)

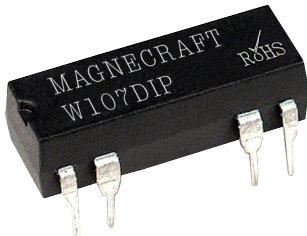

107DIP

## Description

The 107DIP reed relays are uniquely designed in a standard style dual in-line package capable of switching up to 0.35 A (AC); 0.25 A (DC).

Feature	Benefit
Small size	Saves space on a PC board
High shock resistance (50 g-n)	Helps avoid damage in harsh conditions
Industry standard pin spacing	Designed for simple routing on PC board
Can withstand a lead-free solder reflow process	Meets industry standards
RoHS Compliant	Meets industry standards for RoHS compliant reflow processes

Rated Output Current	Contact Configuration	Input Voltage (Vdc)	Coil Resistance (Ω)	Wiring Diagram	Standard Part Number
0.35 A (AC); 0.25 A (DC)	SPST-NO	5	500	E	107DIP-1
		12	1000	E	107DIP-3
	SPST-NO w/clamping diode	5	500	F	107DIP-5
		12	1000	F	107DIP-7

## Part Number Explanation

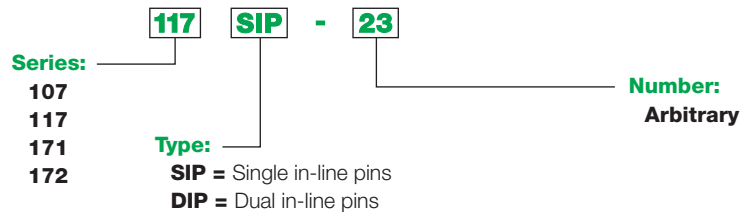

Specifications (UL 508)

Part Number 107DIP	Specifications
<b>Input Characteristics</b>	
Input Voltage Range	5–24 Vdc
Operating Range (% of Nominal)	80%–110%
Average Power Consumption	0.29 W
Drop-out Voltage Threshold	10%
<b>Output Characteristics</b>	
Contact Configuration	SPST-NO
Contact Materials	Ruthenium
Output Current Load	0.35 A (AC); 0.25 A (DC)
Output Voltage Range	120 Vac; 100 Vdc
Output Load Wattage	10 W
Minimum Switching Requirement	1 mA
<b>General Characteristics</b>	
Electrical Life (Operations at rated current)	200,000 operations
Mechanical Life (Unpowered)	1,000,000,000 operations
Operating Time (Response time)	1 ms
Dielectric Strength (Between coil and contact)	1000 V(rms)
Dielectric Strength (Between poles)	1000 V(rms)
Dielectric Strength (Between contacts)	200 V(rms)
Storage Temperature Range	-40–105 °C (-40–221 °F)
Operating Temperature Range	-40–85 °C (-40–185 °F)
Vibration Resistance (Operational)	20 g-n, 10–2000 Hz
Shock Resistance	50 g-n
Weight	1 g (0.035 oz)
Agency Approvals	RoHS



**Dimensions: Inches (Millimeters)**

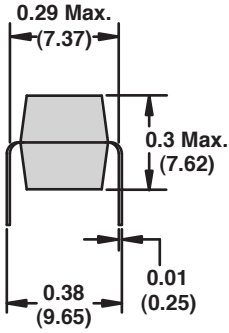
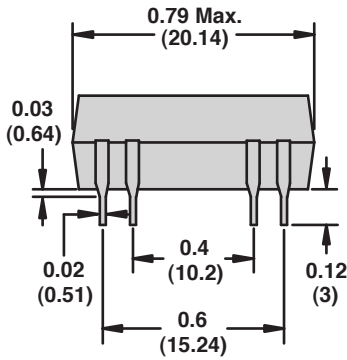

Circuit board pin spacing  
viewed from component side

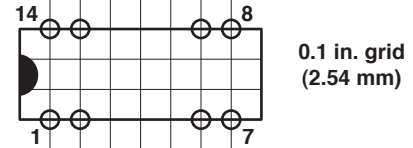

**Wiring Diagrams**

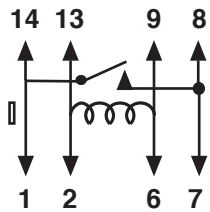

Figure E  
SPST-NO Without diode

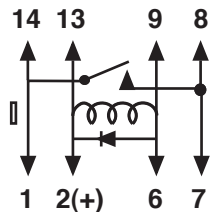

Figure F  
SPST-NO With diode

## Description

# Magnecraft® PCB & Reed Relays

171DIP

SPST, 0.35 A (AC); 0.25 A (DC)

DPST-NO, 0.35 A (AC); 0.25 A (DC)

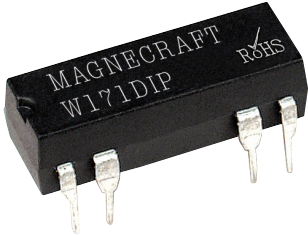

171DIP

## Description

The 171DIP reed relays are uniquely designed in a standard style dual in-line package capable of switching up to 0.35 A (AC); 0.25 A (DC).

Feature	Benefit
Small size	Saves space on a PC board
High shock resistance (50 g-n)	Helps avoid damage in harsh conditions
Industry standard pin spacing	Designed for simple routing on PC board
Can withstand a lead-free solder reflow process	Meets industry standards
RoHS Compliant	Meets industry standards for RoHS compliant reflow processes

Rated Output Current	Contact Configuration	Input Voltage (Vdc)	Coil Resistance ( $\Omega$ )	Wiring Diagram	Standard Part Number
0.35 A (AC); 0.25 A (DC)	SPST-NO	5	500	G	171DIP-2
		12	1000	G	171DIP-4
	SPST-NO w/clamping diode	5	500	H	171DIP-7
		24	2200	H	171DIP-10
	SPST-NC	5	500	I	171DIP-12
		12	1000	I	171DIP-14
	SPST-NC w/clamping diode	5	500	J	171DIP-17
	DPST-NO	5	200	K	171DIP-21
		12	500	K	171DIP-23
	DPST-NO w/clamping diode	5	200	L	171DIP-25
		12	500	L	171DIP-27
			24	2200	L

## Part Number Explanation

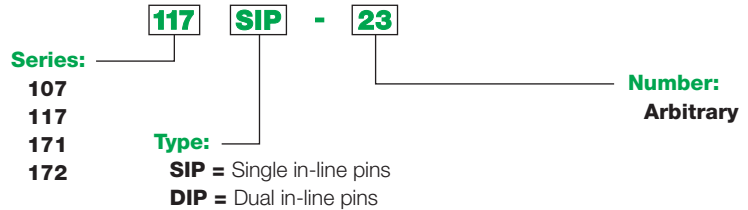

### Specifications (UL 508)

Part Number 171DIP	Specifications
<b>Input Characteristics</b>	
Input Voltage Range	5–24 Vdc
Operating Range (% of Nominal)	80%–110%
Average Power Consumption	0.29 W
Drop-out Voltage Threshold	10%
<b>Output Characteristics</b>	
Contact Configuration	SPST-NO; SPST-NC; DPST-NO
Contact Materials	Ruthenium
Output Current Load	0.35 A (AC); 0.25 A (DC)
Output Voltage Range	60 Vac (SPST); 120 Vac (DPST); 100 Vdc
Output Load Wattage	10 W
Minimum Switching Requirement	1 mA
<b>General Characteristics</b>	
Electrical Life (Operations at rated current)	200,000 operations
Mechanical Life (Unpowered)	1,000,000,000 operations
Operating Time (Response time)	1 ms
Dielectric Strength (Between coil and contact)	1000 V(rms)
Dielectric Strength (Between poles)	1000 V(rms)
Dielectric Strength (Between contacts)	200 V(rms)
Storage Temperature Range	-40–105 °C (-40–221 °F)
Operating Temperature Range	-40–85 °C (-40–185 °F)
Vibration Resistance (Operational)	20 g-n, 10–2000 Hz
Shock Resistance	50 g-n
Weight	1 g (0.035 oz)
Agency Approvals	RoHS

Dimensions: Inches (Millimeters)

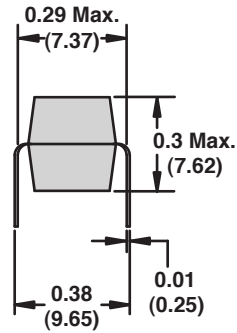
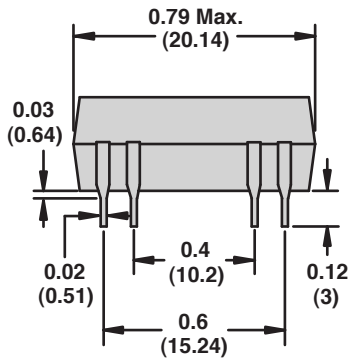

Circuit board pin spacing viewed from component side

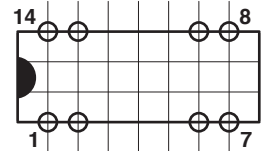

0.1 in. grid (2.54 mm)

Wiring Diagrams

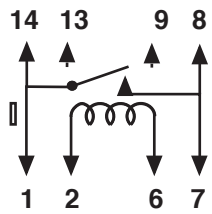

Figure G

SPST-NO Without diode

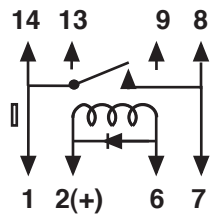

Figure H

SPST-NO With diode

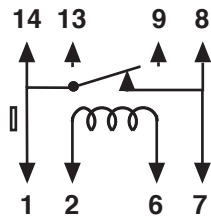

Figure I

SPST-NC Without diode

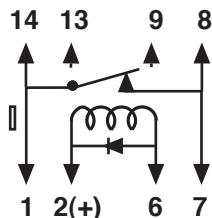

Figure J

SPST-NC With diode

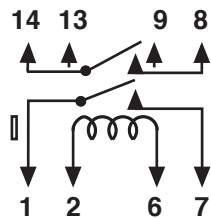

Figure K

DPST-NO Without diode

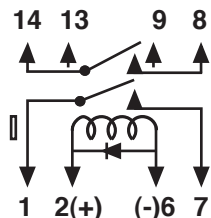

Figure L

DPST-NO With diode

## Description

# Magnecraft® PCB & Reed Relays

172DIP

SPDT, 0.35 A (AC); 0.25 A (DC)

DPDT, 0.35 A (AC); 0.25 A (DC)

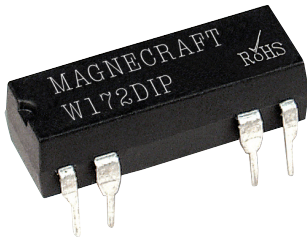

172DIP

## Description

The 172DIP reed relays are uniquely designed in a standard style dual in-line package capable of switching up to 0.35 A (AC); 0.25 A (DC).

Feature	Benefit
Small size	Saves space on a PC board
High shock resistance (50 g-n)	Helps avoid damage in harsh conditions
Industry standard pin spacing	Designed for simple routing on PC board
Can withstand a lead-free solder reflow process	Meets industry standards
RoHS Compliant	Meets industry standards for RoHS compliant reflow processes

Rated Output Current	Contact Configuration	Input Voltage (Vdc)	Coil Resistance (Ω)	Wiring Diagram	Standard Part Number
0.35 A (AC); 0.25 A (DC)	SPDT	5	200	M	172DIP-1
				O	172DIP-31
				P	172DIP-141
		12	1000	M	172DIP-3
				O	172DIP-33
				P	172DIP-145
	SPDT w/clamping diode	5	200	N	172DIP-5
				Q	172DIP-147
				N	172DIP-7
		12	1000	Q	172DIP-149
				N	172DIP-8
				Q	172DIP-150
DPDT	12	266	R	172DIP-19	
DPDT w/clamping diode	5	46	S	172DIP-21	
	12	266	S	172DIP-23	

### Part Number Explanation

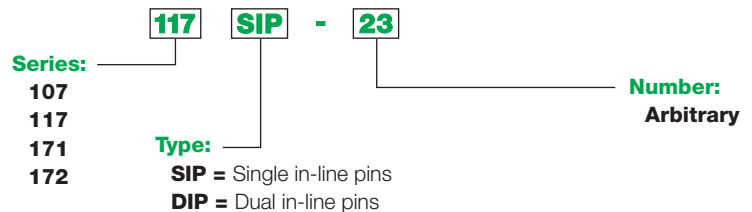

# Magnecraft® PCB & Reed Relays

172DIP

SPDT, 0.35 A (AC); 0.25 A (DC)

DPDT, 0.35 A (AC); 0.25 A (DC)

## Specifications (UL 508)

Part Number 172DIP	Specifications
<b>Input Characteristics</b>	
Input Voltage Range	5–24 Vdc
Operating Range (% of Nominal)	80%–110%
Average Power Consumption	0.29 W
Drop-out Voltage Threshold	10%
<b>Output Characteristics</b>	
Contact Configuration	SPDT; DPDT
Contact Materials	Ruthenium
Output Current Load	0.35 A (AC); 0.25 A (DC)
Output Voltage Range	60 Vac; 100 Vdc
Output Load Wattage	5 W
Minimum Switching Requirement	1 mA
<b>General Characteristics</b>	
Electrical Life (Operations at rated current)	200,000 operations
Mechanical Life (Unpowered)	1,000,000,000 operations
Operating Time (Response time)	1 ms
Dielectric Strength (Between coil and contact)	1000 V(rms)
Dielectric Strength (Between poles)	1000 V(rms)
Dielectric Strength (Between contacts)	150 V(rms)
Storage Temperature Range	-40–105 °C (-40–221 °F)
Operating Temperature Range	-40–85 °C (-40–185 °F)
Vibration Resistance (Operational)	20 g-n, 10–2000 Hz
Shock Resistance	50 g-n
Weight	1 g (0.035 oz)
Agency Approvals	RoHS

Dimensions: Inches (Millimeters)

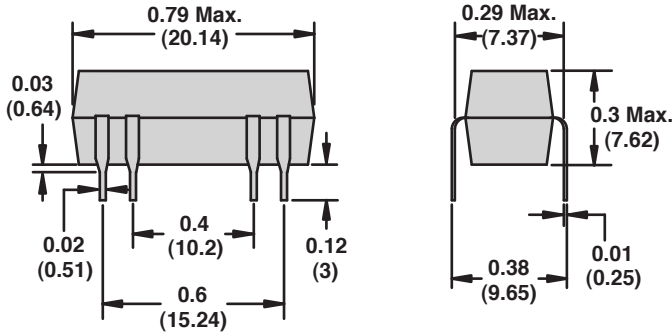

Circuit board pin spacing viewed from component side

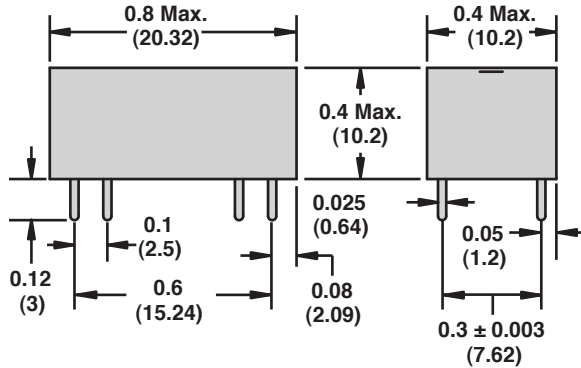
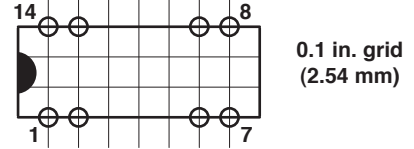

Wiring Diagrams

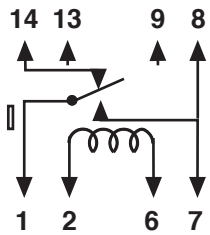

Figure M  
SPDT Without diode

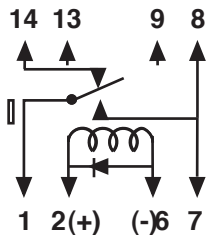

Figure N  
SPDT With diode

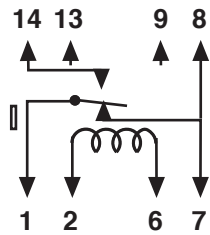

Figure O  
SPDT Without diode

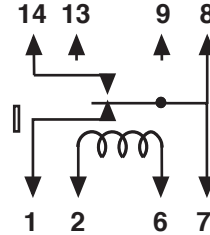

Figure P  
SPDT Without diode

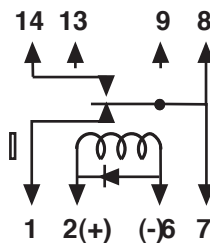

Figure Q  
With diode

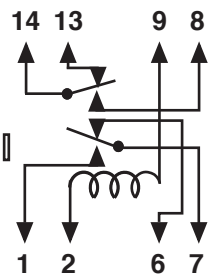

Figure R  
DPDT Without diode

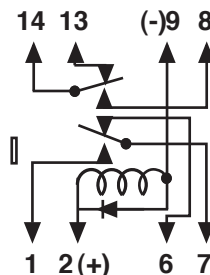
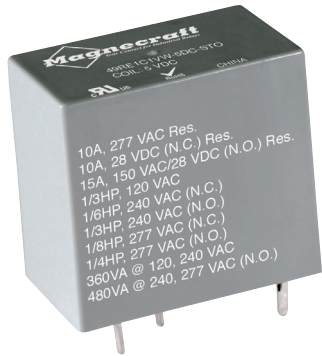

Figure S  
DPDT With diode



## Description

The 49 series enclosed printed circuit board relays are used to switch resistive and inductive loads in industrial applications.

Feature	Benefit
Small size	Enables relay to be used in smaller applications by saving space on PC board
Rated up to 10 A	Higher switching capacity expands range of potential applications
TV3 rating	Makes it ideal for appliance use
Tungsten, ballast and motor ratings (10 A version only)	Approved for use with inductive loads
Multiple footprint configurations	Fits a variety of applications and increases functionality and ease of use

49

Rated Output Current (A)	Contact Configuration	Input Voltage (Vdc)	Coil Resistance (Ω)	Style	Standard Part Number
3	SPDT	3	90	Narrow footprint	49RE1C1VG-3DC-SIL
		5	235	Narrow footprint	49RE1C1VG-5DC-SIL
		12	1350	Narrow footprint	49RE1C1VG-12DC-SIL
			1640	Wide footprint	49RE1C2VF-12DC-SIL
5	SPDT	5	235	Narrow footprint	49RE1C1VG-5DC-STO
		6	410	Wide footprint	49RE1C2VF-6DC-STO
		12	1350	Narrow footprint	49RE1C1VG-12DC-STO
		18	3000	Narrow footprint	49RE1C1VG-18DC-STO
		24	5400	Narrow footprint	49RE1C1VG-24DC-STO
10	SPDT	5	235	Narrow footprint with top mounting bracket	49R1C4VG-5DC-STO
		5	100	Narrow footprint	49RE1C1VW-5DC-STO
		12	600	Narrow footprint	49RE1C1VW-12DC-STO
		24	2400	Narrow footprint	49RE1C1VW-24DC-STO

### Part Number Explanation

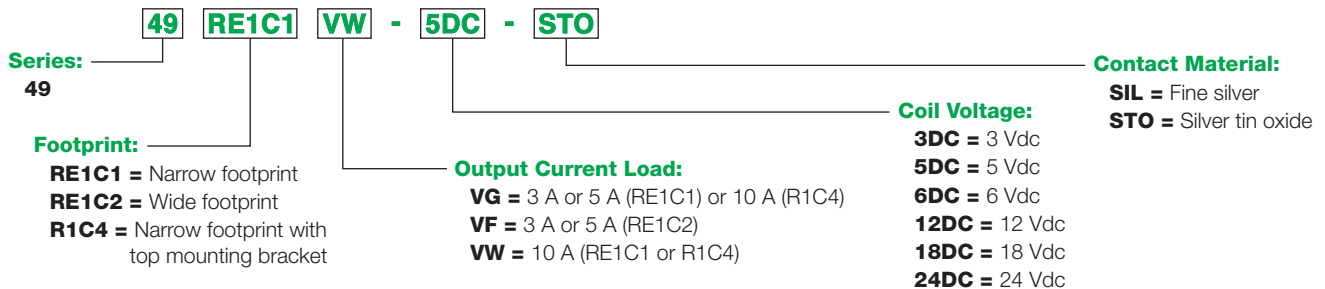



Specifications (UL 508)

Part Number	49 Relay 3 A	49 Relay 5 A	49 Relay 10 A	
<b>Input Characteristics</b>				
Input Voltage Range	NO: 3–24 Vdc; NC: 5–24 Vdc	3–24 Vdc		
Operating Range (% of Nominal)	75%–110%			
Average Power Consumption	0.11 W			
Drop-out Voltage Threshold	10%			
<b>Output Characteristics</b>				
Contact Configuration	SPDT			
Contact Materials	Fine Silver	Silver Tin Oxide		
Contact Ratings	General Purpose	3 A @ 120 Vac	5 A @ 120 Vac	10 A @ 240 Vac
	Resistive	NO: 15 A @ 150 Vac 50/60 Hz, 15 A @ 28 Vdc; NC: 3 A @ 28 Vdc	NO/NC: 5 A @ 28 Vdc	NO: 15 A @ 150 Vac 50/60 Hz, 15 A @ 28 Vdc; NC: 10 A @ 277 Vac 50/60 Hz, 10 A @ 28 Vdc
	Motor	N/A	N/A	NO: 1/3 hp @ 120/240 Vac, 1/4 hp @ 277 Vac; NC: 1/3 hp @ 120 Vac, 1/6 hp @ 240 Vac, 1/8 hp @ 277 Vac
	Tungsten	N/A	N/A	NC: 2 A @ 120 Vac
	Ballast	N/A	N/A	NO/NC: 1.7 A @ 277 Vac
	TV-3	N/A	N/A	120 Vac
	Pilot Duty	N/A	B300: 360 VA @ 120/240 Vac	B300: 360 VA @ 120/240 Vac; 480 VA @ 240/277 Vac (NO)
Minimum Switching Requirement	100 mA			
<b>General Characteristics</b>				
Electrical Life (Operations @ rated current)	100,000 operations			
Mechanical Life (Unpowered)	10,000,000 operations			
Response Time	25 ms			
Dielectric Strength (Between coil and contact)	2500 V(rms)	2500 V(rms)	1500 V(rms)	
Dielectric Strength (Between contacts)	500 V(rms)	500 V(rms)	500 V(rms)	
Storage Temperature Range	-40–85 °C (-40–185 °F)			
Operating Temperature Range	-40–55 °C (-40–131 °F)			
Vibration Resistance (Operational)	3 g-n, 10–55 Hz			
Shock Resistance	10 g-n			
Weight	42 g (1.48 oz)			
Available Footprint Styles	RE1C1 & RE1C2	RE1C1, RE1C2 & R1C4	RE1C1 & R1C4	
Agency Approvals	UR (E258297), RoHS			

Dimensions: Inches (Millimeters)

Narrow footprint style (RE1C1)

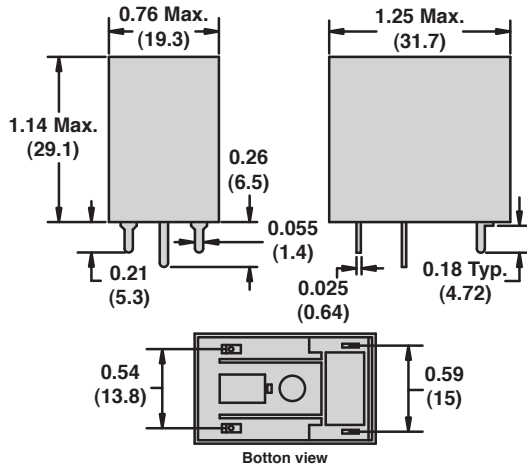

Wide footprint style (RE1C2)

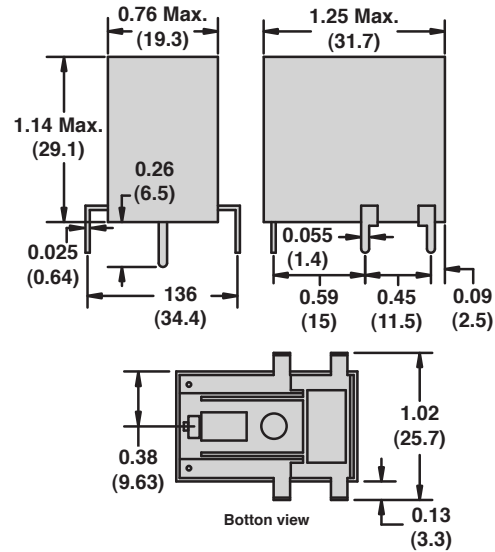

Top mounting bracket style (R1C4)

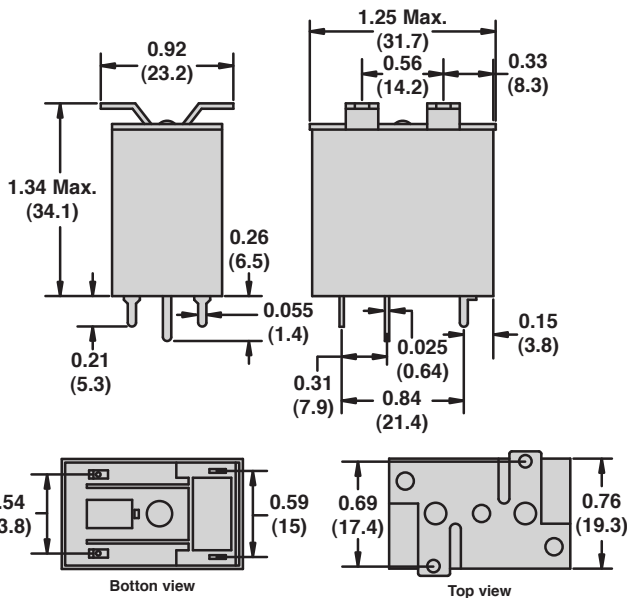

Circuit board pin spacing viewed from component side on PCB board

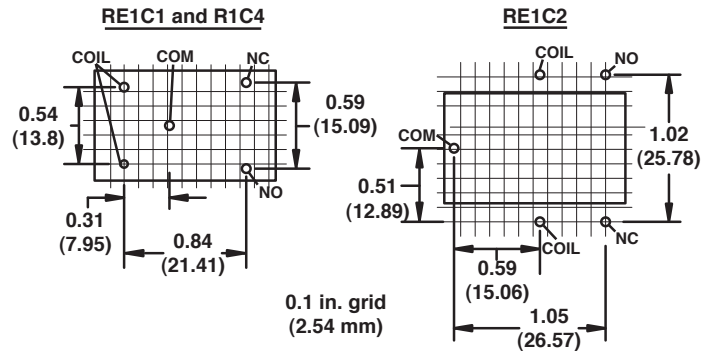

Wiring Diagrams

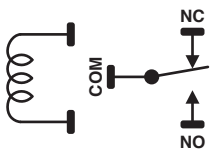

Style RE1C1 & R1C4

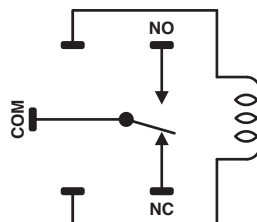

Style RE1C2

## Description

# Magnecraft® PCB & Reed Relays

276

SPST, 10 A

SPDT, 7 A

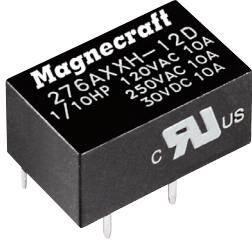

276

## Description

The 276 series relays offer high switching capacity in a small package.

Feature	Benefit
High current switching capacity	Enables the relay to switch up to 10 A
HP rated	UL approved to switch up to 1/10 hp
Low-profile design	Uses less than 12.7 mm <sup>2</sup> (0.5 in <sup>2</sup> ) of space on a PC board
Small footprint	Saves valuable space on a printed circuit board
Epoxy sealed	Allows the relay to be washed after assembly

Rated Output Load (A)	Contact Configuration	Input Voltage (Vdc)	Coil Resistance (Ω)	Standard Part Number
7	SPDT	5	125	276XAXH-5D
		12	720	276XAXH-12D
		24	2880	276XAXH-24D
10	SPST-NO	5	125	276AXXH-5D
		12	720	276AXXH-12D

### Part Number Explanation

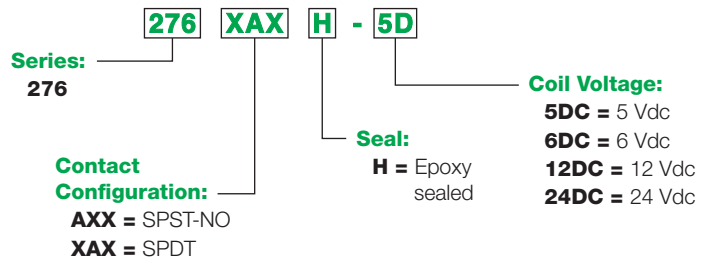

Specifications (UL 508)

Part Number	276XAX	276AXX
<b>Input Characteristics</b>		
Input Voltage Range	3–24 Vdc	
Operating Range (% of Nominal)	80%–110%	
Average Power Consumption	0.2 W	
Drop-out Voltage Threshold	10%	
<b>Output Characteristics</b>		
Contact Configuration	SPDT	SPST-NO
Contact Materials	Silver Alloy	
Output Current Load	7 A	10 A
Maximum Output Voltage	7 A @ 240 Vac 50/60 Hz; 7 A @ 30 Vdc; 1/10 hp @ 120 Vac	10 A @ 240 Vac 50/60 Hz; 10 A @ 30 Vdc; 1/6 hp @ 120 Vac
Minimum Switching Requirement	100 mA	
<b>General Characteristics</b>		
Electrical Life (Operations at rated current)	100,000 operations	
Mechanical Life (Unpowered)	5,000,000 operations	
Operating Time (Response time)	10 ms	
Dielectric Strength (Between coil and contact)	2000 Vac	
Dielectric Strength (Between contacts)	1000 Vac	
Storage Temperature Range	–40–85 °C (–40–185 °F)	
Operating Temperature Range	–40–70 °C (–40–158 °F)	
Vibration Resistance (Operational)	1.5 g-n, 10–55 Hz	
Shock Resistance	20 g-n	
Weight	5.5 g (0.19 oz)	
Agency Approvals	UR (E43641), RoHS	

Dimensions: Inches (Millimeters)

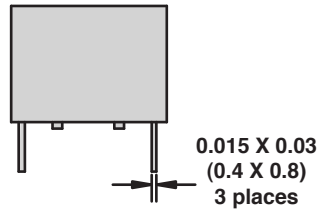
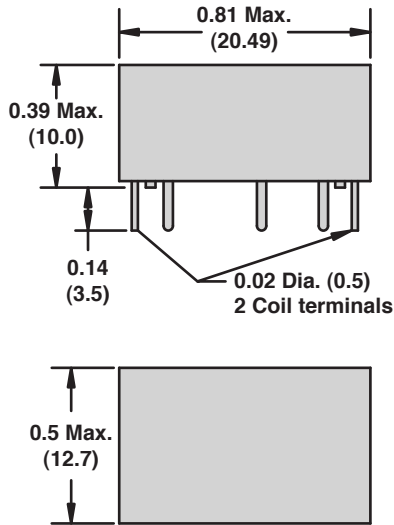

Circuit board pin spacing viewed from component side

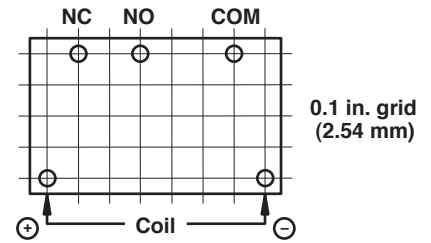

Wiring Diagrams

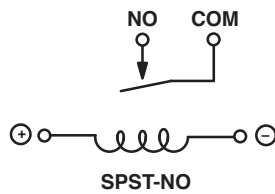
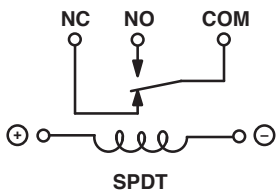

## Description

# Magnecraft® PCB & Reed Relays

976

SPDT, 12 to 20 A

DPDT, 5 A



976

## Description

The 976 series enclosed printed circuit board relays are used to switch resistive and inductive loads in industrial applications.

Feature	Benefit
High current switching capacity	Enables the relay to switch up to 20 A
AC coil voltages available	Expands application use
8 mm coil to contact clearance	Meets international standards
Epoxy sealed	Allows the relay to be washed after assembly

Rated Output Current (A)	Contact Configuration	Input Voltage	Coil Resistance (Ω)	Standard Part Number
5	DPDT	12 Vdc	270	976XBXH-12D
		24 Vac 50/60 Hz	250	976XBXH-24A
		24 Vdc	1100	976XBXH-24D
		120 Vac 50/60 Hz	5600	976XBXH-120A
		240 Vac 50/60 Hz	22000	976XBXH-240A
12	SPDT	24 Vac 50/60 Hz	250	976XAXH-24A
		24 Vdc	1100	976XAXH-24D
		120 Vac 50/60 Hz	5600	976XAXH-120A
		240 Vac 50/60 Hz	22000	976XAXH-240A
20	SPDT	24 Vac 50/60 Hz	250	976XAX97H-24A
		24 Vdc	1100	976XAX97H-24D
		120 Vac 50/60 Hz	5600	976XAX97H-120A

## Part Number Explanation

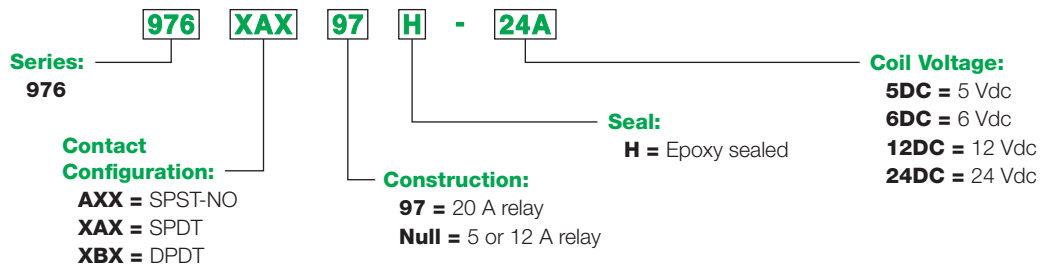

## Specifications (UL 508)

Part Number	976XAX97H	976XAXH	976XBXH
<b>Input Characteristics</b>			
Input Voltage Range	6–240 Vac; 3–110 Vdc		
Operating Range (% of Nominal)	85%–110%		
Average Consumption	1.2 VA; 0.53 W		
Drop-out Voltage Threshold	30% AC; 10% DC		
<b>Output Characteristics</b>			
Contact Configuration	SPDT	SPDT	DPDT
Contact Materials	Silver Alloy		
Output Current Load	20 A	12 A	5 A
Maximum Switching Voltage	300 V		
Output Voltage Range	20 A @ 125 Vac 50/60 Hz; 16 A @ Vac 50/60 Hz; 20 A @ 30 Vdc; 10 A @ 48 Vdc	NO: 12 A @ 240 vac 50/60 Hz, 12 A @ 30 Vdc; NC: 10 A @ 240 Vac 50/60 Hz, 10 A @ 30 Vdc	5 A @ 240 Vac 50/60 Hz; 5 A @ 30 Vdc
<b>General Characteristics</b>			
Electrical Life (Operations at Rated Current)	100,000 operations		
Mechanical Life (Unpowered)	10,000,000 operations		
Operating Time (Response time)	15 ms		
Dielectric Strength (Between coil and contact)	5000 V(rms)		
Dielectric Strength (Between contacts)	1000 V(rms)		
Storage Temperature Range	-40–85 °C (-40–185 °F)		
Operating Temperature Range	-40–55 °C (-40–131 °F)		
Vibration Resistance (Operational)	3 g-n, 10-55 Hz		
Shock Resistance	10 g-n		
Weight	17 g (0.6 oz)		
Agency Approvals	UR (E191122), TUV, RoHS		

Dimensions: Inches (Millimeters)

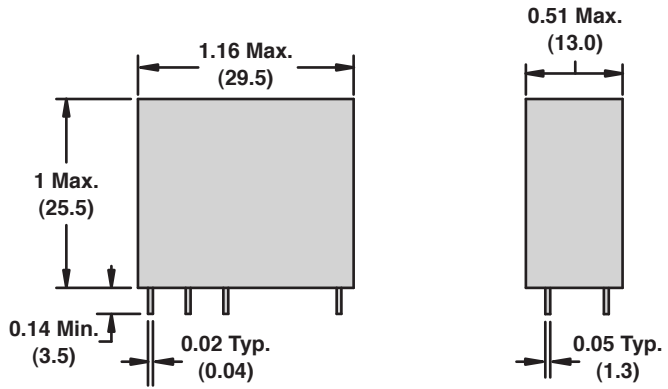

Circuit board pin spacing  
viewed from component side

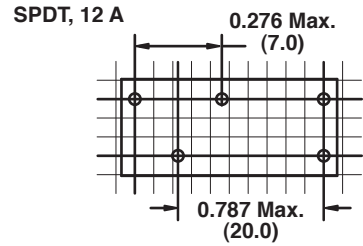

0.1 in. grid  
(2.54 mm)

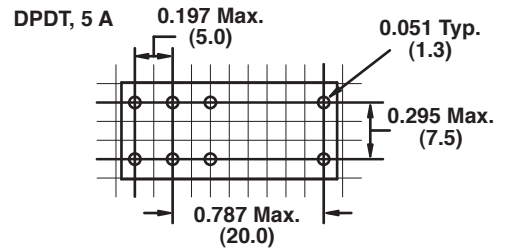
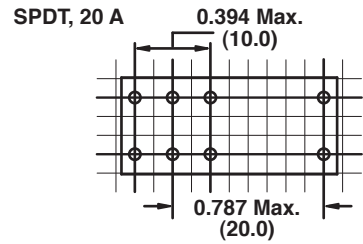

Wiring Diagrams

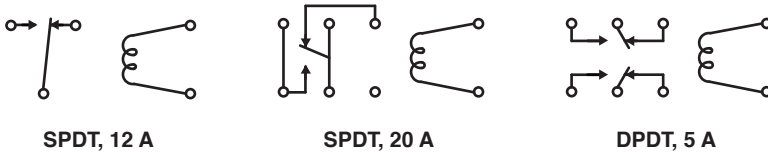



## Introduction

Printed circuit board (PCB) relays are compact relay devices used for power management in control system designs which require the relay to be mounted directly on the printed circuit board. They are used in applications where the relay must be small enough to be mounted on a printed circuit board. They must be easy to manufacture with the same machinery used in the printed circuit board line.

## How Electromechanical PCB Relays Work

Electromechanical PCB relays consist of a coil, armature and contacts (see figure below). When power is applied to the coil, the resulting magnetic field causes the armature to move and the contacts to open or close.

### Advantages

- Higher contact ratings than reed relays and smaller than traditional plug-in relays
- A wider range of form, fit and function than reed relays
- UL recognized to meet industry standards for product safety and compliance

## How Reed Relays Work

Reed relays consist of a coil wrapped around a sealed glass tube containing the reeds and contacts (see figure below). When power is applied to the coil, the resulting magnetic field causes the reeds to move and the contacts to close (1).

### Advantages

- Highly reliable due to longer mechanical and electrical life than electromechanical relays
- Can switch about ten times faster than an electromechanical relay with similar ratings
- Small, industry standard packaging which does not require unique machinery to populate

## Electromechanical PCB Relays vs. Reed Relays

Typical Electromechanical PCB Relay

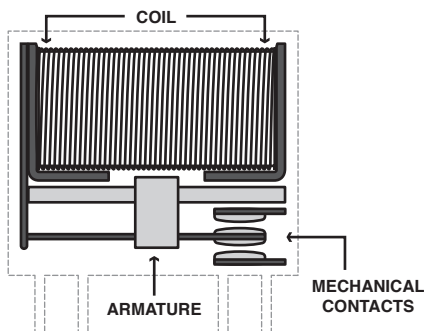

Typical Reed Relay

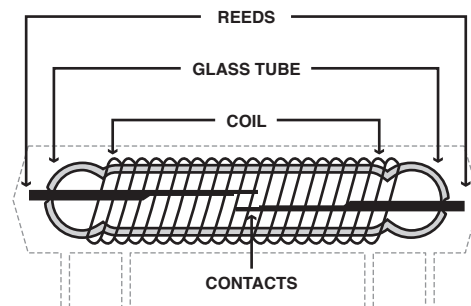

(1) Note that it is important to keep reed relays at a proper distance from each other because of the possibility of magnetic-interaction between them. Proper magnetic shielding must be used to contain stray magnetic fields. When installing reed relays into equipment, be aware of the devices in the equipment which can produce magnetic fields. Position the relays as far away as possible from any stray magnetic fields, and shield them to prevent false operations. A general rule is to space reed relays no closer together than 0.5 inches.

## Applications

The Magnecraft PCB relay offer consists of reed relays ideal for applications requiring fast, reliable low-level switching capability in a very small package, and electromechanical PCB relays ideal for applications requiring higher ratings than reed relays and a smaller package than traditional plug-in relays.

### Typical Examples of PCB and Reed Relay Applications



#### Automotive

*Anti-lock brake systems, cruise control, doors, power steering, power windows, sunroofs*



#### Electronics & Communication

*Cellular phones, computers, copiers, microphones, radio transmitters, speakers*

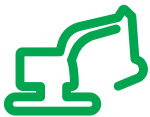

#### Construction & Security

*Conveyor belts, elevators, emergency lamps, hoists, lifts, security alarms*



#### HVAC & Refrigeration

*Air conditioners, blowers, compressors, motorized ducts/vents, refrigerators, space heaters*



#### Domestic Appliances

*Coffee machines, dish washers, food processors, microwaves, ovens, stoves, vacuum cleaners, washing machines*

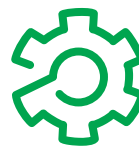

#### Industrial Automation

*Human/machine interfaces, motion controllers, PLCs, power supplies, solder/wave reflow systems, variable speed drives*

---

## The Magnecraft Range of Printed Circuit Board and Reed Relays

Printed circuit board and reed relays are compact devices used for high power and low level applications that require printed circuit board assembly.

## Selecting a Printed Circuit Board or Reed Relay

The list below is an example of the specifications to look for when selecting a printed circuit board or reed relay.

Input voltage:	_____
Coil resistance:	_____
Contact rating:	_____
Contact configuration:	_____
Mounting style:	_____

Use the catalog specifications or online parametric search to determine a recommended part number ([www.magnecraft.com](http://www.magnecraft.com)).

The Magnecraft website ([www.magnecraft.com](http://www.magnecraft.com)) was designed to enable users to easily find the proper relay to fit design requirements and to help simplify and shorten workflow.

## Easily find the proper relay to fit design requirements

### ■ Online Catalog

Find the right product by choosing specifications compare products side-by-side and view technical specifications, 2D and 3D drawings and associated accessories.

### ■ Cross Reference Search

Search our comprehensive database to identify by manufacturer and part number, and link directly to part specifications.

### ■ 3D CAD Library

View, email, download or insert a file directly into your open CAD software pane and select from 18 different file formats.

### ■ Order Free Samples

Magnecraft offers free samples as a courtesy to individuals and companies evaluating our products in their designs and applications. Sample orders are subject to approval.

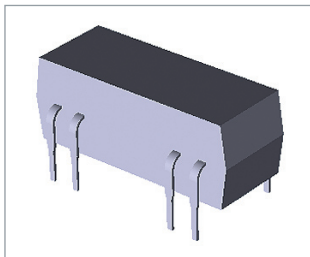

3D Models

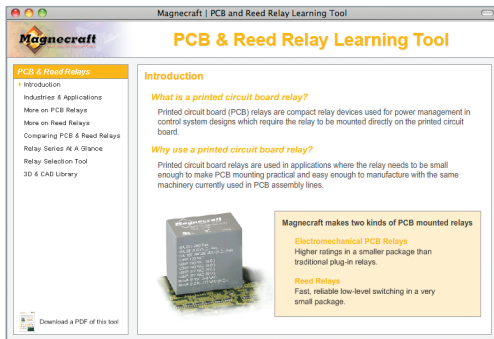

PCB & Reed Relay Learning Tool

## Simplify and shorten workflow

### ■ Interactive Tools

View interactive learning tools such as our PCB & Reed Relay Learning Tool which helps you learn more about Magnecraft's electromechanical PCB relays and reed relays, including industries and applications, principles of operation and advantages of using each type of relay.

### ■ Distributor Inventory Search

Search authorized distributors' current Magnecraft inventory and buy online. (Buy online not available for all distributors).







**Schneider Electric USA, Inc.**

[www.magnecraft.com](http://www.magnecraft.com)

1300 S. Wolf Rd.  
Des Plaines, IL 60018  
Tel: 847-441-2540

The information and dimensions in this catalog are provided for the convenience of our customers. While this information is believed to be accurate, Schneider Electric reserves the right to make updates and changes without prior notification and assumes no liability for any errors or omissions.

Design: Schneider Electric  
Photos: Schneider Electric

© 2010 Schneider Electric. All Rights Reserved.

September 2010

8501CT1001