

3-conductor through terminal block

Item No.: 284-681

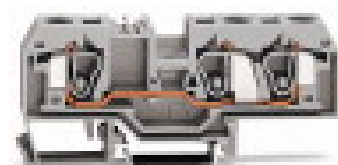

3-conductor through terminal block

Marking

RoHS ✓
Compliant

Business data

Supplier	WAGO
Item no.	284-681
GTIN / EAN	4044918447379
Content	1
Order amount	25
Customer item number	

Notes

Technical data

Miscellaneous

Total number of connection points	3
Total number of potentials	1
Color	gray
Ratings according to 1	IEC/EN 60947-7-1
Pollution degree (1)	3
Rated voltage EN (1) [V]	800 [V]
Rated surge voltage (1) [kV]	8 [kV]
Nominal current [A]	57 [A]
Connection technology (1)	CAGE CLAMP®
Solid sizes 1	0.2 ... 10 mm ² / 24 ... 8 AWG

Technical data	
<i>Fine-stranded wires 1</i>	<i>0.2 ... 10 mm² / 24 ... 8 AWG</i>
<i>Strip length 1</i>	<i>12 ... 13 mm / 0.47 ... 0.51 in</i>
<i>Type of wiring</i>	<i>Front-entry wiring</i>
<i>Design</i>	<i>horizontal</i>
<i>Marking level</i>	<i>Center marking</i>
<i>Insulating material</i>	<i>Polyamide 66 (PA 66)</i>
<i>Fire load [MJ]</i>	<i>0.435 [MJ]</i>
<i>Weight [g]</i>	<i>31.99 [g]</i>
<i>Width</i>	<i>10 mm / 0.394 in</i>
<i>Height from upper-edge of DIN-rail [mm]</i>	<i>35 [mm]</i>
<i>Height from upper-edge of DIN-rail</i>	<i>35 mm / 1.378 in</i>
<i>Length</i>	<i>97.5 mm / 3.839 in</i>
<i>Type of mounting</i>	<i>DIN 35 rail</i>

Images & drawings

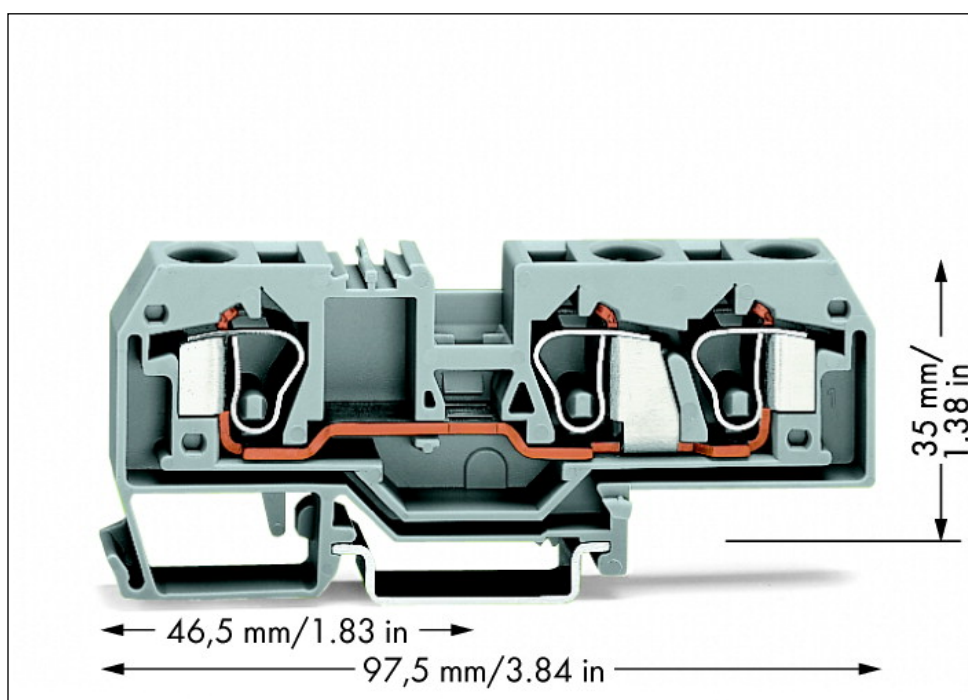
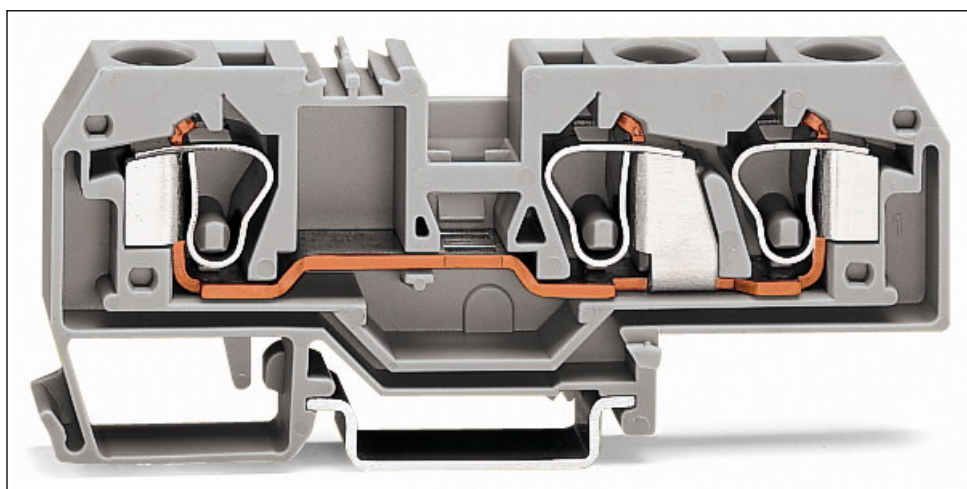

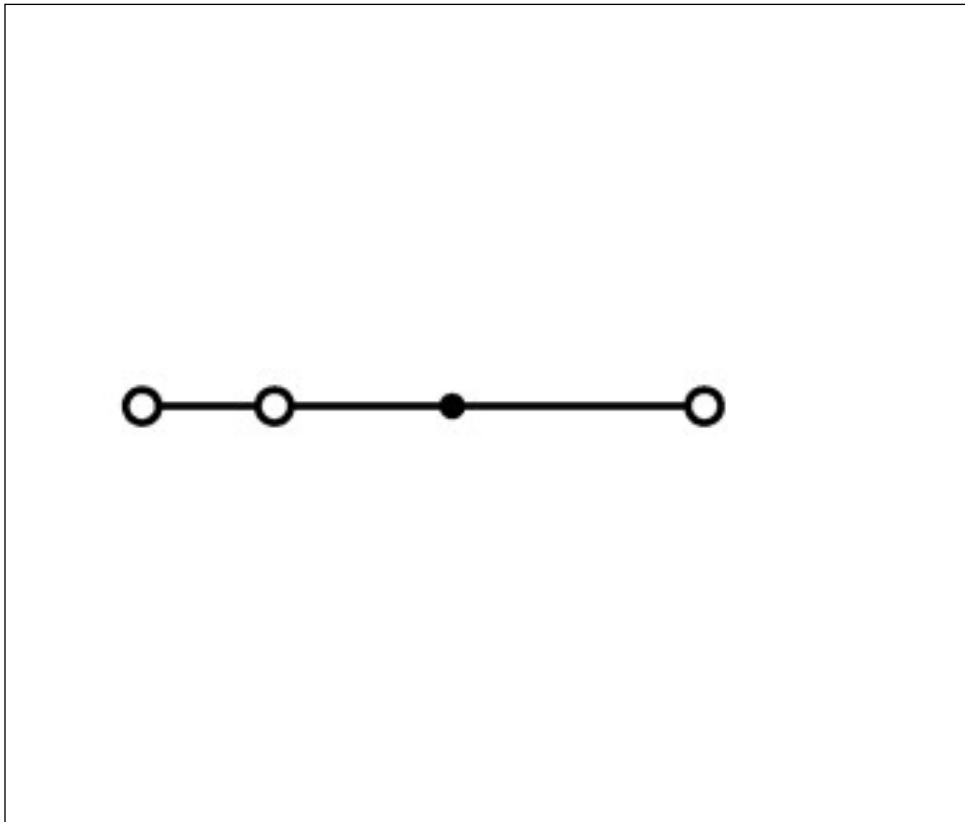

Address

WAGO Kontakttechnik GmbH & Co. KG

Hansastr. 27

32423 Minden

Telefon: 0571/887-0

Fax: 0571/887-169

<http://www.wago.com>

© WAGO Kontakttechnik GmbH & Co. KG

Technische Änderungen und Irrtümer vorbehalten.