

LOC	DIST	REV	DATE	BY	CHKD	APVD
AD	00	B	04JAN12	KH		DY

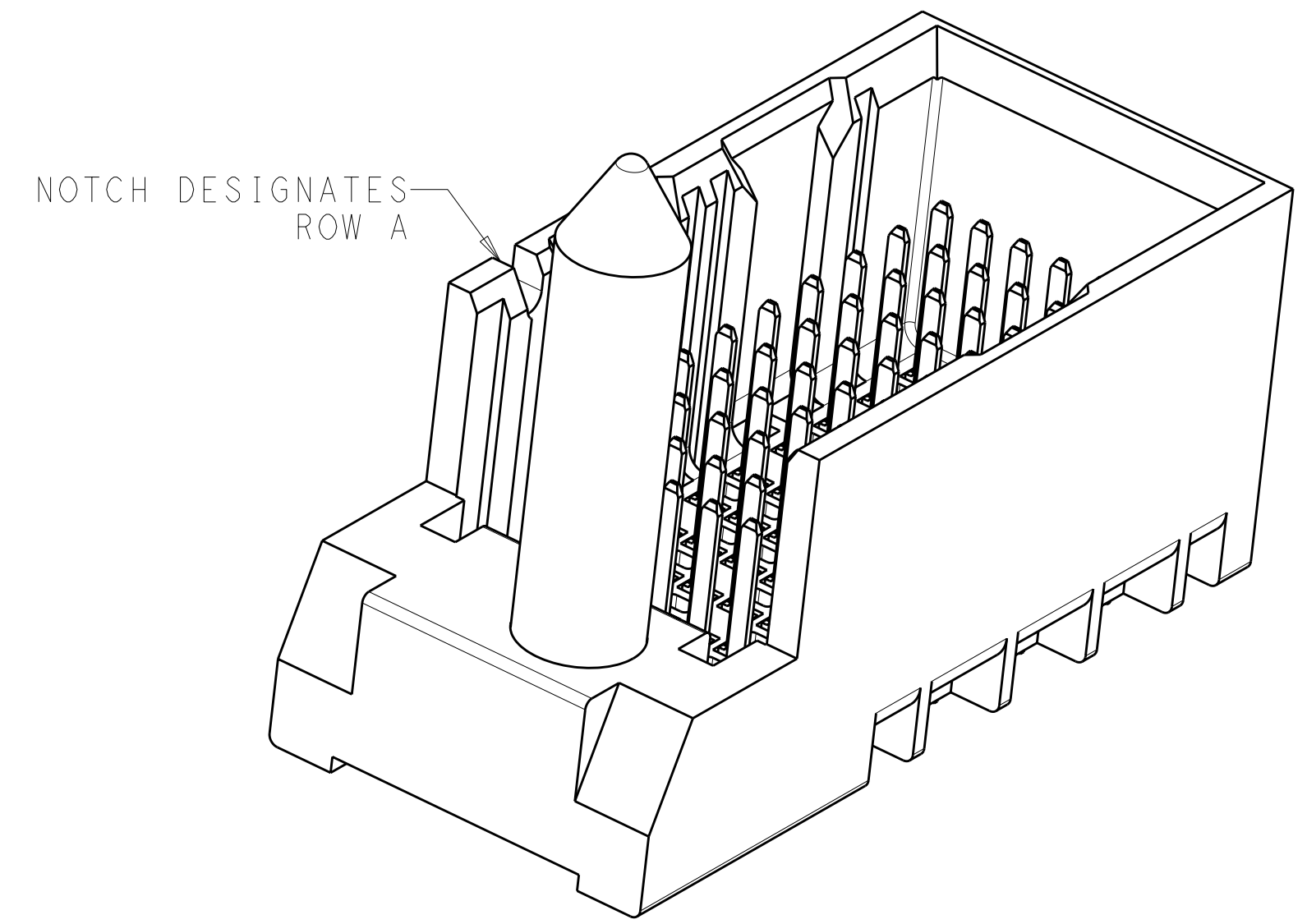

- 1 MATERIAL:  
HOUSING: LCP, GLASS FILLED, UL94V-0.  
TERMINALS: HIGH PERFORMANCE COPPER ALLOY.
- 2 FINISH:  
30µ" MIN GOLD IN CONTACT AREA. SELECTIVE TIN ON PCB TAILS, NICKEL OVERALL.
- 3 FINISH:  
30µ" MIN GOLD IN CONTACT AREA. SELECTIVE TIN-LEAD ON PCB TAILS, NICKEL OVERALL.
- 4. SCREWS PACKAGED IN END OF PACKAGING TUBE.
- 5 FOR GROUNDED GUIDE PIN USE Ø3.56±0.08 PTH, Ø3.66 DRILL, AND Ø6.5 PAD.

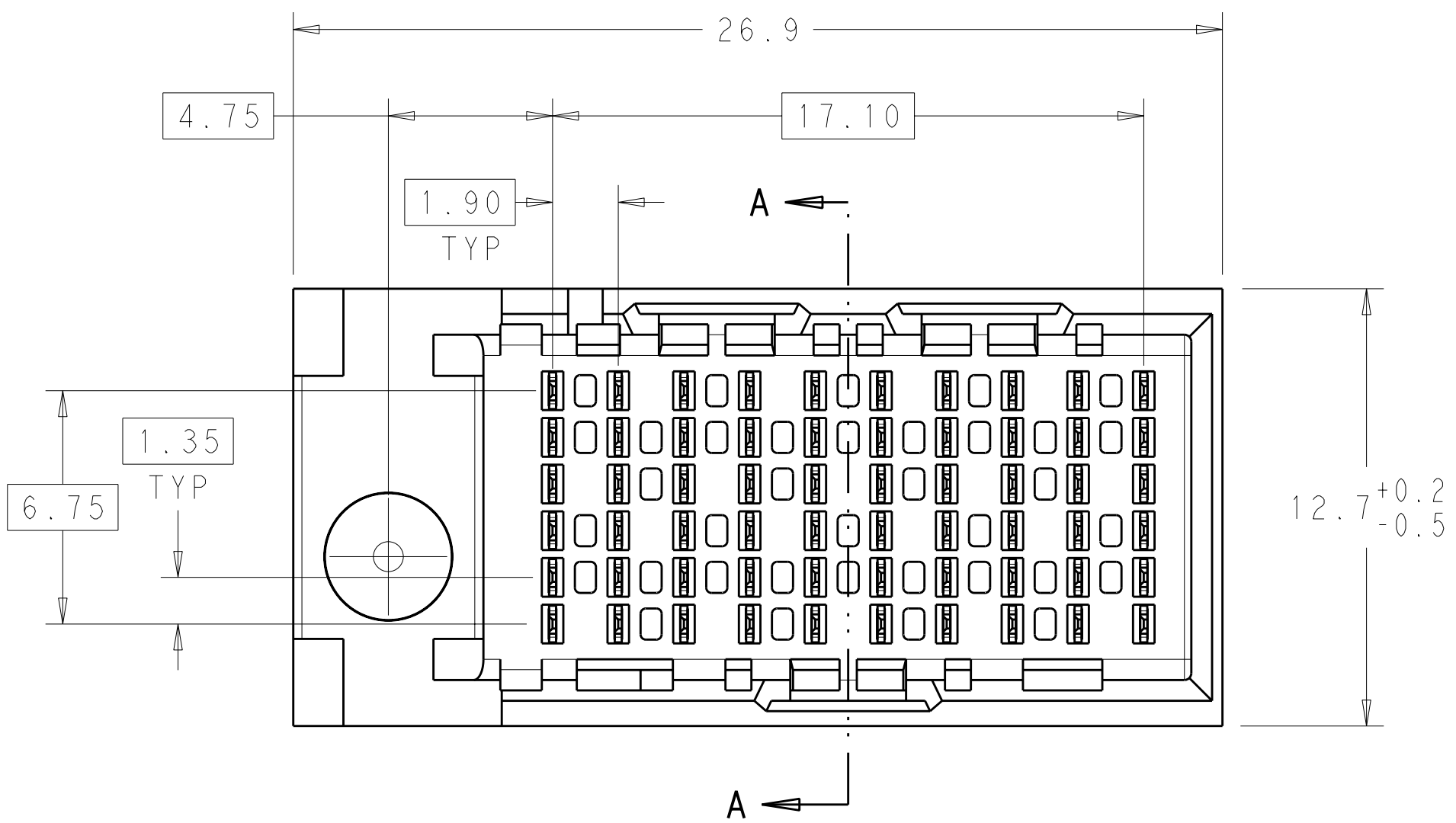
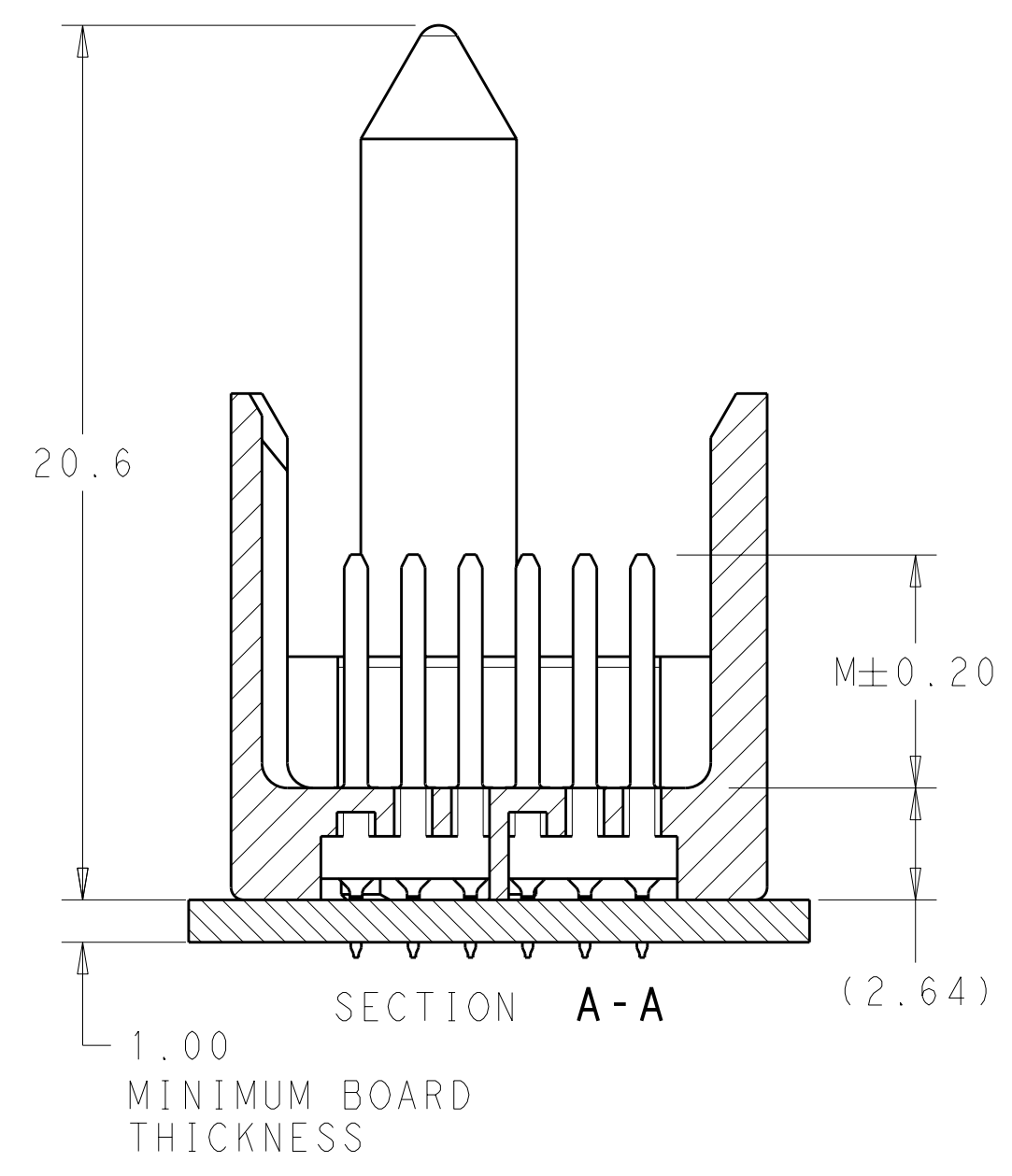
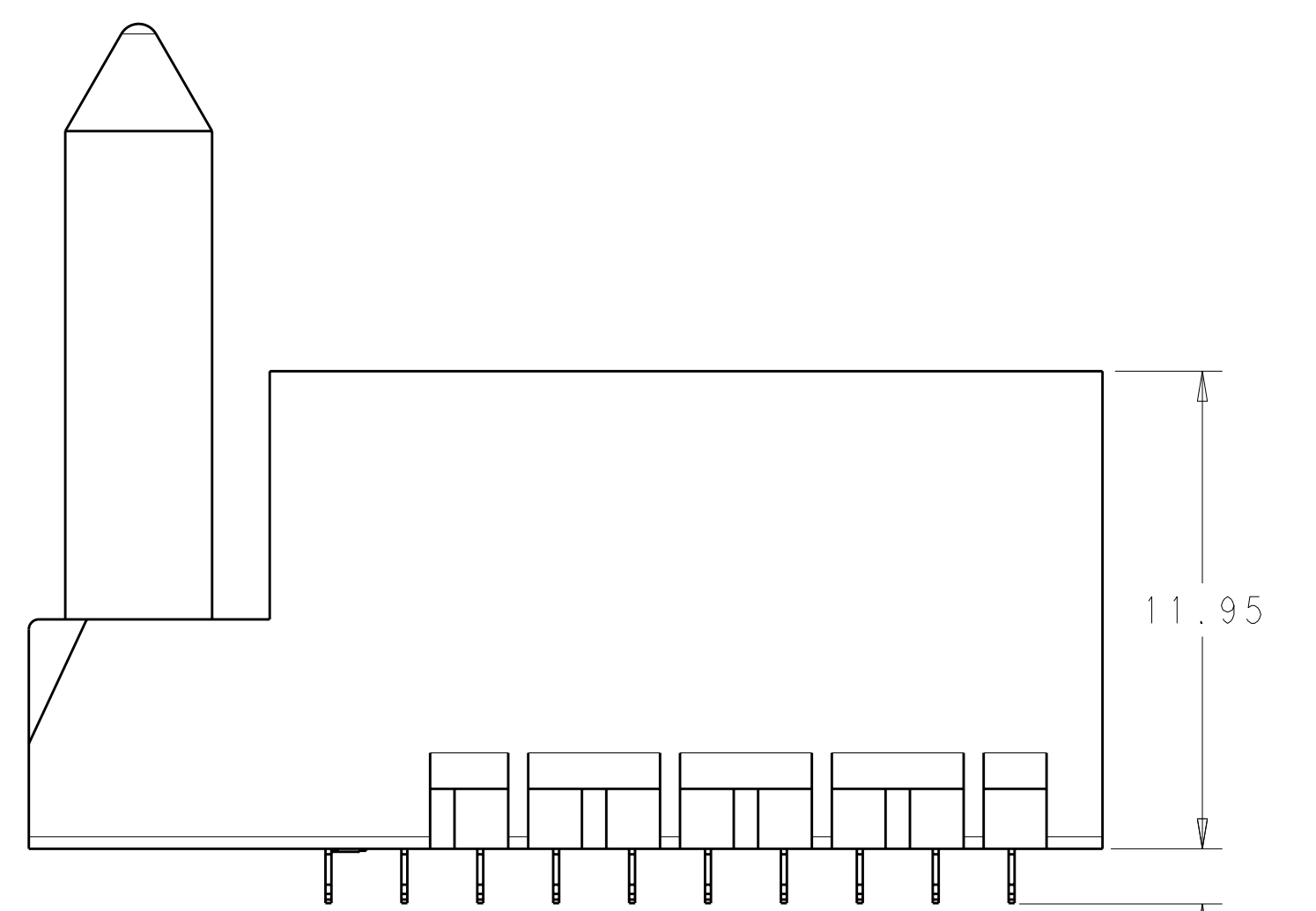
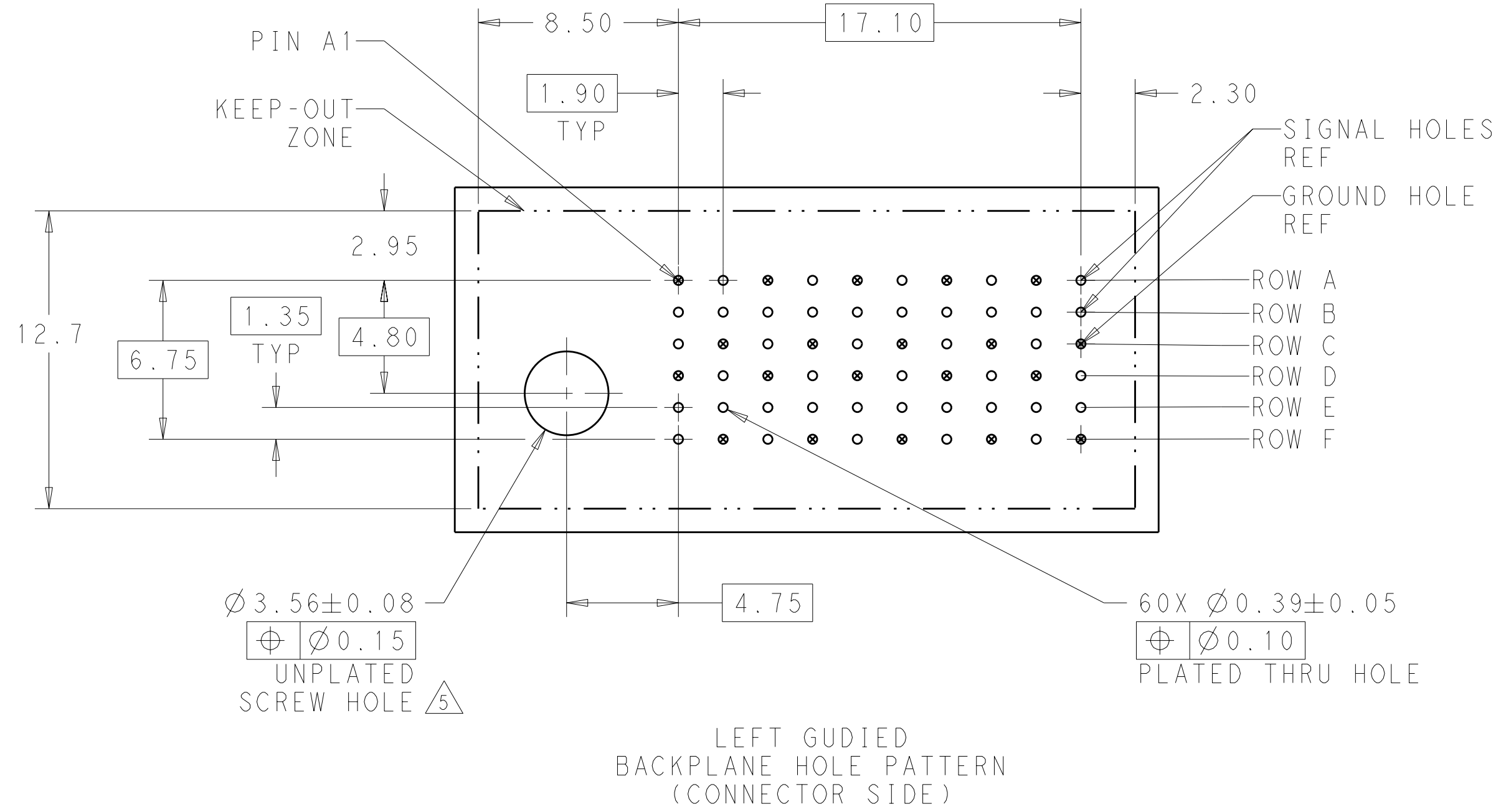

THIS DRAWING IS A CONTROLLED DOCUMENT.		DWN J. K. SHOBER 04JAN12	TE Connectivity
DIMENSIONS: mm		CHK J. EBY 04JAN12	
TOLERANCES UNLESS OTHERWISE SPECIFIED:		APVD J. EBY 04JAN12	NAME IMPACT, 2 PAIR, 10 COLUMN, HEADER LEFT GUIDED, RIGHT END WALL SIGNAL MODULE, 0.36 PTH
9 PLC ± 1 PLC ±0.25 3 PLC ±0.13 5 PLC ± 4 PLC ± ANGLES ±		PRODUCT SPEC	SIZE CAGE CODE DRAWING NO. RESTRICTED TO
MATERIAL SEE TABLE		APPLICATION SPEC	A100779C=2057421
FINISH SEE TABLE		WEIGHT	SCALE 6:1 SHEET 1 OF 2 REV B
CUSTOMER DRAWING		SCALE 6:1	REV B

THIS DRAWING IS UNPUBLISHED. RELEASED FOR PUBLICATION 20  
 © COPYRIGHT 20 . . . ALL RIGHTS RESERVED.

LOC	DIST	REVISIONS				
		P	LTB	DATE	DWN	APVD
AD	00	-	-	SEE SHEET 1	-	-

FINISH	DIM M	PART NUMBER
$\triangle_3$	5.5	2057421-6
$\triangle_3$	4.9	2057421-5
$\triangle_3$	4.5	2057421-4
$\triangle_2$	5.5	2057421-3
$\triangle_2$	4.9	2057421-2
$\triangle_2$	4.5	2057421-1

REFER TO WWW.TE.COM  
FOR PRODUCT AVAILABILITY

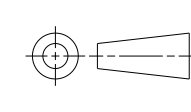
THIS DRAWING IS A CONTROLLED DOCUMENT.		DWN J. K. SHOBER	04JAN12	 TE Connectivity NAME IMPACT, 2 PAIR, 10 COLUMN, HEADER LEFT GUIDED, RIGHT END WALL SIGNAL MODULE, 0.36 PTH
DIMENSIONS: mm		CHK J. EABY	04JAN12	
		APVD J. EABY	04JAN12	
TOLERANCES UNLESS OTHERWISE SPECIFIED: 9 PLC ± 1 PLC ±0.25 2 PLC ±0.13 3 PLC ± 4 PLC ± ANGLES ± FINISH ±		PRODUCT SPEC APPLICATION SPEC WEIGHT CUSTOMER DRAWING		SIZE CAGE CODE DRAWING NO A100779C=2057421 RESTRICTED TO -
MATERIAL		SCALE 5:1		SHEET 2 OF 2
		REV B		

# Mouser Electronics

Authorized Distributor

Click to View Pricing, Inventory, Delivery & Lifecycle Information:

[TE Connectivity:](#)

[2057421-2](#)