

Female Style 1/2 Q Press-Fit



Series 8478 – 2 rows (2 x 16) Inverted



Contact Design and Termination Length	Number of Contacts	Loading Description	Part Number Performance classes according to DIN 41612	
			II	I
for ≥ 2.4 mm PCB's 0.6 x 0.6 mm Post Profile 5.3 mm (Y) Right Angled	32	a + b fully loaded	20 8478 032 001 025	20 8478 032 001 049
	16	a + b even loading	20 8478 032 001 031	20 8478 032 001 055
	16	a loading only	20 8478 032 001 027	20 8478 032 001 051
for 1.6 mm PCB's 0.6 x 0.6 mm Post Profile 2.9 mm (Y) Right Angled	32	a + b fully loaded	20 8478 032 031 025	20 8478 032 031 049
	16	a + b even loading	20 8478 032 031 031	20 8478 032 031 055
	16	a loading only	20 8478 032 031 027	20 8478 032 031 051

NB: Alternative Prefix Variations Available: 22, please refer to Page 10.
 Additional Plating & Loading Variations: Please contact your local AVX sales office or distributor.

LOADING DESCRIPTION



32 contacts, rows a + b fully loaded

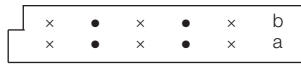

16 contacts, rows a + b even loading

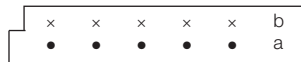

16 contacts, row a loading only

DIMENSIONS

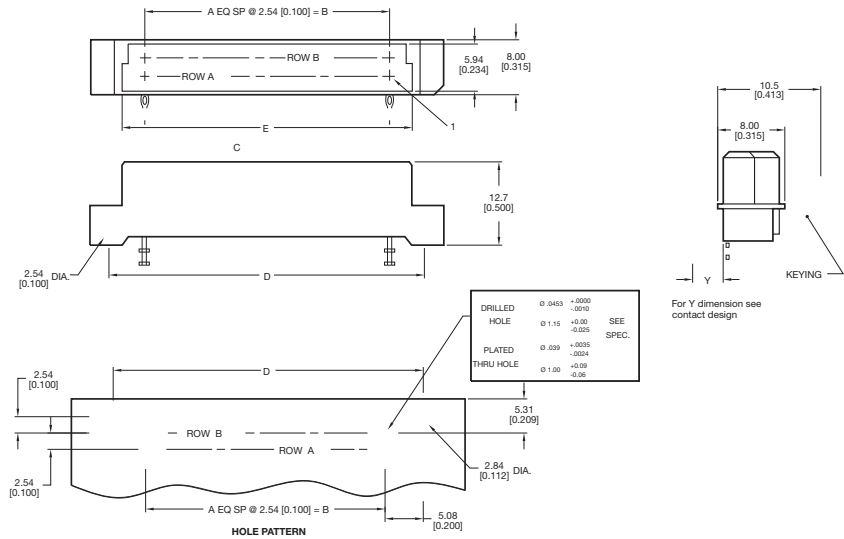

Assembly Tool: 06 8478 8421 00 000 (see page 67)

Unit: millimeters (inches)









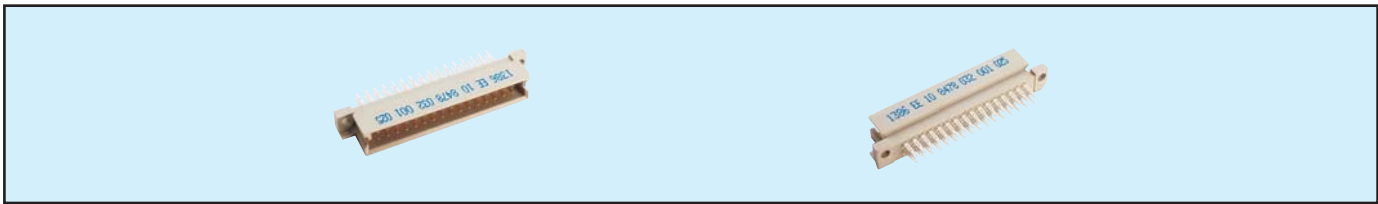

No. Contact Positions	Contact Rows	A	B	C	D	E
64	2 (2 x 32)	31	78.74 (3.100)	93.90 (3.697)	88.90 (3.500)	84.91 (3.343)

Male Style 1/2 Q Press-Fit



Series 8478 – 2 rows (2 x 16) Inverted



Contact Design and Termination Length	Number of Contacts	Loading Description	Part Number Performance classes according to DIN 41612	
			II	I
for ≥ 2.4 mm PCB's 0.6 x 0.6 mm Post Profile 5.3 mm (Y) Straight 	32	a + b fully loaded	10 8478 032 001 025	10 8478 032 001 049
	16	a + b even loading	10 8478 032 001 031	10 8478 032 001 055
	16	a loading only	10 8478 032 001 027	10 8478 032 001 051
	30 + 2	fully loaded + ground	10 8478 032 101 025	10 8478 032 101 049
for ≥ 2.4 mm PCB's 0.6 x 0.6 mm Post Profile 9.3 mm (Y) Straight 	32	a + b fully loaded	10 8478 032 002 025	10 8478 032 002 049
	16	a + b even loading	10 8478 032 002 031	10 8478 032 002 055
	16	a loading only	10 8478 032 002 027	10 8478 032 002 051
	30 + 2	fully loaded + ground	10 8478 032 102 025	10 8478 032 102 049
for ≥ 2.4 mm PCB's 0.6 x 0.6 mm Post Profile 16.2 mm (Y) Straight 	32	a + b fully loaded	10 8478 032 003 025	10 8478 032 003 049
	16	a + b even loading	10 8478 032 003 031	10 8478 032 003 055
	16	a loading only	10 8478 032 003 027	10 8478 032 003 051
	30 + 2	fully loaded + ground	10 8478 032 103 025	10 8478 032 103 049
for ≥ 2.4 mm PCB's 0.6 x 0.6 mm Post Profile 18.2 mm (Y) Straight 	32	a + b fully loaded	10 8478 032 004 025	10 8478 032 004 049
	16	a + b even loading	10 8478 032 004 031	10 8478 032 004 055
	16	a loading only	10 8478 032 004 027	10 8478 032 004 051
	30 + 2	fully loaded + ground	10 8478 032 104 025	10 8478 032 104 049
for ≥ 2.4 mm PCB's 0.6 x 0.6 mm Post Profile 14.6 mm (Y) Straight 	32	a + b fully loaded	10 8478 032 005 025	10 8478 032 005 049
	16	a + b even loading	10 8478 032 005 031	10 8478 032 005 055
	16	a loading only	10 8478 032 005 027	10 8478 032 005 051
	30 + 2	fully loaded + ground	10 8478 032 105 025	10 8478 032 105 049
for ≥ 2.4 mm PCB's 0.6 x 0.6 mm Post Profile 13.2 mm (Y) Straight 	32	a + b fully loaded	10 8478 032 006 025	10 8478 032 006 049
	16	a + b even loading	10 8478 032 006 031	10 8478 032 006 055
	16	a loading only	10 8478 032 006 027	10 8478 032 006 051
	30 + 2	fully loaded + ground	10 8478 032 106 025	10 8478 032 106 049
for ≥ 2.4 mm PCB's 0.6 x 0.6 mm Post Profile 23.2 mm (Y) Straight 	32	a + b fully loaded	10 8478 032 007 025	10 8478 032 007 049
	16	a + b even loading	10 8478 032 007 031	10 8478 032 007 055
	16	a loading only	10 8478 032 007 027	10 8478 032 007 051
	30 + 2	fully loaded + ground	10 8478 032 107 025	10 8478 032 107 049
for ≥ 2.4 mm PCB's 0.6 x 0.6 mm Post Profile 20.0 mm (Y) Straight 	32	a + b fully loaded	10 8478 032 008 025	10 8478 032 008 049
	16	a + b even loading	10 8478 032 008 031	10 8478 032 008 055
	16	a loading only	10 8478 032 008 027	10 8478 032 008 051
	30 + 2	fully loaded + ground	10 8478 032 108 025	10 8478 032 108 049
for ≥ 2.4 mm PCB's 0.6 x 0.6 mm Post Profile 3.9 mm (Y) Straight 	32	a + b fully loaded	10 8478 032 009 025	10 8478 032 009 049
	16	a + b even loading	10 8478 032 009 031	10 8478 032 009 055
	16	a loading only	10 8478 032 009 027	10 8478 032 009 051
	30 + 2	fully loaded + ground	10 8478 032 109 025	10 8478 032 109 049
for 1.6 mm PCB's 0.6 x 0.6 mm Post Profile 3.0 mm (Y) Straight 	32	a + b fully loaded	10 8478 032 031 025	10 8478 032 031 049
	16	a + b even loading	10 8478 032 031 031	10 8478 032 031 055
	16	a loading only	10 8478 032 031 027	10 8478 032 031 051

NB: Alternative Prefix Variations Available: 21, 22 & 23, please refer to Page 10.

Additional Plating & Loading Variations: Please contact your local AVX sales office or distributor.

Installed using Flat Rock method (see page 66)

Male Style 1/2 Q Press-Fit



Series 8478 – 2 rows (2 x 16) Inverted

LOADING DESCRIPTION



32 contacts, rows a + b fully loaded

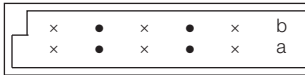

16 contacts, rows a + b even loading

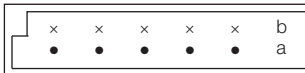

16 contacts, row a loading only

DIMENSIONS

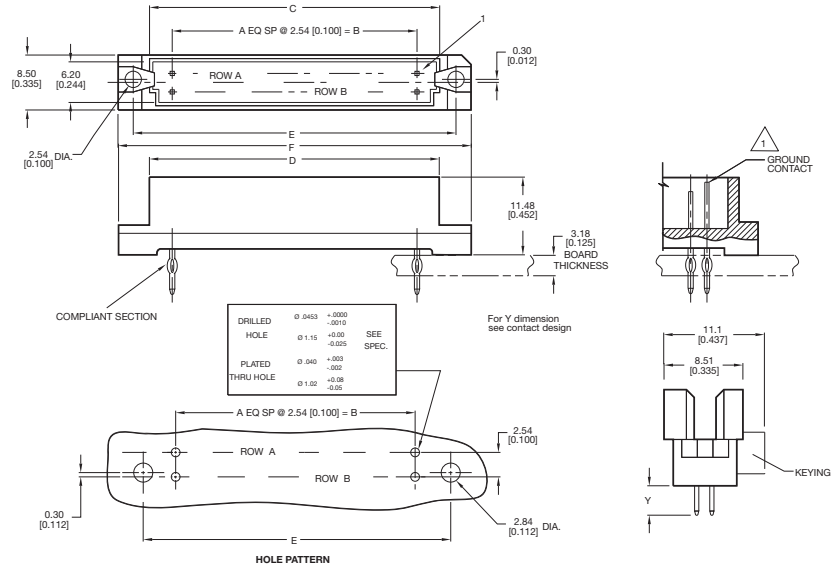

Unit: millimeters (inches)

No. Contact Positions	Contact Rows	A	B	C	D	E	F
32	2 (2 x 16)	15	38.10 (1.500)	44.70 (1.760)	47.29 (1.862)	49.99 (1.968)	54.91 (2.162)

Female Style Q Press-Fit



Series 8478 – 2 rows (2 x 32) Inverted

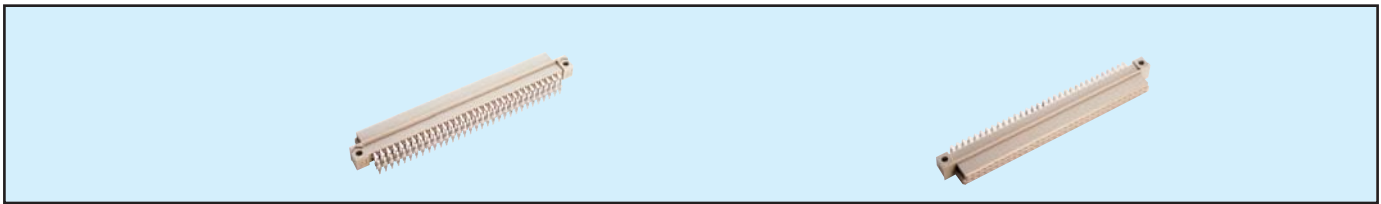

Contact Design and Termination Length	Number of Contacts	Loading Description	Part Number Performance classes according to DIN 41612	
			II	I
for ≥ 2.4 mm PCB's 0.6 x 0.6 mm Post Profile 5.3 mm (Y) Right Angled	64	a + b fully loaded	20 8478 064 001 025	20 8478 064 001 049
	32	a + b even loading	20 8478 064 001 031	20 8478 064 001 055
	32	a loading only	20 8478 064 001 027	20 8478 064 001 051
for 1.6 mm PCB's 0.6 x 0.6 mm Post Profile 2.9 mm (Y) Right Angled	64	a + b fully loaded	20 8478 064 031 025	20 8478 064 031 049
	32	a + b even loading	20 8478 064 031 031	20 8478 064 031 055
	32	a loading only	20 8478 064 031 027	20 8478 064 031 051

NB: Alternative Prefix Variations Available: 22, please refer to Page 10.
 Additional Plating & Loading Variations: Please contact your local AVX sales office or distributor.

LOADING DESCRIPTION

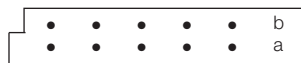

64 contacts, rows a + b fully loaded



32 contacts, rows a + b even loading



32 contacts, row a loading only

DIMENSIONS

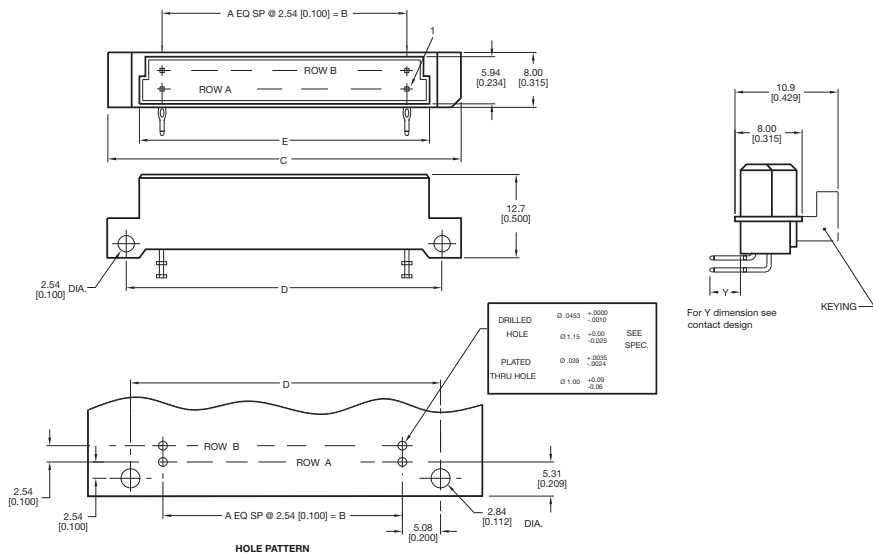

Assembly Tool: 06 8478 8461 00 000 (see page 67)

Unit: millimeters (inches)









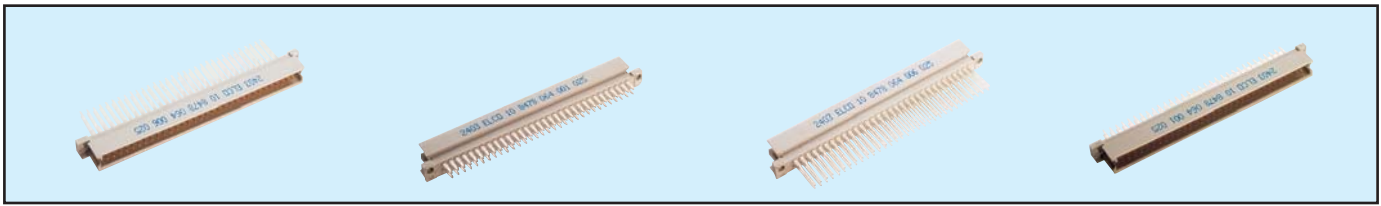

No. Contact Positions	Contact Rows	A	B	C	D	E
64	2 (2 x 32)	31	78.74 (3.100)	93.90 (3.697)	88.90 (3.500)	84.91 (3.343)

Male Style Q Press-Fit



Series 8478 – 2 rows (2 x 32) Inverted



Contact Design and Termination Length	Number of Contacts	Loading Description	Part Number Performance classes according to DIN 41612	
			II	I
for ≥ 2.4 mm PCB's 0.6 x 0.6 mm Post Profile 5.3 mm (Y) Straight 	64	a + b fully loaded	10 8478 064 001 025	10 8478 064 001 049
	32	a + b even loading	10 8478 064 001 031	10 8478 064 001 055
	32	a loading only	10 8478 064 001 027	10 8478 064 001 051
	62 + 2	fully loaded + ground	10 8478 064 101 025	10 8478 064 101 049
for ≥ 2.4 mm PCB's 0.6 x 0.6 mm Post Profile 9.3 mm (Y) Straight 	64	a + b fully loaded	10 8478 064 002 025	10 8478 064 002 049
	32	a + b even loading	10 8478 064 002 031	10 8478 064 002 055
	32	a loading only	10 8478 064 002 027	10 8478 064 002 051
	62 + 2	fully loaded + ground	10 8478 064 102 025	10 8478 064 102 049
for ≥ 2.4 mm PCB's 0.6 x 0.6 mm Post Profile 16.2 mm (Y) Straight 	64	a + b fully loaded	10 8478 064 003 025	10 8478 064 003 049
	32	a + b even loading	10 8478 064 003 031	10 8478 064 003 055
	32	a loading only	10 8478 064 003 027	10 8478 064 003 051
	62 + 2	fully loaded + ground	10 8478 064 103 025	10 8478 064 103 049
for ≥ 2.4 mm PCB's 0.6 x 0.6 mm Post Profile 18.2 mm (Y) Straight 	64	a + b fully loaded	10 8478 064 004 025	10 8478 064 004 049
	32	a + b even loading	10 8478 064 004 031	10 8478 064 004 055
	32	a loading only	10 8478 064 004 027	10 8478 064 004 051
	62 + 2	fully loaded + ground	10 8478 064 104 025	10 8478 064 104 049
for ≥ 2.4 mm PCB's 0.6 x 0.6 mm Post Profile 14.6 mm (Y) Straight 	64	a + b fully loaded	10 8478 064 005 025	10 8478 064 005 049
	32	a + b even loading	10 8478 064 005 031	10 8478 064 005 055
	32	a loading only	10 8478 064 005 027	10 8478 064 005 051
	62 + 2	fully loaded + ground	10 8478 064 105 025	10 8478 064 105 049
for ≥ 2.4 mm PCB's 0.6 x 0.6 mm Post Profile 13.2 mm (Y) Straight 	64	a + b fully loaded	10 8478 064 006 025	10 8478 064 006 049
	32	a + b even loading	10 8478 064 006 031	10 8478 064 006 055
	32	a loading only	10 8478 064 006 027	10 8478 064 006 051
	62 + 2	fully loaded + ground	10 8478 064 106 025	10 8478 064 106 049
for ≥ 2.4 mm PCB's 0.6 x 0.6 mm Post Profile 23.2 mm (Y) Straight 	64	a + b fully loaded	10 8478 064 007 025	10 8478 064 007 049
	32	a + b even loading	10 8478 064 007 031	10 8478 064 007 055
	32	a loading only	10 8478 064 007 027	10 8478 064 007 051
	62 + 2	fully loaded + ground	10 8478 064 107 025	10 8478 064 107 049
for ≥ 2.4 mm PCB's 0.6 x 0.6 mm Post Profile 20.0 mm (Y) Straight 	64	a + b fully loaded	10 8478 064 008 025	10 8478 064 008 049
	32	a + b even loading	10 8478 064 008 031	10 8478 064 008 055
	32	a loading only	10 8478 064 008 027	10 8478 064 008 051
	62 + 2	fully loaded + ground	10 8478 064 108 025	10 8478 064 108 049
for ≥ 2.4 mm PCB's 0.6 x 0.6 mm Post Profile 3.9 mm (Y) Straight 	64	a + b fully loaded	10 8478 064 009 025	10 8478 064 009 049
	32	a + b even loading	10 8478 064 009 031	10 8478 064 009 055
	32	a loading only	10 8478 064 009 027	10 8478 064 009 051
	62 + 2	fully loaded + ground	10 8478 064 109 025	10 8478 064 109 049
for 1.6 mm PCB's 0.6 x 0.6 Post Profile 3.0 mm (Y) Straight 	64	a + b fully loaded	10 8478 064 031 025	10 8478 064 031 049
	32	a + b even loading	10 8478 064 031 031	10 8478 064 031 055
	32	a loading only	10 8478 064 031 027	10 8478 064 031 051
	30 + 2	fully loaded + ground	10 8478 064 131 025	10 8478 064 131 049

NB: Alternative Prefix Variations Available: 21, 22 & 23, please refer to Page 10.

Additional Plating & Loading Variations: Please contact your local AVX sales office or distributor.

Installed using Flat Rock method (see page 66)

Male Style Q Press-Fit

Series 8478 – 2 rows (2 x 32) Inverted



LOADING DESCRIPTION

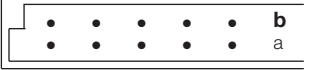

64 contacts, rows a + b fully loaded

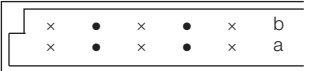

32 contacts, rows a + b even loading

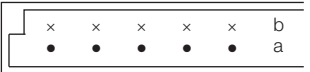

32 contacts, row a loading only

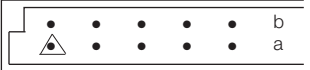

30 + 2 contacts, fully loaded with ground in A1 & A16

△ denotes ground pin

DIMENSIONS

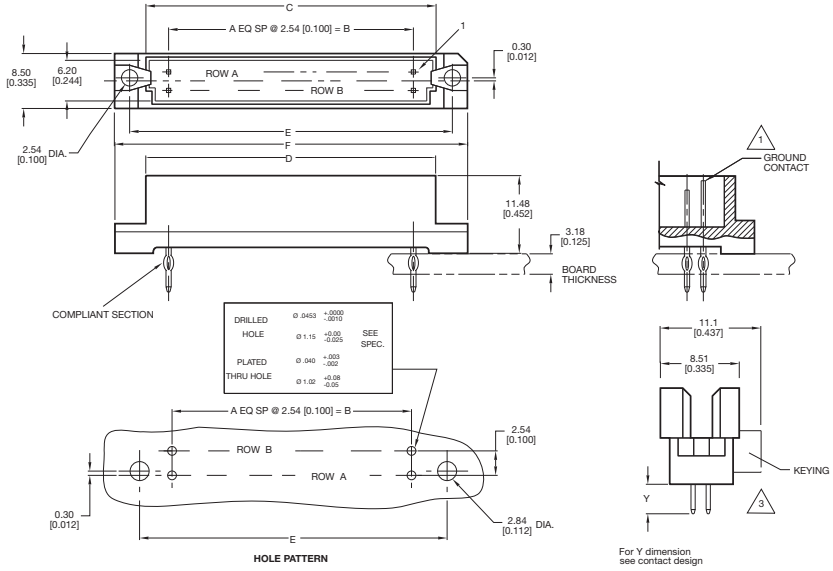

Unit: millimeters (inches)

No. Contact Positions	Contact Rows	A	B	C	D	E	F
64	2 (2 x 32)	31	78.74 (3.100)	85.29 (3.358)	87.91 (3.461)	89.99 (3.543)	94.89 (3.763)

Male Style 1/3 R Press-Fit



Series 8478 – 3 rows (3 x 10) Inverted

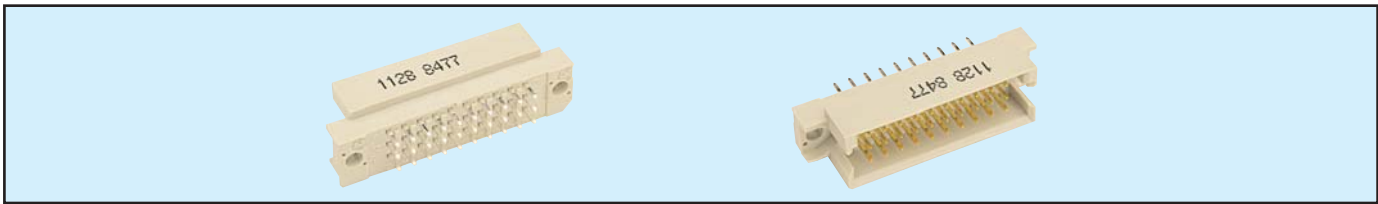

Contact Design and Termination Length	Number of Contacts	Loading Description	Part Number Performance classes according to DIN 41612	
			II	I
for ≥ 2.4 mm PCB's 0.6 x 0.6 mm Post Profile 5.3 mm (Y) Straight	30	a + b + c fully loaded	10 8478 030 001 025	10 8478 030 001 049
	20	a + c fully loaded	10 8478 030 001 026	10 8478 030 001 050
	28 + 2	fully loaded + ground	10 8478 030 101 025	10 8478 030 101 049
for ≥ 2.4 mm PCB's 0.6 x 0.6 mm Post Profile 9.3 mm (Y) Straight	30	a + b + c fully loaded	10 8478 030 002 025	10 8478 030 002 049
	20	a + c fully loaded	10 8478 030 002 026	10 8478 030 002 050
	28 + 2	fully loaded + ground	10 8478 030 102 025	10 8478 030 102 049
for ≥ 2.4 mm PCB's 0.6 x 0.6 mm Post Profile 16.2 mm (Y) Straight	30	a + b + c fully loaded	10 8478 030 003 025	10 8478 030 003 049
	20	a + c fully loaded	10 8478 030 003 026	10 8478 030 003 050
	28 + 2	fully loaded + ground	10 8478 030 103 025	10 8478 030 103 049
for ≥ 2.4 mm PCB's 0.6 x 0.6 mm Post Profile 18.2 mm (Y) Straight	30	a + b + c fully loaded	10 8478 030 004 025	10 8478 030 004 049
	20	a + c fully loaded	10 8478 030 004 026	10 8478 030 004 050
	28 + 2	fully loaded + ground	10 8478 030 104 025	10 8478 030 104 049
for ≥ 2.4 mm PCB's 0.6 x 0.6 mm Post Profile 14.6 mm (Y) Straight	30	a + b + c fully loaded	10 8478 030 005 025	10 8478 030 005 049
	20	a + c fully loaded	10 8478 030 005 026	10 8478 030 005 050
	28 + 2	fully loaded + ground	10 8478 030 105 025	10 8478 030 105 049
for ≥ 2.4 mm PCB's 0.6 x 0.6 mm Post Profile 13.2 mm (Y) Straight	30	a + b + c fully loaded	10 8478 030 006 025	10 8478 030 006 049
	20	a + c fully loaded	10 8478 030 006 026	10 8478 030 006 050
	28 + 2	fully loaded + ground	10 8478 030 106 025	10 8478 030 106 049
for ≥ 2.4 mm PCB's 0.6 x 0.6 mm Post Profile 23.2 mm (Y) Straight	30	a + b + c fully loaded	10 8478 030 007 026	10 8478 030 007 049
	20	a + c fully loaded	10 8478 030 007 026	10 8478 030 007 050
	28 + 2	fully loaded + ground	10 8478 030 107 025	10 8478 030 107 049
for ≥ 2.4 mm PCB's 0.6 x 0.6 mm Post Profile 20.0 mm (Y) Straight	30	a + b + c fully loaded	10 8478 030 008 025	10 8478 030 008 049
	20	a + c fully loaded	10 8478 030 008 026	10 8478 030 008 050
	28 + 2	fully loaded + ground	10 8478 030 108 025	10 8478 030 108 049
for ≥ 2.4 mm PCB's 0.6 x 0.6 mm Post Profile 3.9 mm (Y) Straight	30	a + b + c fully loaded	10 8478 030 009 025	10 8478 030 009 049
	20	a + c fully loaded	10 8478 030 009 026	10 8478 030 009 050
	28 + 2	fully loaded + ground	10 8478 030 109 025	10 8478 030 109 049
for 1.6 mm PCB's 0.6 x 0.6 mm Post Profile 3.0 mm (Y) Straight	30	a + b + c fully loaded	10 8478 030 031 025	10 8478 030 031 049
	20	a + c fully loaded	10 8478 030 031 026	10 8478 030 031 050

NB: Alternative Prefix Variations Available: 21, 22 & 23, please refer to Page 10.
 Additional Plating & Loading Variations: Please contact your local AVX sales office or distributor.

Installed using Flat Rock method (see page 66)

LOADING DESCRIPTION

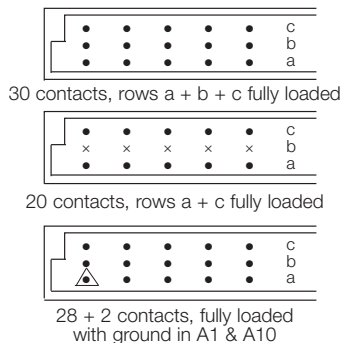

△ denotes ground pin

DIMENSIONS

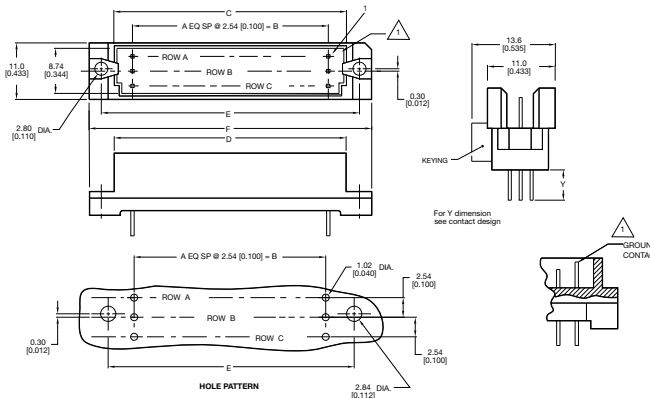

No. Contact Positions	30
Contact Rows	3 (3 x 10)
A	9
B	22.86 (0.900)
C	29.44 (1.159)
D	32.12 (1.265)
E	34.76 (1.368)
F	39.76 (1.565)

Female Style 1/2 R Press-Fit



Series 8478 – 3 rows (3 x 16) Inverted



Contact Design and Termination Length	Number of Contacts	Loading Description	Part Number Performance classes according to DIN 41612	
			II	I
for ≥ 2.4 mm PCB's 0.6 x 0.6 mm Post Profile 5.3 mm (Y) Right Angled	48	a + b + c fully loaded	20 8478 048 001 025	20 8478 048 001 049
		a + c fully loaded	20 8478 048 001 026	20 8478 048 001 050
for 1.6 mm PCB's 0.6 x 0.6 mm Post Profile 2.9 mm (Y) Right Angled	32	a + b + c fully loaded	20 8478 048 031 025	20 8478 048 031 049
		a + c fully loaded	20 8478 048 031 026	20 8478 048 031 050

NB: Alternative Prefix Variations Available: 22, please refer to Page 10.

Additional Plating & Loading Variations: Please contact your local AVX sales office or distributor.

LOADING DESCRIPTION

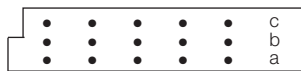

48 contacts, rows a + b + c fully loaded

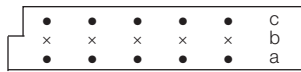

32 contacts, rows a + c fully loaded

DIMENSIONS

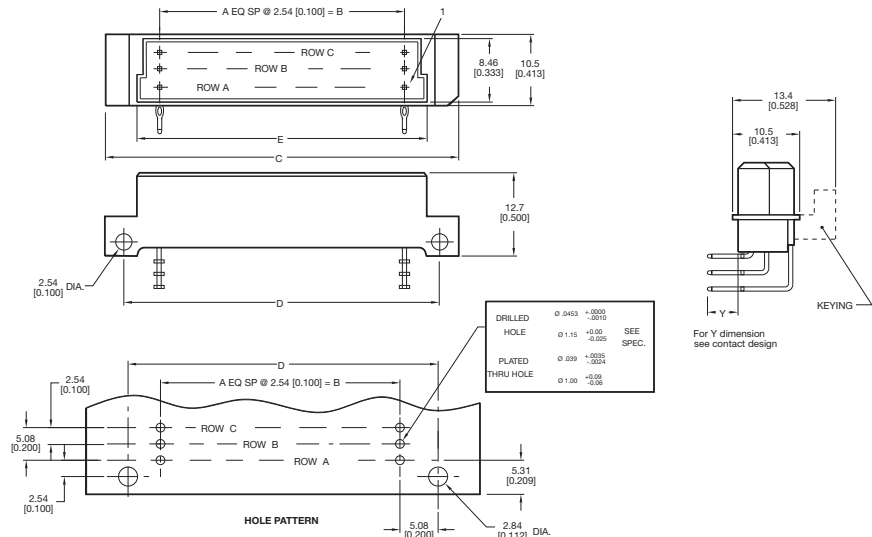

Assembly Tool: 06 8478 8471 00 000 (see page 67)

Unit: millimeters (inches)

No. Contact Positions	Contact Rows	A	B	C	D	E
48	3 (3 x 16)	31	38.10 (1.500)	53.90 (2.122)	48.26 (1.900)	44.30 (1.744)

Male Style 1/2 R Press-Fit



Series 8478 – 3 rows (3 x 16) Inverted

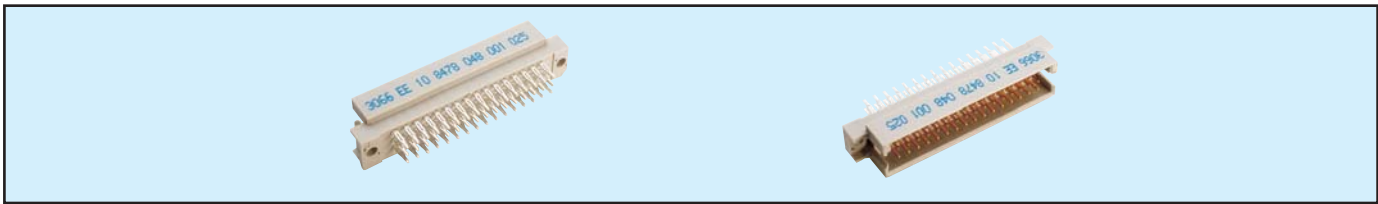

Contact Design and Termination Length	Number of Contacts	Loading Description	Part Number Performance classes according to DIN 41612	
			II	I
for ≥ 2.4 mm PCB's 0.6 x 0.6 mm Post Profile 5.3 mm (Y) Straight	48	a + b + c fully loaded	10 8478 048 001 025	10 8478 048 001 049
	32	a + c fully loaded	10 8478 048 001 026	10 8478 048 001 050
	46 + 2	fully loaded + ground	10 8478 048 101 025	10 8478 048 101 049
for ≥ 2.4 mm PCB's 0.6 x 0.6 mm Post Profile 9.3 mm (Y) Straight	48	a + b + c fully loaded	10 8478 048 002 025	10 8478 048 002 049
	32	a + c fully loaded	10 8478 048 002 026	10 8478 048 002 050
	46 + 2	fully loaded + ground	10 8478 048 102 025	10 8478 048 102 049
for ≥ 2.4 mm PCB's 0.6 x 0.6 mm Post Profile 16.2 mm (Y) Straight	48	a + b + c fully loaded	10 8478 048 003 025	10 8478 048 003 049
	32	a + c fully loaded	10 8478 048 003 026	10 8478 048 003 050
	46 + 2	fully loaded + ground	10 8478 048 103 025	10 8478 048 103 049
for ≥ 2.4 mm PCB's 0.6 x 0.6 mm Post Profile 18.2 mm (Y) Straight	48	a + b + c fully loaded	10 8478 048 004 025	10 8478 048 004 049
	32	a + c fully loaded	10 8478 048 004 026	10 8478 048 004 050
	46 + 2	fully loaded + ground	10 8478 048 104 025	10 8478 048 104 049
for ≥ 2.4 mm PCB's 0.6 x 0.6 mm Post Profile 14.6 mm (Y) Straight	48	a + b + c fully loaded	10 8478 048 005 025	10 8478 048 005 049
	32	a + c fully loaded	10 8478 048 005 026	10 8478 048 005 050
	46 + 2	fully loaded + ground	10 8478 048 105 025	10 8478 048 105 049
for ≥ 2.4 mm PCB's 0.6 x 0.6 mm Post Profile 13.2 mm (Y) Straight	48	a + b + c fully loaded	10 8478 048 006 025	10 8478 048 006 049
	32	a + c fully loaded	10 8478 048 006 026	10 8478 048 006 050
	46 + 2	fully loaded + ground	10 8478 048 106 025	10 8478 048 106 049
for ≥ 2.4 mm PCB's 0.6 x 0.6 mm Post Profile 23.2 mm (Y) Straight	48	a + b + c fully loaded	10 8478 048 007 026	10 8478 048 007 049
	32	a + c fully loaded	10 8478 048 007 026	10 8478 048 007 050
	46 + 2	fully loaded + ground	10 8478 048 107 025	10 8478 048 107 049
for ≥ 2.4 mm PCB's 0.6 x 0.6 mm Post Profile 20.0 mm (Y) Straight	48	a + b + c fully loaded	10 8478 048 008 025	10 8478 048 008 049
	32	a + c fully loaded	10 8478 048 008 026	10 8478 048 008 050
	46 + 2	fully loaded + ground	10 8478 048 108 025	10 8478 048 108 049
for ≥ 2.4 mm PCB's 0.6 x 0.6 mm Post Profile 3.9 mm (Y) Straight	48	a + b + c fully loaded	10 8478 048 009 025	10 8478 048 009 049
	32	a + c fully loaded	10 8478 048 009 026	10 8478 048 009 050
	46 + 2	fully loaded + ground	10 8478 048 109 025	10 8478 048 109 049
for 1.6 mm PCB's 0.6 x 0.6 mm Post Profile 3.0 mm (Y) Straight	48	a + b + c fully loaded	10 8478 048 031 025	10 8478 048 031 049
	32	a + c fully loaded	10 8478 048 031 026	10 8478 048 031 050

NB: Alternative Prefix Variations Available: 21, 22 & 23, please refer to Page 10.

Additional Plating & Loading Variations: Please contact your local AVX sales office or distributor.

Installed using Flat Rock method (see page 66)

LOADING DESCRIPTION DIMENSIONS

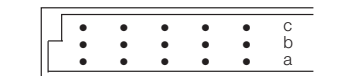

48 contacts, rows a + b + c fully loaded

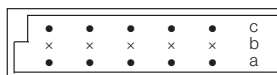

32 contacts, rows a + c fully loaded

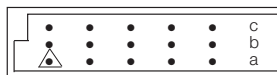

46 + 2 contacts, fully loaded with ground in A1 & A16

△ denotes ground pin

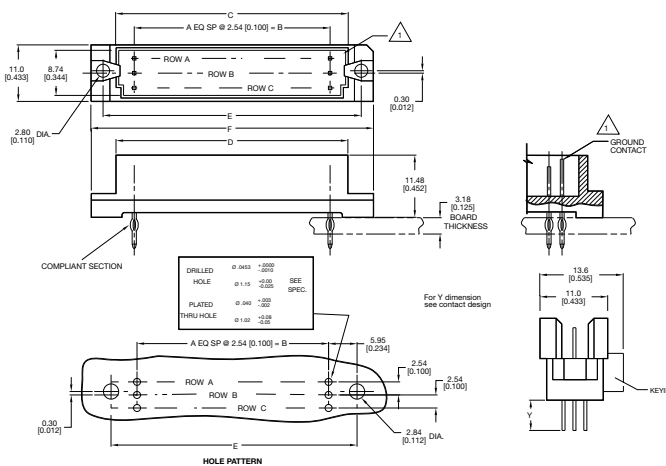

Unit: millimeters (inches)

No. Contact Positions	48
Contact Rows	3 (3 x 16)
A	15
B	38.10 (1.500)
C	44.70 (1.760)
D	47.29 (1.862)
E	50.00 (1.968)
F	54.91 (2.162)

Female Style R Press-Fit



Series 8478 – 3 rows (3 x 32) Inverted

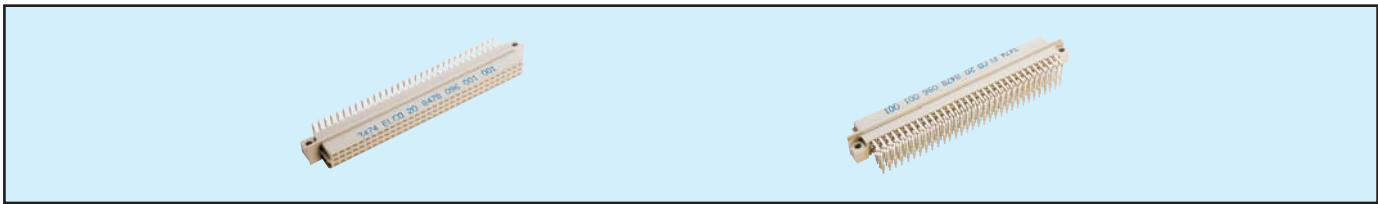

Contact Design and Termination Length	Number of Contacts	Loading Description	Part Number Performance classes according to DIN 41612	
			II	I
for ≥ 2.4 mm PCB's 0.6 x 0.6 mm Post Profile 5.3 mm Right Angled	96	a + b + c fully loaded	20 8478 096 001 025	20 8478 096 001 049
	64	a + c fully loaded	20 8478 096 001 026	20 8478 096 001 050
	32	a + c even loading	20 8478 096 001 033	20 8478 096 001 057
	32	a loading only	20 8478 096 001 027	20 8478 096 001 051
for 1.6 mm PCB's 0.6 x 0.6 mm Post Profile 2.9 mm Right Angled	96	a + b + c fully loaded	20 8478 096 031 025	20 8478 096 031 049
	64	a + c fully loaded	20 8478 096 031 026	20 8478 096 031 050
	32	a + c even loading	20 8478 096 031 033	20 8478 096 031 057
	32	a loading only	20 8478 096 031 027	20 8478 096 031 051

NB: Alternative Prefix Variations Available: 22, please refer to Page 10.

Additional Plating & Loading Variations: Please contact your local AVX sales office or distributor.

LOADING DESCRIPTION



96 contacts, rows a + b + c fully loaded

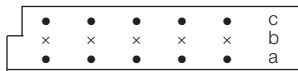

64 contacts, rows a + c fully loaded

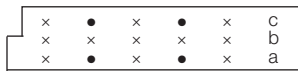

32 contacts, rows a + c even loading

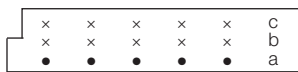

32 contacts, rows a loading only

DIMENSIONS

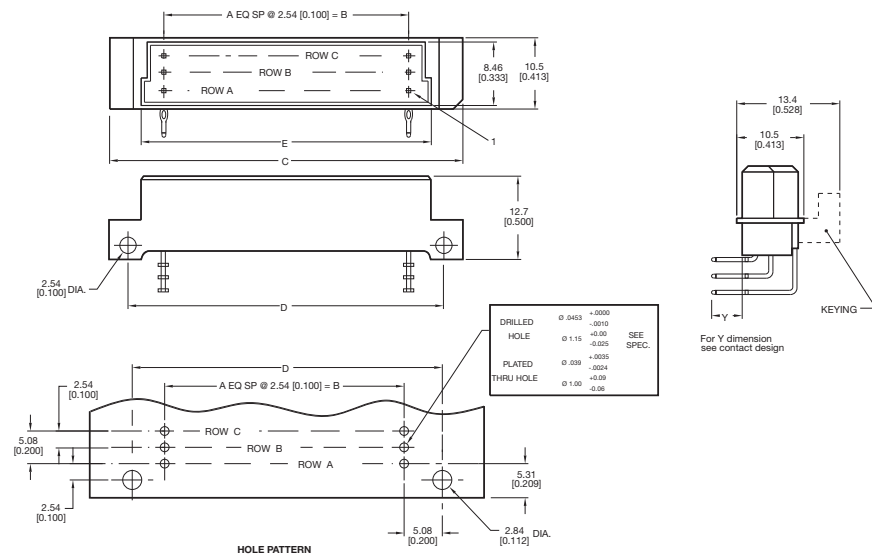

Assembly Tool: 06 8478 8471 00 000 (see page 67)

Unit: millimeters (inches)

No. Contact Positions	Contact Rows	A	B	C	D	E
96	3 (3 x 32)	31	78.74 (3.100)	93.90 (3.697)	88.90 (3.500)	84.91 (3.343)

Male Style R Press-Fit



Series 8478 – 3 rows (3 x 32) Inverted

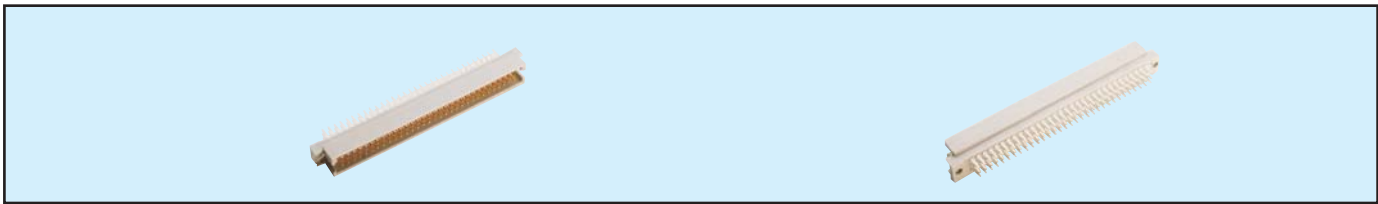

Contact Design and Termination Length	Number of Contacts	Loading Description	Part Number Performance classes according to DIN 41612	
			II	I
for ≥ 2.4 mm PCB's 0.6 x 0.6 mm Post Profile 5.3 mm (Y) Straight	96	a + b + c fully loaded	10 8478 096 001 025	10 8478 096 001 049
	64	a + c fully loaded	10 8478 096 001 026	10 8478 096 001 050
	94 + 2	fully loaded + ground	10 8478 096 101 025	10 8478 096 101 049
for ≥ 2.4 mm PCB's 0.6 x 0.6 mm Post Profile 9.3 mm (Y) Straight	96	a + b + c fully loaded	10 8478 096 002 025	10 8478 096 002 049
	64	a + c fully loaded	10 8478 096 002 026	10 8478 096 002 050
	94 + 2	fully loaded + ground	10 8478 096 102 025	10 8478 096 102 049
for ≥ 2.4 mm PCB's 0.6 x 0.6 mm Post Profile 16.2 mm (Y) Straight	96	a + b + c fully loaded	10 8478 096 003 025	10 8478 096 003 049
	64	a + c fully loaded	10 8478 096 003 026	10 8478 096 003 050
	94 + 2	fully loaded + ground	10 8478 096 103 025	10 8478 096 103 049
for ≥ 2.4 mm PCB's 0.6 x 0.6 mm Post Profile 18.2 mm (Y) Straight	96	a + b + c fully loaded	10 8478 096 004 025	10 8478 096 004 049
	64	a + c fully loaded	10 8478 096 004 026	10 8478 096 004 050
	94 + 2	fully loaded + ground	10 8478 096 104 025	10 8478 096 104 049
for ≥ 2.4 mm PCB's 0.6 x 0.6 mm Post Profile 14.6 mm (Y) Straight	96	a + b + c fully loaded	10 8478 096 005 025	10 8478 096 005 049
	64	a + c fully loaded	10 8478 096 005 026	10 8478 096 005 050
	94 + 2	fully loaded + ground	10 8478 096 105 025	10 8478 096 105 049
for ≥ 2.4 mm PCB's 0.6 x 0.6 mm Post Profile 13.2 mm (Y) Straight	96	a + b + c fully loaded	10 8478 096 006 025	10 8478 096 006 049
	64	a + c fully loaded	10 8478 096 006 026	10 8478 096 006 050
	94 + 2	fully loaded + ground	10 8478 096 106 025	10 8478 096 106 049
for ≥ 2.4 mm PCB's 0.6 x 0.6 mm Post Profile 23.2 mm (Y) Straight	96	a + b + c fully loaded	10 8478 096 007 025	10 8478 096 007 049
	64	a + c fully loaded	10 8478 096 007 026	10 8478 096 007 050
	94 + 2	fully loaded + ground	10 8478 096 107 025	10 8478 096 107 049
for ≥ 2.4 mm PCB's 0.6 x 0.6 mm Post Profile 20.0 mm (Y) Straight	96	a + b + c fully loaded	10 8478 096 008 025	10 8478 096 008 049
	64	a + c fully loaded	10 8478 096 008 026	10 8478 096 008 050
	94 + 2	fully loaded + ground	10 8478 096 108 025	10 8478 096 108 049
for ≥ 2.4 mm PCB's 0.6 x 0.6 mm Post Profile 3.9 mm (Y) Straight	96	a + b + c fully loaded	10 8478 096 009 025	10 8478 096 009 049
	64	a + c fully loaded	10 8478 096 009 026	10 8478 096 009 050
	94 + 2	fully loaded + ground	10 8478 096 109 025	10 8478 096 109 049
for 1.6 mm PCB's 0.6 x 0.6 Post Profile 3.0 mm (Y) Straight	96	a + b + c fully loaded	10 8478 096 031 025	10 8478 096 031 049
	64	a + c fully loaded	10 8478 096 031 026	10 8478 096 031 050

NB: Alternative Prefix Variations Available: 21, 22 & 23, please refer to Page 10.

Additional Plating & Loading Variations: Please contact your local AVX sales office or distributor.

Installed using Flat Rock method (see page 66)

LOADING DESCRIPTION

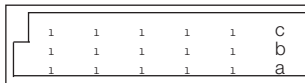

96 contacts, rows a + b + c fully loaded

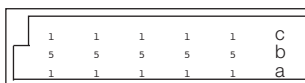

64 contacts, rows a + c fully loaded

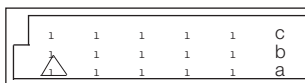

94 + 2 contacts, fully loaded with ground in A1 & A32

△ denotes ground pin

DIMENSIONS

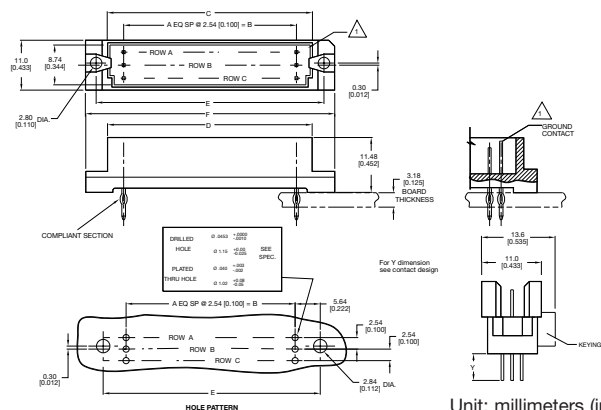

Unit: millimeters (inches)

No. Contact Positions	Contact Rows	A	B	C	D	E	F
96	3 (3 x 32)	31	78.74 (3.100)	85.29 (3.358)	87.91 (3.461)	90.0 (3.543)	94.89 (3.736)

Female Style R Expanded Press-Fit



Series 8478 – 3 rows (3 x 50) Inverted

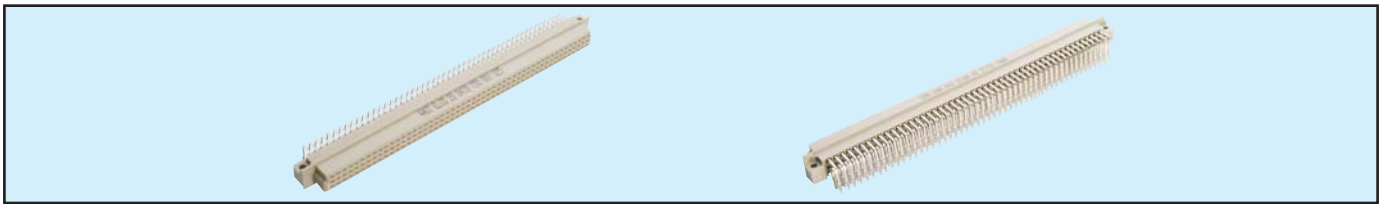

Contact Design and Termination Length	Number of Contacts	Loading Description	Part Number Performance classes according to DIN 41612	
			II	I
for ≥ 2.4 mm PCB's 0.6 x 0.6 mm Post Profile 5.3 mm (Y) Right Angled	150	a + b + c fully loaded	20 8478 150 001 025	20 8478 150 001 049
	100	a + c fully loaded	20 8478 150 001 026	20 8478 150 001 050
for 1.6 mm PCB's 0.6 x 0.6 mm Post Profile 2.9 mm (Y) Right Angled	150	a + b + c fully loaded	20 8478 150 031 025	20 8478 150 031 049
	100	a + c fully loaded	20 8478 150 031 026	20 8478 150 031 050

NB: Alternative Prefix Variations Available: 22, please refer to Page 10.

Additional Plating & Loading Variations: Please contact your local AVX sales office or distributor.

LOADING DESCRIPTION

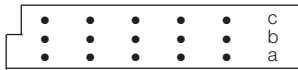

150 contacts, rows a + b + c fully loaded

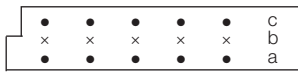

100 contacts, rows a + c fully loaded

DIMENSIONS

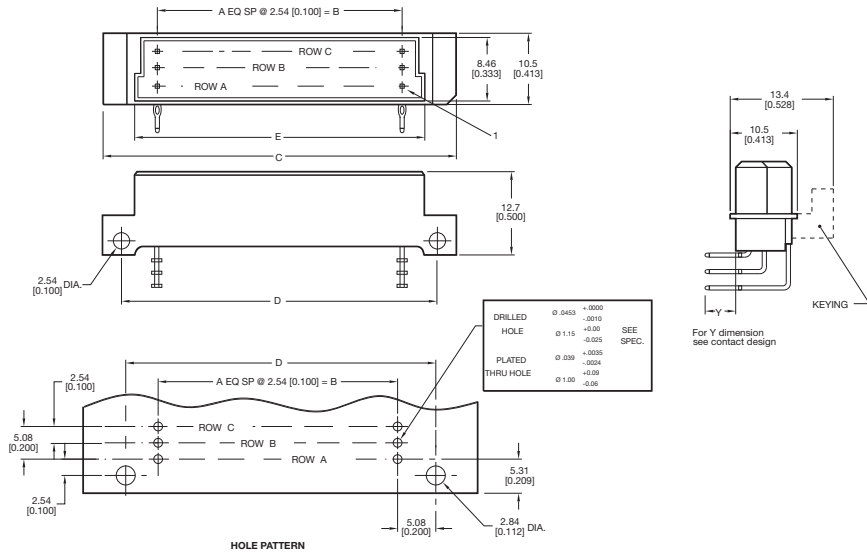

Assembly Tool: 06 8478 8401 00 000 (see page 67)

Unit: millimeters (inches)

No. Contact Positions	Contact Rows	A	B	C	D	E
150	3 (3 x 50)	49	124.46 (4.900)	139.70 (5.500)	134.62 (5.300)	130.70 (5.145)

Female Style R Expanded Press-Fit



Series 8478 – 4 rows (4 x 32) Inverted

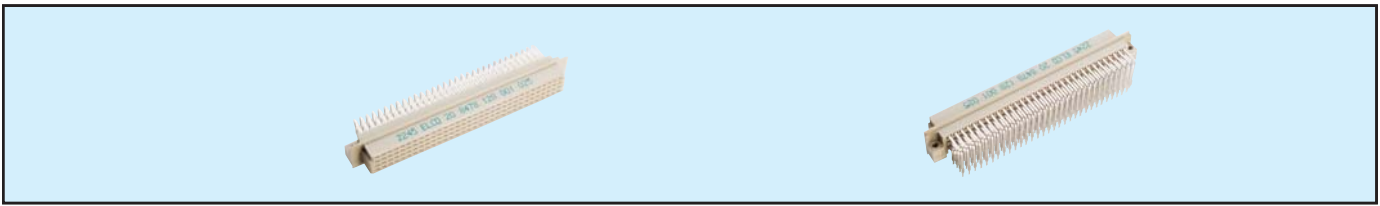

Contact Design and Termination Length	Number of Contacts	Loading Description	Part Number Performance classes according to DIN 41612	
			II	I
for ≥ 2.4 mm PCB's 0.6 x 0.6 mm Post Profile 5.3 mm (Y) Right Angled	128	a + b + c + d fully loaded	20 8478 128 001 025	20 8478 128 001 049
for 1.6 mm PCB's 0.6 x 0.6 mm Post Profile 2.9 mm (Y) Right Angled	128	a + b + c + d fully loaded	20 8478 128 031 025	20 8478 128 031 049

NB: Alternative Prefix Variations Available: 22, please refer to Page 10.

Additional Plating & Loading Variations: Please contact your local AVX sales office or distributor.

LOADING DESCRIPTION

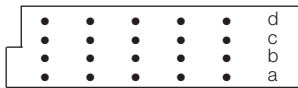

128 contacts,
rows a + b + c + d fully loaded

DIMENSIONS

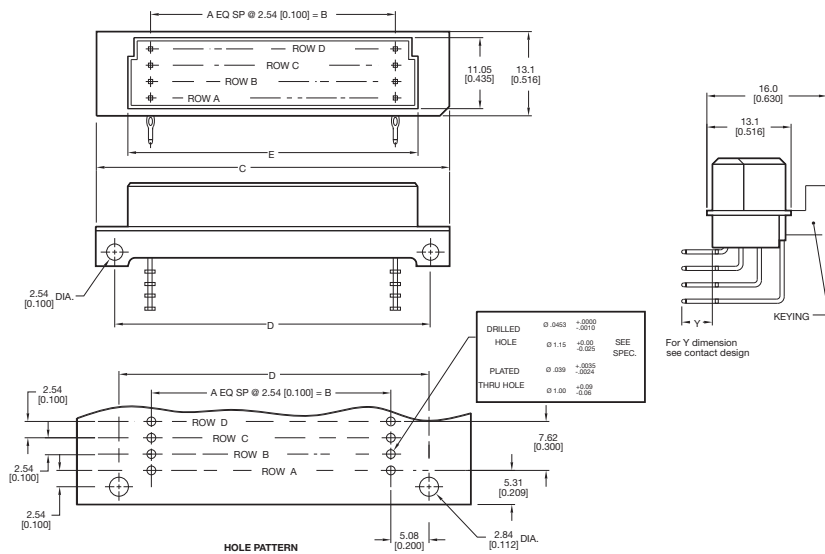

Assembly Tool: 06 8478 8481 00 000 (see page 67)

Unit: millimeters (inches)

No. Contact Positions	Contact Rows	A	B	C	D	E
128	4 (4 x 32)	31	78.74 (3.100)	93.90 (3.697)	88.90 (3.500)	84.91 (3.343)

Male Style R Expanded Press-Fit



Series 8478 – 4 rows (4 x 32) Inverted

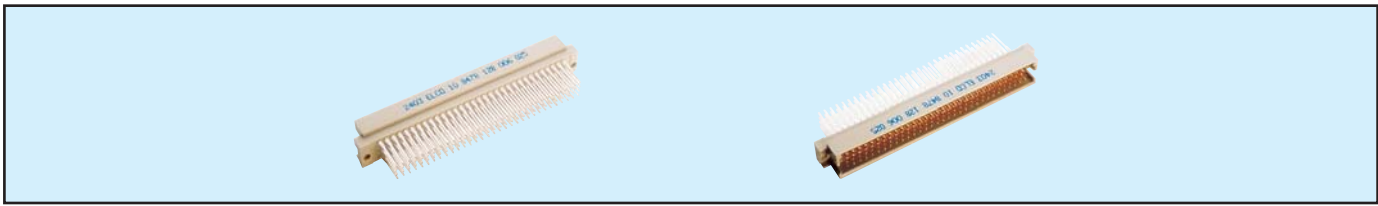

Contact Design and Termination Length	Number of Contacts	Loading Description	Part Number Performance classes according to DIN 41612	
			II	I
for ≥ 2.4 mm PCB's 0.6 x 0.6 mm Post Profile 5.3 mm (Y) Straight	128	a + b + c + d fully loaded	10 8478 128 001 025	10 8478 128 001 049
	126 + 2	fully loaded + ground	10 8478 128 101 025	10 8478 128 101 049
for ≥ 2.4 mm PCB's 0.6 x 0.6 mm Post Profile 9.3 mm (Y) Straight	128	a + b + c + d fully loaded	10 8478 128 002 025	10 8478 128 002 049
	126 + 2	fully loaded + ground	10 8478 128 102 025	10 8478 128 102 049
for ≥ 2.4 mm PCB's 0.6 x 0.6 mm Post Profile 16.2 mm (Y) Straight	128	a + b + c + d fully loaded	10 8478 128 003 025	10 8478 128 003 049
	126 + 2	fully loaded + ground	10 8478 128 103 025	10 8478 128 103 049
for ≥ 2.4 mm PCB's 0.6 x 0.6 mm Post Profile 18.2 mm (Y) Straight	128	a + b + c + d fully loaded	10 8478 128 004 025	10 8478 128 004 049
	126 + 2	fully loaded + ground	10 8478 128 104 025	10 8478 128 104 049
for ≥ 2.4 mm PCB's 0.6 x 0.6 mm Post Profile 14.6 mm (Y) Straight	128	a + b + c + d fully loaded	10 8478 128 005 025	10 8478 128 005 049
	126 + 2	fully loaded + ground	10 8478 128 105 025	10 8478 128 105 049
for ≥ 2.4 mm PCB's 0.6 x 0.6 mm Post Profile 13.2 mm (Y) Straight	128	a + b + c + d fully loaded	10 8478 128 006 025	10 8478 128 006 049
	126 + 2	fully loaded + ground	10 8478 128 106 025	10 8478 128 106 049
for ≥ 2.4 mm PCB's 0.6 x 0.6 mm Post Profile 23.2 mm (Y) Straight	128	a + b + c + d fully loaded	10 8478 128 007 025	10 8478 128 007 049
	126 + 2	fully loaded + ground	10 8478 128 107 025	10 8478 128 107 049
for ≥ 2.4 mm PCB's 0.6 x 0.6 mm Post Profile 20.0 mm (Y) Straight	128	a + b + c + d fully loaded	10 8478 128 008 025	10 8478 128 008 049
	126 + 2	fully loaded + ground	10 8478 128 108 025	10 8478 128 108 049
for ≥ 2.4 mm PCB's 0.6 x 0.6 mm Post Profile 3.9 mm (Y) Straight	128	a + b + c + d fully loaded	10 8478 128 009 025	10 8478 128 009 049
	126 + 2	fully loaded + ground	10 8478 128 109 025	10 8478 128 109 049
for 1.6 mm PCB's 0.6 x 0.6 mm Post Profile 3.0 mm (Y) Straight	128	a + b + c + d fully loaded	10 8478 128 031 025	10 8478 128 031 049
	126 + 2	fully loaded + ground	10 8478 128 131 025	10 8478 128 131 049

NB: Alternative Prefix Variations Available: 21, 22 & 23, please refer to Page 10.
Additional Plating & Loading Variations: Please contact your local AVX sales office or distributor.

Installed using Flat Rock method (see page 66)

LOADING DESCRIPTION

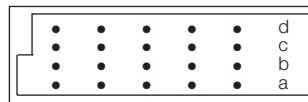

128 contacts, rows a + b + c + d fully loaded

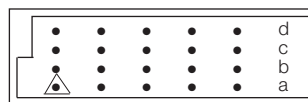

126 + 2 contacts, fully loaded with ground in A1 & A30

△ denotes ground pin

DIMENSIONS

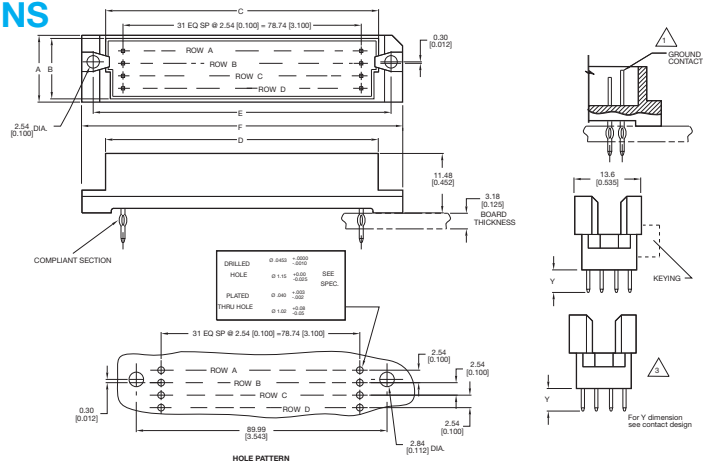

Unit: millimeters (inches)

No. Contact Positions	Contact Rows	A	B	C	D	E	F
128	4 (4 x 32)	13.60 (0.535)	11.28 (0.444)	85.29 (3.358)	87.88 (3.460)	89.90 (3.539)	94.89 (3.736)

Female Style R Expanded Press-Fit



Series 8478 – 5 rows (5 x 32) Inverted

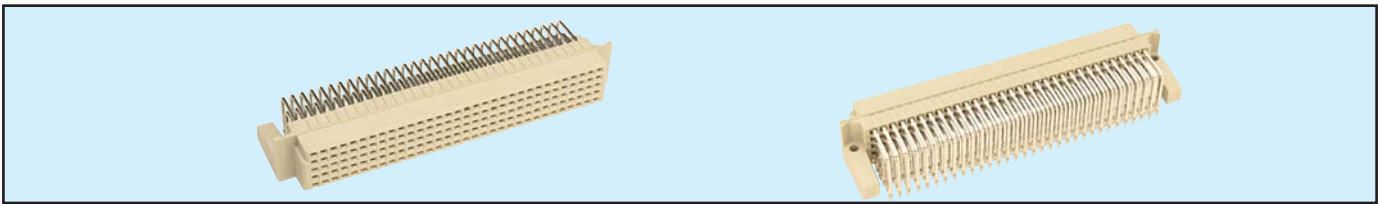

Contact Design and Termination Length	Number of Contacts	Loading Description	Part Number	
			Performance classes according to DIN 41612 II	I
for ≥ 2.4 mm PCB's 0.6 x 0.6 mm Post Profile 5.3 mm (Y) Right Angled	160	a + b + c + d + e fully loaded	20 8478 160 001 025	20 8478 160 001 049
			please contact your local AVX sales office	
for 1.6 mm PCB's 0.6 x 0.6 mm Post Profile 2.9 mm (Y) Right Angled	160	a + b + c + d + e fully loaded	20 8478 160 031 025	20 8478 160 031 049
			please contact your local AVX sales office	

NB: Alternative Prefix Variations Available: 22, please refer to Page 10.

Additional Plating & Loading Variations: Please contact your local AVX sales office or distributor.

LOADING DESCRIPTION

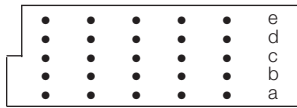

160 contacts,
rows a + b + c + d + e fully loaded

DIMENSIONS

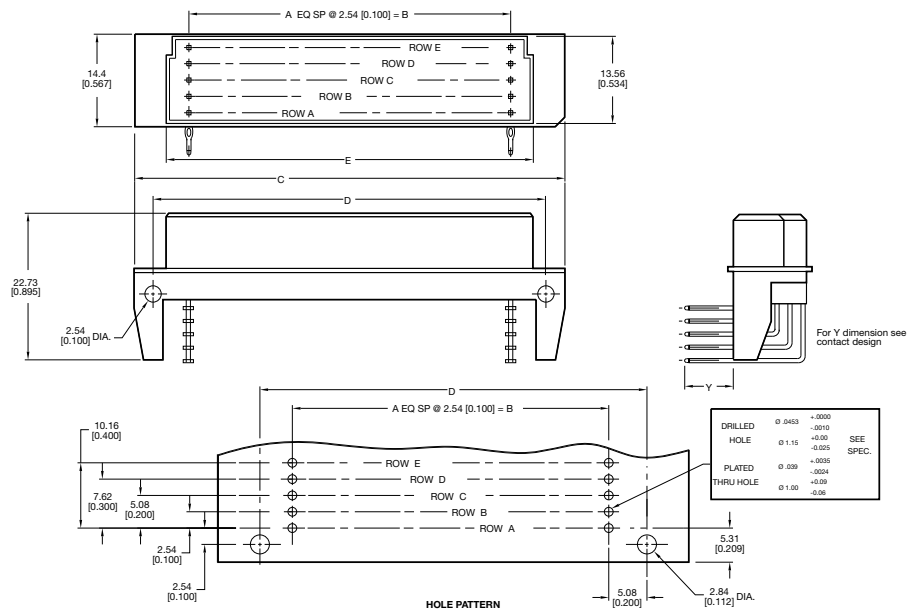

Assembly Tool: 06 8478 8491 00 000 (see page 67)

Unit: millimeters (inches)

No. Contact Positions	Contact Rows	A	B	C	D	E
160	5 (5 x 32)	31	78.74 (3.100)	94.00 (3.700)	88.90 (3.500)	85.00 (3.346)

Male Style R Expanded Press-Fit



Series 8478 – 5 rows (5 x 32) Inverted

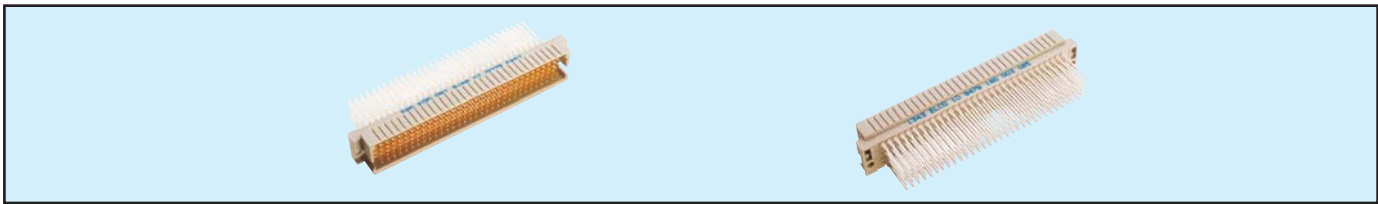

Contact Design and Termination Length	Number of Contacts	Loading Description	Part Number Performance classes according to DIN 41612	
			II	I
for ≥ 2.4 mm PCB's 0.6 x 0.6 mm Post Profile 5.3 mm (Y) Straight	160	a + b + c + d + e fully loaded	10 8478 160 001 025	10 8478 160 001 049
	158 + 2	fully loaded + ground	10 8478 160 101 025	10 8478 160 101 049
for ≥ 2.4 mm PCB's 0.6 x 0.6 mm Post Profile 9.3 mm (Y) Straight	160	a + b + c + d + e fully loaded	10 8478 160 002 025	10 8478 160 002 049
	158 + 2	fully loaded + ground	10 8478 160 102 025	10 8478 160 102 049
for ≥ 2.4 mm PCB's 0.6 x 0.6 mm Post Profile 16.2 mm (Y) Straight	160	a + b + c + d + e fully loaded	10 8478 160 003 025	10 8478 160 003 049
	158 + 2	fully loaded + ground	10 8478 160 103 025	10 8478 160 103 049
for ≥ 2.4 mm PCB's 0.6 x 0.6 mm Post Profile 18.2 mm (Y) Straight	160	a + b + c + d + e fully loaded	10 8478 160 004 025	10 8478 160 004 049
	158 + 2	fully loaded + ground	10 8478 160 104 025	10 8478 160 104 049
for ≥ 2.4 mm PCB's 0.6 x 0.6 mm Post Profile 13.2 mm (Y) Straight	160	a + b + c + d + e fully loaded	10 8478 160 006 025	10 8478 160 006 049
	158 + 2	fully loaded + ground	10 8478 160 106 025	10 8478 160 106 049
for ≥ 2.4 mm PCB's 0.6 x 0.6 mm Post Profile 23.2 mm (Y) Straight	160	a + b + c + d + e fully loaded	10 8478 160 007 025	10 8478 160 007 049
	158 + 2	fully loaded + ground	10 8478 160 107 025	10 8478 160 107 049
for ≥ 2.4 mm PCB's 0.6 x 0.6 mm Post Profile 20.0 mm (Y) Straight	160	a + b + c + d + e fully loaded	10 8478 160 008 025	10 8478 160 008 049
	158 + 2	fully loaded + ground	10 8478 160 108 025	10 8478 160 108 049
for ≥ 2.4 mm PCB's 0.6 x 0.6 mm Post Profile 3.9 mm (Y) Straight	160	a + b + c + d + e fully loaded	10 8478 160 009 025	10 8478 160 009 049
	158 + 2	fully loaded + ground	10 8478 160 109 025	10 8478 160 109 049
for 1.6 mm PCB's 0.6 x 0.6 mm Post Profile 3.0 mm (Y) Straight	160	a + b + c + d fully loaded	10 8478 160 031 025	10 8478 160 031 049
	158 + 2	fully loaded + ground	10 8478 160 131 025	10 8478 160 131 049

NB: Alternative Prefix Variations Available: 21, 22 & 23, please refer to Page 10.

Additional Plating & Loading Variations: Please contact your local AVX sales office or distributor.

Installed using Flat Rock method (see page 66)

LOADING DESCRIPTION

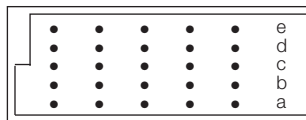

160 contacts,
rows a + b + c + d + e fully loaded

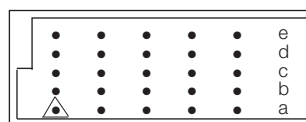

158 + 2 contacts, fully loaded
with ground in A1 & A32

△ denotes ground pin

DIMENSIONS

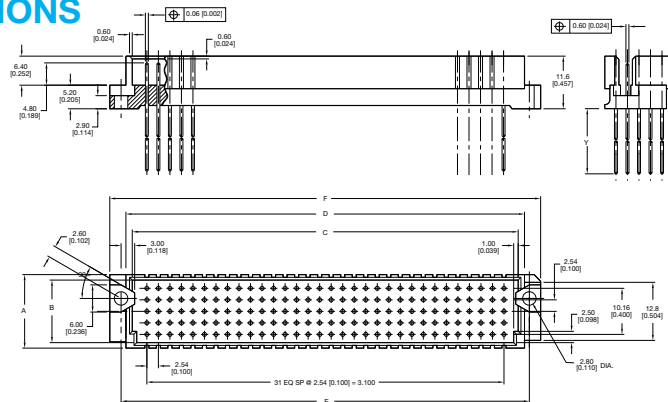

Unit: millimeters (inches)

No. Contact Positions	Contact Rows	A	B	C	D	E	F
160	5 (5 x 32)	16.20 (0.638)	13.80 (0.543)	85.29 (3.358)	87.88 (3.460)	89.90 (3.539)	94.89 (3.736)

Mouser Electronics

Authorized Distributor

Click to View Pricing, Inventory, Delivery & Lifecycle Information:

AVX:

[108478048008049](#) [108478048006026](#) [108478128031025](#) [108478160001025](#) [208478096001025](#)
[598478048000009](#) [108478030001026](#) [108478048001025](#) [108478096002025](#) [108478096101025](#) [208478096031025](#)
[598478048000007](#) [108478032001025](#) [108478048001026](#) [108478048031025](#) [108478048031049](#)
[108478064001025](#) [108478064031025](#) [108478096001026](#) [108478096001037](#) [108478096006025](#) [108478096009025](#)
[108478096031026](#) [108478128001025](#) [108478128006025](#) [108478160002025](#) [108478160003025](#)
[108478160005025](#) [108478160009025](#) [108478160031025](#) [108478160101025](#) [128478096002049](#) [208478048031025](#)
[208478064031025](#) [208478096031049](#) [208478160031025](#) [108478064001001](#) [108478096006097](#)
[598478048000016](#) [598478048000015](#)