

THIS DOCUMENT IS THE PROPERTY OF
KEYSTONE ELECTRONICS CORP. AND
SHALL NOT BE REPRODUCED, DISTRIBUTED
OR USED AS A BASIS FOR MANUFACTURE
WITHOUT PRIOR WRITTEN PERMISSION
FROM KEYSTONE ELECTRONICS CORP.

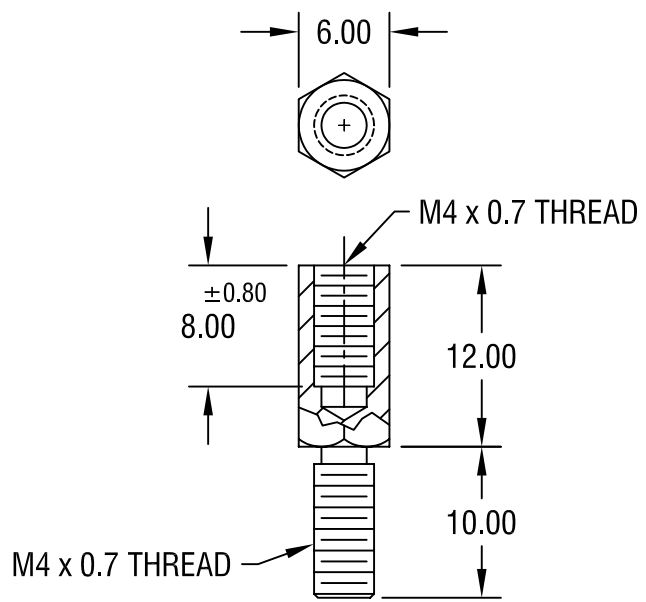

NOTE:

1. ALL DIMENSIONS ARE IN MILLIMETERS

KEYSTONE ELECTRONICS CORP.			
ASTORIA, N.Y. 11105-2017			
PART NAME		6.0mm M/F HEX STANDOFF	
MATERIAL		STAINLESS STEEL	
FINISH	-	DRN BY BOONE	DATE 5.8.06
		APP'D LN	SCALE 2X
TOLERANCES	INCH [MM]	CODE	DWG NO.
DECIMAL	± [± 0.15]	C/M	24302
ANGULAR	± 1°		
UNLESS OTHERWISE SPECIFIED			

DATE	DESCRIPTION	REV.