

# PSI-MOS-RS485W2/FO1300 E

Order No.: 2708562



<http://eshop.phoenixcontact.de/phoenix/treeViewClick.do?UID=2708562>

FO converter with integrated optical diagnostics, alarm contact, for RS-485 2-wire bus systems (SUCONET K, MODBUS ...) up to 500 kbps, NRZ coding, termination device with an FO interface (SC-Duplex), 1300 nm, for glass fiber cable

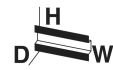

Commercial data	
GTIN (EAN)	 4 046356 176279
sales group	H622
Pack	1 pcs.
Customs tariff	85176200
Catalog page information	Page 507 (IF-2009)

**Product notes**

WEEE/RoHS-compliant since:  
07/31/2007



<http://www.download.phoenixcontact.com>  
Please note that the data given here has been taken from the online catalog. For comprehensive information and data, please refer to the user documentation. The General Terms and Conditions of Use apply to Internet downloads.

Technical data	
<b>Serial interface</b>	
Interface 1	RS-485 interface, 2-wire
Operating mode	Semi-duplex
File format/coding	UART (11/10 bit switchable; NRZ), slip-tolerant

Data direction switching	Automatic control
Termination resistor	220 $\Omega$ can be connected; pull up/down 390 $\Omega$
Transmission length	max. 1200 m (depending on the data rate, with shielded, twisted data cable)
Connection method	Pluggable screw connection
Serial transmission speed	4,8/ 9,6/ 19,2/ 38,4/ 57,6/ 75/ 93,75/ 115,2/ 136/ 187,5/ 375/ 500

#### Optical interface FO

Wavelength	1300 nm
Transmission length incl. 3 dB system reserve	25 km (With F-G 50/125 0.7 dB/km at 1300 nm) 22 km (with F-G 62.5/125 0.8 dB/km at 1300 nm) 45 km (With F-E 9/125 0,4 dB/km at 1300 nm)
Transmission protocol	Protocol-transparent to the RS-485 interface
Connection method	SC duplex

#### Fault warning output

Maximum switching voltage	60 V DC 42 V AC
Limiting continuous current	1 A

#### Power supply

Nominal supply voltage	24 V DC $\pm$ 25%
Supply voltage range	18 V DC ... 32 V DC
Typical current consumption	110 mA (24 V DC)
Connection method	COMBICON plug-in screw terminal block

#### General data

Bit distortion, input	$\pm$ 35 % (permitted)
Bit distortion, output	< 6.25 %
Width	35 mm
Height	99 mm
Depth	105 mm
Ambient temperature (storage/transport)	-40 $^{\circ}$ C ... 85 $^{\circ}$ C
Ambient temperature (operation)	-20 $^{\circ}$ C ... 60 $^{\circ}$ C
Electrical isolation	(VCC // RS-485)
Test voltage data interface/power supply	1.5 kV <sub>rms</sub> (50 Hz, 1 min.)
Electromagnetic compatibility	Conformance with EMC directive 89/336/EC
Noise emission	EN 55011

Noise immunity	EN 61000-6-2:2005
Degree of protection	IP20
Housing material	PA V0, color green
Color	green
MTBF	484 Years (Telcordia standard, 25°C temperature, 21% operating cycle (5 days a week, 8 hours a day))
	102 Years (Telcordia standard, 40°C temperature, 34.25% operating cycle (5 days a week, 12 hours a day))
ATEX	Ex II 3 G Ex nAC IIC T4 X
UL, USA / Canada	cUL 508 Recognized

### Certificates / Approvals



Certification CUL, UL

### Accessories

Item	Designation	Description
<b>Cable/conductor</b>		
2989161	FL MM PATCH 1,0 LC-SC	Assembled fiber optic cable, break-out cable, glass fiber multi-mode 50/125 µm, connector: LC/SC duplex, degree of protection: IP20, for installation in cable ducts or control cabinets, length: 1 meter
2901805	FL MM PATCH 1,0 SC-SC	Assembled FO cable, break out cable, multi-mode glass fiber 50/125 µm, connector: SC Duplex / SC-Duplex, protection type: IP20, for installation in cable ducts or control cabinets, length: 1 meter
2901812	FL MM PATCH 1,0 SC-SCRJ	Assembled FO cable, break out cable, multi-mode glass fiber 50/125 µm, connector: SC Duplex / B-FOC (ST), protection type: IP20, for installation in cable ducts or control cabinets, length: 1 meter
2901809	FL MM PATCH 1,0 SC-ST	Assembled FO cable, break out cable, multi-mode glass fiber 50/125 µm, connector: SC Duplex / B-FOC, protection type: IP20, for installation in cable ducts or control cabinets, length: 1 meter
2989268	FL MM PATCH 2,0 LC-SC	Assembled fiber optic cable, break-out cable, glass fiber multi-mode 50/125 µm, connector: LC/SC duplex, degree of protection: IP20, for installation in cable ducts or control cabinets, length: 2 meter

2901807	FL MM PATCH 2,0 SC-SC	Assembled FO cable, break out cable, multi-mode glass fiber 50/125 µm, connector: SC Duplex / SC-Duplex, protection type: IP20, for installation in cable ducts or control cabinets, length: 2 meters
2901813	FL MM PATCH 2,0 SC-SCRJ	Assembled FO cable, break out cable, multi-mode glass fiber 50/125 µm, connector: SC Duplex / SCRJ, protection type: IP20, for installation in cable ducts or control cabinets, length: 2 meters
2901810	FL MM PATCH 2,0 SC-ST	Assembled FO cable, break out cable, multi-mode glass fiber 50/125 µm, connector: SC Duplex / B-FOC (ST), protection type: IP20, for installation in cable ducts or control cabinets, length: 2 meters
2901800	FL MM PATCH 5,0 LC-SC	Assembled FO cable, break out cable, multi-mode glass fiber 50/125 µm, plug: LC / SC-Duplex, protection type: IP20, for installation in cable ducts or control cabinets, length: 5 meters
2901808	FL MM PATCH 5,0 SC-SC	Assembled FO cable, break out cable, multi-mode glass fiber 50/125 µm, connector: SC Duplex / SC-Duplex, protection type: IP20, for installation in cable ducts or control cabinets, length: 5 meters
2901814	FL MM PATCH 5,0 SC-SCRJ	Assembled FO cable, break out cable, multi-mode glass fiber 50/125 µm, connector: SC Duplex / B-FOC (ST), protection type: IP20, for installation in cable ducts or control cabinets, length: 5 meters
2901811	FL MM PATCH 5,0 SC-ST	Assembled FO cable, break out cable, multi-mode glass fiber 50/125 µm, connector: SC Duplex / B-FOC (ST), protection type: IP20, for installation in cable ducts or control cabinets, length: 5 meters
2989190	FL SM PATCH 1,0 LC-SC	Assembled fiber optic cable, break-out cable, glass fiber single mode 9/125 µm, connector: LC/SC duplex, degree of protection: IP20, for installation in cable ducts or control cabinets, length: 1 meter
2901829	FL SM PATCH 1,0 SC-SC	Assembled FO cable, break out cable, single-mode glass fiber 9/125 µm, connector: SC Duplex / SC-Duplex, protection type: IP20, for installation in cable ducts or control cabinets, length: 1 meter
2901832	FL SM PATCH 1,0 SC-ST	Assembled FO cable, break out cable, single-mode glass fiber 9/125 µm, connector: SC Duplex / B-FOC (ST), protection type: IP20, for installation in cable ducts or control cabinets, length: 1 meter
2989297	FL SM PATCH 2,0 LC-SC	Assembled fiber optic cable, break-out cable, glass fiber single mode 9/125 µm, connector: LC/SC duplex, degree of protection: IP20, for installation in cable ducts or control cabinets, length: 2 meters
2901830	FL SM PATCH 2,0 SC-SC	Assembled FO cable, break out cable, single-mode glass fiber 9/125 µm, connector: SC Duplex / SC-Duplex, protection type: IP20, for installation in cable ducts or control cabinets, length: 2 meters

2901833	FL SM PATCH 2,0 SC-ST	Assembled FO cable, break out cable, single-mode glass fiber 9/125 µm, connector: SC Duplex / B-FOC (ST), protection type: IP20, for installation in cable ducts or control cabinets, length: 2 meters
2901827	FL SM PATCH 5,0 LC-SC	Assembled FO cable, break out cable, single-mode glass fiber 9/125 µm, connector: LC / SC Duplex, protection type: IP20, for installation in cable ducts or control cabinets, length: 5 meters
2901831	FL SM PATCH 5,0 SC-SC	Assembled FO cable, break out cable, single-mode glass fiber 9/125 µm, connector: SC Duplex / SC-Duplex protection type: IP20, for installation in cable ducts or control cabinets, length: 5 meters
2901834	FL SM PATCH 5,0 SC-ST	Assembled FO cable, break out cable, single-mode glass fiber 9/125 µm, connector: SC Duplex / B-FOC (ST), protection type: IP20, for installation in cable ducts or control cabinets, length: 5 meters
1402193	FOC-GDM-RUGGED-1016/...	rugged GOF installation cable for inner areas with highly tear-proof aramid strain-relief elements. Individual elements consist of highly flexible FRNC material. The cable is halogen-free, ozone and UV resistant and has a rugged polyurethane (PUR) outer sheath.
2901558	FOC-GDM-RUGGED-1016/IP20/...	rugged GOF installation cable (IP20 heads only) for inner areas with highly tear-proof aramid strain-relief elements. Individual elements consist of highly flexible FRNC material. The cable is halogen-free, ozone and UV resistant and has a rugged polyurethane (PUR) outer sheath.
1402194	FOC-GDO-1017/...	Highly rugged GOF round cable for assembly and for outdoor installation with integrated moisture barrier as well as rodent-proof scrim. Individual elements made from highly flexible FRNC material. The wire is ozone and UV resistant with a very rugged polyethylene outer sheath.
2901559	FOC-GDO-1017/IP20/...	Highly rugged GOF round cable (IP20 heads only) for assembly and for outdoor installation with integrated moisture barrier as well as rodent-proof scrim. Individual elements made from highly flexible FRNC material. The wire is ozone and UV resistant with a very rugged polyethylene outer sheath.
2799322	PSM-LWL-GDM-RUGGED-50/125	Glass fiber cable, duplex 50/125 µm, by the meter, without connector, for indoor installation
2799432	PSM-LWL-GDO- 50/125	Glass fiber cable, duplex 50/125 µm, by the meter, without connector, for outdoor installation
<b>General</b>		
2313944	PSI-TERMINATOR-PB	Active termination resistor with redundant voltage supply for PROFIBUS and RS-485 bus systems. Compact design. Electrical isolation between supply and data interface. Bus termination can be switched. Integrated programming interface.

Diagrams/Drawings

Application drawing

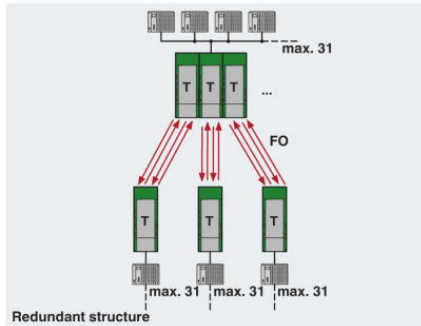
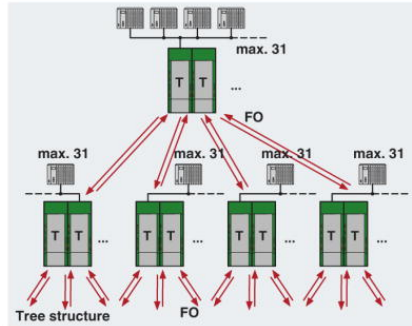
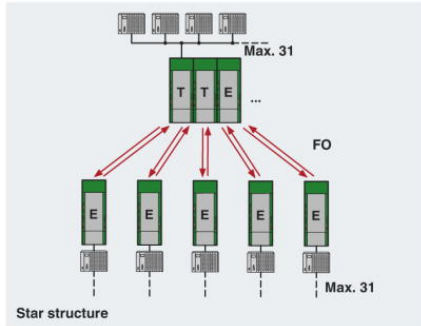
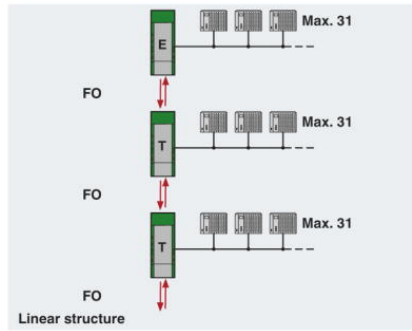
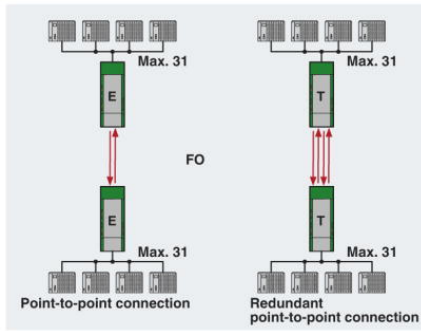

Block diagram

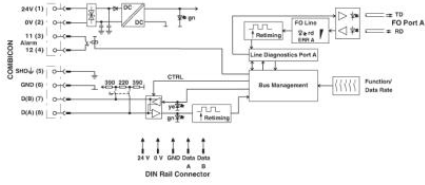

**Address**

PHOENIX CONTACT Inc., USA  
586 Fulling Mill Road  
Middletown, PA 17057, USA  
Phone (800) 888-7388  
Fax (717) 944-1625  
<http://www.phoenixcon.com>



© 2011 Phoenix Contact  
Technical modifications reserved;