

REVISIONS		REVISED BY	DATE	APPR
SYM	DESCRIPTION			

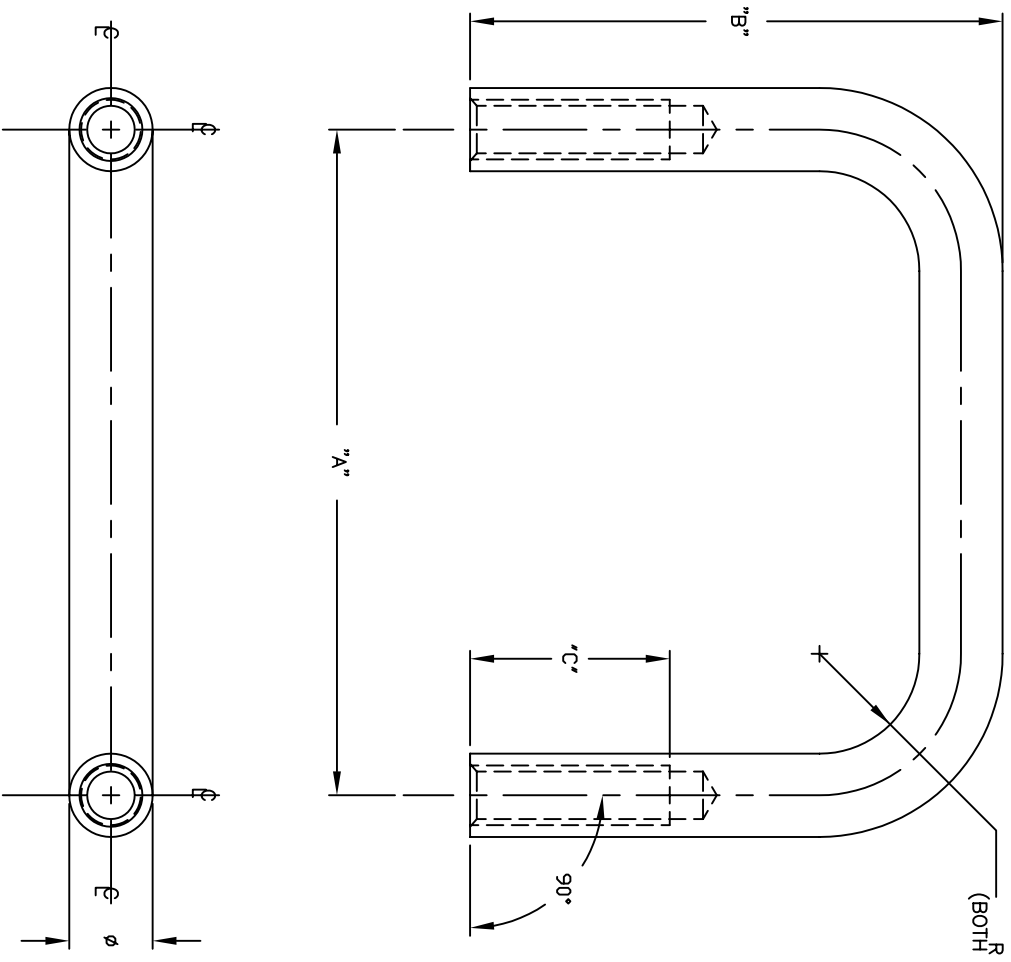

PART#	MAT.	FINISH	HEIGHT	RADIUS	MNT CENTER	THD & DEPTH
			"B"	"R"	"A"	"C"
5/32 DIAMETER						
1633	BRASS	BLK ZINC	1"	3/16"	2"	4-40x3/8"
1632		CHROME				
1634	ALUMINUM	SATIN				
1635		BLK ANODIZED				
1637	BRASS	BLK ZINC	1"	3/16"	2"	4-40x3/8"
1636		CHROME				
1638	ALUMINUM	SATIN				
1639		BLK ANODIZED				
1641	BRASS	BLK ZINC	1"	3/16"	2"	4-40x3/8"
1640		CHROME				
1642	ALUMINUM	SATIN				
1643		BLK ANODIZED				
1/4 DIAMETER						
1617		BLK ZINC	1-1/2"	1/4"	2"	8-32x9/16"
1616		CHROME				
1621	BRASS	BLK ZINC				
1620		CHROME	1-1/2"	1/4"	2"	8-32x9/16"
2057	BRASS	CHROME				
1604		BLK ZINC				
2056		CHROME	5/16 DIAMETER			
			1-1/2"	5/16"	3"	10-32x9/16"

MATERIAL: "SEE TABLE"		FINISH: "SEE TABLE"	
DIMENSIONAL TOLERANCES UNLESS OTHERWISE SPECIFIED			
XX	XXX	XXXX	
---	---	---	
FRACTIONS	ANGLES	SCALE	
---	---	4:1	
HEAT TREAT:	---		
PLOT SCALE:	1=1		
DRAWN: E. MCKINNEY DATE: 02-17-92		SIZE: DRAWING NUMBER	
CHECKED: E. MCKINNEY DATE: 02-17-92		B SD: HANDLES	
APPROVED: D. MILLER DATE: 02-17-92		E	
ABBATRON Electronic Connectors and Hardware 13680 S. MOSERTOWN RD MEADVILLE, PA 16335			