

Electronic housing - ME 17,5 TBUS 1,5/ 5-ST-3,81 KM - 2713645

Please be informed that the data shown in this PDF Document is generated from our Online Catalog. Please find the complete data in the user's documentation. Our General Terms of Use for Downloads are valid (<http://phoenixcontact.com/download>)

Plug component, Nominal current: 8 A, Number of positions: 5, Pitch: 3.81 mm

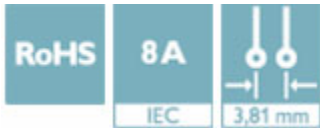

Key Commercial Data

Packing unit	1 STK
Weight per Piece (excluding packing)	4.930 g
Custom tariff number	85366990
Country of origin	Germany

Technical data

Dimensions

Pitch	3.81 mm
Width	3.5 mm
Constructional height	7.5 mm

General

Rated voltage (III/3)	125 V
Nominal current I_N	8 A
Maximum load current	8 A
Flammability rating according to UL 94	V0
Number of positions	5

Standards and Regulations

Connection in acc. with standard	CUL
Flammability rating according to UL 94	V0

Environmental Product Compliance

Electronic housing - ME 17,5 TBUS 1,5/ 5-ST-3,81 KM - 2713645

Technical data

Environmental Product Compliance

China RoHS	Environmentally friendly use period: unlimited = EFUP-e
	No hazardous substances above threshold values

Drawings

Dimensional drawing

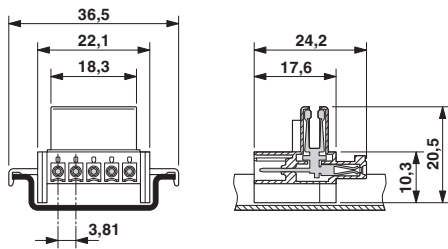

Dimensional drawing

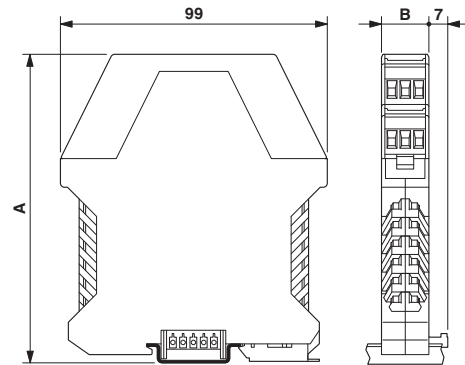

Drilling diagram

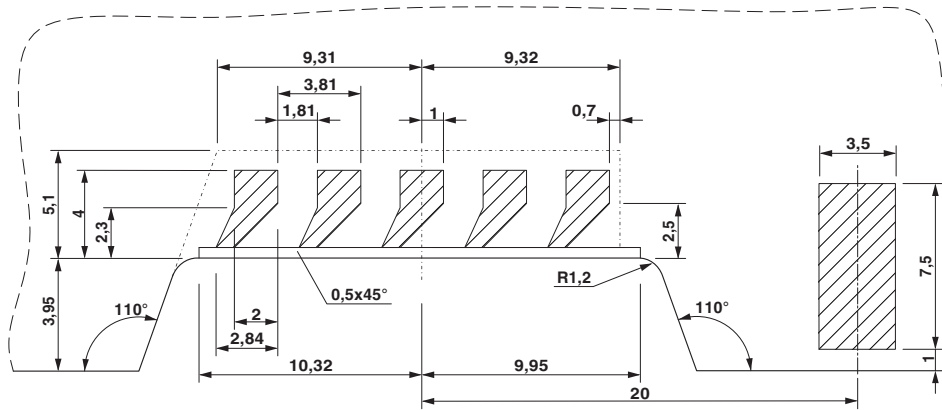

Detailed dimensional drawing of the DIN rail connector contact pads

Electronic housing - ME 17,5 TBUS 1,5/ 5-ST-3,81 KM - 2713645

Dimensional drawing

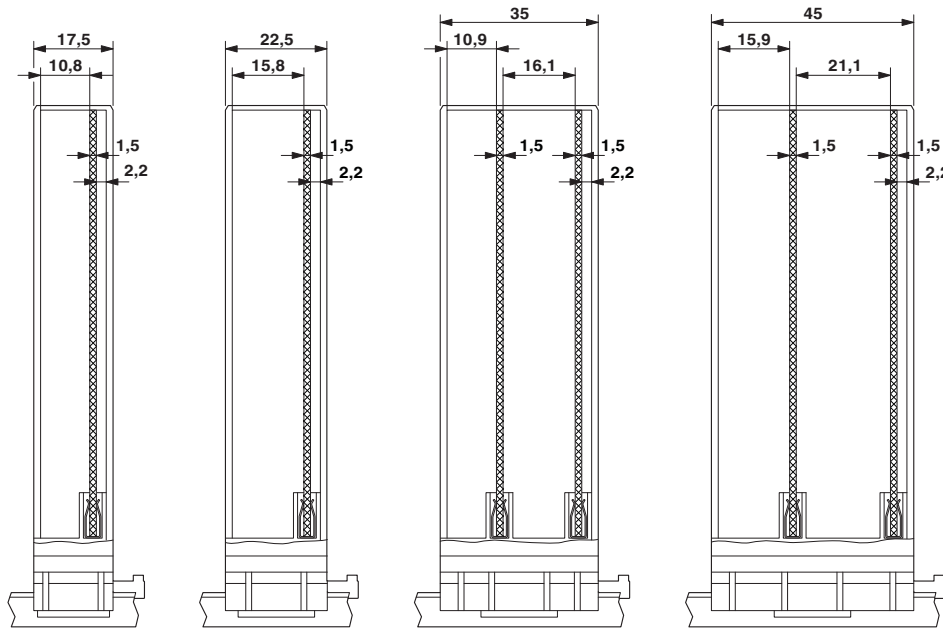

Approvals

Approvals

Approvals

UL Recognized / cUL Recognized / EAC / UL Recognized / cULus Recognized

Ex Approvals

Approval details

UL Recognized  <http://database.ul.com/cgi-bin/XYVV/template/LISEXT/1FRAME/index.htm> FILE E 240868

Electronic housing - ME 17,5 TBUS 1,5/ 5-ST-3,81 KM - 2713645

Approvals

cUL Recognized  http://database.ul.com/cgi-bin/XYV/template/LISEXT/1FRAME/index.htm FILE E 60425		
	B	D
Nominal current IN	8 A	8 A
Nominal voltage UN	150 V	150 V

EAC EAC-Zulassung

UL Recognized  http://database.ul.com/cgi-bin/XYV/template/LISEXT/1FRAME/index.htm FILE E 60425		
	B	D
Nominal current IN	8 A	8 A
Nominal voltage UN	150 V	150 V

cULus Recognized  http://database.ul.com/cgi-bin/XYV/template/LISEXT/1FRAME/index.htm		
--	--	--