

THIS DRAWING IS UNPUBLISHED. RELEASED FOR PUBLICATION ALL RIGHTS RESERVED.

LOC	DIST	REVISIONS					
DW		P	LTR	DESCRIPTION	DATE	DWN	APVD
		B2		REVISED (ECR-11-017441)	22AUG2011	S.Y	H.K

2023519-1: AS SHOWN

NOTE:

- ① MATERIAL:
 - ① HOUSING: HIGH TEMP. THERMOPLASTIC(LCP), WITH G/F, UL 94V-0, COLOR: BLACK.
 - ② CONTACT: COPPER ALLOY
 - ③ CAP: HIGH TEMP. THERMOPLASTIC, UL 94V-0, COLOR: BLACK.
- ② FINISH:
 - CONTACT: AU 0.762um [30u"] MIN. ON THE CONTACT AREA.
 - MATT TIN 2.54um [100u"] MIN. ON THE SOLDER TAIL AREA.
 - NI 1.27 um [50u"] MIN. UNDER PLATED OVERALL.
- 3. REFLOW SOLDER CAPABLE TO 260°C PER TE TEST SPEC. 109-201, CONDITION B.
- ④ NO ACCUMULATIVE TOLERANCES.

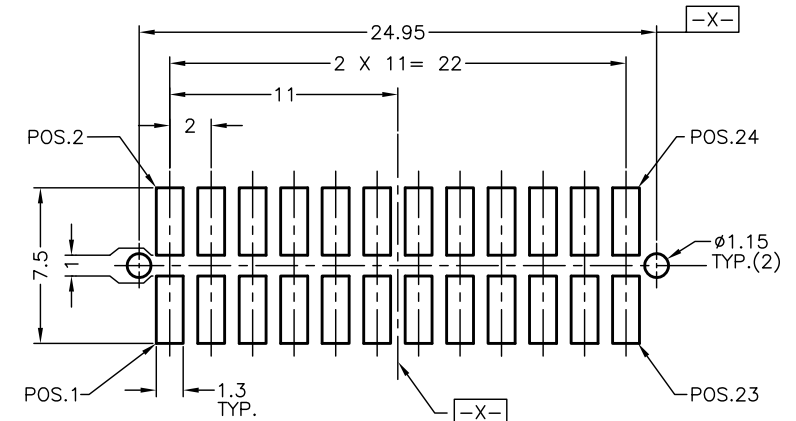
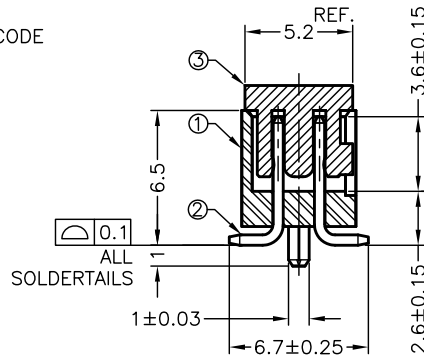
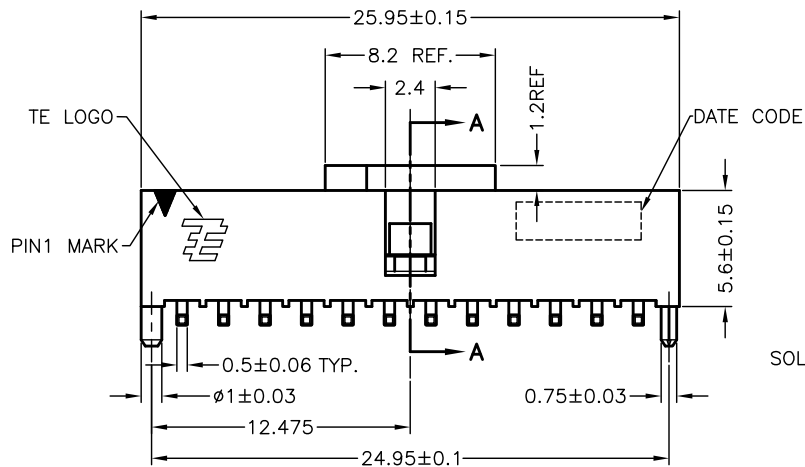
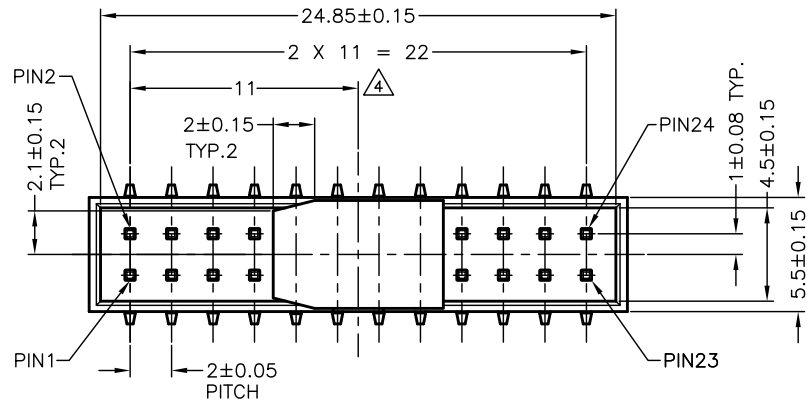

RECOMMENDED PCB LAYOUT
TOLERANCE: ±0.05

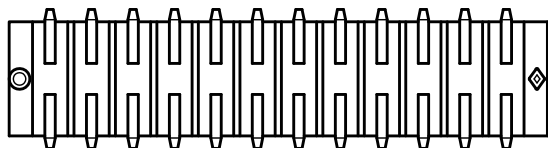

THIS DRAWING IS A CONTROLLED DOCUMENT.		DWN S. YANG 22JUN2009	STE TE Connectivity	
		CHK M. CHAO 22JUN2009		
DIMENSIONS: mm		APVD H. KODAMA 22JUN2009	NAME AMPMODU 2.00MM PITCH DUAL ROW PLUG SMT-TYPE CONN.	
TOLERANCES UNLESS OTHERWISE SPECIFIED: 3. PLC ± 1. PLC ±0.25 2. PLC ± 5. PLC ±3' 4. PLC ± ANGLES ±		PRODUCT SPEC 108-99023	DRAWING NO A3 00779	
MATERIAL ①		APPLICATION SPEC	RESTRICTED TO	
FINISH ②		WEIGHT 1.13 g	SCALE 4:1	
		CUSTOMER DRAWING	SHEET 1 OF 2	
			REV B2	

THIS DRAWING IS UNPUBLISHED.

RELEASED FOR PUBLICATION

ALL RIGHTS RESERVED.

© COPYRIGHT -- By --

LOC DW

DIST

REVISIONS

P	LTR	DESCRIPTION	DATE	DWN	APVD
-	-	SEE SHEET 1			

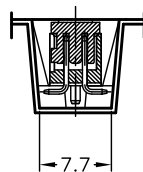
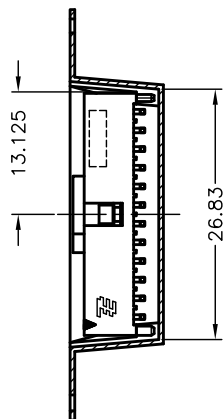
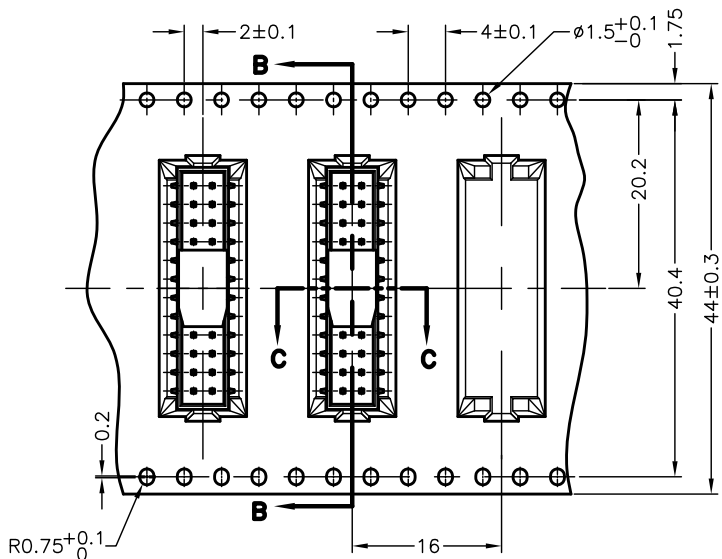

B-B

C-C

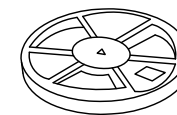

4 REELS/ BOX



AIR CAP
4 PCS

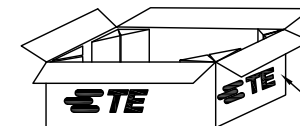

SHIPPING
BOX

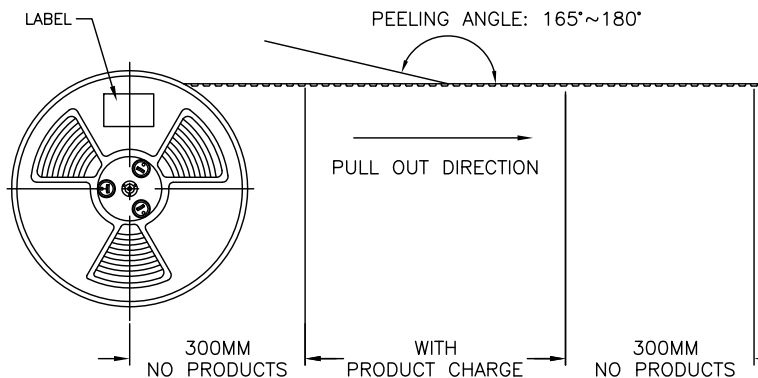
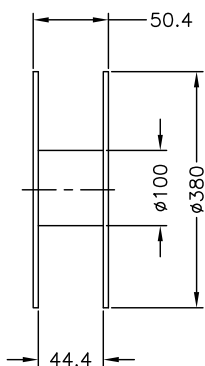
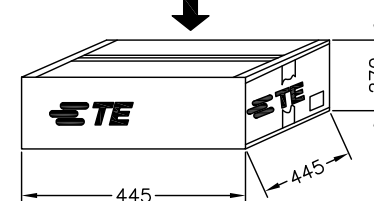
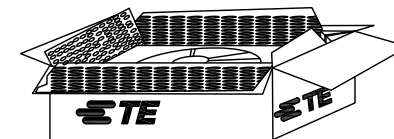

6.69	2.26	2000	500	4
KG/GROSS WEIGHT	KG/NET WEIGHT	PCS/ BOX	PCS/ REEL	REEL/ SHIPPING BOX

THIS DRAWING IS A CONTROLLED DOCUMENT.

DIMENSIONS: mm

TOLERANCES UNLESS OTHERWISE SPECIFIED:

6. PLC	±	
1.7. PLC	±	±0.5
2. PLC	±	±3°
3. PLC	±	
4. PLC	±	
ANGLES	±	

MATERIAL: PS

FINISH:

STE TE Connectivity

NAME: AMPMODU 2.00MM PITCH DUAL ROW PLUG SMT-TYPE CONN.

SIZE: A3 CAGE CODE: 00779 DRAWING NO: 2023519

RESTRICTED TO:

CUSTOMER DRAWING

SCALE: FREE SHEET: 2 OF 2 REV: B2

Mouser Electronics

Authorized Distributor

Click to View Pricing, Inventory, Delivery & Lifecycle Information:

[TE Connectivity:](#)

[2023519-1](#)