

PN 1-1534126-1  
CODING **A** (GROOVES A-C) AS SHOWN  
Kodierung (Nuten A-C) wie gezeigt

**DELIVERY CONDITION:**  
**Lieferzustand:**  
SECONDARY LOCKING DEVICE IN PRE-LOCKED POSITION, LEVER IN LOCKED POSITION.  
2. Kontaktsicherung in Vorraststellung, Hebel in Verriegelungsstellung.

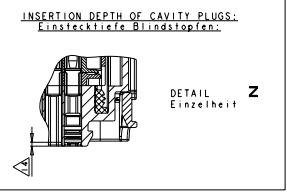
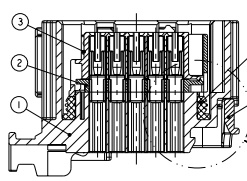
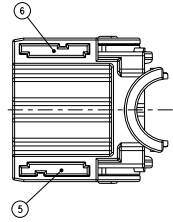
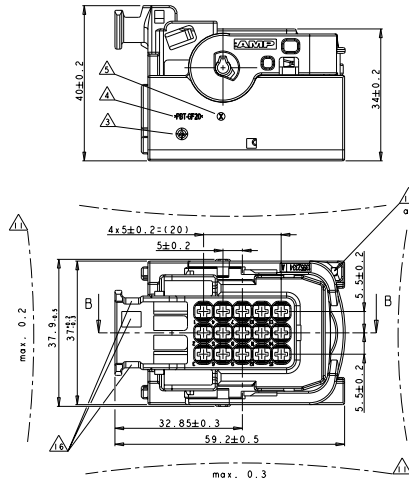
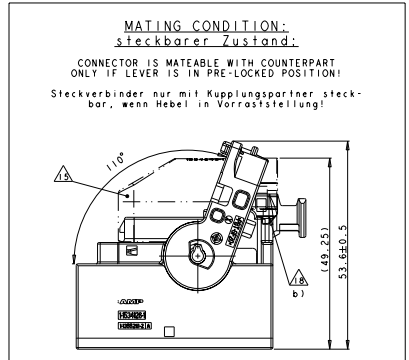

REV.	DESCRIPTION	DATE	BY	CHK
1	ISSUED FOR PRODUCTION	18-JUN-03	...	...
2	REVISIONS			
A1	SEALING HOUSING DEVICE CONNECTED	18-JUN-03	...	...
B	LOCKING (ONCE OF SECONDARY LOCKING DEVICE INCREASED)	20-NOV-09	...	...

- NOTES**  
Bemerkungen
- AMP LOGO AND TE PART NUMBER ASS-Y  
AMP Logo und TE Nummer veranlassen!
  - CAVITY NUMBERING  
Hohlraumnummerierung
  - PRODUCTION DATE OF ITEM 1  
Produktionsdatum von Pos. 1
  - MATERIAL MARKING OF ITEM 1 ACC. TO: VDA 240  
Materialebene Kennzeichnung von Pos. 1 nach VDA 240
  - MOULD CAVITY MARKING  
Werkzeughohlraum Kennzeichnung
  - LAYER PACKAGING IN CORRUGATED SHIPPING BOX  
Lagerverpackung im Versandkarton
  - FITS TO TE INTERFACE DRAWING FOR TAB CONNECTOR 114-18085-030  
Passt zu TE Anschluss-Ausführungszeichnung 114-18085-030
  - CAVITIES MATED WITH AMP MCP 2.8 CONTACTS (SBS) SEE PRODUCT GROUP DRAWING TC: 1353036  
MAX. WIRESIZE: 2.5mm² FLR  
Hohlraumnummerierung passt nur AMP MCP 2.8 Kontakte (SBS) siehe Produkt-Gruppenzeichnung TC: 1353036  
Max. Drahtgrößenbereich: 2.5mm² FLR
  - SLIDING DISTANCE OF SECONDARY LOCKING DEV.  
Verschiebung der zweiten Kontaktsicherung
  - DESIGNED FOR CORRUGATED TUBE MW3  
Ausgelegt für Wellrohr MW3
  - BARPAGE TO ... PERMITTED  
Verzög. Zulassung bis ...
  - TE PART NUMBER OF ITEM 1  
Teilenummer von Pos. 1
  - REVISION STATUS OF ITEM 1  
Revisionsstand von Pos. 1
  - INSERTION DEPTH OF CAVITY PLUG: 110°  
CAVITY PLUG IS SHOWN SYMBOLICALLY ONLY AND NOT A PART OF ASS-Y 1534126-1  
Einstecktiefe der Blindstopfen: 110°  
Blindstopfen ist nur symbolisch dargestellt und kein Bestandteil der Veranlassung 1534126-1 TC: 1353036
  - FITTING COVER SEE DRAWING COVER IS NOT A PART OF ASS-Y 1534126-1  
Passende Abdeckhaube s. Zeichnung (siehe Tabelle mit Teil-Bezeichnung) der Veranlassung 1534126-1 TC: 1353036
  - SUITABLE CABLE TIE: MAX. WIDTH 4.0mm  
Passender Kabelbinder: max. Breite 4.0mm
  - MALFUNCTION CAUSED BY LACQUER IS NOT COVERED BY TE WARRENTS  
Funktionsbeeinträchtigung durch Lackieren liegt nicht im Einfluss und Gewährleistungsumfang von TE
  - FEATURES FOR OPTIONAL SEALING WITH TE  
a) DIAMETER RESP. WIDTH 1.5mm  
b) SEALING HOUSING/LEVER 2 CONNECTION  
c) SEALING HOUSING/CAF (BOTH SIDES)  
Elemente für optionale Plombierung mit Dichtung:  
a) Plombierung Gehäuse/Hebel 2 Steckverbinder  
b) Plombierung Gehäuse/Hebel 1 Steckverbinder

**FURTHER REALIZED CODINGS**  
weitere existierende Kodierungen

**SCALE 1:1**  
M

**FURTHER POSSIBLE CODING**  
weitere Kodierungsmöglichkeit

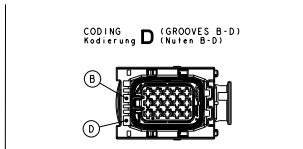
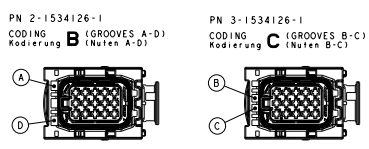

REV.	DESCRIPTION	DATE	BY	CHK
1	ISSUED FOR PRODUCTION	18-JUN-03	...	...
2	REVISIONS			
A1	SEALING HOUSING DEVICE CONNECTED	18-JUN-03	...	...
B	LOCKING (ONCE OF SECONDARY LOCKING DEVICE INCREASED)	20-NOV-09	...	...

REV.	DESCRIPTION	DATE	BY	CHK
1	ISSUED FOR PRODUCTION	18-JUN-03	...	...
2	REVISIONS			
A1	SEALING HOUSING DEVICE CONNECTED	18-JUN-03	...	...
B	LOCKING (ONCE OF SECONDARY LOCKING DEVICE INCREASED)	20-NOV-09	...	...

REV.	DESCRIPTION	DATE	BY	CHK
1	ISSUED FOR PRODUCTION	18-JUN-03	...	...
2	REVISIONS			
A1	SEALING HOUSING DEVICE CONNECTED	18-JUN-03	...	...
B	LOCKING (ONCE OF SECONDARY LOCKING DEVICE INCREASED)	20-NOV-09	...	...

REV.	DESCRIPTION	DATE	BY	CHK
1	ISSUED FOR PRODUCTION	18-JUN-03	...	...
2	REVISIONS			
A1	SEALING HOUSING DEVICE CONNECTED	18-JUN-03	...	...
B	LOCKING (ONCE OF SECONDARY LOCKING DEVICE INCREASED)	20-NOV-09	...	...

REV.	DESCRIPTION	DATE	BY	CHK
1	ISSUED FOR PRODUCTION	18-JUN-03	...	...
2	REVISIONS			
A1	SEALING HOUSING DEVICE CONNECTED	18-JUN-03	...	...
B	LOCKING (ONCE OF SECONDARY LOCKING DEVICE INCREASED)	20-NOV-09	...	...

REV.	DESCRIPTION	DATE	BY	CHK
1	ISSUED FOR PRODUCTION	18-JUN-03	...	...
2	REVISIONS			
A1	SEALING HOUSING DEVICE CONNECTED	18-JUN-03	...	...
B	LOCKING (ONCE OF SECONDARY LOCKING DEVICE INCREASED)	20-NOV-09	...	...

REV.	DESCRIPTION	DATE	BY	CHK
1	ISSUED FOR PRODUCTION	18-JUN-03	...	...
2	REVISIONS			
A1	SEALING HOUSING DEVICE CONNECTED	18-JUN-03	...	...
B	LOCKING (ONCE OF SECONDARY LOCKING DEVICE INCREASED)	20-NOV-09	...	...

REV.	DESCRIPTION	DATE	BY	CHK
1	ISSUED FOR PRODUCTION	18-JUN-03	...	...
2	REVISIONS			
A1	SEALING HOUSING DEVICE CONNECTED	18-JUN-03	...	...
B	LOCKING (ONCE OF SECONDARY LOCKING DEVICE INCREASED)	20-NOV-09	...	...

REV.	DESCRIPTION	DATE	BY	CHK
1	ISSUED FOR PRODUCTION	18-JUN-03	...	...
2	REVISIONS			
A1	SEALING HOUSING DEVICE CONNECTED	18-JUN-03	...	...
B	LOCKING (ONCE OF SECONDARY LOCKING DEVICE INCREASED)	20-NOV-09	...	...

REV.	DESCRIPTION	DATE	BY	CHK
1	ISSUED FOR PRODUCTION	18-JUN-03	...	...
2	REVISIONS			
A1	SEALING HOUSING DEVICE CONNECTED	18-JUN-03	...	...
B	LOCKING (ONCE OF SECONDARY LOCKING DEVICE INCREASED)	20-NOV-09	...	...

REV.	DESCRIPTION	DATE	BY	CHK
1	ISSUED FOR PRODUCTION	18-JUN-03	...	...
2	REVISIONS			
A1	SEALING HOUSING DEVICE CONNECTED	18-JUN-03	...	...
B	LOCKING (ONCE OF SECONDARY LOCKING DEVICE INCREASED)	20-NOV-09	...	...

REV.	DESCRIPTION	DATE	BY	CHK
1	ISSUED FOR PRODUCTION	18-JUN-03	...	...
2	REVISIONS			
A1	SEALING HOUSING DEVICE CONNECTED	18-JUN-03	...	...
B	LOCKING (ONCE OF SECONDARY LOCKING DEVICE INCREASED)	20-NOV-09	...	...

REV.	DESCRIPTION	DATE	BY	CHK
1	ISSUED FOR PRODUCTION	18-JUN-03	...	...
2	REVISIONS			
A1	SEALING HOUSING DEVICE CONNECTED	18-JUN-03	...	...
B	LOCKING (ONCE OF SECONDARY LOCKING DEVICE INCREASED)	20-NOV-09	...	...

REV.	DESCRIPTION	DATE	BY	CHK
1	ISSUED FOR PRODUCTION	18-JUN-03	...	...
2	REVISIONS			
A1	SEALING HOUSING DEVICE CONNECTED	18-JUN-03	...	...
B	LOCKING (ONCE OF SECONDARY LOCKING DEVICE INCREASED)	20-NOV-09	...	...

REV.	DESCRIPTION	DATE	BY	CHK
1	ISSUED FOR PRODUCTION	18-JUN-03	...	...
2	REVISIONS			
A1	SEALING HOUSING DEVICE CONNECTED	18-JUN-03	...	...
B	LOCKING (ONCE OF SECONDARY LOCKING DEVICE INCREASED)	20-NOV-09	...	...

REV.	DESCRIPTION	DATE	BY	CHK
1	ISSUED FOR PRODUCTION	18-JUN-03	...	...
2	REVISIONS			
A1	SEALING HOUSING DEVICE CONNECTED	18-JUN-03	...	...
B	LOCKING (ONCE OF SECONDARY LOCKING DEVICE INCREASED)	20-NOV-09	...	...

REV.	DESCRIPTION	DATE	BY	CHK
1	ISSUED FOR PRODUCTION	18-JUN-03	...	...
2	REVISIONS			
A1	SEALING HOUSING DEVICE CONNECTED	18-JUN-03	...	...
B	LOCKING (ONCE OF SECONDARY LOCKING DEVICE INCREASED)	20-NOV-09	...	...

REV.	DESCRIPTION	DATE	BY	CHK
1	ISSUED FOR PRODUCTION	18-JUN-03	...	...
2	REVISIONS			
A1	SEALING HOUSING DEVICE CONNECTED	18-JUN-03	...	...
B	LOCKING (ONCE OF SECONDARY LOCKING DEVICE INCREASED)	20-NOV-09	...	...

REV.	DESCRIPTION	DATE	BY	CHK
1	ISSUED FOR PRODUCTION	18-JUN-03	...	...
2	REVISIONS			
A1	SEALING HOUSING DEVICE CONNECTED	18-JUN-03	...	...
B	LOCKING (ONCE OF SECONDARY LOCKING DEVICE INCREASED)	20-NOV-09	...	...

REV.	DESCRIPTION	DATE	BY	CHK
1	ISSUED FOR PRODUCTION	18-JUN-03	...	...
2	REVISIONS			
A1	SEALING HOUSING DEVICE CONNECTED	18-JUN-03	...	...
B	LOCKING (ONCE OF SECONDARY LOCKING DEVICE INCREASED)	20-NOV-09	...	...

REV.	DESCRIPTION	DATE	BY	CHK
1	ISSUED FOR PRODUCTION	18-JUN-03	...	...
2	REVISIONS			
A1	SEALING HOUSING DEVICE CONNECTED	18-JUN-03	...	...
B	LOCKING (ONCE OF SECONDARY LOCKING DEVICE INCREASED)	20-NOV-09	...	...

REV.	DESCRIPTION	DATE	BY	CHK
1	ISSUED FOR PRODUCTION	18-JUN-03	...	...
2	REVISIONS			
A1	SEALING HOUSING DEVICE CONNECTED	18-JUN-03	...	...
B	LOCKING (ONCE OF SECONDARY LOCKING DEVICE INCREASED)	20-NOV-09	...	...

REV.	DESCRIPTION	DATE	BY	CHK
1	ISSUED FOR PRODUCTION	18-JUN-03	...	...
2	REVISIONS			
A1	SEALING HOUSING DEVICE CONNECTED	18-JUN-03	...	...
B	LOCKING (ONCE OF SECONDARY LOCKING DEVICE INCREASED)	20-NOV-09	...	...

REV.	DESCRIPTION	DATE	BY	CHK
1	ISSUED FOR PRODUCTION	18-JUN-03	...	...
2	REVISIONS			
A1	SEALING HOUSING DEVICE CONNECTED	18-JUN-03	...	...
B	LOCKING (ONCE OF SECONDARY LOCKING DEVICE INCREASED)	20-NOV-09	...	...

REV.	DESCRIPTION	DATE	BY	CHK
1	ISSUED FOR PRODUCTION	18-JUN-03	...	...
2	REVISIONS			
A1	SEALING HOUSING DEVICE CONNECTED	18-JUN-03	...	...
B	LOCKING (ONCE OF SECONDARY LOCKING DEVICE INCREASED)	20-NOV-09	...	...

REV.	DESCRIPTION	DATE	BY	CHK
1	ISSUED FOR PRODUCTION	18-JUN-03	...	...
2	REVISIONS			
A1	SEALING HOUSING DEVICE CONNECTED	18-JUN-03	...	...
B	LOCKING (ONCE OF SECONDARY LOCKING DEVICE INCREASED)	20-NOV-09	...	...

REV.	DESCRIPTION	DATE	BY	CHK
1	ISSUED FOR PRODUCTION	18-JUN-03	...	...
2	REVISIONS			
A1	SEALING HOUSING DEVICE CONNECTED	18-JUN-03	...	...
B	LOCKING (ONCE OF SECONDARY LOCKING DEVICE INCREASED)	20-NOV-09	...	...

REV.	DESCRIPTION	DATE	BY	CHK
1	ISSUED FOR PRODUCTION	18-JUN-03	...	...
2	REVISIONS			
A1	SEALING HOUSING DEVICE CONNECTED	18-JUN-03	...	...
B	LOCKING (ONCE OF SECONDARY LOCKING DEVICE INCREASED)	20-NOV-09	...	...

REV.	DESCRIPTION	DATE	BY	CHK
1	ISSUED FOR PRODUCTION	18-JUN-03	...	...
2	REVISIONS			
A1	SEALING HOUSING DEVICE CONNECTED	18-JUN-03	...	...
B	LOCKING (ONCE OF SECONDARY LOCKING DEVICE INCREASED)	20-NOV-09	...	...

REV.	DESCRIPTION	DATE	BY	CHK
1	ISSUED FOR PRODUCTION	18-JUN-03	...	...
2	REVISIONS			
A1	SEALING HOUSING DEVICE CONNECTED	18-JUN-03	...	...
B	LOCKING (ONCE OF SECONDARY LOCKING DEVICE INCREASED)	20-NOV-09	...	...

REV.	DESCRIPTION	DATE	BY	CHK
1	ISSUED FOR PRODUCTION	18-JUN-03	...	...
2	REVISIONS			
A1	SEALING HOUSING DEVICE CONNECTED	18-JUN-03	...	...
B	LOCKING (ONCE OF SECONDARY LOCKING DEVICE INCREASED)	20-NOV-09	...	...

REV.	DESCRIPTION	DATE	BY	CHK
1	ISSUED FOR PRODUCTION	18-JUN-03	...	...
2	REVISIONS			
A1	SEALING HOUSING DEVICE CONNECTED	18-JUN-03	...	...
B	LOCKING (ONCE OF SECONDARY LOCKING DEVICE INCREASED)	20-NOV-09	...	...

REV.	DESCRIPTION	DATE	BY	CHK
1	ISSUED FOR PRODUCTION	18-JUN-03	...	...
2	REVISIONS			
A1	SEALING HOUSING DEVICE CONNECTED	18-JUN-03	...	...
B	LOCKING (ONCE OF SECONDARY LOCKING DEVICE INCREASED)	20-NOV-09	...	...

REV.	DESCRIPTION	DATE	BY	CHK
1	ISSUED FOR PRODUCTION	18-JUN-03	...	...
2	REVISIONS			
A1	SEALING HOUSING DEVICE CONNECTED	18-JUN-03	...	...
B	LOCKING (ONCE OF SECONDARY LOCKING DEVICE INCREASED)	20-NOV-09	...	...

REV.	DESCRIPTION	DATE	BY	CHK
1	ISSUED FOR PRODUCTION	18-JUN-03	...	...
2	REVISIONS			
A1	SEALING HOUSING DEVICE CONNECTED	18-JUN-03	...	...
B	LOCKING (ONCE OF SECONDARY LOCKING DEVICE INCREASED)	20-NOV-09	...	...

REV.	DESCRIPTION	DATE	BY	CHK
1	ISSUED FOR PRODUCTION	18-JUN-03	...	...
2	REVISIONS			
A1	SEALING HOUSING DEVICE CONNECTED	18-JUN-03	...	...
B	LOCKING (ONCE OF SECONDARY LOCKING DEVICE INCREASED)	20-NOV-09	...	...

REV.	DESCRIPTION	DATE	BY	CHK
1	ISSUED FOR PRODUCTION	18-JUN-03	...	...
2	REVISIONS			
A1	SEALING HOUSING DEVICE CONNECTED	18-JUN-03	...	...
B	LOCKING (ONCE OF SECONDARY LOCKING DEVICE INCREASED)	20-NOV-09	...	...

REV.	DESCRIPTION
------	-------------