

THIS DRAWING IS UNPUBLISHED.

RELEASED FOR PUBLICATION

---

© COPYRIGHT - By -

ALL RIGHTS RESERVED.

LOC	DIST	REVISIONS			
P	LTR	DESCRIPTION	DATE	DWN	APVD
H	—	A	INITIAL RELEASE	16JAN2014	GSK BvH

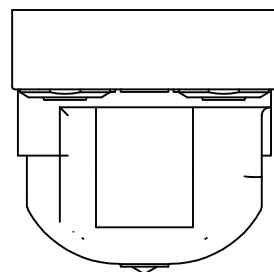
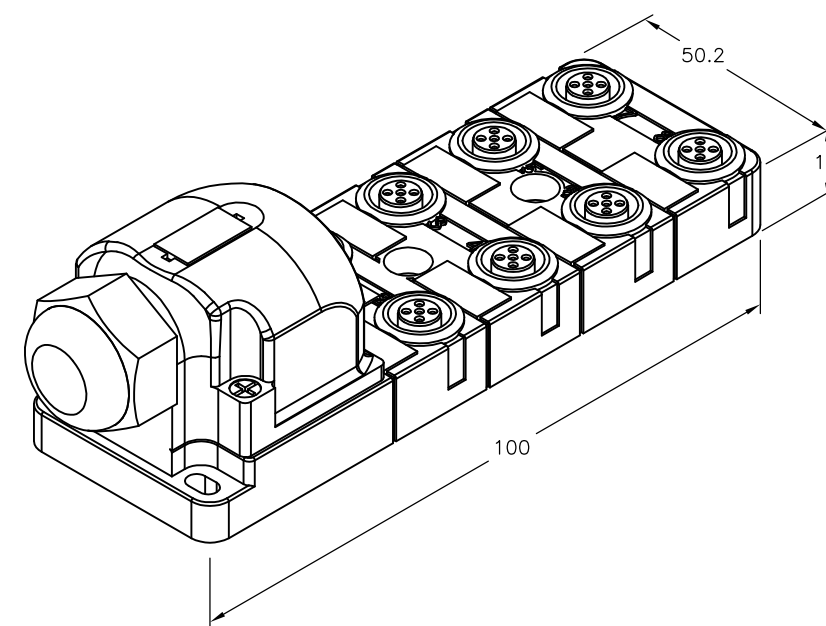
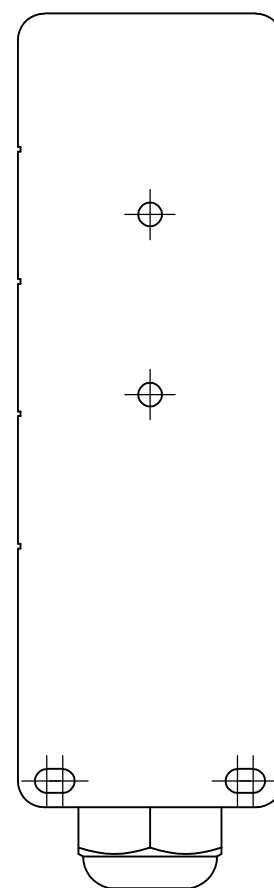
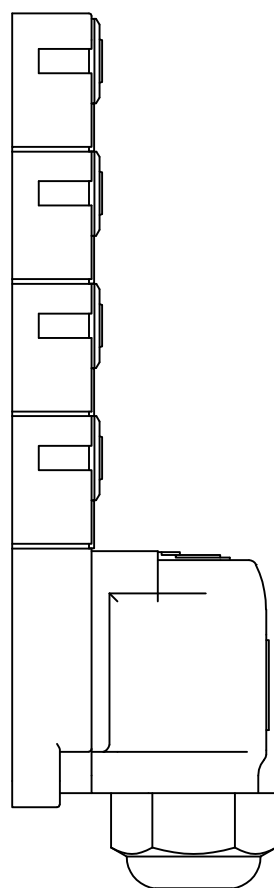
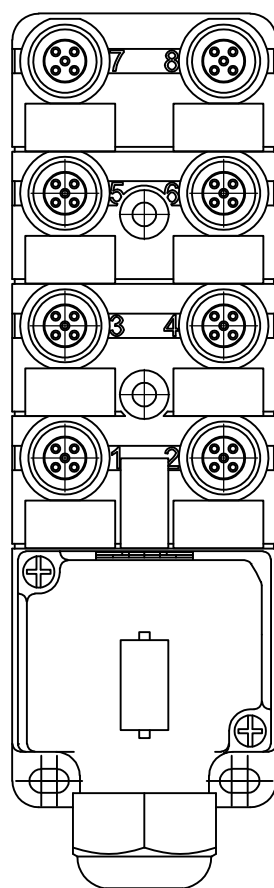
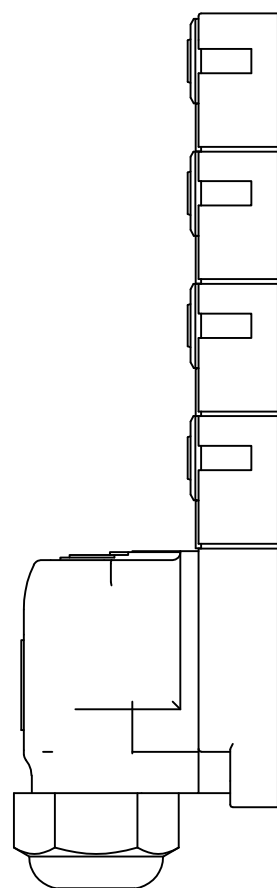
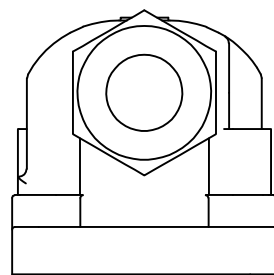

Without Homerun Cable	2273152-1
DESCRIPTION	TE PN

THIS DRAWING IS A CONTROLLED DOCUMENT.		DWN 16JAN2014 SATHISH KUMAR .G	 TE Connectivity														
DIMENSIONS: mm		CHK 16JAN2014 B.VELDHOVEN															
TOLERANCES UNLESS OTHERWISE SPECIFIED:		APVD 16JAN2014 A.VAN ZANDVOORT	NAME DISTR BOX M12 5POS 4WAY PNP														
<table border="1"> <tr><td>0 PLC</td><td>± -</td></tr> <tr><td>1 PLC</td><td>± -</td></tr> <tr><td>2 PLC</td><td>± -</td></tr> <tr><td>3 PLC</td><td>± -</td></tr> <tr><td>4 PLC</td><td>± -</td></tr> <tr><td>ANGLES</td><td>± -</td></tr> </table>		0 PLC	± -	1 PLC	± -	2 PLC	± -	3 PLC	± -	4 PLC	± -	ANGLES	± -	PRODUCT SPEC —	—		
0 PLC	± -																
1 PLC	± -																
2 PLC	± -																
3 PLC	± -																
4 PLC	± -																
ANGLES	± -																
MATERIAL —		FINISH —	APPLICATION SPEC —	SIZE A3	CAGE CODE 00779												
CUSTOMER DRAWING			DRAWING NO C-2273152	RESTRICTED TO —	SCALE NTS												
			WEIGHT —	SHEET 1 OF 2	REV A												

THIS DRAWING IS UNPUBLISHED. RELEASED FOR PUBLICATION  
 © COPYRIGHT - By - ALL RIGHTS RESERVED.

LOC	DIST	REVISIONS			
P	LTR	DESCRIPTION	DATE	DWN	APVD
H	-	SEE SHEET 1	-	-	-

### Contact layout

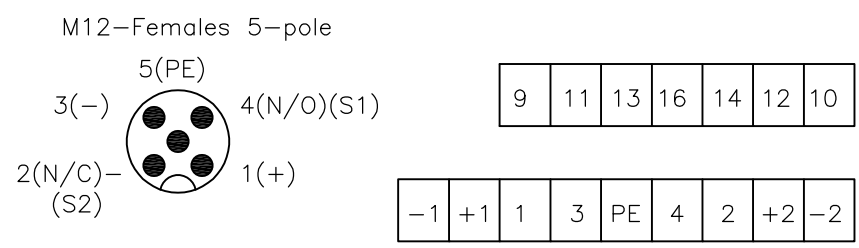

### Circuit diagram

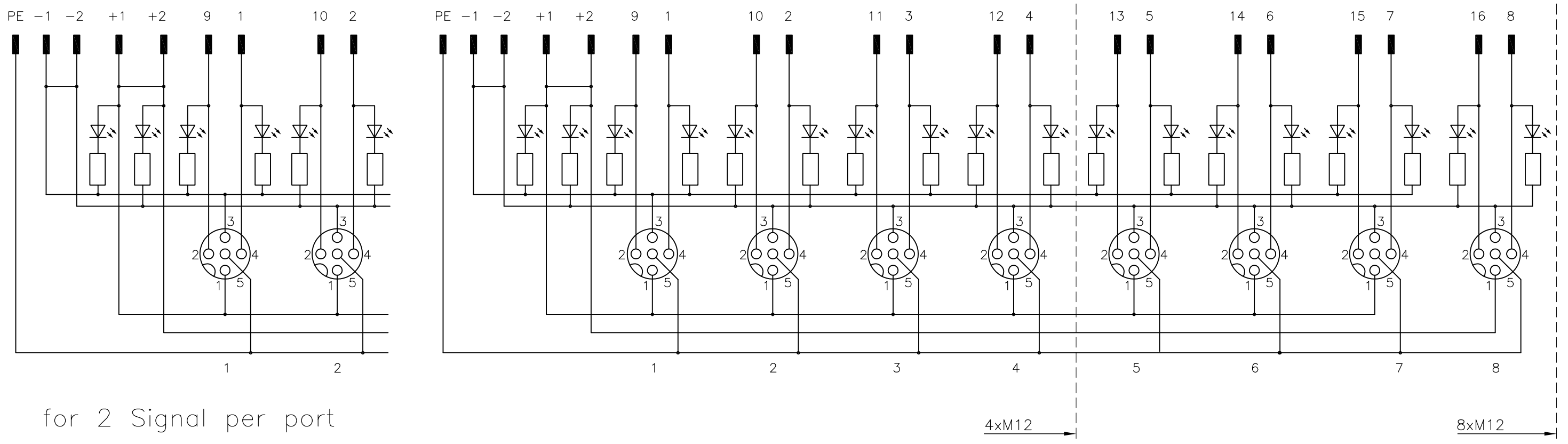

THIS DRAWING IS A CONTROLLED DOCUMENT.		DWN	16JAN2014		 TE Connectivity
		CHK	16JAN2014		
		APVD	16JAN2014		
		PRODUCT SPEC			
DIMENSIONS: mm		TOLERANCES UNLESS OTHERWISE SPECIFIED:		NAME	
		0 PLC ± - 1 PLC ± - 2 PLC ± - 3 PLC ± - 4 PLC ± - ANGLES ± -		B.VELDHOVEN A.VAN ZANDVOORT	
MATERIAL		FINISH		PRODUCT SPEC	
				APPLICATION SPEC	
				WEIGHT	
				SIZE	
				CAGE CODE	
				DRAWING NO	
				RESTRICTED TO	
				A3 00779	
				C=2273152	
				SCALE	
				SHEET	
				2 OF 2	
				REV	
				A	
				CUSTOMER DRAWING	

# Mouser Electronics

Authorized Distributor

Click to View Pricing, Inventory, Delivery & Lifecycle Information:

[TE Connectivity:](#)

[2273152-1](#)