



Is Now Part of



ON Semiconductor®

To learn more about ON Semiconductor, please visit our website at
www.onsemi.com

ON Semiconductor and the ON Semiconductor logo are trademarks of Semiconductor Components Industries, LLC dba ON Semiconductor or its subsidiaries in the United States and/or other countries. ON Semiconductor owns the rights to a number of patents, trademarks, copyrights, trade secrets, and other intellectual property. A listing of ON Semiconductor's product/patent coverage may be accessed at www.onsemi.com/site/pdf/Patent-Marking.pdf. ON Semiconductor reserves the right to make changes without further notice to any products herein. ON Semiconductor makes no warranty, representation or guarantee regarding the suitability of its products for any particular purpose, nor does ON Semiconductor assume any liability arising out of the application or use of any product or circuit, and specifically disclaims any and all liability, including without limitation special, consequential or incidental damages. Buyer is responsible for its products and applications using ON Semiconductor products, including compliance with all laws, regulations and safety requirements or standards, regardless of any support or applications information provided by ON Semiconductor. "Typical" parameters which may be provided in ON Semiconductor data sheets and/or specifications can and do vary in different applications and actual performance may vary over time. All operating parameters, including "Typicals" must be validated for each customer application by customer's technical experts. ON Semiconductor does not convey any license under its patent rights nor the rights of others. ON Semiconductor products are not designed, intended, or authorized for use as a critical component in life support systems or any FDA Class 3 medical devices or medical devices with a same or similar classification in a foreign jurisdiction or any devices intended for implantation in the human body. Should Buyer purchase or use ON Semiconductor products for any such unintended or unauthorized application, Buyer shall indemnify and hold ON Semiconductor and its officers, employees, subsidiaries, affiliates, and distributors harmless against all claims, costs, damages, and expenses, and reasonable attorney fees arising out of, directly or indirectly, any claim of personal injury or death associated with such unintended or unauthorized use, even if such claim alleges that ON Semiconductor was negligent regarding the design or manufacture of the part. ON Semiconductor is an Equal Opportunity/Affirmative Action Employer. This literature is subject to all applicable copyright laws and is not for resale in any manner.

FAN3226 / FAN3227 / FAN3228 / FAN3229

Dual 2-A High-Speed, Low-Side Gate Drivers

Features

- Industry-Standard Pinouts
- 4.5-V to 18-V Operating Range
- 3-A Peak Sink/Source at $V_{DD} = 12\text{ V}$
- 2.4 A-Sink / 1.6-A Source at $V_{OUT} = 6\text{ V}$
- Choice of TTL or CMOS Input Thresholds
- Four Versions of Dual Independent Drivers:
 - Dual Inverting + Enable (FAN3226)
 - Dual Non-Inverting + Enable (FAN3227)
 - Dual Inputs in Two Pin-Out Configurations:
 - Compatible with FAN3225x (FAN3228)
 - Compatible with TPS2814D (FAN3229)
- Internal Resistors Turn Driver Off If No Inputs
- MillerDrive™ Technology
- 12-ns / 9-ns Typical Rise/Fall Times (1-nF Load)
- Under 20-ns Typical Propagation Delay Matched within 1 ns to the Other Channel
- Double Current Capability by Paralleling Channels
- 8-Lead 3x3 mm MLP or 8-Lead SOIC Package
- Rated from -40°C to $+125^{\circ}\text{C}$ Ambient
- Automotive Qualified to AEC-Q100 (F085 Version)

Applications

- Switch-Mode Power Supplies
- High-Efficiency MOSFET Switching
- Synchronous Rectifier Circuits
- DC-to-DC Converters
- Motor Control
- Servers
- Automotive-Qualified Systems (F085 version)

Description

The FAN3226-29 family of dual 2 A gate drivers is designed to drive N-channel enhancement-mode MOSFETs in low-side switching applications by providing high peak current pulses during the short switching intervals. The driver is available with either TTL or CMOS input thresholds. Internal circuitry provides an under-voltage lockout function by holding the output low until the supply voltage is within the operating range. In addition, the drivers feature matched internal propagation delays between A and B channels for applications requiring dual gate drives with critical timing, such as synchronous rectifiers. This enables connecting two drivers in parallel to effectively double the current capability driving a single MOSFET.

The FAN322X drivers incorporate MillerDrive™ architecture for the final output stage. This bipolar-MOSFET combination provides high current during the Miller plateau stage of the MOSFET turn-on / turn-off process to minimize switching loss, while providing rail-to-rail voltage swing and reverse current capability.

The FAN3226 offers two inverting drivers and the FAN3227 offers two non-inverting drivers. Each device has dual independent enable pins that default to ON if not connected. In the FAN3228 and FAN3229, each channel has dual inputs of opposite polarity, which allows configuration as non-inverting or inverting with an optional enable function using the second input. If one or both inputs are left unconnected, internal resistors bias the inputs such that the output is pulled low to hold the power MOSFET off.

Related Resources

- [AN-6069: Application Review and Comparative Evaluation of Low-Side Gate Drivers](#)

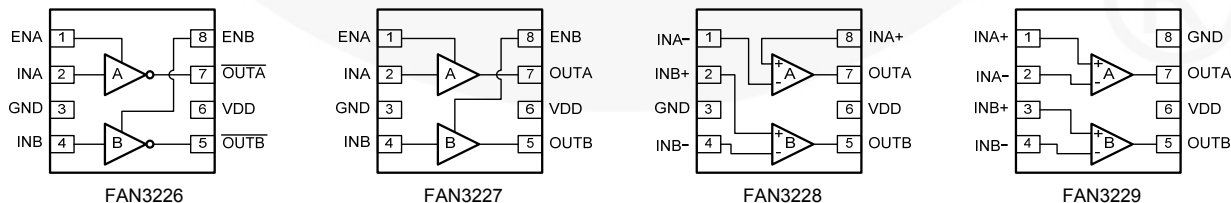

Figure 1. Pin Configurations

Ordering Information

Part Number	Logic	Input Threshold	Package	Packing Method	Quantity per Reel
FAN3226CMPX	Dual Inverting Channels + Dual Enable	CMOS	3x3 mm MLP-8	Tape & Reel	3,000
FAN3226CMX			SOIC-8	Tape & Reel	2,500
FAN3226CMX_F085 ⁽¹⁾			SOIC-8	Tape & Reel	2,500
FAN3226TMPX		TTL	3x3 mm MLP-8	Tape & Reel	3,000
FAN3226TMX			SOIC-8	Tape & Reel	2,500
FAN3226TMX_F085 ⁽¹⁾			SOIC-8	Tape & Reel	2,500
FAN3227CMPX	Dual Non-Inverting Channels + Dual Enable	CMOS	3x3 mm MLP-8	Tape & Reel	3,000
FAN3227CMX			SOIC-8	Tape & Reel	2,500
FAN3227CMX_F085 ⁽¹⁾			SOIC-8	Tape & Reel	2,500
FAN3227TMPX		TTL	3x3 mm MLP-8	Tape & Reel	3,000
FAN3227TMX			SOIC-8	Tape & Reel	2,500
FAN3227TMX_F085 ⁽¹⁾			SOIC-8	Tape & Reel	2,500
FAN3228CMX_F085 ⁽¹⁾	Dual Channels of Two-Input / One-Output Drivers, Pin Configuration 1	CMOS	SOIC-8	Tape & Reel	2,500
FAN3228TMX_F085 ⁽¹⁾		TTL	SOIC-8	Tape & Reel	2,500
FAN3229CMPX	Dual Channels of Two-Input / One-Output Drivers, Pin Configuration 2	CMOS	3x3 mm MLP-8	Tape & Reel	3,000
FAN3229CMX			SOIC-8	Tape & Reel	2,500
FAN3229CMX_F085 ⁽¹⁾			SOIC-8	Tape & Reel	2,500
FAN3229TMPX		TTL	3x3 mm MLP-8	Tape & Reel	3,000
FAN3229TMX			SOIC-8	Tape & Reel	2,500
FAN3229TMX_F085 ⁽¹⁾			SOIC-8	Tape & Reel	2,500

 All standard Fairchild Semiconductor products are RoHS compliant and many are also "Green" or going green. Green means the products are RoHS compliant AND they have limits on additional substances of Chlorine, Bromine and Antimony. For additional information on Fairchild's "green" Eco Status, please visit: http://www.fairchildsemi.com/company/green/rohs_green.html.

Note:

1. Qualified to AEC-Q100

Package Outlines



Figure 2. 3x3 mm MLP-8 (Top View)



Figure 3. SOIC-8 (Top View)

Thermal Characteristics⁽²⁾

Package	Θ_{JL} ⁽³⁾	Θ_{JT} ⁽⁴⁾	Θ_{JA} ⁽⁵⁾	Ψ_{JB} ⁽⁶⁾	Ψ_{JT} ⁽⁷⁾	Unit
8-Lead 3x3 mm Molded Leadless Package (MLP)	1.6	68	43	3.5	0.8	°C/W
8-Pin Small Outline Integrated Circuit (SOIC)	40	31	89	43	3.0	°C/W

Notes:

2. Estimates derived from thermal simulation; actual values depend on the application.
3. Θ_{JL} (Θ_{JL}): Thermal resistance between the semiconductor junction and the bottom surface of all the leads (including any thermal pad) that are typically soldered to a PCB.
4. Θ_{JT} (Θ_{JT}): Thermal resistance between the semiconductor junction and the top surface of the package, assuming it is held at a uniform temperature by a top-side heatsink.
5. Θ_{JA} (Θ_{JA}): Thermal resistance between junction and ambient, dependent on the PCB design, heat sinking, and airflow. The value given is for natural convection with no heatsink using a 2S2P board, as specified in JEDEC standards JESD51-2, JESD51-5, and JESD51-7, as appropriate.
6. Ψ_{JB} (Ψ_{JB}): Thermal characterization parameter providing correlation between semiconductor junction temperature and an application circuit board reference point for the thermal environment defined in Note 5. For the MLP-8 package, the board reference is defined as the PCB copper connected to the thermal pad and protruding from either end of the package. For the SOIC-8 package, the board reference is defined as the PCB copper adjacent to pin 6.
7. Ψ_{JT} (Ψ_{JT}): Thermal characterization parameter providing correlation between the semiconductor junction temperature and the center of the top of the package for the thermal environment defined in Note 5.



Figure 4. Pin Configurations (Repeated)

Pin Definitions

Name	Pin Description
ENA	Enable Input for Channel A. Pull pin LOW to inhibit driver A. ENA has TTL thresholds for both TTL and CMOS IN _x threshold.
ENB	Enable Input for Channel B. Pull pin LOW to inhibit driver B. ENB has TTL thresholds for both TTL and CMOS IN _x threshold.
GND	Ground. Common ground reference for input and output circuits.
INA	Input to Channel A.
INA+	Non-Inverting Input to Channel A. Connect to V _{DD} to enable output.
INA-	Inverting Input to Channel A. Connect to GND to enable output.
INB	Input to Channel B.
INB+	Non-Inverting Input to Channel B. Connect to V _{DD} to enable output.
INB-	Inverting Input to Channel B. Connect to GND to enable output.
OUTA	Gate Drive Output A: Held LOW unless required input(s) are present and V _{DD} is above UVLO threshold.
OUTB	Gate Drive Output B: Held LOW unless required input(s) are present and V _{DD} is above UVLO threshold.
$\overline{\text{OUTA}}$	Gate Drive Output A (inverted from the input): Held LOW unless required input is present and V _{DD} is above UVLO threshold.
$\overline{\text{OUTB}}$	Gate Drive Output B (inverted from the input): Held LOW unless required input is present and V _{DD} is above UVLO threshold.
P1	Thermal Pad (MLP only). Exposed metal on the bottom of the package; may be left floating or connected to GND; NOT suitable for carrying current.
VDD	Supply Voltage. Provides power to the IC.

Output Logic

FAN3226 (x=A or B)		
EN _x	IN _x	$\overline{\text{OUT}}_x$
0	0	0
0	1 ⁽⁸⁾	0
1 ⁽⁸⁾	0	1
1 ⁽⁸⁾	1 ⁽⁸⁾	0

FAN3227 (x=A or B)		
EN _x	IN _x	OUT _x
0	0 ⁽⁸⁾	0
0	1	0
1 ⁽⁸⁾	0 ⁽⁸⁾	0
1 ⁽⁸⁾	1	1

FAN3228 and FAN3229 (x=A or B)		
IN _{x+}	IN _{x-}	OUT _x
0 ⁽⁸⁾	0	0
0 ⁽⁸⁾	1 ⁽⁸⁾	0
1	0	1
1	1 ⁽⁸⁾	0

Note:

8. Default input signal if no external connection is made.

Block Diagrams



Figure 5. FAN3226 Block Diagram



Figure 6. FAN3227 Block Diagram

Block Diagrams



Figure 7. FAN3228 Block Diagram

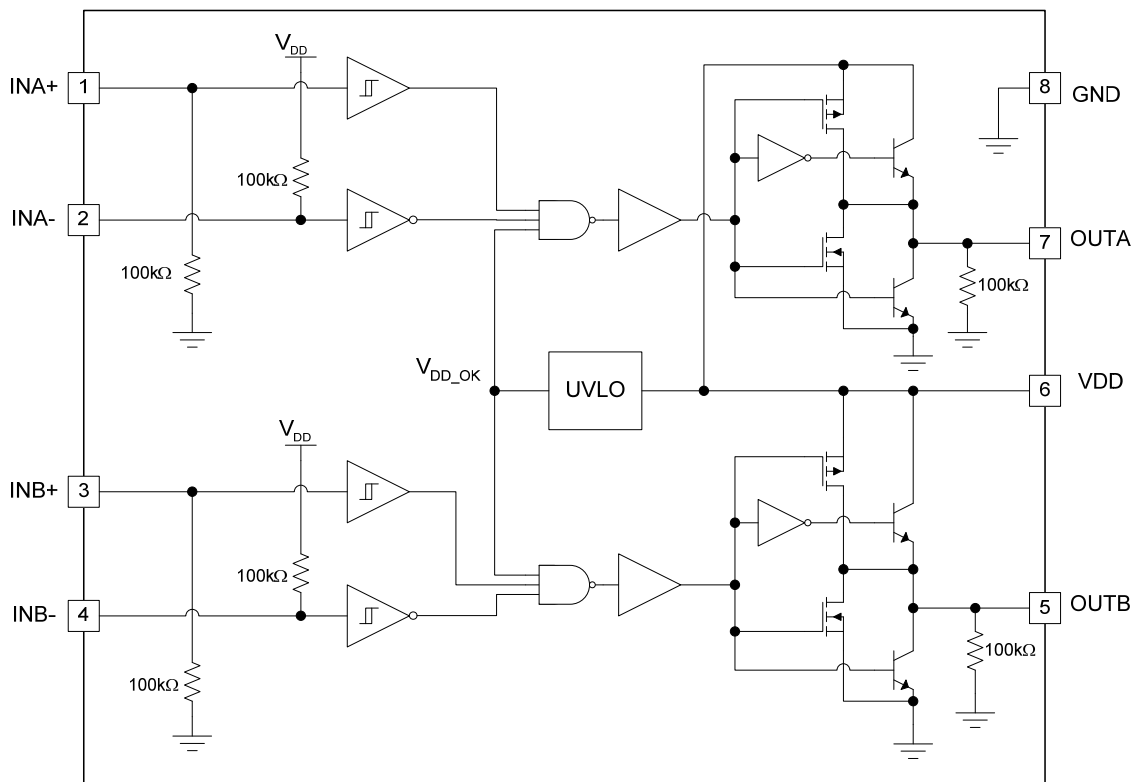

Figure 8. FAN3229 Block Diagram

Absolute Maximum Ratings

Stresses exceeding the absolute maximum ratings may damage the device. The device may not function or be operable above the recommended operating conditions and stressing the parts to these levels is not recommended. In addition, extended exposure to stresses above the recommended operating conditions may affect device reliability. The absolute maximum ratings are stress ratings only.

Symbol	Parameter	Min.	Max.	Unit
V _{DD}	VDD to PGND	-0.3	20.0	V
V _{EN}	ENA and ENB to GND	GND - 0.3	V _{DD} + 0.3	V
V _{IN}	INA, INA+, INA-, INB, INB+ and INB- to GND	GND - 0.3	V _{DD} + 0.3	V
V _{OUT}	OUTA and OUTB to GND	GND - 0.3	V _{DD} + 0.3	V
T _L	Lead Soldering Temperature (10 Seconds)		+260	°C
T _J	Junction Temperature	-55	+150	°C
T _{STG}	Storage Temperature	-65	+150	°C

Recommended Operating Conditions

The Recommended Operating Conditions table defines the conditions for actual device operation. Recommended operating conditions are specified to ensure optimal performance to the datasheet specifications. Fairchild does not recommend exceeding them or designing to Absolute Maximum Ratings.

Symbol	Parameter	Min.	Max.	Unit
V _{DD}	Supply Voltage Range	4.5	18.0	V
V _{EN}	Enable Voltage ENA and ENB	0	V _{DD}	V
V _{IN}	Input Voltage INA, INA+, INA-, INB, INB+ and INB-	0	V _{DD}	V
T _A	Operating Ambient Temperature	-40	+125	°C

Electrical Characteristics

Unless otherwise noted, $V_{DD}=12\text{ V}$, $T_J=-40^\circ\text{C}$ to $+125^\circ\text{C}$. Currents are defined as positive into the device and negative out of the device.

Symbol	Parameter	Conditions	Min.	Typ.	Max.	Unit
Supply						
V_{DD}	Operating Range		4.5		18.0	V
I_{DD}	Supply Current Inputs / EN Not Connected	TTL		0.75	1.20	mA
		CMOS ⁽⁹⁾		0.65	1.05	mA
V_{ON}	Turn-On Voltage	INA=ENA= V_{DD} , INB=ENB=0 V	3.5	3.9	4.3	V
V_{OFF}	Turn-Off Voltage	INA=ENA= V_{DD} , INB=ENB=0 V	3.3	3.7	4.1	V
FAN322xCMX_F085, FAN322xTMX_F085 (Automotive-Qualified Versions)						
V_{ON}	Turn-On Voltage ⁽¹⁴⁾	INA=ENA= V_{DD} , INB=ENB=0 V	3.3	3.9	4.5	V
V_{OFF}	Turn-Off Voltage ⁽¹⁴⁾	INA=ENA= V_{DD} , INB=ENB=0 V	3.1	3.7	4.3	V
Inputs (FAN322xT)⁽¹⁰⁾						
V_{INL_T}	INx Logic Low Threshold		0.8	1.2		V
V_{INH_T}	INx Logic High Threshold			1.6	2.0	V
V_{HYS_T}	TTL Logic Hysteresis Voltage		0.2	0.4	0.8	V
FAN322xT						
I_{IN+}	Non-Inverting Input Current	IN from 0 to V_{DD}	-1		175	μA
I_{IN-}	Inverting Input Current	IN from 0 to V_{DD}	-175		1	μA
FAN322xTMX_F085 (Automotive-Qualified Versions)						
I_{INx_T}	Non-inverting Input Current ⁽¹⁴⁾	IN=0 V	-1.5		1.5	μA
I_{INx_T}	Non-inverting Input Current ⁽¹⁴⁾	IN= V_{DD}	90	120	175.0	μA
I_{INx_T}	Inverting Input Current ⁽¹⁴⁾	IN=0 V	-175	-120	-90	μA
I_{INx_T}	Inverting Input Current ⁽¹⁴⁾	IN= V_{DD}	-1.5		1.5	μA
Inputs (FAN322xC)⁽¹⁰⁾						
V_{INL_C}	INx Logic Low Threshold		30	38		% V_{DD}
V_{INH_C}	INx Logic High Threshold			55	70	% V_{DD}
V_{HYS_C}	CMOS Logic Hysteresis Voltage			17		% V_{DD}
FAN322xC						
I_{IN+}	Non-Inverting Input Current	IN from 0 to V_{DD}	-1		175	μA
I_{IN-}	Inverting Input Current	IN from 0 to V_{DD}	-175		1	μA
FAN322xCMX_F085 (Automotive-Qualified Versions)						
I_{INx_T}	Non-inverting Input Current ⁽¹⁴⁾	IN=0 V	-1.5		1.5	μA
I_{INx_T}	Non-inverting Input Current ⁽¹⁴⁾	IN= V_{DD}	90	120	175.0	μA
I_{INx_T}	Inverting Input Current ⁽¹⁴⁾	IN=0 V	-175	-120	-90	μA
I_{INx_T}	Inverting Input Current ⁽¹⁴⁾	IN= V_{DD}	-1.5		1.5	μA
ENABLE (FAN3226C, FAN3226T, FAN3227C, FAN3227T)						
V_{ENL}	Enable Logic Low Threshold	EN from 5 V to 0 V	0.8	1.2		V
V_{ENH}	Enable Logic High Threshold	EN from 0 V to 5 V		1.6	2.0	V
V_{HYS_T}	TTL Logic Hysteresis Voltage ⁽¹¹⁾			0.4		V
R_{PU}	Enable Pull-up Resistance ⁽¹¹⁾			100		k Ω

Continued on the following page...

Electrical Characteristics (Continued)

Unless otherwise noted, $V_{DD}=12\text{ V}$, $T_J=-40^\circ\text{C}$ to $+125^\circ\text{C}$. Currents are defined as positive into the device and negative out of the device.

Symbol	Parameter	Conditions	Min.	Typ.	Max.	Unit
ENABLE (FAN3226C, FAN3226T, FAN3227C, FAN3227T) (continued)						
t_{D3}	EN to Output Propagation Delay ⁽¹²⁾	0 V to 5 V EN, 1 V/ns Slew Rate	10	19	34	ns
t_{D4}		5 V to 0 V EN, 1 V/ns Slew Rate	10	18	32	ns
FAN3226CMX, FAN3226TMX, FAN3227CMX, FAN3227TMX_F085 (Automotive-Qualified Versions)						
t_{D3}	EN to Output Propagation Delay ^{(12),(14)}	0 V to 5 V EN, 1 V/ns Slew Rate	8	19	35	ns
t_{D4}		5 V to 0 V EN, 1 V/ns Slew Rate	8	18	35	ns
Outputs						
I_{SINK}	OUT Current, Mid-Voltage, Sinking ⁽¹¹⁾	OUT at $V_{DD}/2$, $C_{LOAD}=0.1\ \mu\text{F}$, $f=1\ \text{kHz}$		2.4		A
I_{SOURCE}	OUT Current, Mid-Voltage, Sourcing ⁽¹¹⁾	OUT at $V_{DD}/2$, $C_{LOAD}=0.1\ \mu\text{F}$, $f=1\ \text{kHz}$		-1.6		A
I_{PK_SINK}	OUT Current, Peak, Sinking ⁽¹¹⁾	$C_{LOAD}=0.1\ \mu\text{F}$, $f=1\ \text{kHz}$		3		A
I_{PK_SOURCE}	OUT Current, Peak, Sourcing ⁽¹¹⁾	$C_{LOAD}=0.1\ \mu\text{F}$, $f=1\ \text{kHz}$		-3		A
t_{RISE}	Output Rise Time ⁽¹³⁾	$C_{LOAD}=1000\ \text{pF}$		12	22	ns
t_{FALL}	Output Fall Time ⁽¹³⁾	$C_{LOAD}=1000\ \text{pF}$		9	17	ns
I_{RVS}	Output Reverse Current Withstand ⁽¹¹⁾			500		mA
FAN322xT, FAN322xC						
t_{D1}	Output Propagation Delay, CMOS Inputs ⁽¹³⁾	CMOS Input	7	15	30	ns
t_{D2}		CMOS Input	6	15	29	
t_{D1}	Output Propagation Delay, TTL Inputs ⁽¹³⁾	TTL Input	10	19	34	ns
t_{D2}		TTL Input	10	18	32	
t_{DEL_MATCH}	Propagation Matching Between Channels ⁽¹⁴⁾	INA=INB, OUTA and OUTB at 50% Point		1	2	ns
FAN322xTMX_F085, FAN322xCMX_F085 (Automotive-Qualified Versions)						
t_{D1}	Output Propagation Delay, CMOS Inputs ^{(13),(14)}	CMOS Input	7	15	33	ns
t_{D2}		CMOS Input	6	15	42	
t_{D1}	Output Propagation Delay, TTL Inputs ^{(13),(14)}	TTL Input	9	19	34	ns
t_{D2}		TTL Input	9	18	32	
t_{DEL_MATCH}	Propagation Matching Between Channels ⁽¹⁴⁾	INA=INB, OUTA and OUTB at 50% Point		2	4	ns
V_{OH}	High Level Output Voltage ⁽¹⁴⁾	$V_{OH}=V_{DD}-V_{OUT}$, $I_{OUT}=-1\ \text{mA}$		15	35	mV
V_{OL}	Low Level Output Voltage ⁽¹⁴⁾	$I_{OUT}=1\ \text{mA}$		10	25	mV

Notes:

9. Lower supply current due to inactive TTL circuitry.
10. EN inputs have TTL thresholds; refer to the ENABLE section.
11. Not tested in production.
12. See Timing Diagrams of Figure 11 and Figure 12.
13. See Timing Diagrams of Figure 9 and Figure 10.
14. Apply to only F085 Version

Timing Diagrams



Figure 9. Non-Inverting (EN HIGH or Floating)



Figure 10. Inverting (EN HIGH or Floating)



Figure 11. Non-Inverting (IN HIGH)



Figure 12. Inverting (IN LOW)

Typical Performance Characteristics

Typical characteristics are provided at 25°C and $V_{DD}=12\text{ V}$ unless otherwise noted.

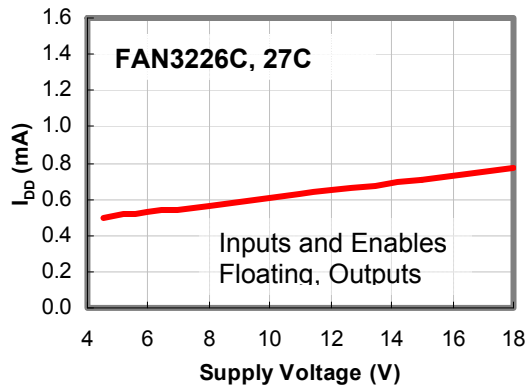

Figure 13. I_{DD} (Static) vs. Supply Voltage⁽¹⁵⁾

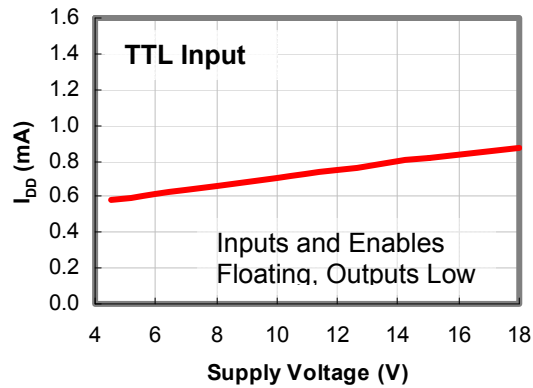

Figure 14. I_{DD} (Static) vs. Supply Voltage⁽¹⁵⁾

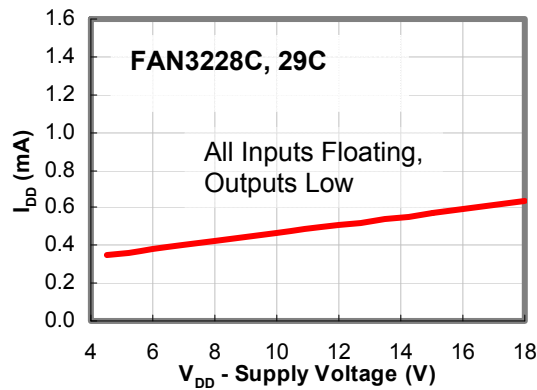

Figure 15. I_{DD} (Static) vs. Supply Voltage⁽¹⁵⁾



Figure 16. I_{DD} (No-Load) vs. Frequency



Figure 17. I_{DD} (No-Load) vs. Frequency

Typical Performance Characteristics

Typical characteristics are provided at 25°C and $V_{DD}=12\text{ V}$ unless otherwise noted.



Figure 18. I_{DD} (1 nF Load) vs. Frequency



Figure 19. I_{DD} (1 nF Load) vs. Frequency



Figure 20. I_{DD} (Static) vs. Temperature⁽¹⁵⁾



Figure 21. I_{DD} (Static) vs. Temperature⁽¹⁵⁾



Figure 22. I_{DD} (Static) vs. Temperature⁽¹⁵⁾

Typical Performance Characteristics

Typical characteristics are provided at 25°C and $V_{DD}=12\text{ V}$ unless otherwise noted.



Figure 23. Input Thresholds vs. Supply Voltage

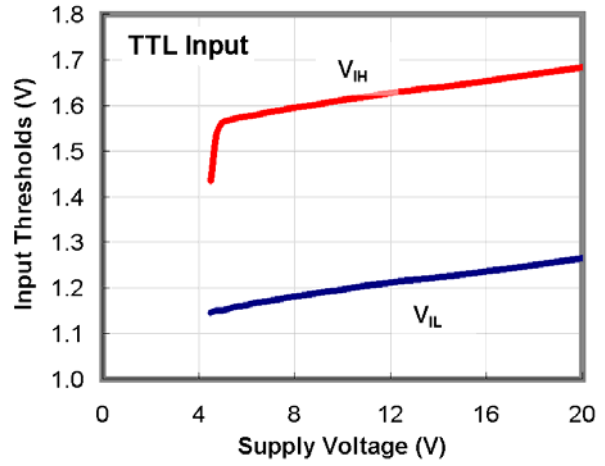

Figure 24. Input Thresholds vs. Supply Voltage



Figure 25. Input Threshold % vs. Supply Voltage



Figure 26. Input Thresholds vs. Temperature

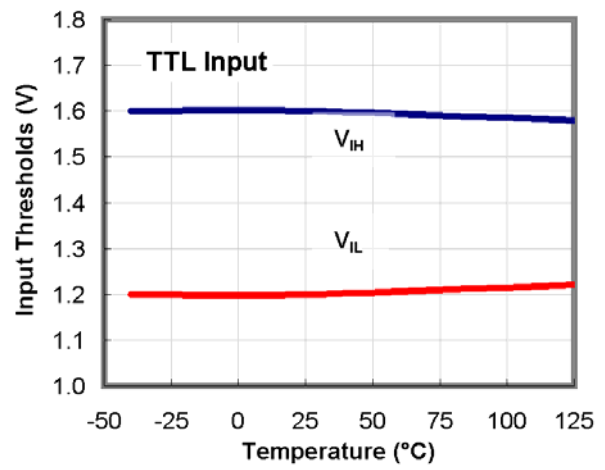

Figure 27. Input Thresholds vs. Temperature

Typical Performance Characteristics

Typical characteristics are provided at 25°C and $V_{DD}=12\text{ V}$ unless otherwise noted.

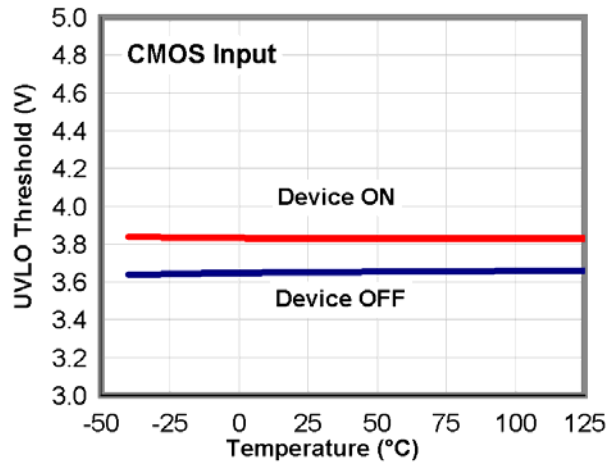

Figure 28. UVLO Thresholds vs. Temperature

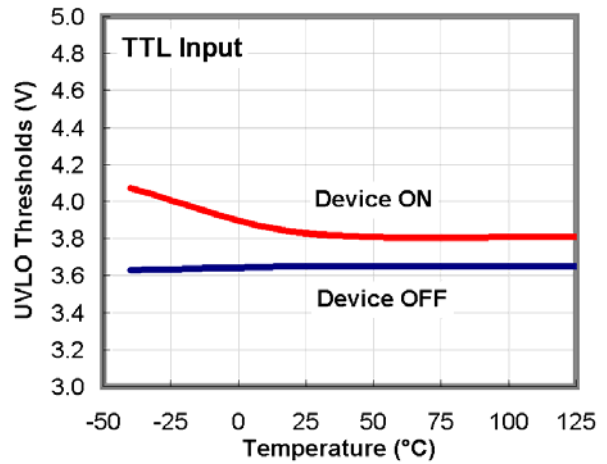

Figure 29. UVLO Threshold vs. Temperature

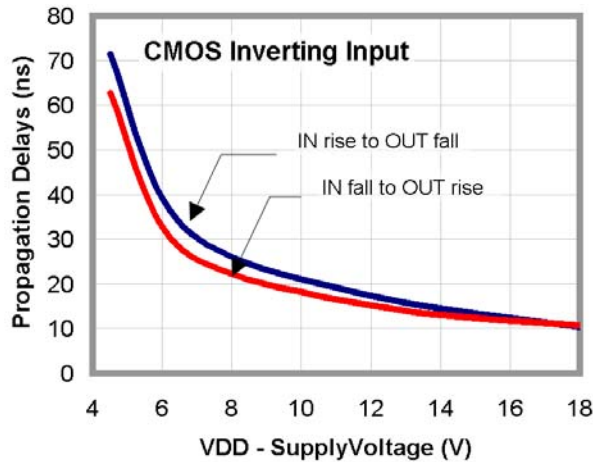

Figure 30. Propagation Delays vs. Supply Voltage

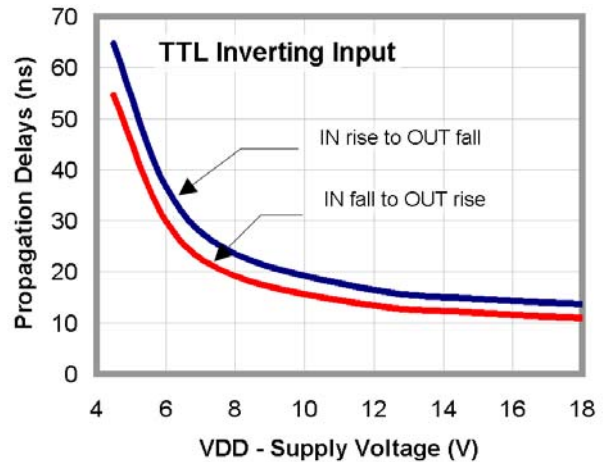

Figure 31. Propagation Delays vs. Supply Voltage

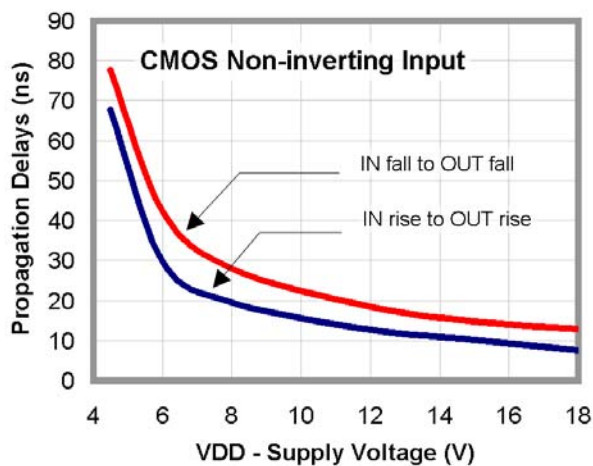

Figure 32. Propagation Delays vs. Supply Voltage

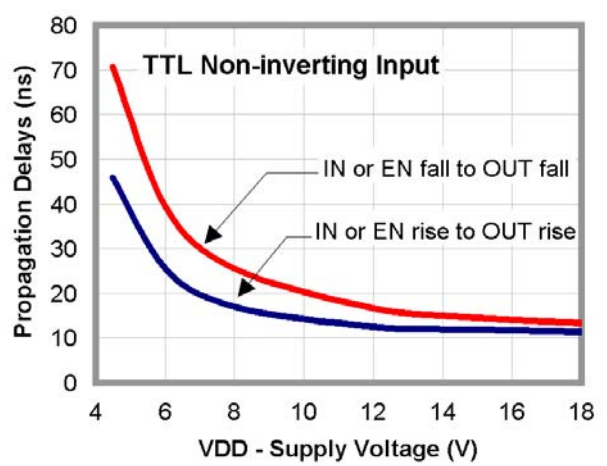

Figure 33. Propagation Delays vs. Supply Voltage

Typical Performance Characteristics

Typical characteristics are provided at 25°C and $V_{DD}=12$ V unless otherwise noted.

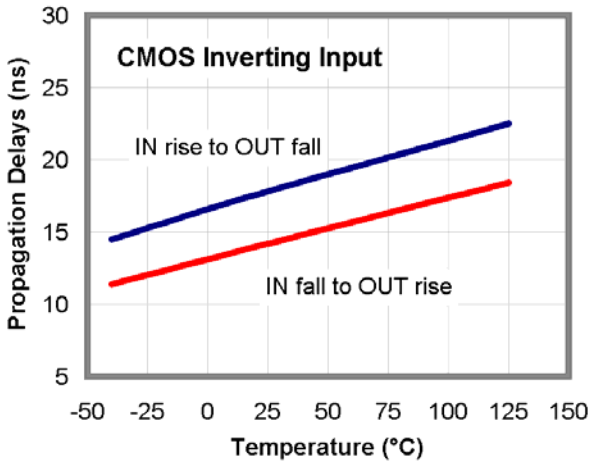

Figure 34. Propagation Delays vs. Temperature

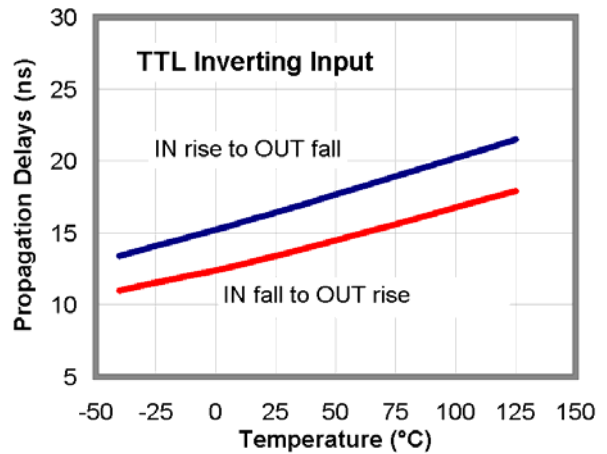

Figure 35. Propagation Delays vs. Temperature

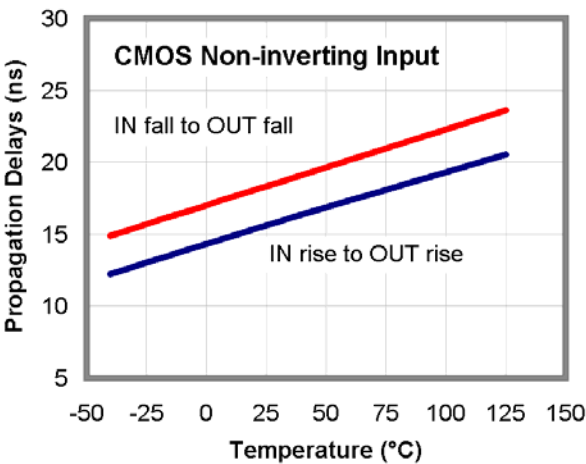

Figure 36. Propagation Delays vs. Temperature

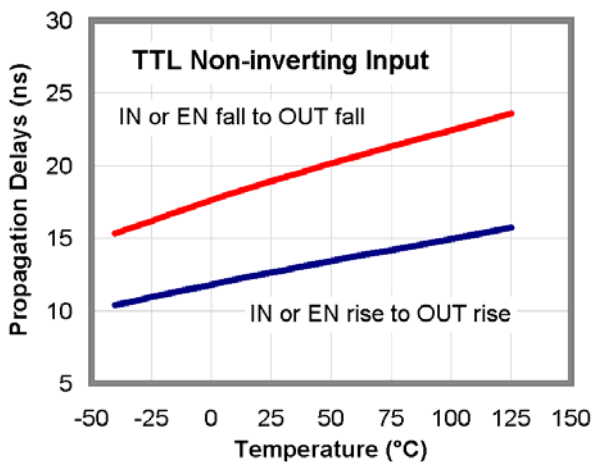

Figure 37. Propagation Delays vs. Temperature

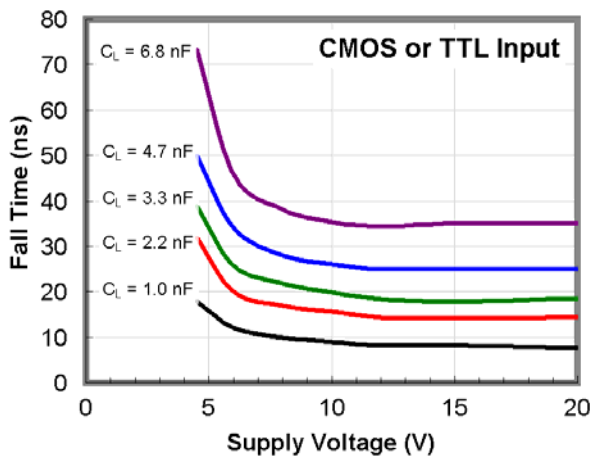

Figure 38. Fall Time vs. Supply Voltage

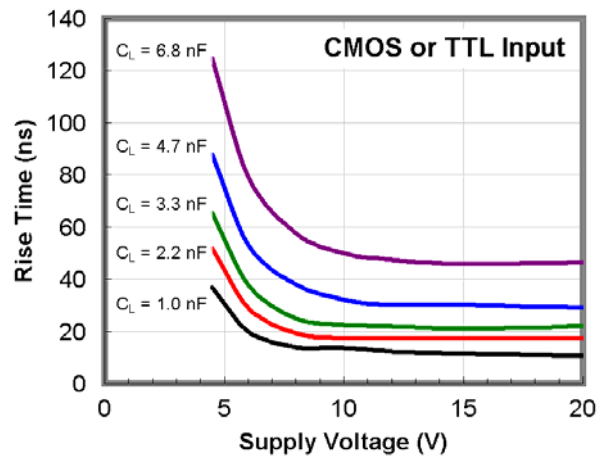

Figure 39. Rise Time vs. Supply Voltage

Typical Performance Characteristics

Typical characteristics are provided at 25°C and $V_{DD}=12\text{ V}$ unless otherwise noted.



Figure 40. Rise and Fall Times vs. Temperature



Figure 41. Rise/Fall Waveforms with 1 nF Load

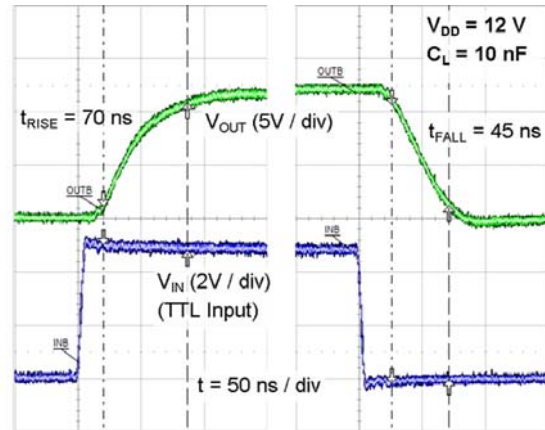

Figure 42. Rise/Fall Waveforms with 10 nF Load

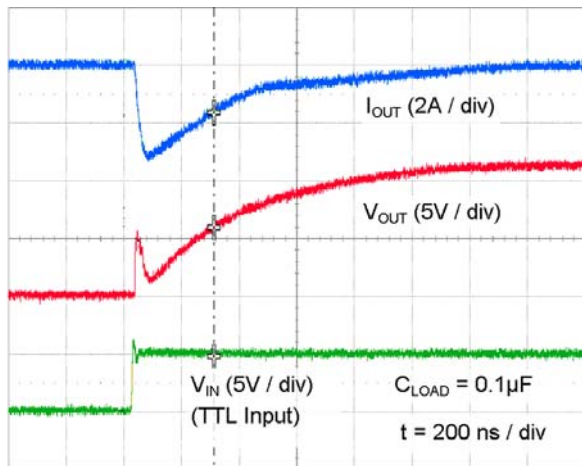

Figure 43. Quasi-Static Source Current with $V_{DD}=12\text{ V}$

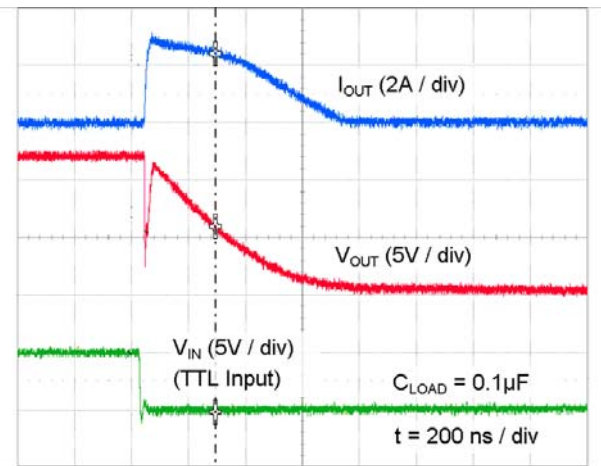

Figure 44. Quasi-Static Sink Current with $V_{DD}=12\text{ V}$

Typical Performance Characteristics

Typical characteristics are provided at 25°C and $V_{DD}=12$ V unless otherwise noted.



Figure 45. Quasi-Static Source Current with $V_{DD}=8$ V



Figure 46. Quasi-Static Sink Current with $V_{DD}=8$ V

Note:

15. For any inverting inputs pulled low, non-inverting inputs pulled high, or outputs driven high, static I_{DD} increases by the current flowing through the corresponding pull-up/down resistor shown in the block diagram.

Test Circuit



Figure 47. Quasi-Static I_{OUT} / V_{OUT} Test Circuit

Applications Information

Input Thresholds

Each member of the FAN322x driver family consists of two identical channels that may be used independently at rated current or connected in parallel to double the individual current capacity. In the FAN3226 and FAN3227, channels A and B can be enabled or disabled independently using ENA or ENB, respectively. The EN pin has TTL thresholds for parts with either CMOS or TTL input thresholds. If ENA and ENB are not connected, an internal pull-up resistor enables the driver channels by default. If the channel A and channel B inputs and outputs are connected in parallel to increase the driver current capacity, ENA and ENB should be connected and driven together.

The FAN322x family offers versions in either TTL or CMOS input thresholds. In the FAN322xT, the input thresholds meet industry-standard TTL-logic thresholds independent of the V_{DD} voltage, and there is a hysteresis voltage of approximately 0.4 V. These levels permit the inputs to be driven from a range of input logic signal levels for which a voltage over 2 V is considered logic high. The driving signal for the TTL inputs should have fast rising and falling edges with a slew rate of 6 V/ μ s or faster, so a rise time from 0 to 3.3 V should be 550 ns or less. With reduced slew rate, circuit noise could cause the driver input voltage to exceed the hysteresis voltage and retrigger the driver input, causing erratic operation.

In the FAN322xC, the logic input thresholds are dependent on the V_{DD} level and, with V_{DD} of 12 V, the logic rising edge threshold is approximately 55% of V_{DD} and the input falling edge threshold is approximately 38% of V_{DD} . The CMOS input configuration offers a hysteresis voltage of approximately 17% of V_{DD} . The CMOS inputs can be used with relatively slow edges (approaching DC) if good decoupling and bypass techniques are incorporated in the system design to prevent noise from violating the input voltage hysteresis window. This allows setting precise timing intervals by fitting an R-C circuit between the controlling signal and the IN pin of the driver. The slow rising edge at the IN pin of the driver introduces a delay between the controlling signal and the OUT pin of the driver.

Static Supply Current

In the I_{DD} (static) typical performance characteristics (see Figure 13 - Figure 15 and Figure 20 - Figure 22), the curve is produced with all inputs / enables floating (OUT is low) and indicates the lowest static I_{DD} current for the tested configuration. For other states, additional current flows through the 100 k Ω resistors on the inputs and outputs shown in the block diagram of each part (see Figure 5 - Figure 8). In these cases, the actual static I_{DD} current is the value obtained from the curves plus this additional current.

MillerDrive™ Gate Drive Technology

FAN322x gate drivers incorporate the MillerDrive™ architecture shown in Figure 48. For the output stage, a combination of bipolar and MOS devices provide large currents over a wide range of supply voltage and temperature variations. The bipolar devices carry the bulk of the current as OUT swings between 1/3 to 2/3 V_{DD} and the MOS devices pull the output to the high or low rail.

The purpose of the MillerDrive™ architecture is to speed up switching by providing high current during the Miller plateau region when the gate-drain capacitance of the MOSFET is being charged or discharged as part of the turn-on / turn-off process.

For applications that have zero voltage switching during the MOSFET turn-on or turn-off interval, the driver supplies high peak current for fast switching even though the Miller plateau is not present. This situation often occurs in synchronous rectifier applications because the body diode is generally conducting before the MOSFET is switched on.

The output pin slew rate is determined by V_{DD} voltage and the load on the output. It is not user adjustable, but a series resistor can be added if a slower rise or fall time at the MOSFET gate is needed.



Figure 48. MillerDrive™ Output Architecture

Under-Voltage Lockout

The FAN322x startup logic is optimized to drive ground-referenced N-channel MOSFETs with an under-voltage lockout (UVLO) function to ensure that the IC starts up in an orderly fashion. When V_{DD} is rising, yet below the 3.9 V operational level, this circuit holds the output low, regardless of the status of the input pins. After the part is active, the supply voltage must drop 0.2 V before the part shuts down. This hysteresis helps prevent chatter when low V_{DD} supply voltages have noise from the power switching. This configuration is not suitable for driving high-side P-channel MOSFETs because the low output voltage of the driver would turn the P-channel MOSFET on with V_{DD} below 3.9 V.

V_{DD} Bypass Capacitor Guidelines

To enable this IC to turn a device on quickly, a local high-frequency bypass capacitor C_{BYP} with low ESR and ESL should be connected between the V_{DD} and GND pins with minimal trace length. This capacitor is in addition to bulk electrolytic capacitance of 10 μ F to 47 μ F commonly found on driver and controller bias circuits.

A typical criterion for choosing the value of C_{BYP} is to keep the ripple voltage on the V_{DD} supply to $\leq 5\%$. This is often achieved with a value ≥ 20 times the equivalent load capacitance C_{EQV} , defined here as Q_{GATE}/V_{DD} . Ceramic capacitors of 0.1 μ F to 1 μ F or larger are common choices, as are dielectrics, such as X5R and X7R with good temperature characteristics and high pulse current capability.

If circuit noise affects normal operation, the value of C_{BYP} may be increased to 50-100 times the C_{EQV} , or C_{BYP} may be split into two capacitors. One should be a larger value, based on equivalent load capacitance, and the other a smaller value, such as 1-10 nF mounted closest to the V_{DD} and GND pins to carry the higher frequency components of the current pulses. The bypass capacitor must provide the pulsed current from both of the driver channels and, if the drivers are switching simultaneously, the combined peak current sourced from the C_{BYP} would be twice as large as when a single channel is switching.

Layout and Connection Guidelines

The FAN3226-26 family of gate drivers incorporates fast-reacting input circuits, short propagation delays, and powerful output stages capable of delivering current peaks over 2 A to facilitate voltage transition times from under 10 ns to over 150 ns. The following layout and connection guidelines are strongly recommended:

- Keep high-current output and power ground paths separate logic and enable input signals and signal ground paths. This is especially critical when dealing with TTL-level logic thresholds at driver inputs and enable pins.
- Keep the driver as close to the load as possible to minimize the length of high-current traces. This reduces the series inductance to improve high-speed switching, while reducing the loop area that can radiate EMI to the driver inputs and surrounding circuitry.
- If the inputs to a channel are not externally connected, the internal 100 k Ω resistors indicated on block diagrams command a low output. In noisy environments, it may be necessary to tie inputs of an unused channel to V_{DD} or GND using short traces to prevent noise from causing spurious output switching.
- Many high-speed power circuits can be susceptible to noise injected from their own output or other external sources, possibly causing output re-triggering. These effects can be obvious if the circuit is tested in breadboard or non-optimal circuit layouts with long input, enable, or output leads. For

best results, make connections to all pins as short and direct as possible.

- The FAN322x is compatible with many other industry-standard drivers. In single input parts with enable pins, there is an internal 100 k Ω resistor tied to V_{DD} to enable the driver by default; this should be considered in the PCB layout.
- The turn-on and turn-off current paths should be minimized, as discussed in the following section.

Figure 49 shows the pulsed gate drive current path when the gate driver is supplying gate charge to turn the MOSFET on. The current is supplied from the local bypass capacitor, C_{BYP} , and flows through the driver to the MOSFET gate and to ground. To reach the high peak currents possible, the resistance and inductance in the path should be minimized. The localized C_{BYP} acts to contain the high peak current pulses within this driver-MOSFET circuit, preventing them from disturbing the sensitive analog circuitry in the PWM controller.

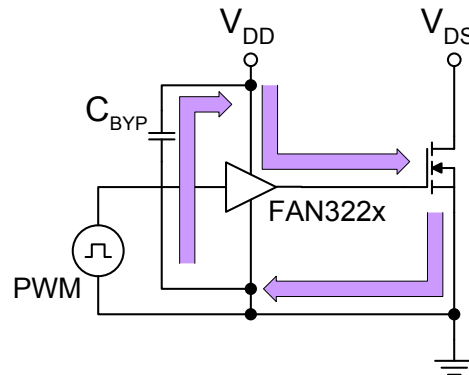

Figure 49. Current Path for MOSFET Turn-on

Figure 50 shows the current path when the gate driver turns the MOSFET off. Ideally, the driver shunts the current directly to the source of the MOSFET in a small circuit loop. For fast turn-off times, the resistance and inductance in this path should be minimized.

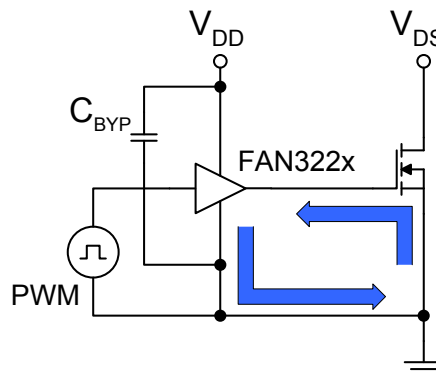

Figure 50. Current Path for MOSFET Turn-off

Truth Table of Logic Operation

The FAN3228/FAN3229 truth table indicates the operational states using the dual-input configuration. In a non-inverting driver configuration, the IN- pin should be a logic low signal. If the IN- pin is connected to logic high, a disable function is realized, and the driver output remains low regardless of the state of the IN+ pin.

IN+	IN-	OUT
0	0	0
0	1	0
1	0	1
1	1	0

In the non-inverting driver configuration in Figure 51, the IN- pin is tied to ground and the input signal (PWM) is applied to IN+ pin. The IN- pin can be connected to logic high to disable the driver and the output remains low, regardless of the state of the IN+ pin.



Figure 51. Dual-Input Driver Enabled, Non-Inverting Configuration

In the inverting driver application in Figure 52, the IN+ pin is tied high. Pulling the IN+ pin to GND forces the output low, regardless of the state of the IN- pin.



Figure 52. Dual-Input Driver Enabled, Inverting Configuration

Operational Waveforms

At power-up, the driver output remains low until the V_{DD} voltage reaches the turn-on threshold. The magnitude of the OUT pulses rises with V_{DD} until steady-state V_{DD} is reached. The non-inverting operation illustrated in Figure 53 shows that the output remains low until the UVLO threshold is reached, the output is in-phase with the input.

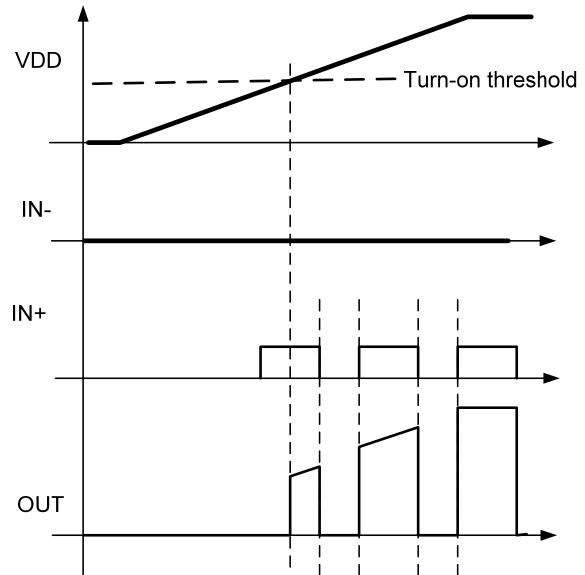

Figure 53. Non-Inverting Startup Waveforms

For the inverting configuration of Figure 52, startup waveforms are shown in Figure 54. With IN+ tied to V_{DD} and the input signal applied to IN-, the OUT pulses are inverted with respect to the input. At power-up, the inverted output remains low until the V_{DD} voltage reaches the turn-on threshold, then it follows the input with inverted phase.

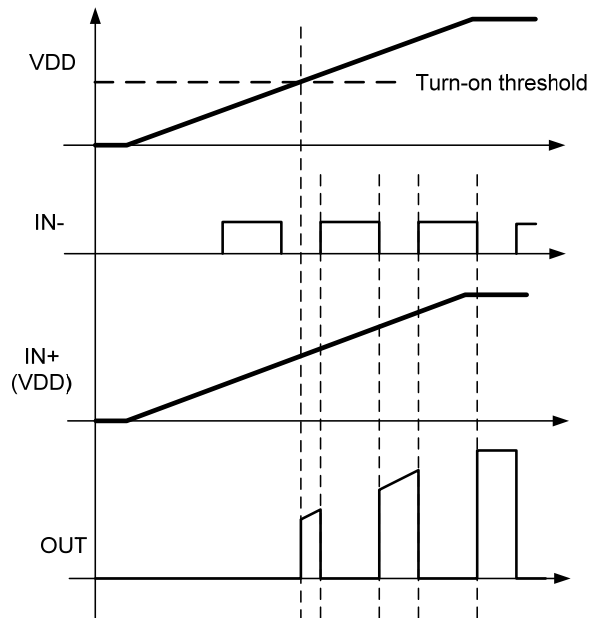

Figure 54. Inverting Startup Waveforms

Thermal Guidelines

Gate drivers used to switch MOSFETs and IGBTs at high frequencies can dissipate significant amounts of power. It is important to determine the driver power dissipation and the resulting junction temperature in the application to ensure that the part is operating within acceptable temperature limits.

The total power dissipation in a gate driver is the sum of two components, P_{GATE} and P_{DYNAMIC} :

$$P_{\text{TOTAL}} = P_{\text{GATE}} + P_{\text{DYNAMIC}} \quad (1)$$

Gate Driving Loss: The most significant power loss results from supplying gate current (charge per unit time) to switch the load MOSFET on and off at the switching frequency. The power dissipation that results from driving a MOSFET at a specified gate-source voltage, V_{GS} , with gate charge, Q_{G} , at switching frequency, f_{SW} , is determined by:

$$P_{\text{GATE}} = Q_{\text{G}} \cdot V_{\text{GS}} \cdot f_{\text{SW}} \cdot n \quad (2)$$

n is the number of driver channels in use (1 or 2).

Dynamic Pre-drive / Shoot-through Current: A power loss resulting from internal current consumption under dynamic operating conditions, including pin pull-up / pull-down resistors, can be obtained using the “ I_{DD} (No-Load) vs. Frequency” graphs in Typical Performance Characteristics to determine the current I_{DYNAMIC} drawn from V_{DD} under actual operating conditions:

$$P_{\text{DYNAMIC}} = I_{\text{DYNAMIC}} \cdot V_{\text{DD}} \cdot n \quad (3)$$

Once the power dissipated in the driver is determined, the driver junction rise with respect to circuit board can be evaluated using the following thermal equation, assuming Ψ_{JB} was determined for a similar thermal design (heat sinking and air flow):

$$T_{\text{J}} = P_{\text{TOTAL}} \cdot \Psi_{\text{JB}} + T_{\text{B}} \quad (4)$$

where:

T_{J} = driver junction temperature

Ψ_{JB} = (psi) thermal characterization parameter relating temperature rise to total power dissipation

T_{B} = board temperature in location defined in Note 2 under Thermal Resistance table.

In the forward converter with synchronous rectifier shown in the typical application diagrams, the FDMS8660S is a reasonable MOSFET selection. The gate charge for each SR MOSFET would be 60 nC with $V_{\text{GS}} = V_{\text{DD}} = 7\text{V}$. At a switching frequency of 500 kHz, the total power dissipation is:

$$P_{\text{GATE}} = 60 \text{ nC} \cdot 7 \text{ V} \cdot 500 \text{ kHz} \cdot 2 = 0.42 \text{ W} \quad (5)$$

$$P_{\text{DYNAMIC}} = 3 \text{ mA} \cdot 7 \text{ V} \cdot 2 = 0.042 \text{ W} \quad (6)$$

$$P_{\text{TOTAL}} = 0.46 \text{ W} \quad (7)$$

The SOIC-8 has a junction-to-board thermal characterization parameter of $\Psi_{\text{JB}} = 43^\circ\text{C/W}$. In a system application, the localized temperature around the device is a function of the layout and construction of the PCB along with airflow across the surfaces. To ensure reliable operation, the maximum junction temperature of the device must be prevented from exceeding the maximum rating of 150°C ; with 80% derating, T_{J} would be limited to 120°C . Rearranging Equation 4 determines the board temperature required to maintain the junction temperature below 120°C :

$$T_{\text{B}} = T_{\text{J}} - P_{\text{TOTAL}} \cdot \Psi_{\text{JB}} \quad (8)$$

$$T_{\text{B}} = 120^\circ\text{C} - 0.46 \text{ W} \cdot 43^\circ\text{C/W} = 100^\circ\text{C} \quad (9)$$

For comparison, replace the SOIC-8 used in the previous example with the 3x3 mm MLP package with $\Psi_{\text{JB}} = 3.5^\circ\text{C/W}$. The 3x3 mm MLP package could operate at a PCB temperature of 118°C , while maintaining the junction temperature below 120°C . This illustrates that the physically smaller MLP package with thermal pad offers a more conductive path to remove the heat from the driver. Consider tradeoffs between reducing overall circuit size with junction temperature reduction for increased reliability.

Typical Application Diagrams

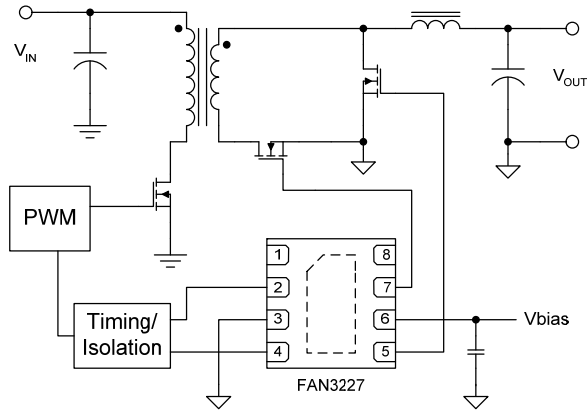

Figure 55. Forward Converter with Synchronous Rectification



Figure 56. Primary-Side Dual Driver in a Push-Pull Converter

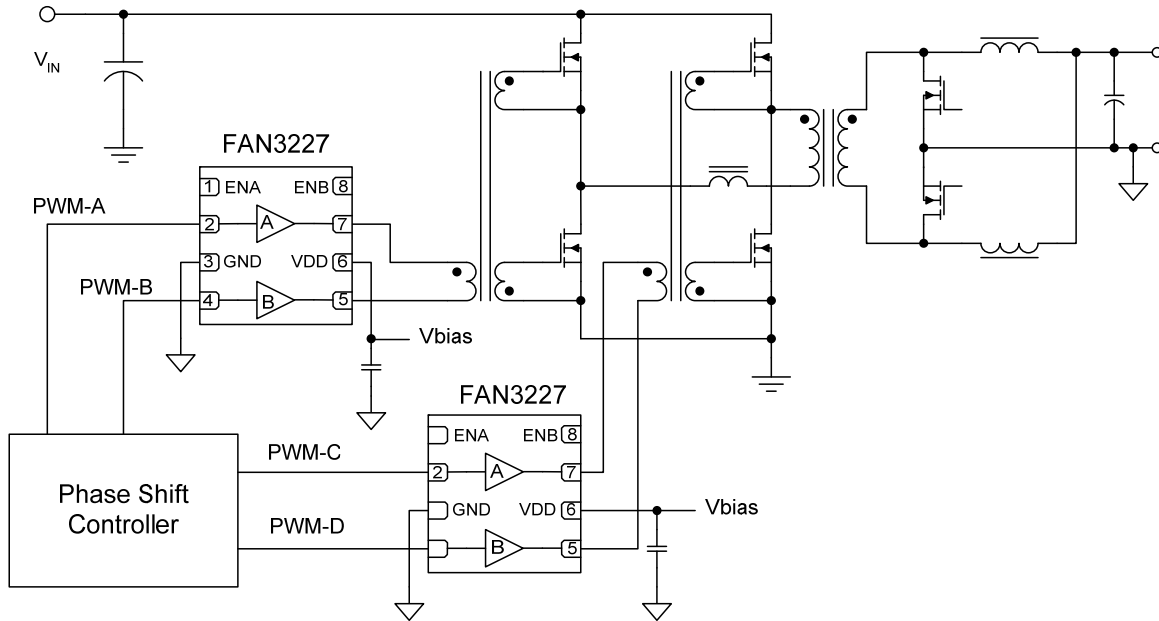

Figure 57. Phase-Shifted Full-Bridge with Two Gate Drive Transformers (Simplified)

Table 1. Related Products

Type	Part Number	Gate Drive ⁽¹⁶⁾ (Sink/Src)	Input Threshold	Logic	Package
Single 1 A	FAN3111C	+1.1 A / -0.9 A	CMOS	Single Channel of Dual-Input/Single-Output	SOT23-5, MLP6
Single 1 A	FAN3111E	+1.1 A / -0.9 A	External ⁽¹⁷⁾	Single Non-Inverting Channel with External Reference	SOT23-5, MLP6
Single 2 A	FAN3100C	+2.5 A / -1.8 A	CMOS	Single Channel of Two-Input/One-Output	SOT23-5, MLP6
Single 2 A	FAN3100T	+2.5 A / -1.8 A	TTL	Single Channel of Two-Input/One-Output	SOT23-5, MLP6
Single 2 A	FAN3180	+2.4 A / -1.6 A	TTL	Single Non-Inverting Channel + 3.3-V LDO	SOT23-5
Dual 2 A	FAN3216T	+2.4 A / -1.6 A	TTL	Dual Inverting Channels	SOIC8
Dual 2 A	FAN3217T	+2.4 A / -1.6 A	TTL	Dual Non-Inverting Channels	SOIC8
Dual 2 A	FAN3226C	+2.4 A / -1.6 A	CMOS	Dual Inverting Channels + Dual Enable	SOIC8, MLP8
Dual 2 A	FAN3226T	+2.4 A / -1.6 A	TTL	Dual Inverting Channels + Dual Enable	SOIC8, MLP8
Dual 2 A	FAN3227C	+2.4 A / -1.6 A	CMOS	Dual Non-Inverting Channels + Dual Enable	SOIC8, MLP8
Dual 2 A	FAN3227T	+2.4 A / -1.6 A	TTL	Dual Non-Inverting Channels + Dual Enable	SOIC8, MLP8
Dual 2 A	FAN3228C	+2.4 A / -1.6 A	CMOS	Dual Channels of Two-Input/One-Output, Pin Config.1	SOIC8, MLP8
Dual 2 A	FAN3228T	+2.4 A / -1.6 A	TTL	Dual Channels of Two-Input/One-Output, Pin Config.1	SOIC8, MLP8
Dual 2 A	FAN3229C	+2.4 A / -1.6 A	CMOS	Dual Channels of Two-Input/One-Output, Pin Config.2	SOIC8, MLP8
Dual 2 A	FAN3229T	+2.4 A / -1.6 A	TTL	Dual Channels of Two-Input/One-Output, Pin Config.2	SOIC8, MLP8
Dual 2 A	FAN3268T	+2.4 A / -1.6 A	TTL	20 V Non-Inverting Channel (NMOS) and Inverting Channel (PMOS) + Dual Enables	SOIC8
Dual 2 A	FAN3278T	+2.4 A / -1.6 A	TTL	30 V Non-Inverting Channel (NMOS) and Inverting Channel (PMOS) + Dual Enables	SOIC8
Dual 4 A	FAN3213T	+2.5 A / -1.8 A	TTL	Dual Inverting Channels	SOIC8
Dual 4 A	FAN3214T	+2.5 A / -1.8 A	TTL	Dual Non-Inverting Channels	SOIC8
Dual 4 A	FAN3223C	+4.3 A / -2.8 A	CMOS	Dual Inverting Channels + Dual Enable	SOIC8, MLP8
Dual 4 A	FAN3223T	+4.3 A / -2.8 A	TTL	Dual Inverting Channels + Dual Enable	SOIC8, MLP8
Dual 4 A	FAN3224C	+4.3 A / -2.8 A	CMOS	Dual Non-Inverting Channels + Dual Enable	SOIC8, MLP8
Dual 4 A	FAN3224T	+4.3 A / -2.8 A	TTL	Dual Non-Inverting Channels + Dual Enable	SOIC8, MLP8
Dual 4 A	FAN3225C	+4.3 A / -2.8 A	CMOS	Dual Channels of Two-Input/One-Output	SOIC8, MLP8
Dual 4 A	FAN3225T	+4.3 A / -2.8 A	TTL	Dual Channels of Two-Input/One-Output	SOIC8, MLP8
Single 9 A	FAN3121C	+9.7 A / -7.1 A	CMOS	Single Inverting Channel + Enable	SOIC8, MLP8
Single 9 A	FAN3121T	+9.7 A / -7.1 A	TTL	Single Inverting Channel + Enable	SOIC8, MLP8
Single 9 A	FAN3122T	+9.7 A / -7.1 A	CMOS	Single Non-Inverting Channel + Enable	SOIC8, MLP8
Single 9 A	FAN3122C	+9.7 A / -7.1 A	TTL	Single Non-Inverting Channel + Enable	SOIC8, MLP8
Dual 12 A	FAN3240	+12.0 A	TTL	Dual-Coil Relay Driver, Timing Config. 0	SOIC8
Dual 12 A	FAN3241	+12.0 A	TTL	Dual-Coil Relay Driver, Timing Config. 1	SOIC8

Notes:16. Typical currents with OUTx at 6 V and V_{DD}=12 V.

17. Thresholds proportional to an externally supplied reference voltage.

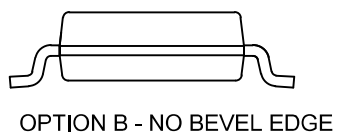
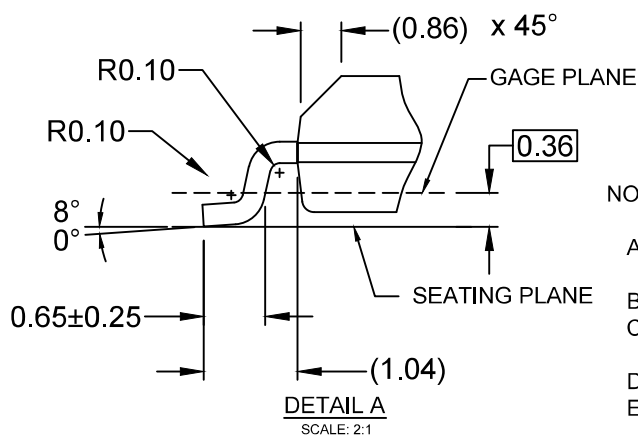
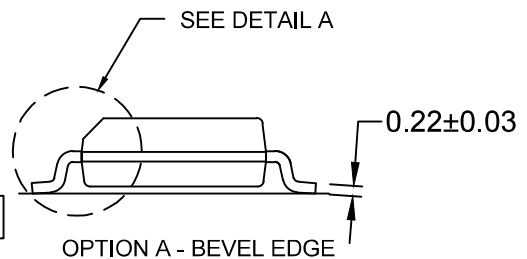
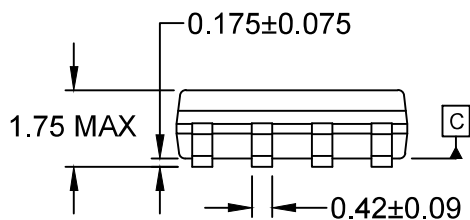
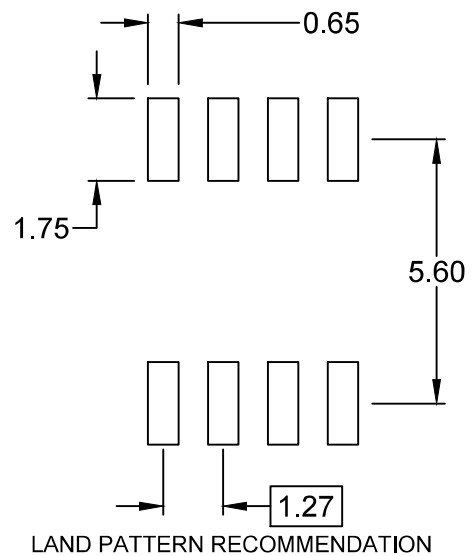
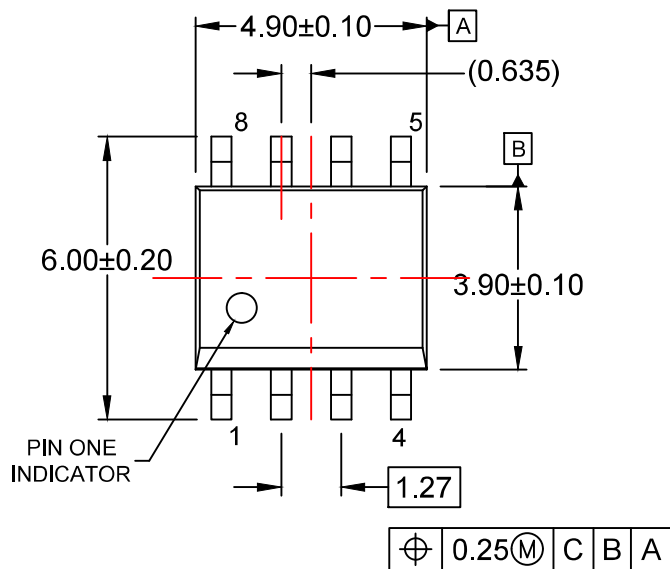

NOTES:

- A) THIS PACKAGE CONFORMS TO JEDEC MS-012, VARIATION AA.
- B) ALL DIMENSIONS ARE IN MILLIMETERS.
- C) DIMENSIONS DO NOT INCLUDE MOLD FLASH OR BURRS.
- D) LANDPATTERN STANDARD: SOIC127P600X175-8M
- E) DRAWING FILENAME: M08Arev16



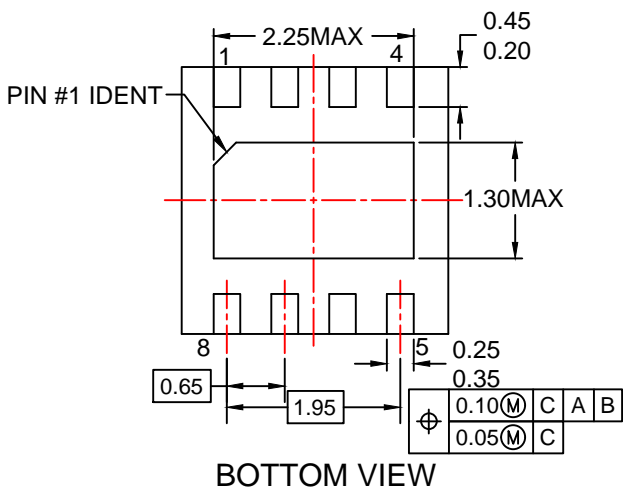
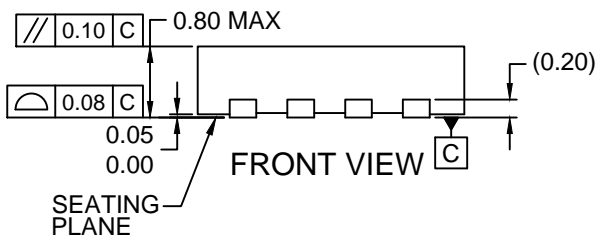

NOTES:

- A. CONFORMS TO JEDEC REGISTRATION MO-229, VARIATION VEEC, DATED 11/2001.
- B. DIMENSIONS ARE IN MILLIMETERS.
- C. DIMENSIONS AND TOLERANCES PER ASME Y14.5M, 2009.
- D. LAND PATTERN RECOMMENDATION IS EXISTING INDUSTRY LAND PATTERN.
- E. DRAWING FILENAME: MKT-MLP08Drev3



ON Semiconductor and  are trademarks of Semiconductor Components Industries, LLC dba ON Semiconductor or its subsidiaries in the United States and/or other countries. ON Semiconductor owns the rights to a number of patents, trademarks, copyrights, trade secrets, and other intellectual property. A listing of ON Semiconductor's product/patent coverage may be accessed at www.onsemi.com/site/pdf/Patent-Marking.pdf. ON Semiconductor reserves the right to make changes without further notice to any products herein. ON Semiconductor makes no warranty, representation or guarantee regarding the suitability of its products for any particular purpose, nor does ON Semiconductor assume any liability arising out of the application or use of any product or circuit, and specifically disclaims any and all liability, including without limitation special, consequential or incidental damages. Buyer is responsible for its products and applications using ON Semiconductor products, including compliance with all laws, regulations and safety requirements or standards, regardless of any support or applications information provided by ON Semiconductor. "Typical" parameters which may be provided in ON Semiconductor data sheets and/or specifications can and do vary in different applications and actual performance may vary over time. All operating parameters, including "Typicals" must be validated for each customer application by customer's technical experts. ON Semiconductor does not convey any license under its patent rights nor the rights of others. ON Semiconductor products are not designed, intended, or authorized for use as a critical component in life support systems or any FDA Class 3 medical devices or medical devices with a same or similar classification in a foreign jurisdiction or any devices intended for implantation in the human body. Should Buyer purchase or use ON Semiconductor products for any such unintended or unauthorized application, Buyer shall indemnify and hold ON Semiconductor and its officers, employees, subsidiaries, affiliates, and distributors harmless against all claims, costs, damages, and expenses, and reasonable attorney fees arising out of, directly or indirectly, any claim of personal injury or death associated with such unintended or unauthorized use, even if such claim alleges that ON Semiconductor was negligent regarding the design or manufacture of the part. ON Semiconductor is an Equal Opportunity/Affirmative Action Employer. This literature is subject to all applicable copyright laws and is not for resale in any manner.

PUBLICATION ORDERING INFORMATION

LITERATURE FULFILLMENT:

Literature Distribution Center for ON Semiconductor
19521 E. 32nd Pkwy, Aurora, Colorado 80011 USA
Phone: 303-675-2175 or 800-344-3860 Toll Free USA/Canada
Fax: 303-675-2176 or 800-344-3867 Toll Free USA/Canada
Email: orderlit@onsemi.com

N. American Technical Support: 800-282-9855 Toll Free
USA/Canada
Europe, Middle East and Africa Technical Support:
Phone: 421 33 790 2910
Japan Customer Focus Center
Phone: 81-3-5817-1050

ON Semiconductor Website: www.onsemi.com
Order Literature: <http://www.onsemi.com/orderlit>
For additional information, please contact your local
Sales Representative