



FEATURES

- RoHS compliant
- Compact size, low profile
- Surface mount design
- Inductance range from 1.0μH to 3.3mH
- Tape & reel packaging
- UL 94V-0
- J-STD-020C reflow
- Custom solutions available

PRODUCT OVERVIEW

The 2800 series is a range of bobbin-wound, surface-mount inductors designed for use in switching power supply, and power line filter circuits. The parts are suitable for any application requiring a high saturation current in a miniature surface-mount footprint.

SELECTION GUIDE

Order Code	Inductance (1kHz, 100mVAc)		DC Current ²	DC Resistance	Q@f MHz		SRF
	Nom.	Min.-Max.			Nom.		
	μH	μH	Max. A	Max. mΩ	Q	F	Typical MHz
28102C	1.0	0.68 - 1.02	15.5	2.6	45.6	1.0	104
28152C	1.5	1.12 - 1.68	12.5	3.6	43.9	1.0	72
28222C	2.2	1.56 - 2.34	11.2	4.4	36.9	1.0	58
28332C	3.3	2.84 - 4.26	9.3	7.5	34.6	1.0	42
28472C	4.7	3.68 - 5.52	8.3	10	33.3	1.0	37
28682C	6.8	5.52 - 8.28	6.8	14	31.2	1.0	29
28103C	10	7.84 - 11.76	5.9	18	31.1	1.0	22.5
28153C	15	12.0 - 18.0	4.77	28	31.0	1.0	17.8
28223C	22	17.7 - 26.5	3.85	42	43.5	1.0	14.4
28333C	33	26.2 - 39.4	3.22	63	42.8	1.0	11.8
28473C	47	39.0 - 58.4	2.66	86	31.5	1.0	10.4
28683C	68	55.4 - 83.0	2.16	122	33.9	1.0	8.6
28104C	100	80.8 - 121.2	1.80	174	21.4	0.8	7.7
28154C	150	121 - 181	1.40	276	20.9	0.8	6.7
28224C	220	178 - 266	1.20	381	18.0	0.8	5.8
28334C	330	266 - 398	0.95	575	30.8	0.8	5.0
28474C	470	383 - 575	0.78	816	31.7	0.8	4.3
28684C	680	548 - 822	0.64	1170	20.4	0.8	4.2
28105C	1000	940 - 1150	0.51	1820	21.0	0.8	3.8
28155C	1500	1390 - 1700	0.41	2620	19.8	0.8	3.4
28225C	2200	1960 - 2400	0.35	3720	15.8	0.8	3.3
28335C	3300	3030 - 3700	0.29	5760	12.8	0.8	3.2

ABSOLUTE MAXIMUM RATINGS

Operating free air temperature range	-40°C to 125°C
Storage temperature range	-40°C to 150°C

SOLDERING INFORMATION¹

Peak reflow solder temperature	245°C
Pin finish	Tin

PACKAGE SPECIFICATIONS

Mechanical Dimensions

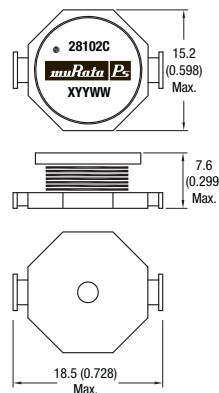

Package weight: 3.9g Typ.
All dimensions in mm (inches)
Dot signifies the innermost turn of the winding

Recommended Footprint Details

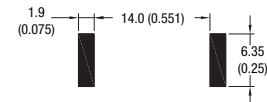

Specifications typical at T_A = 25°C

- For further information, please visit www.murata-ps.com/rohs
- The maximum DC current is the value at which the inductance falls to 75% of its nominal value or when its temperature rise reaches 40°C, whichever is sooner.



INDUCTANCE Vs CURRENT

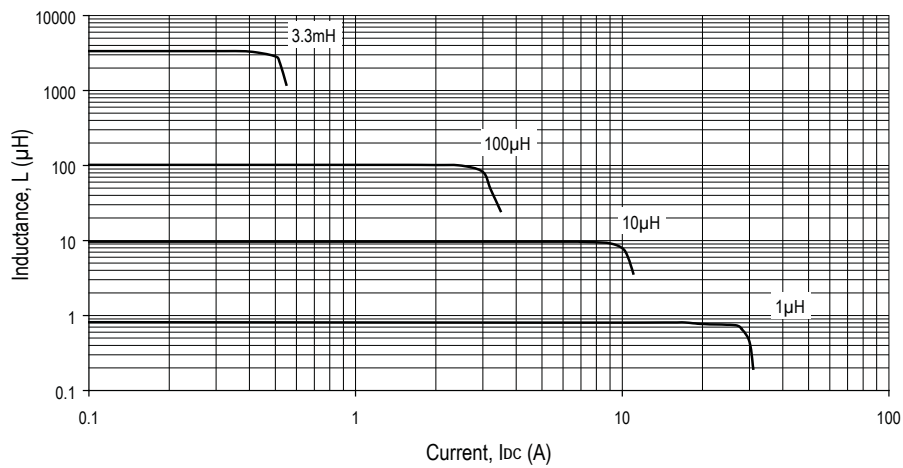

TEMPERATURE Vs CURRENT

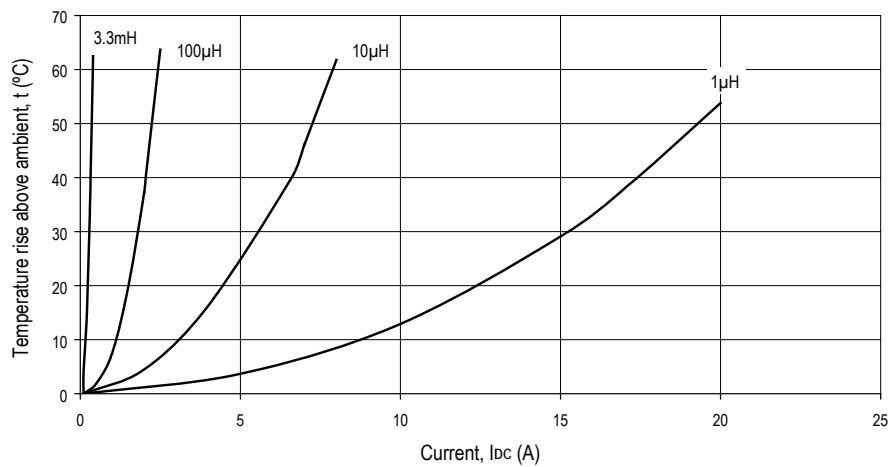

INDUCTANCE Vs FREQUENCY

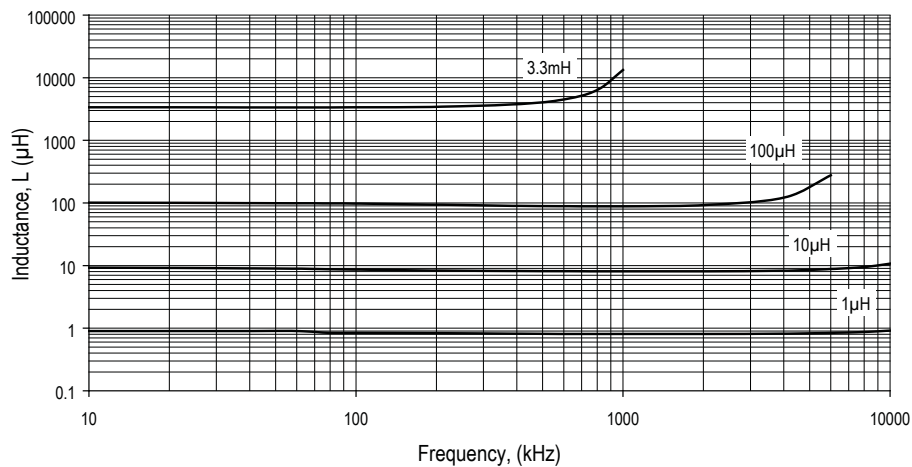

PACKAGE SPECIFICATIONS

Mechanical Dimensions

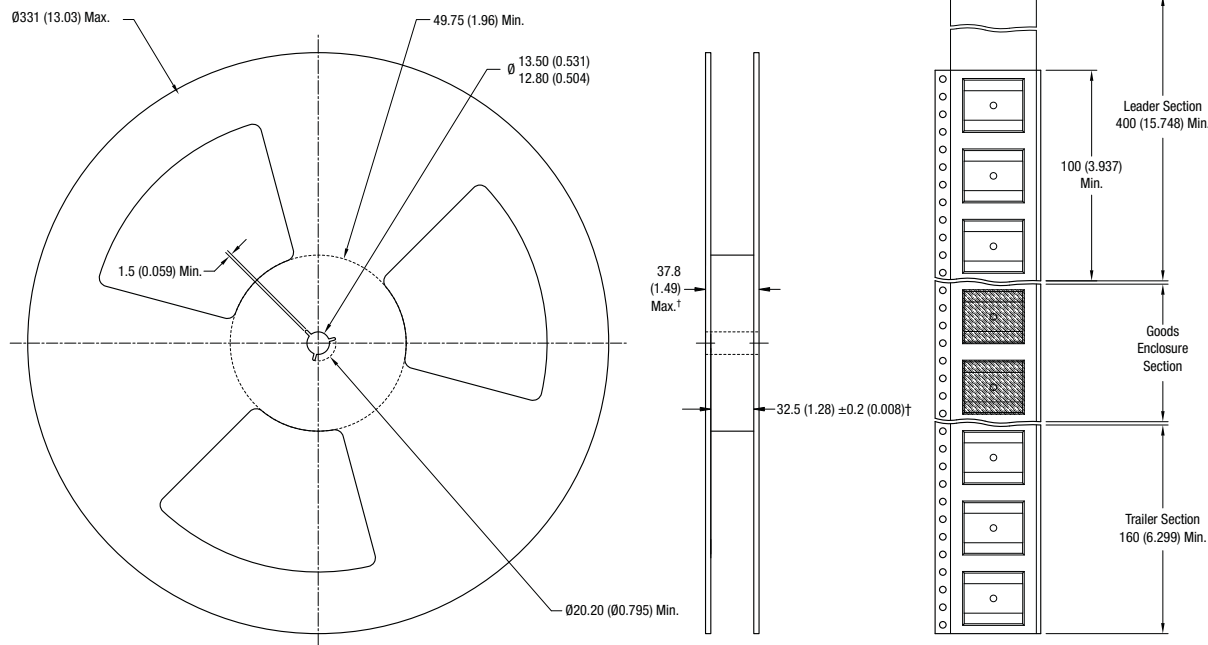

All dimension in mm (inches)
† Measured at hub

Tape Outline Dimensions

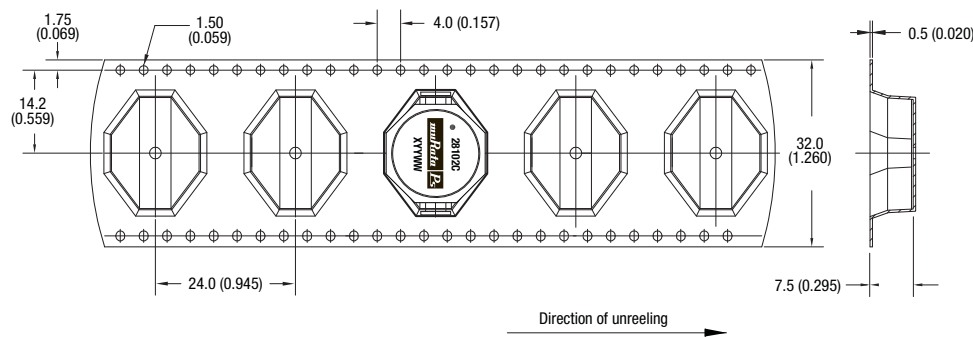

Reel quantity: 350
All dimensions in mm (inches)

Murata Power Solutions, Inc.
11 Cabot Boulevard, Mansfield, MA 02048-1151 U.S.A.
Tel: (508) 339-3000 (800) 233-2765 Fax: (508) 339-6356
www.murata-ps.com email: sales@murata-ps.com ISO 9001 & ISO 14001 REGISTERED

Murata Power Solutions, Inc. makes no representation that the use of its products in the circuits described herein, or the use of other technical information contained herein, will not infringe upon existing or future patent rights. The descriptions contained herein do not imply the granting of licenses to make, use, or sell equipment constructed in accordance therewith. Specifications are subject to change without notice.
© 2009 Murata Power Solutions, Inc.

- USA:** Mansfield (MA), Tel: (508) 339 3000, email: sales@murata-ps.com
- Canada:** Toronto, Tel: (866) 740 1232, email: toronto@murata-ps.com
- UK:** Milton Keynes, Tel: +44 (0)1908 615232, email: mk@murata-ps.com
- France:** Montigny Le Bretonneux, Tel: +33 (0)1 34 60 01 01, email: france@murata-ps.com
- Germany:** München, Tel: +49 (0)89-544334-0, email: ped.munich@murata-ps.com
- Japan:** Tokyo, Tel: 3-3779-1031, email: japan@murata-ps.com
Kyoto, Tel: 81-75-955-7269, email: japan@murata-ps.com
- China:** Shanghai, Tel: +86 215 027 3678, email: shanghai@murata-ps.com
Guangzhou, Tel: +86 208 221 8066, email: guangzhou@murata-ps.com
- Singapore:** Parkway Centre, Tel: +65 6348 9096, email: singapore@murata-ps.com