



Pushing Performance



People | Power | Partnership

## HARTING F.O. Components and Systems

---

## Transforming customer wishes into concrete solutions



The HARTING Technology Group is skilled in the fields of electrical, electronic and optical connection, transmission and networking, as well as in manufacturing, mechatronics and software creation. The Group uses these skills to develop customized solutions and products such as connectors for energy and data transmission applications including, for example, mechanical engineering, rail technology, wind energy plants, factory automation and the telecommunications sector. In addition, HARTING also produces electro-magnetic components for the automobile industry and offers solutions in the field of Enclosures and Shop Systems. The HARTING Group currently comprises 36 subsidiary companies and worldwide distributors employing a total of approximately 3,500 staff.

**We aspire to top performance.**

Connectors ensure functionality. As core elements of electrical and optical wiring, connection and infrastructure technologies, they are essential in enabling the modular construction of devices, machines and systems across a very wide range of industrial applications. Their reliability is a crucial factor guaranteeing smooth functioning in the manufacturing area, in telecommunications, applications in medical technology – in fact, connectors are at work in virtually every conceivable application area. Thanks to the consistent further development of our technologies, customers enjoy investment security and benefit from durable, long term functionality.

**Always at hand, wherever our customers may be.**

Increasing industrialization is creating growing markets characterized by widely diverging demands and requirements. The search for perfection, increasingly efficient processes and reliable technologies is a common factor in all sectors across the globe.

**HARTING** is providing these technologies – in Europe, America and Asia. The **HARTING** professionals at our international subsidiaries engage in close, partnership based interaction with our customers, right from the very early product development phases, in order to realize customer demands and requirements in the best possible manner.

Our people on location form the interface to the centrally coordinated development and production departments. In this way, our customers can rely on consistently high, superior product quality – worldwide.

**Our claim: pushing performance.**

**HARTING** provides more than optimally attuned components. In order to serve our customers with the best possible solutions, **HARTING** is able to contribute a great deal more and play a closely integrative role in the value creation process.

From ready assembled cables through to control racks or ready-to-go control desks: Our aim is to generate the maximum benefits for our customers – without compromise!

**Quality creates reliability – and warrants trust.**

The **HARTING** brand stands for superior quality and reliability – worldwide. The standards we set are the result of consistent, stringent quality management that is subject to regular certifications and audits.

EN ISO 9001, the EU Eco-Audit and ISO 14001:2004 are key elements here. We take a proactive stance to new requirements, which is why **HARTING** ranks among the first companies worldwide to have obtained the new IRIS quality certificate for rail vehicles.





**HARTING technology creates added value for customers.** Technologies by HARTING are at work worldwide. HARTING's presence stands for smoothly functioning systems, powered by intelligent connectors, smart infrastructure solutions and mature network systems. In the course of many years of close, trust-based cooperation with its customers, the HARTING Technology Group has advanced to one of the worldwide leading specialists for connector technology. Extending beyond the basic functionalities demanded, we offer individual customers specific and innovative solutions. These tailored solutions deliver sustained effects, provide investment security and enable customers to achieve strong added value.

**Opting for HARTING opens up an innovative, complex world of concepts and ideas.**

In order to develop connectivity and network solutions serving an exceptionally wide range of connector applications and task scopes in a professional and cost optimized manner, HARTING not only commands the full array of conventional tools and basic technologies. Over and beyond these capabilities, HARTING is constantly harnessing and refining its broad base of knowledge and experience to create new solutions that ensure continuity at the same time. In securing this know-how lead, HARTING draws on a wealth of sources from both in-house research and the world of applications alike.

Salient examples of these sources of innovative knowledge include microstructure technologies, 3D design and construction technology, as well as high temperature

or ultrahigh frequency applications that are finding use in telecommunications or automation networks, in the automotive industry, or in industrial sensor and actuator applications, RFID and wireless technologies, in addition to packaging and housing made of plastics, aluminum or stainless steel.

**HARTING solutions extend across technology boundaries.**

Drawing on the comprehensive resources of the group's technology pool, HARTING devises practical solutions for its customers. Whether this involves industrial networks for manufacturing automation, or hybrid interface solutions for wireless telecommunication infrastructures, 3D circuit carriers with microstructures, or cable assemblies for high-temperature applications in the automotive industry – HARTING technologies offer far more than components, and represent mature, comprehensive solutions attuned to individual customer requirements and wishes. The range covers ready-to-use cable configurations, completely assembled backplanes and board system carriers, as well as fully wired and tested control panels.

In order to ensure the future proof design of RF- and EMC-compatible interface solutions, the central HARTING laboratory (certified to EN 45001) provides simulation tools, as well as experimental, testing and diagnostics facilities all the way through to scanning electron microscopes. In the selection of materials and processes, lifecycle and environmental aspects play a key role, in addition to product and process capability considerations.



**HARTING knowledge is practical know-how generating synergy effects.**

HARTING commands decades of experience with regard to the applications conditions of connectors in telecommunications, computer and network technologies and medical technologies, as well as industrial automation technologies, such as the mechanical engineering and plant engineering areas, in addition to the power generation industry or the transportation sector. HARTING is highly conversant with the specific application areas in all of these technology fields.

The key focus is on applications in every solution approach. In this context, uncompromising, superior quality is our hallmark. Every new solution found will invariably flow back into the HARTING technology pool, thereby enriching our resources. And every new solution we go on to create will draw on this wealth of resources in order to optimize each and every individual solution. In this way, HARTING is synergy in action.

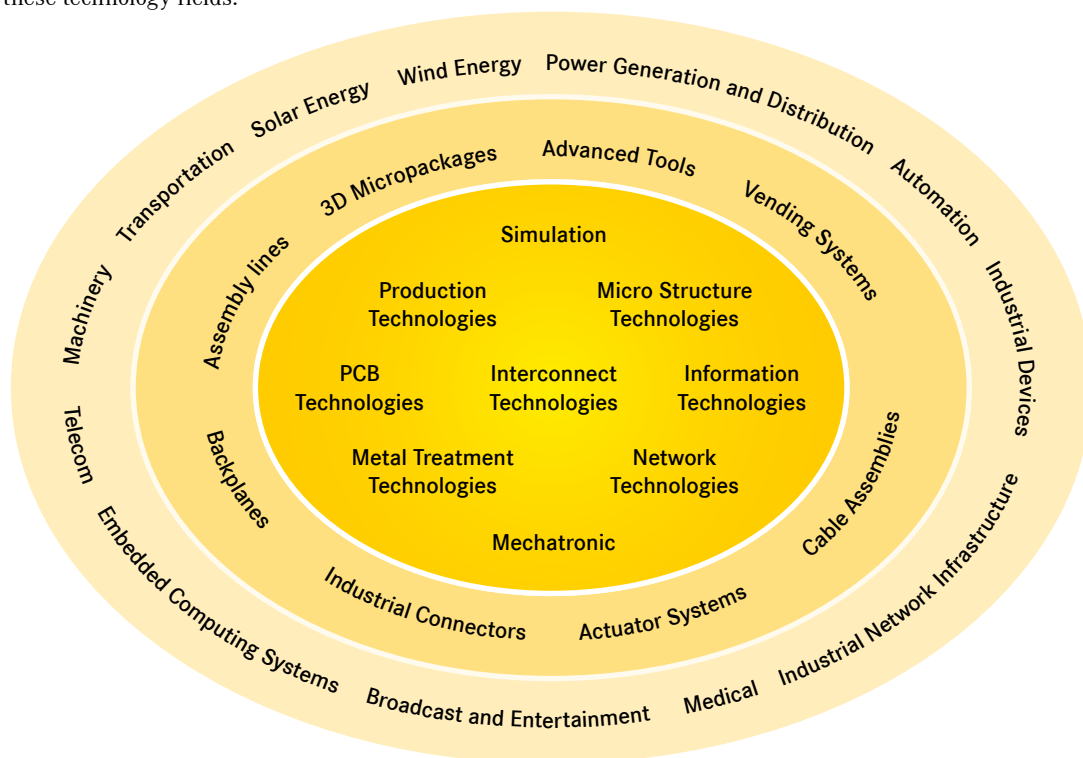

## Field of application

HARTING Industrial Connectors are applicable in a wide variety of electronic and electrical applications. The degree of protection of all hoods and housings is in accordance with International Standard IEC 60 529, EN 60 529.

- Power Utilities
- Robotics
- Chemical Plants
- Machine Tool Controls
- Injection Moulding
- Industrial Instrumentation
- Conveyor Equipment
- Transportation
- and many more.



Certified according to EN ISO 9001 in design/development, production, installation and servicing

## Specifications:

VDE 0110  
Table concerning clearance and creepage distances

VDE 0627  
Connectors and plug devices

**Standards:**  
DIN EN 175 301 - 801, DIN EN 61 984

**Approvals:**  
UL, CSA for inserts  
Nema 4/12 and 4x for hoods and housings

## Note:

Connectors should not be coupled and decoupled under electrical load. Connectors of the same or different series being mounted side by side may be protected against incorrect mating by the use of coding options.

## General information:

It is the user's responsibility to check whether the components illustrated in this catalogue comply with different regulations from those stated in special fields of application which we are unable to foresee.

We reserve the right to modify designs in order to improve quality, keep pace with technological advancement or meet particular requirements in production.

No part of this catalogue may be reproduced in any form (print, photocopy, microfilm or any other process) or processed, duplicated or distributed by means of electronic systems without the prior written consent of HARTING Electric GmbH & Co. KG, Espelkamp. We are bound by the German version only.



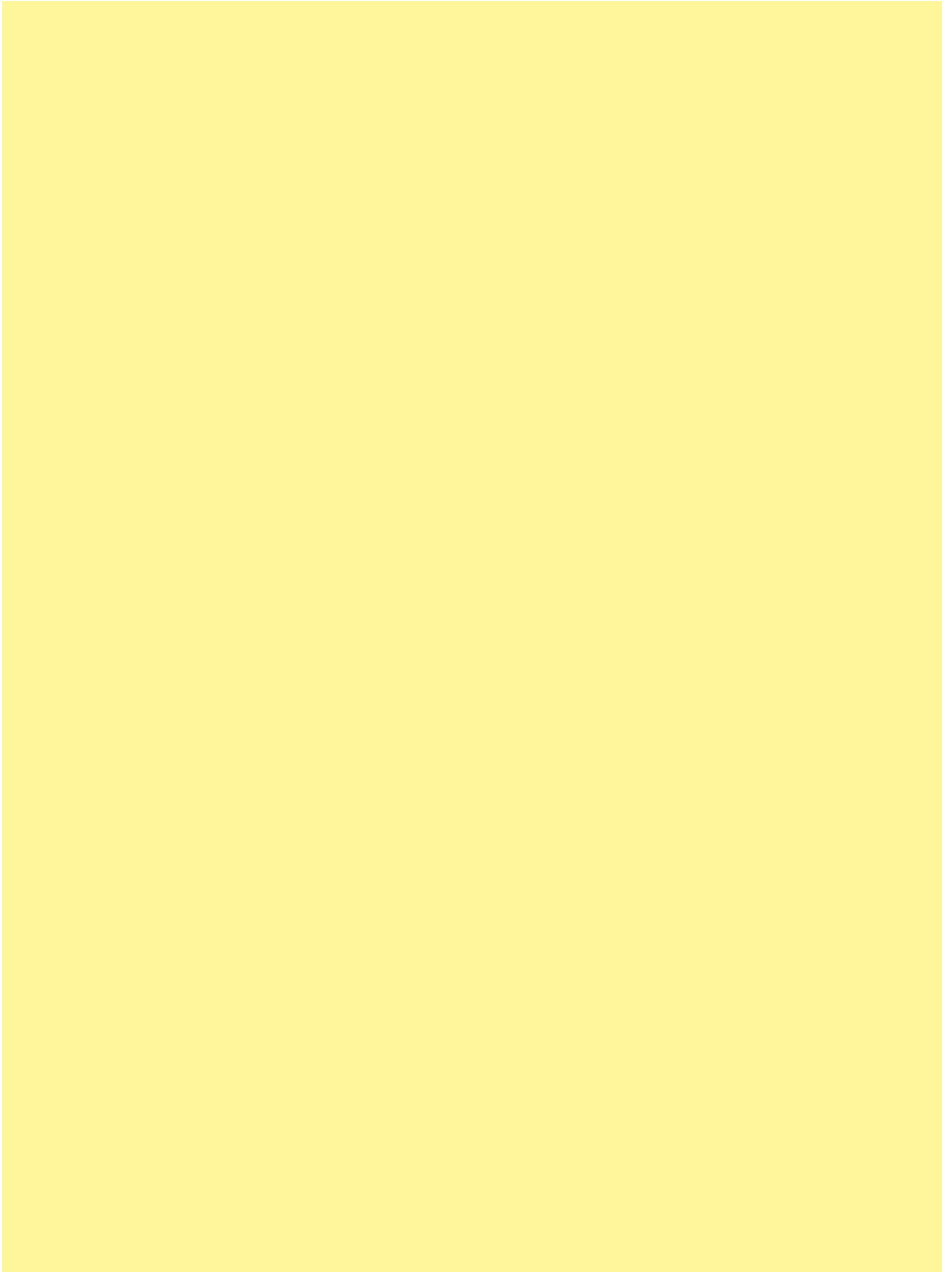



## General

Apart from applications in the field of telecommunications, fibre optic technology is of great importance in the industrial market sector. In telecommunications there are requirements for:

- High transmission capacity
- Low cable attenuation
- No crosstalk

These features are also required in the industrial sector along with the following major considerations:

- Zero susceptibility to electromagnetic interference
- Electrical insulation between transmitter and receiver
- Small cable diameter

Fibre optic communication works by pulses of light. When feeding them in at one end of the fibre optic cable, the pulses are passed to the other end by total internal reflection.

Total internal reflection occurs at the boundary layer between core and cladding by virtue of the different values of optical refractive index ( $n$ ) between the two materials ( $n$  cladding less than  $n$  core).

There are three different types of optical fibres:

		Typical Dimensions Core/Cladding $\varnothing$	Attenuation
Step index (SI) fibre HCS <sup>® 1)</sup> / POF <sup>2)</sup>		200 / 230 $\mu\text{m}$	5 dB/km ... 8 dB/km 0.2 dB/km
Gradient index(GI) fibre		50 / 125 $\mu\text{m}$	2.6 dB/km 3.2 dB/km
Single mode fibre		9 / 125 $\mu\text{m}$	< 0.3 dB/km

optical refractive index profile

The single-mode fibre is mainly used in telecommunications because of its low attenuation and wide bandwidth.

The gradient index fibre and the step fibre with their large core diameters are chiefly used as communication cables in industrial applications due to their easy handling and relatively low costs. The link length ranges from several meters to several kilometers.

Mounting of connectors for gradient fibres is achieved by the use of adhesive.

For POF<sup>2)</sup> or HCS<sup>® 1)</sup> fibres, the crimping technique eases the connector attachment.

With the advanced HARTING quick assembly components, POF-cables can be mounted without the need of special tools. HARTING F.O. systems are designed for gradient index fibres with a core diameter of 50 and 62.5  $\mu\text{m}$  as well as for 200  $\mu\text{m}$  (HCS<sup>® 1)</sup>) and 1 mm (POF<sup>2)</sup>) step index fibres.

The typical operating wavelengths are 660 nm (POF<sup>2)</sup>, HCS<sup>® 1)</sup>), 850 nm (GI, HCS<sup>® 1)</sup>) and 1300 nm (GI).

<sup>1)</sup> HCS<sup>®</sup> (=Hard Clad Silica) is registered trade mark of SpecTran Corporation

<sup>2)</sup> POF = Polymer Optical Fibre

## Dimensioning of F.O. Transmission Systems

For reliable operation of a F.O. data transmission system it is essential that the transmitted optical signals arrive at the receiver with sufficient amplitude. The incident power should at least exceed twice (+ 3 dB) the value of the minimum sensitivity of the receiver. Otherwise, the inherent noise of the system may result in increasing randomly distributed transmission errors in the data transfer. Therefore, in system design the power budget of the optical path has to be checked. The following aspects have to be considered:

- Optical power output of the transmitter  
The optical power generated by the LED does mainly depend on the applied forward current. Typical power levels coupled into the core are:

for glass-fibre ( $\lambda = 850 \text{ nm}$ ):	
50/ 125 $\mu\text{m}$ GI fibre:	80 $\mu\text{W}$
200/ 230 $\mu\text{m}$ SI fibre:	250 $\mu\text{W}$
for Polymer fibre ( $\lambda = 660 \text{ nm}$ ):	
980/1000 $\mu\text{m}$ :	600 $\mu\text{W}$

- Specific attenuation-coefficient of the fibre  
The specific attenuation of optical fibres depends on the wavelength applied and is specified in dB/km. Typical values are:

for glass-fibres ( $\lambda = 850 \text{ nm}$ ):	
50/ 125 $\mu\text{m}$ GI fibre:	---3 dB/km
200/ 230 $\mu\text{m}$ HCS:	---5 dB/km
for polymer fibre ( $\lambda = 660 \text{ nm}$ ):	
980/1000 $\mu\text{m}$ (PMMA):	---0.2 dB/m

The fibre loss usually contributes to the highest amount to the overall transmission index of the optical link.

- Additional interconnections in the cable system  
Interconnections in the optical link create some further attenuation for the travelling optical signals.  
Typical insertion loss is
  - for a spliced connection  $\leq 0.3 \text{ dB}$
  - for a connector-set 0.8 dB ... 0.5 dB
 depending on the type of fibre and the connectors applied.
- Sensitivity of the optical receiver DC-coupled optical receivers, commonly used, with SI-diodes as receiving elements show typical minimum sensitivities of
  - $\leq 3 \mu\text{W}$  at 850 nm (glass fibre systems)
  - $\leq 5 \mu\text{W}$  at 660 nm (polymer fibre systems)
- Temperature dependence and ageing of LED, thermal influence on cable loss  
These items should be taken into account with an amount of 2 dB. Thus, in total a system reserve of 5 dB has to be considered in the link power budget.

## Examples

a) Glass fibre system ( $\lambda = 850 \text{ nm}$ )

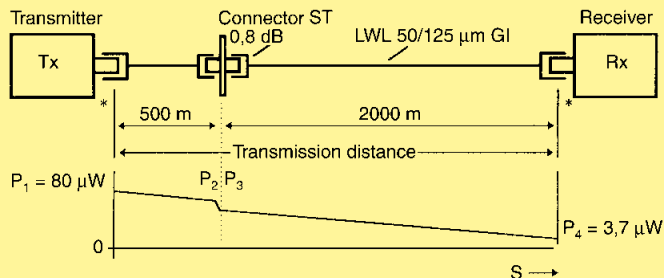

Link budget analysis:

Transmitter:  
 $P_1 = 80 \mu\text{W} = -11 \text{ dBm}$   
 power coupled into fibre core  
 Cable Loss: 2.5 km x 3 dB/km = 7.5 dB  
 Loss per connector set ST = 0.8 dB  
 System reserves (3 dB + 2 dB) = 5.0 dB  
 Total system losses: **13.3 dB**

Incident power at receiver:  $P_4 = -24.3 \text{ dBm} = 3.7 \mu\text{W}$

This satisfies the required minimum-conditions  $\geq 3 \mu\text{W}$

\* The injection- and decoupling-loss at the transmitter- and receiver-ends of the fibre has not additionally to be taken into account as they are already included in the given power ratings of these elements.

b) Polymer fibre system ( $\lambda = 660 \text{ nm}$ )

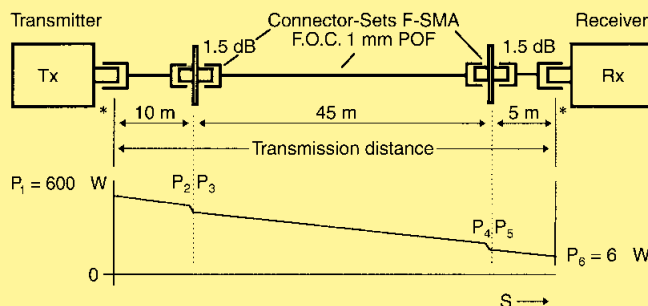

Link budget analysis:

Transmitter:  
 $P_1 = 600 \mu\text{W} = -2.2 \text{ dBm}$   
 power coupled into fibre core  
 Cable loss: 60 m x 0.2 dB/m = 12 dB  
 2 connector-sets F-SMA (2 x 1.5 dB) = 3.0 dB  
 System reserves (3 dB + 2 dB) = 5.0 dB  
 Total system losses: **20.0 dB**

Incident power at receiver:

$P_6 = -22.2 \text{ dBm} = 6.0 \mu\text{W}$

This satisfies the required minimum-conditions  $\geq 5 \mu\text{W}$

Omitting the additional interconnections in the cable (here e.g. the 2 F-SMA connector sets) results in larger maximum transmission distances.

## Conversion Diagram

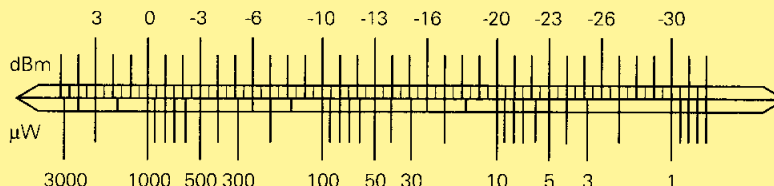

CONTENTS	PAGE
F.O. Transmitter	12
F.O. Receiver	14
Electro-Optic Converters	16

## Features

- The technical specifications for the SERCOS Interface<sup>1)</sup> are fulfilled by the LED 660 nm and the receiver 5 MBit/s.

## Technical characteristics

Standards	DIN EN 60 664-1 DIN EN 61 984
-----------	----------------------------------

### Approvals

### General and limiting values at T = 25 °C

#### Transmitter (LED 850 nm): OPF 370 A

Analog band-width	BWE	80 MHz (I <sub>F</sub> = 100 mA DC)
Optical wave-length	λ	830 nm ... 870 nm
Spektral band-width	Δλ	35 nm
Drive current	I <sub>Fmax</sub>	100 mA
Forward voltage	U <sub>V</sub>	1.8 V ... 2.0 V typ.
Derating at 25 °C	I <sub>F</sub>	0.8 mA/°C
Reverse voltage	U <sub>Rmax</sub>	4 V
Storage temperature		-55 °C ... +115 °C
Operating temperature		-40 °C ... +100 °C

#### Power coupled into fibre (at I<sub>F</sub> = max.)

in 50/125 GI	P <sub>S</sub>	15 μW ... 25 μW typ.
in 200/230 SI	P <sub>S</sub>	650 μW max.

#### Transmitter (LED 650 nm): SFH 757

Analog band-width	BWE	7 MHz (I <sub>F</sub> = 30 mA DC)
Optical wave-length	λ	650 nm
Spektral band-width	Δλ	25 nm
Drive current	I <sub>Fmax</sub>	50 mA
Forward voltage	U <sub>V</sub>	2.1 V typ.
Derating at 25 °C	I <sub>F</sub>	0.93 mA/°C
Reverse voltage	U <sub>Rmax</sub>	4 V
Storage temperature		-40 °C ... +100 °C
Operating temperature		-40 °C ... +80 °C

#### Power coupled into fibre (at I<sub>F</sub> = 10 mA)

in 980/1000 POF	P <sub>S</sub>	150 μW typ.
-----------------	----------------	-------------

for fibre optic transmission

Identification	Part Number	Drawing	Dimensions in mm
<p>F.O. transmitter for PBC mounting receptacle (metall)</p> <p>LED 850 nm OPF 370 A in F-SMA housing in F-ST housing</p> <p>LED 650 nm SFH 757 in F-SMA housing in F-ST housing</p>	<p>20 50 000 1111 20 50 000 1121</p> <p>20 40 000 1112 20 40 000 1122</p>		<p>F-SMA</p> <p>F-ST</p>
<p>F-SMA</p> <p>fixing nut</p>	<p>20 80 000 1072</p>		



## Features

- The technical specifications for the SERCOS Interface<sup>1)</sup> are fulfilled by the LED 660 nm and the receiver 5 MBit/s.

## Technical characteristics

Standards	DIN EN 60 664-1 DIN EN 61 984
-----------	----------------------------------

### Approvals

### General and limiting values at T = 25 °C

#### Receiver (LED 850 nm): OPF 520

Receiver type		0 Mbit/s... 5 Mbit/s (DC coupled)
Supply voltage	V <sub>CC</sub>	4.5 V ... 5.5 V DC
Supply current	I <sub>CC</sub>	10 mA max.
Opt. power input		4 µW ... 100 µW (at 850 nm)
Operating temperature		-40 °C ... +85 °C

#### Receiver (digital): SFH 551

Wave-length		600 nm ... 780 nm
Data rate		5 Mbit/s
Sensitivity		-22 dBm typ.
Optical input power		typ. 6 µW ... 1000 µW (at λ = 650 nm)
Electrical output		TTL, open collector
Operating voltage		5 V DC ±5 %
Operating temperature		-40 °C ... +85 °C

#### Receiver (photo diode): BPX 65

Wave-length		350 nm ... 1100 nm
Switching times		typ. 12 ns
Photo current		typ. 4 µA (t λ = 650 nm; input power 10 µW; reverse voltage 5 V)
Dark current		1 nA typ. (bei V <sub>R</sub> = 20 V)
Capacity		11 pF typ.
Operating temperature		-40 °C ... +85 °C

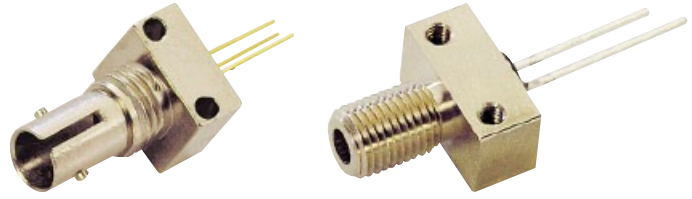

for fibre optic transmission

Identification	Part Number	Drawing	Dimensions in mm
F.O. Receiver for PBC mounting receptacle (metall)			
TTL 5 Mbit/s OPF 520 in F-SMA housing in F-ST housing	20 50 000 2112 20 50 000 2222		<p>The mounted, integrated receivers are suitable for applications in combination with glass fibre as well as polymer fibre.</p> <p>Dimensions of housing see page for F.O. transmitter.</p>
TTL 5 Mbit/s SFH 551 in F-SMA housing in F-ST housing	20 50 000 2116 20 50 000 2226		
Si-PIN photo diode BPX 65 in F-SMA housing in F-ST housing	20 50 000 2119 20 50 000 2229		

## Features

- Electro-optical converters integrated into D-Sub connector shell housings
- Cost-effective solution for fibre optic duplex links
- Transmission distance up to 60 m
- Standard accessories for D-Sub can be applied
- Suitable for 1 mm Ø polymer optical fibres ( $\lambda = 660 \text{ nm}$ )
- Special housing for heavy duty applications is available

## Technical characteristics

Standards	DIN EN 60 664-1 DIN EN 61 984
-----------	----------------------------------

### Approvals

### General and limiting values at $T = 25 \text{ }^\circ\text{C}$

#### Transmitter (LED): SFH 757

Drive current (max.)	$I_{Fmax}$	max. 70 mA
Optical power		
at 20 mA		300 $\mu\text{W}$
at 50 mA		600 $\mu\text{W}$
Wave-length		660 nm
Storage temperature		$-35 \text{ }^\circ\text{C} \dots +100 \text{ }^\circ\text{C}$
Operating temperature		$-30 \text{ }^\circ\text{C} \dots +85 \text{ }^\circ\text{C}$

#### Receiver (digital): SFH 551

Wave-length	600 nm ... 780 nm
Data rate	5 Mbit/s
Sensitivity	-22 dBm typ.
Optical input power	typ. 6 $\mu\text{W}$ ... 1000 $\mu\text{W}$ (at $\lambda = 650 \text{ nm}$ )
Electrical output	TTL, open collector
Operating voltage	5 V DC $\pm 5 \%$
Operating temperature	$-40 \text{ }^\circ\text{C} \dots +85 \text{ }^\circ\text{C}$

#### Receiver (photo diode): SFH 250

Wave-length	400 nm ... 1100 nm
Switching times	10 ns
Photo current	3 $\mu\text{A}$ (at $\lambda = 650 \text{ nm}$ ; input power 10 $\mu\text{W}$ ; reverse voltage 5 V) 4 $\mu\text{A}$ (at $\lambda = 950 \text{ nm}$ ; input power 10 $\mu\text{W}$ ; reverse voltage 5 V)
Dark current	1 nA typ. (at $V_R = 20 \text{ V}$ )
Capacity	11 pF typ.
Operating temperature	$-40 \text{ }^\circ\text{C} \dots +85 \text{ }^\circ\text{C}$

in duplex style for short range transmission with optical fibres ( $\lambda = 660 \text{ nm}$ )



Identification	Part Number	Drawing	Dimensions in mm
<b>F.O. D-Sub T/E female connector</b>  angled 1x SFH 757 / 1x SFH 551  2x pin diode (SFH 250)  straight 1x SFH 757 / 1x SFH 551  Outer dimensions like 9-pin D-Sub female	20 66 009 3811  20 66 009 3813  20 66 009 3812		
<b>F.O. D-Sub male connector</b>     Outer dimensions like 9-pin D-Sub male	20 67 009 3811		Cavities are designed for HARTING POF <sup>1)</sup> ferrules
<b>Ferrule</b>  for 1 mm POF <sup>1)</sup> with cladding gauge 2.2 mm	20 10 001 3232		The mounting/endface-preparation of the ferrule can be achieved by crimping, hot-plate technique or by using adhesive
		The ferrules are snap-mounted into the male connector and can be released with aid of removal tool 09 99 000 0052 (see catalogue "Industrial Connectors Han <sup>®</sup> ")	

<sup>1)</sup> POF = Polymer Optical Fibre

## Features

- Electro-optic converters integrated in multi-mode connectors
- Up to 16 optical lines via one connection
- Cost-effective alternative to conventional connectors
- Suitable for 1 mm Ø polymer fibres ( $\lambda = 660\text{nm}$ )
- Transmission distance up to 60 m

## Technical characteristics

Standards	DIN EN 60 664-1 DIN EN 61 984
-----------	----------------------------------

### Approvals

### General and limiting values at T = 25 °C

#### Transmitter (LED): SFH 757

Wave-length	650 nm
Switching times	100 ns
Übertragungsrate	max. 100 Mbit/s
Output power (I = 10 mA)	
typ.	150 µW
min.	100 µW
Drive current	max. 50 mA
Forward voltage	2.1 V DC
Operating temperature	-40 °C ... +80 °C

#### Receiver (digital): SFH 551

Wave-length	600 nm ... 780 nm
Data rate	5 Mbit/s
Sensitivity	-22 dBm typ.
Optical input power	typ. 6 µW ... 1000 µW (at $\lambda = 650\text{ nm}$ )
Electrical output	TTL, open collector
Operating voltage	5 V DC $\pm 5\%$
Operating temperature	-40 °C ... +85 °C

#### Receiver (photo diode): SFH 250

Wave-length	400 nm ... 1100 nm
Switching times	10 ns
Photo current	3 µA (at $\lambda = 650\text{ nm}$ ; input power 10 µW; reverse voltage 5 V)
Dark current	1 nA typ. (at $V_R = 20\text{ V}$ )
Capacity	11 pF typ.
Operating temperature	-40 °C ... +85 °C

#### Receiver (photo diode): BPX 65

Wave-length	350 nm ... 1100 nm
Switching times	typ. 12 ns
Photo current	typ. 4 µA (at $\lambda = 650\text{ nm}$ ; input power 10 µW; reverse voltage 5 V)
Dark current	1 nA typ. (bei $V_R = 20\text{ V}$ )
Capacity	11 pF typ.
Operating temperature	-40 °C ... +85 °C





For short range data transmission with polymer optical fibres ( $\lambda = 660 \text{ nm}$ )  
 Multipole versions  
 for SFH 756, SFH 551 and SFH 250

Identification	Part Number	Drawing	Dimensions in mm
<p><b>Mounting device</b>  <b>16 cables</b></p> <p>for 1 mm POF<sup>1)</sup> fibres with HARTING POF ferrules</p>	<b>20 10 016 3211</b>		
<p><b>Mounting device</b>  <b>16 diodes</b></p> <p>solder straight                      with 8x SFH 757                      and 8x SFH 551</p>	<b>20 40 016 3823</b>		
<p><b>Mounting device</b>  <b>7 cables</b></p> <p>for 1 mm POF<sup>1)</sup> fibres with HARTING POF ferrules</p>	<b>20 10 007 3211</b>		
<p><b>Mounting device</b>  <b>7 diodes</b></p> <p>abgewinkelt                      with 3x SFH 757                      and 3x SFH 250</p>	<b>20 40 007 3821</b>		
<p>with 7x SFH 757</p>	<b>20 40 007 3841</b>		

<sup>1)</sup> POF = Polymer Optical Fibre



For short range data transmission with polymer optical fibres ( $\lambda = 660 \text{ nm}$ )  
 Multipole versions  
 for SFH 757, SFH 551 and SFH 250

Identification	Part Number	Drawing	Dimensions in mm
<p>Mounting device 3 cables</p> <p>for 1 mm POF<sup>1)</sup> fibres with HARTING POF ferrules</p> <p>20 10 003 3211</p>			
<p>Mounting device 3 diodes angled</p> <p>with 1x SFH 757 with 2x SFH 551</p> <p>20 40 003 3821</p> <p>with 2x SFH 757 with 1x SFH 551</p> <p>20 40 003 3822</p>			
<p>Ferrule</p> <p>1 mm POF<sup>1)</sup> with cladding gauge 2.2 mm</p> <p>20 10 001 3232</p>			<p>The mounting/endface-preparation of the ferrule can be achieved by crimping, hot-plate technique or by using adhesive</p>
		<p>The ferrules are snap-mounted into the male connector and can be released with aid of removal tool 09 99 000 0052 (see catalogue "Industrial Connectors Han®")</p>	



For short range data transmission with  
polymer optical fibres ( $\lambda = 660 \text{ nm}$ )  
Multipole versions  
for SFH 757 and SFH 551

Identification	Part Number	Drawing	Dimensions in mm
<b>Mounting device</b> <b>3 cables</b>  for 1 mm POF <sup>1)</sup>	<b>20 10 003 4811</b>		
<b>Mounting device</b> <b>3 diodes</b> angled with 2x SFH 757 with 1x SFH 551	<b>20 40 003 4813</b>		
with 1x SFH 757 with 2x SFH 551	<b>20 40 003 4823</b>		

<sup>1)</sup> POF = Polymer Optical Fibre

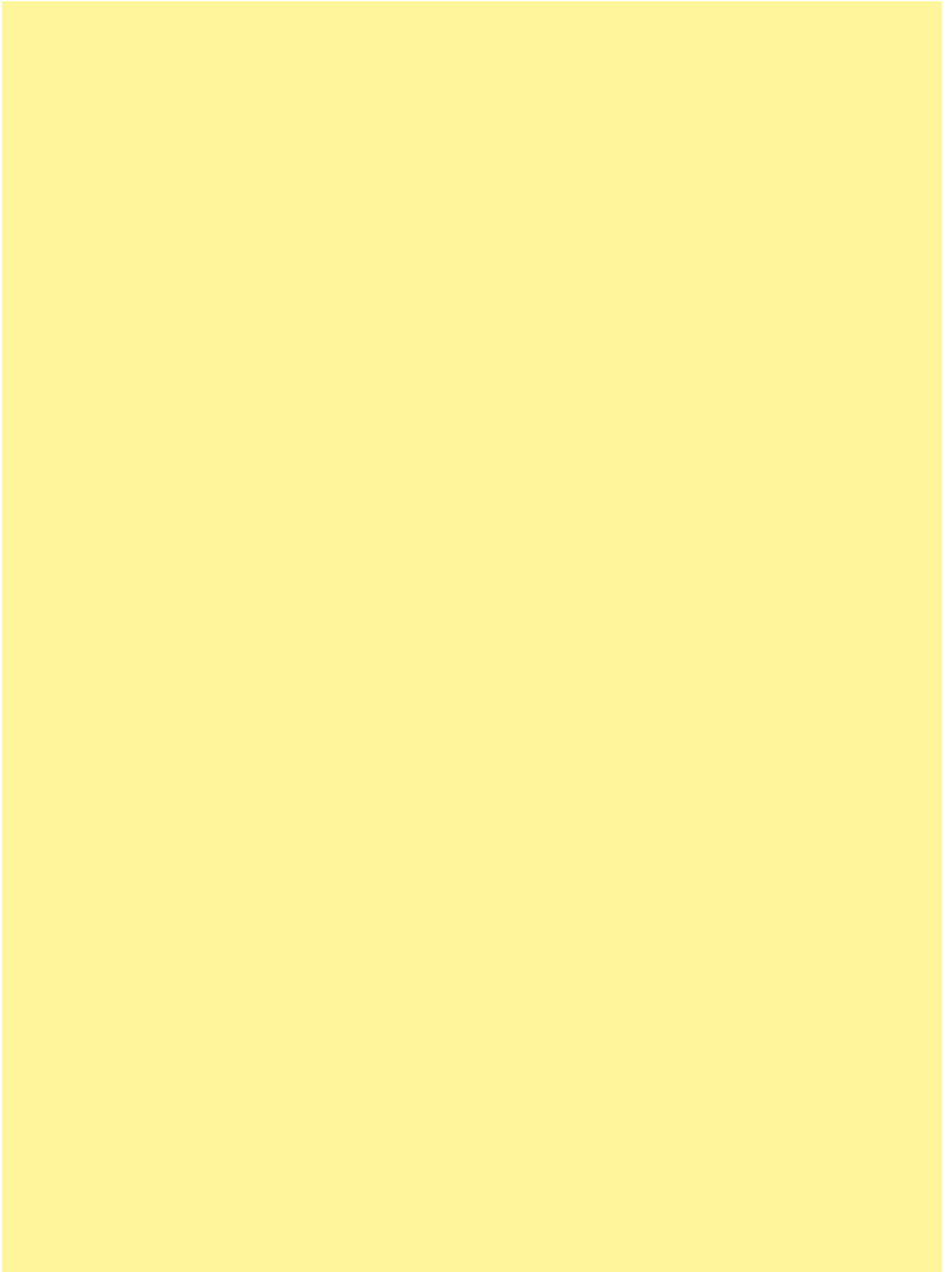





## Features

The standard hoods and housings can be equipped with a mix of FO contacts as well as contacts for other electrical applications

- FO contacts for 1 mm POF
- Suitable for industrial connectors Han for the series Han D®, Han DD®, Han E®, Han® EE, Han® K and Han-Modular®
- Mixed inserts using FO contacts and electrical contacts possible
- Combination of optical signals and electrical supply in one connector is possible
- Degree of protection IP 65, IP 67 or IP 68 in the locked position depending on the hoods and housings used

### Attention

Please make sure the correct contacts are used only in combination with the inserts given with the series mentioned above.

For more technical information and Part-Numbers concerning the inserts please refer to the catalogue "Industrial Connectors Han®".

## Technical characteristics

Standards	DIN EN 60 664-1 DIN EN 61 984
-----------	----------------------------------

### Inserts

see catalogue „Industrial Connectors Han®“	
Han D®	chapter 02
Han DD®	chapter 02
Han DD® module	chapter 06
Han® DDD module	chapter 06
Han E®	chapter 03
Han® EE	chapter 03
Han® K 8/24	chapter 05
Han® K 6/36	chapter 05
Han® K 12/2	chapter 05
Han® 4 A SC	chapter 19
Han® SC module	chapter 06
Han® Multi module	chapter 06





F.O. inserts for multi-pole connectors of serie Han DD<sup>®</sup>

Identification	Part number		Drawing	Dimensions in mm																					
	Male insert (M)	Female insert (F)																							
<b>Han<sup>®</sup> Inserts</b>																									
Han <sup>®</sup> 24 DD	09 16 024 3001	09 16 024 3101	<table border="1"> <thead> <tr> <th>Identification</th> <th>Size</th> <th>max. number of F.O. contacts</th> </tr> </thead> <tbody> <tr> <td>Han<sup>®</sup> 24 DD</td> <td>Han<sup>®</sup> 6 B</td> <td>24</td> </tr> <tr> <td>Han<sup>®</sup> 42 DD</td> <td>Han<sup>®</sup> 10 B</td> <td>42</td> </tr> <tr> <td>Han<sup>®</sup> 72 DD</td> <td>Han<sup>®</sup> 16 B</td> <td>72</td> </tr> <tr> <td>Han<sup>®</sup> 108 DD</td> <td>Han<sup>®</sup> 24 B</td> <td>108</td> </tr> <tr> <td>Han<sup>®</sup> 144 DD</td> <td>Han<sup>®</sup> 32 B</td> <td>144 (2x 72)</td> </tr> <tr> <td>Han<sup>®</sup> 216 DD</td> <td>Han<sup>®</sup> 48 B</td> <td>216 (2x 216)</td> </tr> </tbody> </table>	Identification	Size	max. number of F.O. contacts	Han <sup>®</sup> 24 DD	Han <sup>®</sup> 6 B	24	Han <sup>®</sup> 42 DD	Han <sup>®</sup> 10 B	42	Han <sup>®</sup> 72 DD	Han <sup>®</sup> 16 B	72	Han <sup>®</sup> 108 DD	Han <sup>®</sup> 24 B	108	Han <sup>®</sup> 144 DD	Han <sup>®</sup> 32 B	144 (2x 72)	Han <sup>®</sup> 216 DD	Han <sup>®</sup> 48 B	216 (2x 216)	
Identification	Size	max. number of F.O. contacts																							
Han <sup>®</sup> 24 DD	Han <sup>®</sup> 6 B	24																							
Han <sup>®</sup> 42 DD	Han <sup>®</sup> 10 B	42																							
Han <sup>®</sup> 72 DD	Han <sup>®</sup> 16 B	72																							
Han <sup>®</sup> 108 DD	Han <sup>®</sup> 24 B	108																							
Han <sup>®</sup> 144 DD	Han <sup>®</sup> 32 B	144 (2x 72)																							
Han <sup>®</sup> 216 DD	Han <sup>®</sup> 48 B	216 (2x 216)																							
Han <sup>®</sup> 42 DD	09 16 042 3001	09 16 042 3101																							
Han <sup>®</sup> 72 DD	09 16 072 3001	09 16 072 3101																							
Han <sup>®</sup> 108 DD	09 16 108 3001	09 16 108 3101																							
Han <sup>®</sup> 144 DD	09 16 072 3001	09 16 072 3101																							
	09 16 072 3011	09 16 072 3111																							
Han <sup>®</sup> 216 DD	09 16 108 3001	09 16 108 3101																							
	09 16 108 3011	09 16 108 3111																							
Han DD <sup>®</sup> Modul	09 14 012 3001	09 14 012 3101	<table border="1"> <thead> <tr> <th>Identification</th> <th>Size</th> <th>max. number of F.O. contacts</th> </tr> </thead> <tbody> <tr> <td>Han DD<sup>®</sup> Modul</td> <td>-</td> <td>12</td> </tr> <tr> <td>Han<sup>®</sup> DDD Modul</td> <td>-</td> <td>17</td> </tr> </tbody> </table>	Identification	Size	max. number of F.O. contacts	Han DD <sup>®</sup> Modul	-	12	Han <sup>®</sup> DDD Modul	-	17													
Identification	Size	max. number of F.O. contacts																							
Han DD <sup>®</sup> Modul	-	12																							
Han <sup>®</sup> DDD Modul	-	17																							
Han <sup>®</sup> DDDModul	09 14 017 3001	09 14 017 3101																							

Identification	Part number		Drawing	Dimensions in mm
	Male contact	Female contact		
<b>F.O. contacts for Han DD<sup>®</sup> contact cavity</b>				
for 1 mm POF <sup>1)</sup> fibre	20 10 001 3211	20 10 001 3221		

<sup>1)</sup> POF = Polymer Optical Fibre

F.O. inserts for multi-pole connectors of series Han E<sup>®</sup> and Han<sup>®</sup> EE

Identification	Part number		Drawing	Dimensions in mm																					
	Male insert (M)	Female insert (F)																							
<b>Han<sup>®</sup> Inserts</b>																									
Han <sup>®</sup> 6 E	09 33 006 2602	09 33 006 2702	<table border="1"> <thead> <tr> <th>Identification</th> <th>Size</th> <th>max. number of F.O. contacts</th> </tr> </thead> <tbody> <tr> <td>Han<sup>®</sup> 6 E</td> <td>Han<sup>®</sup> 6 B</td> <td>6</td> </tr> <tr> <td>Han<sup>®</sup> 10 E</td> <td>Han<sup>®</sup> 10 B</td> <td>10</td> </tr> <tr> <td>Han<sup>®</sup> 16 E</td> <td>Han<sup>®</sup> 16 B</td> <td>16</td> </tr> <tr> <td>Han<sup>®</sup> 24 E</td> <td>Han<sup>®</sup> 24 B</td> <td>24</td> </tr> <tr> <td>Han<sup>®</sup> 32 E</td> <td>Han<sup>®</sup> 32 B</td> <td>32 (2x 16)</td> </tr> <tr> <td>Han<sup>®</sup> 48 E</td> <td>Han<sup>®</sup> 48 B</td> <td>48 (2x 24)</td> </tr> </tbody> </table>	Identification	Size	max. number of F.O. contacts	Han <sup>®</sup> 6 E	Han <sup>®</sup> 6 B	6	Han <sup>®</sup> 10 E	Han <sup>®</sup> 10 B	10	Han <sup>®</sup> 16 E	Han <sup>®</sup> 16 B	16	Han <sup>®</sup> 24 E	Han <sup>®</sup> 24 B	24	Han <sup>®</sup> 32 E	Han <sup>®</sup> 32 B	32 (2x 16)	Han <sup>®</sup> 48 E	Han <sup>®</sup> 48 B	48 (2x 24)	
Identification	Size	max. number of F.O. contacts																							
Han <sup>®</sup> 6 E	Han <sup>®</sup> 6 B	6																							
Han <sup>®</sup> 10 E	Han <sup>®</sup> 10 B	10																							
Han <sup>®</sup> 16 E	Han <sup>®</sup> 16 B	16																							
Han <sup>®</sup> 24 E	Han <sup>®</sup> 24 B	24																							
Han <sup>®</sup> 32 E	Han <sup>®</sup> 32 B	32 (2x 16)																							
Han <sup>®</sup> 48 E	Han <sup>®</sup> 48 B	48 (2x 24)																							
Han <sup>®</sup> 10 E	09 33 010 2602	09 33 010 2702																							
Han <sup>®</sup> 16 E	09 33 016 2602	09 33 016 2702																							
Han <sup>®</sup> 24 E	09 33 024 2602	09 33 024 2702																							
Han <sup>®</sup> 32 E	09 33 016 2602	09 33 016 2702																							
	09 33 016 2612	09 33 016 2712																							
Han <sup>®</sup> 48 E	09 33 024 2602	09 33 024 2702																							
	09 33 024 2612	09 33 024 2712																							
<b>Han<sup>®</sup> EE Inserts</b>																									
Han <sup>®</sup> 10 EE	09 32 010 3001	09 32 010 3101	<table border="1"> <thead> <tr> <th>Identification</th> <th>Size</th> <th>max. number of F.O. contacts</th> </tr> </thead> <tbody> <tr> <td>Han<sup>®</sup> 10 EE</td> <td>Han<sup>®</sup> 6 B</td> <td>10</td> </tr> <tr> <td>Han<sup>®</sup> 18 EE</td> <td>Han<sup>®</sup> 10 B</td> <td>18</td> </tr> <tr> <td>Han<sup>®</sup> 32 EE</td> <td>Han<sup>®</sup> 16 B</td> <td>32</td> </tr> <tr> <td>Han<sup>®</sup> 46 EE</td> <td>Han<sup>®</sup> 24 B</td> <td>46</td> </tr> <tr> <td>Han<sup>®</sup> 64 EE</td> <td>Han<sup>®</sup> 32 B</td> <td>64 (2x 32)</td> </tr> <tr> <td>Han<sup>®</sup> 92 EE</td> <td>Han<sup>®</sup> 48 B</td> <td>92 (2x 46)</td> </tr> </tbody> </table>	Identification	Size	max. number of F.O. contacts	Han <sup>®</sup> 10 EE	Han <sup>®</sup> 6 B	10	Han <sup>®</sup> 18 EE	Han <sup>®</sup> 10 B	18	Han <sup>®</sup> 32 EE	Han <sup>®</sup> 16 B	32	Han <sup>®</sup> 46 EE	Han <sup>®</sup> 24 B	46	Han <sup>®</sup> 64 EE	Han <sup>®</sup> 32 B	64 (2x 32)	Han <sup>®</sup> 92 EE	Han <sup>®</sup> 48 B	92 (2x 46)	
Identification	Size	max. number of F.O. contacts																							
Han <sup>®</sup> 10 EE	Han <sup>®</sup> 6 B	10																							
Han <sup>®</sup> 18 EE	Han <sup>®</sup> 10 B	18																							
Han <sup>®</sup> 32 EE	Han <sup>®</sup> 16 B	32																							
Han <sup>®</sup> 46 EE	Han <sup>®</sup> 24 B	46																							
Han <sup>®</sup> 64 EE	Han <sup>®</sup> 32 B	64 (2x 32)																							
Han <sup>®</sup> 92 EE	Han <sup>®</sup> 48 B	92 (2x 46)																							
Han <sup>®</sup> 18 EE	09 32 018 3001	09 32 018 3101																							
Han <sup>®</sup> 32 EE	09 32 032 3001	09 32 032 3101																							
Han <sup>®</sup> 46 EE	09 32 046 3001	09 32 046 3101																							
Han <sup>®</sup> 64 EE	09 32 032 3001	09 32 032 3101																							
	09 32 032 3011	09 32 032 3111																							
Han <sup>®</sup> 92 EE	09 32 046 3001	09 32 046 3101																							
	09 32 046 3011	09 32 046 3111																							
<b>F.O. contacts for Han E<sup>®</sup> and Han<sup>®</sup> EE contact cavity</b>																									
for 1 mm POF <sup>1)</sup> fibre	20 10 001 3311	20 10 001 3321																							

<sup>1)</sup> POF = Polymer Optical Fibre



F.O. inserts for multi-pole connectors of serie Han® K

Identification	Part number		Drawing	Dimensions in mm												
	Male insert (M)	Female insert (F)														
<b>Han® Inserts</b>																
Han® K 8/24	09 38 032 3001	09 38 032 3101	<table border="1"> <thead> <tr> <th>Identification</th> <th>Size</th> <th>max. number of F.O. contacts</th> </tr> </thead> <tbody> <tr> <td>Han® K 8/24</td> <td>Han® 10 B</td> <td>24</td> </tr> <tr> <td>Han® K 6/36</td> <td>Han® 16 B</td> <td>36</td> </tr> <tr> <td>Han® K 12/2</td> <td>Han® 16 B</td> <td>2</td> </tr> </tbody> </table>	Identification	Size	max. number of F.O. contacts	Han® K 8/24	Han® 10 B	24	Han® K 6/36	Han® 16 B	36	Han® K 12/2	Han® 16 B	2	
Identification	Size	max. number of F.O. contacts														
Han® K 8/24	Han® 10 B	24														
Han® K 6/36	Han® 16 B	36														
Han® K 12/2	Han® 16 B	2														
Han® K 6/36	09 38 042 3001	09 38 042 3101														
Han® K 12/2	09 32 012 3001	09 32 012 3101														

Identification	Part number		Drawing	Dimensions in mm
	Male contact	Female contact		
<b>F.O. contacts for Han® K contact cavity</b>				
for 1 mm POF <sup>1)</sup> fibre	<b>20 10 001 3211</b>	<b>20 10 001 3221</b>		



F.O. inserts for multi-pole connectors of series Han® 4 A and Han-Modular®

Identification	Part number		Drawing	Dimensions in mm									
	Male insert (M)	Female insert (F)											
<b>Han® Inserts</b>													
Han® 4 A SC	09 20 004 4701	09 20 004 4711	<table border="1"> <thead> <tr> <th>Identification</th> <th>Size</th> <th>max. number of F.O. contacts</th> </tr> </thead> <tbody> <tr> <td>Han® 4 A SC</td> <td>Han® 3 A</td> <td>4</td> </tr> <tr> <td>Han® SC module</td> <td>-</td> <td>4</td> </tr> </tbody> </table>	Identification	Size	max. number of F.O. contacts	Han® 4 A SC	Han® 3 A	4	Han® SC module	-	4	
Identification	Size	max. number of F.O. contacts											
Han® 4 A SC	Han® 3 A	4											
Han® SC module	-	4											
Han® SC module	09 14 004 4701	09 14 004 4711											

Identification	Part number		Drawing	Dimensions in mm
	Male contact	Female contact		
<b>SC contacts</b>				
for GI fibre 50/125 µm or 62.5/125 µm ceramic ferrule	<b>20 10 125 5211</b>			
for SI fibre (HCS® 1) 200/230 µm	<b>20 10 230 5211</b>			
for 1 mm POF <sup>2)</sup> fibre with IDC termination technology	<b>20 10 001 5217</b>			
Crimp contact for 1 mm POF <sup>2)</sup> fibre (for Han® SC module only)	<b>20 10 001 5211</b>			

1) HCS® Hard Clad Silica (is registered trade mark of the SpecTran Corporation)  
2) POF = Polymer Optical Fibre



F.O. inserts for multi-pole connectors of serie Han-Modular®

Identification	Part number		Drawing	Dimensions in mm									
	Male insert (M)	Female insert (F)											
<b>Han® Inserts</b>													
Han® Multi module 4 contacts	09 14 004 4501	09 14 004 4512	<table border="1"> <thead> <tr> <th>Identification</th> <th>Size</th> <th>max. number of F.O. contacts</th> </tr> </thead> <tbody> <tr> <td>Han® Multi module</td> <td>-</td> <td>4</td> </tr> <tr> <td>Han® Multi module</td> <td>-</td> <td>12</td> </tr> </tbody> </table>	Identification	Size	max. number of F.O. contacts	Han® Multi module	-	4	Han® Multi module	-	12	
Identification	Size	max. number of F.O. contacts											
Han® Multi module	-	4											
Han® Multi module	-	12											
12 contacts	09 14 012 4501	09 14 012 4512											
Other fields of application see also catalogue „Connectors DIN 41 612“													

Identification	Part number		Drawing	Dimensions in mm
	Male contact	Female contact		
<b>F.O. contacts according to DIN 41 626</b>				
for GI fibre 50/125 µm or 62.5/125 µm ceramic ferrule	20 10 125 4212	20 10 125 4222		
for SI fibre (HCS® 1) 200/230 µm	20 10 230 4211	20 10 230 4221		
for 1 mm POF fibre	20 10 001 4211	20 10 001 4221		
with LED 650 nm	20 10 001 4231			
with receiver 5 Mbit/s	20 10 001 4232			

1) HCS® Hard Clad Silica (is registered trade mark of the SpecTran Corporation)

CONTENTS	PAGE
Han® 4 A SC	32
Han-Brid® Features	34
Han-Brid® F.O.	35
Description of the Han-Modular® system	37
Han DD® module	38
Han® DDD module	40
Han® Multi module 4 contacts according to DIN 41 626	42
Han® Multi module 12 contacts according to DIN 41 626	44
Han® SC module	46



### Features

- Suitable with housings, size Han® 3 A including versions Han® M, Han® EMV and Han® HPR
- Degree of protection up to IP 68
- For fibre optic SC contacts; up to 4 SC contacts per connector
- For Multimode fibre 50 - 62.5 / 125 µm and Single-mode fibre 9 / 125 µm
- Full ceramic sleeves for a minimal insertion loss

## Assembly instructions

### Male insert (09 20 004 4701)

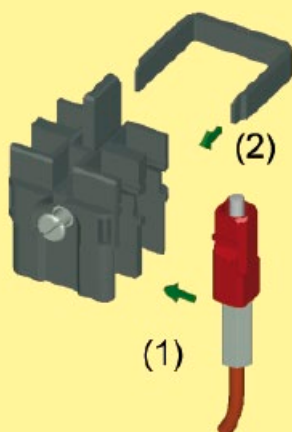

#### Assemble the SC contact

- (1) Push the SC contact from the side into the relevant insert
- (2) Push the spring clip over the contact body.

### Female insert (09 20 004 4711)

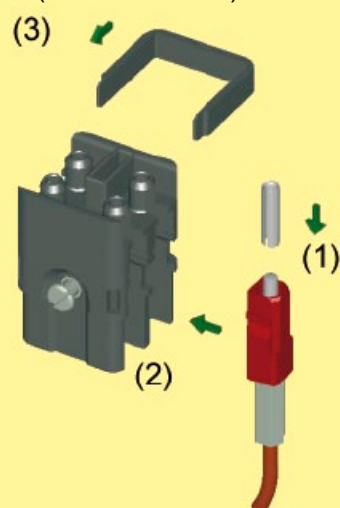

#### Assemble the SC contact

- (1) Push the centering ferrule (included in delivery) on the SC contact
- (2) Push the SC contact from the side into the relevant insert
- (3) Push the spring clip over the contact body.

Number of contacts

4

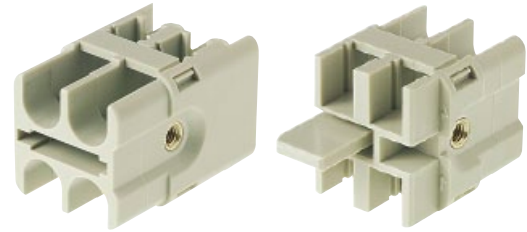

Identification	Part number		Drawing	Dimensions in mm
	Male insert (M)	Female insert (F)		
SC module Order SC contacts separately	<b>09 20 004 4701</b>	<b>09 20 004 4711</b>		Contact arrangement view from termination side  The female inserts are equipped with centering ferrules. 4 ferrules are included in delivery range.

Identification	Part number		Drawing	Dimensions in mm
	Male contact	Female contact		
SC contact for GI fibre 50/125 µm or 62.5/125 µm ceramic ferrule  	<b>20 10 125 5211</b>	<b>20 10 125 5211</b>		
for SI fibre (HCS® <sup>1)</sup> ) 200/230 µm	<b>20 10 230 5211</b>	<b>20 10 230 5211</b>		
with quick assembly technique for 1 mm POF <sup>2)</sup>	<b>20 10 001 5217</b>	<b>20 10 001 5217</b>		
with crimp termination technique for 1 mm POF <sup>2)</sup>	<b>20 10 001 5211</b>	<b>20 10 001 5211</b>		

<sup>1)</sup> HCS®=Hard Clad Silica is registered trade mark of SpecTran Corporation  
<sup>2)</sup> POF = Polymer Optical Fibre

## Features

### General Description

The Han-Brid® series allows the connection of a data interface and a power supply in a single space saving connector. This means that it is now possible to provide data transmission and power to devices in a single bus structure. This hybrid connector family includes provision for connection of a max. 50 V, 10 A power supply together with a range of inserts for connection of a variety of data protocols and transmission medias:

- Han-Brid® F.O. for plastic (POF) or for HCS®\* optical fibre
- Han-Brid® Cu for shielded twisted pair.
- Han-Brid® Quintax 3 A for shielded 4 wire bus systems (2 pair STP)
- Han-Brid® RJ45 C for Ethernet application
- Han-Brid® USB / Firewire for fast data transmission

Han-Brid® inserts fit into the standard plastic as well as metal hoods and housings with seal of the Han® 3 A series offering a degree of protection IP 65 according to DIN EN 60 529. For harsher environments Han® 3 HPR hoods and housings with a degree of protection of IP 68 can be used.

## Power supply

- Han D® male and female with standard crimp contacts
- Rated current 10 A
- Rated voltage 50 V
- termination side 0.14 - 2.5 mm<sup>2</sup>
- Approval

## Data interfaces

### Han-Brid® F.O.

- Is suitable for all HP Versatile Link (Horizontal Package) transmitters and receivers
- Data rates: Standard 12 Mbit/s, suitable for all common fieldbus systems
- Insert allows integration of HP standard contacts for POF<sup>2)</sup> and HCS®<sup>1)</sup> fibres
- Temperature range: -40 °C ... +70 °C

## Wiring plan

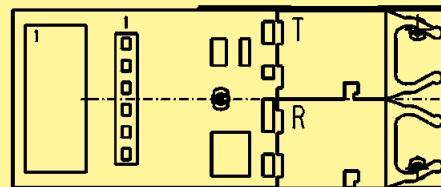

### Signal assignment:

- /R Optical reception data (electrical output), TTL-compatible, negative logic,  $I_{out\ max}: \pm 16\ mA$
- GND Ground, Power supply, data
- +5VDC Power supply +5 V DC  $\pm 5\ %$
- /T Optical transmission data (electrical input), TTL compatible, negative logic





### Optical elements:

Laser classification I



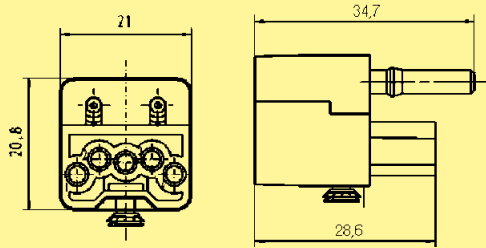

	Pin Out			
	/R	GND	-5VDC	/T
Board stacker	5	4, 6	1, 3	2
IDC	8, 9	1, 4, 7, 10	2, 3	5, 6

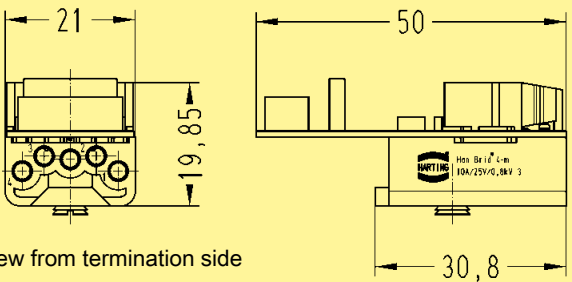
Hybrid field bus connector  
with F.O. transmitter and receiver  
+ 4 electrical contacts 10 A  
+ option for PE

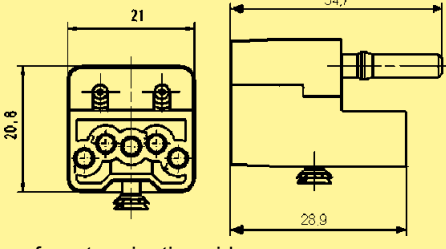

Identification	Part number		Drawing	Dimensions in mm
	Male insert (M)	Female insert (F)		
<p>Cable side, female F.O. (m) + Han D® (f)</p> <p>with F.O. contacts</p>  <p>without F.O. contacts</p> 		<p>for POF 09 12 004 2711</p> <p>for POF crimpless 09 12 004 2713</p> <p>for HCS®* fibre 09 12 004 2716</p> <p>for POF 09 12 004 3111</p> <p>for POF crimpless 09 12 004 3113</p> <p>for HCS®* fibre 09 12 004 3116</p>	 <p>view from termination side</p>	
<p>Device side, male F.O. (f) + Han D® (m)</p> <p>with PCB</p>  <p>without PCB</p> 	<p>09 12 004 2611</p> <p>09 12 004 3011</p>		 <p>view from termination side</p>	

\* HCS®=Hard Clad Silica (is registered trade mark of the SpecTran Corporation)

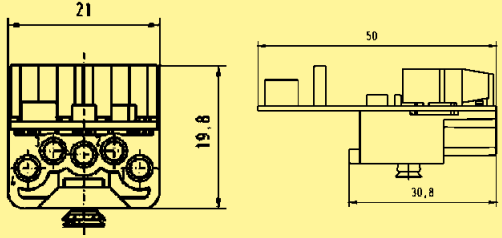
Identification	Part number		Drawing	Dimensions in mm
	Male insert (M)	Female insert (F)		
<p><b>Cable side, male</b> F.O. (m) + Han D® (m)</p> <p>with F.O. contact</p>  <p>without F.O. contact</p> 	<p>for POF <b>09 12 004 2601</b></p> <p>for POF crimpless <b>09 12 004 2603</b></p> <p>for HCS®* fibre 09 12 004 2606</p>		 <p>view from termination side</p>	
<p><b>Device side, female</b> F.O. (f) + Han D® (f)</p> <p>with PCB</p>  <p>without PCB</p> 		<p>09 12 004 2701</p> <p>09 12 004 3101</p>	 <p>view from termination side</p>	

## Description of the Han-Modular® system

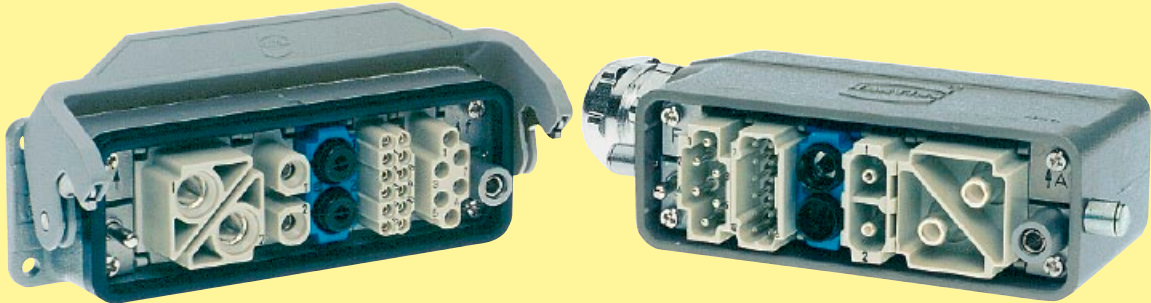

The Han-Modular® series is a new system of inserts designed to meet the specific requirements of individual customers. In close cooperation with potential users a range of modular inserts have been developed allowing the simple assembly of custom designed complete connectors which meet the diverse requirements encountered by designers today.

Han-Modular® is a logical development of the Han-Com® series which already offers the combination of power and signal circuits in one connector.

The individual modules of this series now allow the integration of electrical, optical and gaseous signal and power connections in one connector assembly.

The pneumatic contacts are also suitable for the connection of liquid media. However it must be stated that a combination of electrical and liquid connections in one connector is not allowed according to VDE regulations.

The individual contacts used in this system are all from existing well proven ranges and it is possible to use combinations of 1 to 12 modules depending on the size of the hoods and housings chosen.

The basic modules snap into a mounting frame and can be exchanged separately at any time.

### Advantages:

- Custom designs can be simply assembled
- Optimum solutions can be reached
- Stock can be minimized

### Assembly details

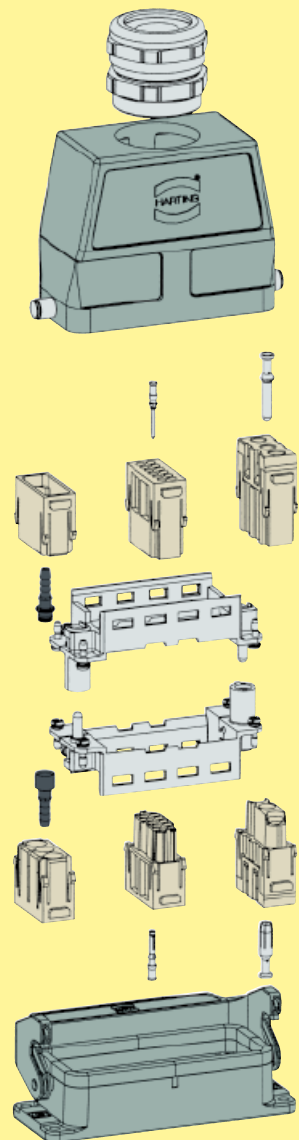



Number of contacts

12

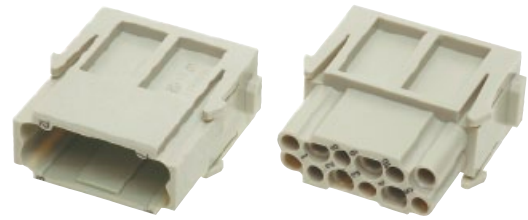

Identification	Part number		Drawing	Dimensions in mm
	Male insert (M)	Female insert (F)		
Crimp terminal Order crimp contacts separately	<b>09 14 012 3001</b>	<b>09 14 012 3101</b>	<p style="text-align: center;">Contact arrangement view from termination side</p>	

Identification	Wire gauge (mm <sup>2</sup> )	Part number		Drawing	Dimensions in mm
		Male contact	Female contact		
F.O. contacts for 1 mm plastic fibre		<b>20 10 001 3211</b>	<b>20 10 001 3221</b>		





Number of contacts

17

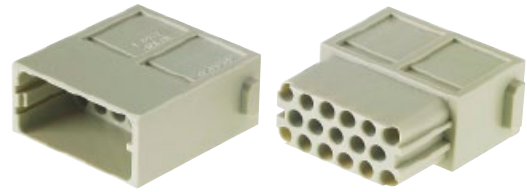

Identification	Part number		Drawing	Dimensions in mm
	Male insert (M)	Female insert (F)		
Crimp terminal Order crimp contacts separately	<b>09 14 017 3001</b>	<b>09 14 017 3101</b>	<p>M</p> <p>F</p> <p>M F</p> <p>Contact arrangement view from termination side</p>	

Identification	Wire gauge (mm <sup>2</sup> )	Part number		Drawing	Dimensions in mm
		Male contact	Female contact		
F.O. contacts for 1 mm plastic fibre		<b>20 10 001 3211</b>	<b>20 10 001 3221</b>	<p>M</p> <p>F</p>	



Number of contacts

# 4

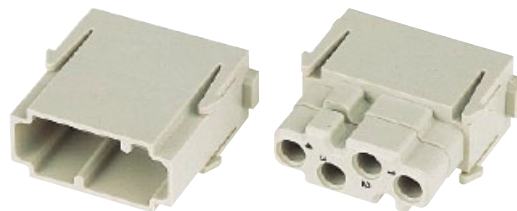

Identification	Part number		Drawing	Dimensions in mm
	Male insert (M)	Female insert (F)		
Multi module acc. to DIN 41 626 Order contacts separately	<b>09 14 004 4501</b>	<b>09 14 004 4512</b>		<p>Contact arrangement view from termination side</p>

Identification	Impedance	Part number		Drawing	Dimensions in mm
F.O. contacts acc. to DIN 41 626 for SI fibre (HCS® 1) 200/230 µm		20 10 230 4211	<b>20 10 230 4221</b>		
for GI fibre 50/125 µm or 62.5/125 µm ceramic ferrule		20 10 125 4212	<b>20 10 125 4222</b>		
for 1 mm plastic fibre		20 10 001 4211	<b>20 10 001 4221</b>		
with LED 650 nm		20 10 001 4231			
with receiver 5 Mbit/s		20 10 001 4232			

\* HCS®=Hard Clad Silica (is registered trade mark of the SpecTran Corporation)



Number of contacts

# 12



Identification	Part number		Drawing	Dimensions in mm
	Male insert (M)	Female insert (F)		
Multi module acc. to DIN 41 626 Order contacts separately	<b>09 14 012 4501</b>	<b>09 14 012 4512</b>	<p>Contact arrangement view from termination side</p>	

Identification	Impedance	Part number		Drawing	Dimensions in mm
F.O. contacts acc. to DIN 41 626 for SI fibre (HCS®) 200/230 µm		20 10 230 4211	20 10 230 4221		
for GI fibre 50/125 µm or 62.5/125 µm ceramic ferrule		20 10 125 4212	20 10 125 4222		
for 1 mm plastic fibre		20 10 001 4211	20 10 001 4221		
with LED 650 nm		20 10 001 4231			
with receiver 5 Mbit/s		20 10 001 4232			

\* HCS®=Hard Clad Silica (is registered trade mark of the SpecTran Corporation)

## Features

- Suitable for SC contacts
- For GI-Fibre 50 - 62.5 / 125µm
- Using of guiding pins (male and female) is recommended (see chapter 40).

## Technical characteristics

### Inserts

Number of contacts	4
Insertion loss	< 0.5 dB
Material	polycarbonate
Limiting temperatures	-40 °C ... +85 °C
Flammability acc. to UL 94	V 0
Mechanical working life	≥ 500
- mating cycles	

## Assembly instructions

### Male insert (09 14 004 4701)

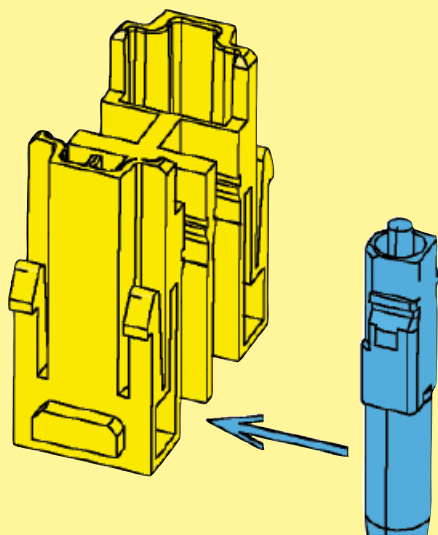

Assemble the SC contact

Push the SC contact from the side into the relevant insert

### Female insert (09 14 004 4711)

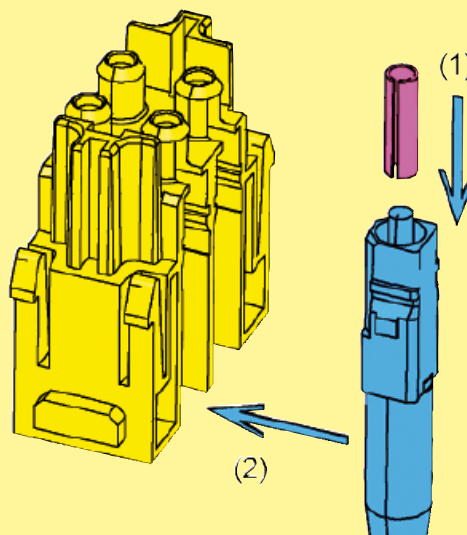

Assemble the SC contact

Push the centering ferrule (included in delivery) on the SC contact

Push the SC contact from the side into the relevant insert

Number of contacts

# 4

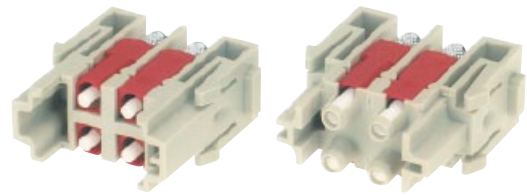

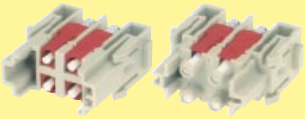
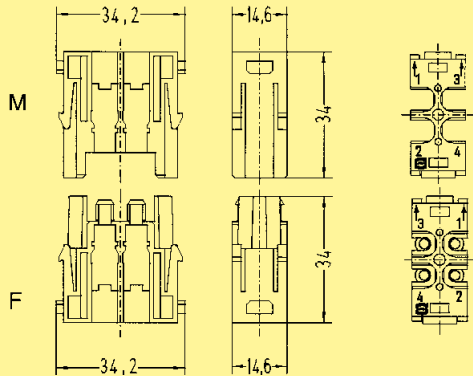
Identification	Part number		Drawing	Dimensions in mm
	Male insert (M)	Female insert (F)		
SC module Order contacts separately 	<b>09 14 004 4701</b>	<b>09 14 004 4711*</b>	 <p style="text-align: center;">Contact arrangement view from termination side</p>	

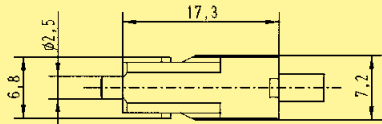
Identification	Part number		Drawing	Dimensions in mm
	Male contact	Female contact		
SC contact  for GI fibre 50/125 µm or 62.5/125 µm ceramic ferrule 		<b>20 10 125 5211</b>		
for SI fibre (HCS®) 200/230 µm		<b>20 10 230 5211</b>		
with quick assembly technique for 1 mm POF <sup>2)</sup>		<b>20 10 001 5217</b>		
Crimp contacts for 1 mm POF <sup>2)</sup>		<b>20 10 001 5211</b>		

\* The female inserts are equipped with centering ferrules. 4 ferrules are included in delivery range.

<sup>1)</sup> HCS®=Hard Clad Silica (is registered trade mark of the SpecTran Corporation)

<sup>1)</sup> POF=Polymer Optical Fibre



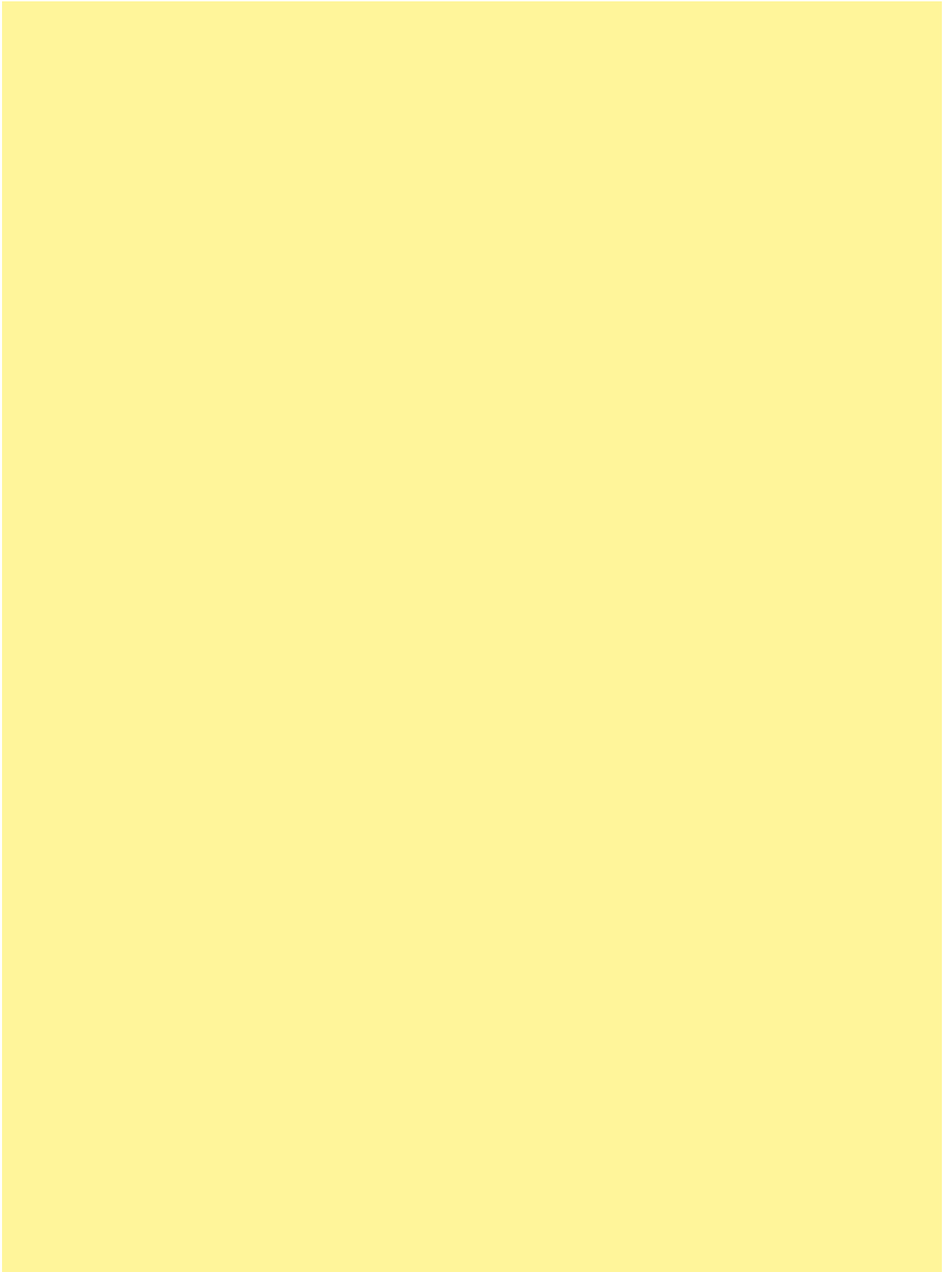

CONTENTS	PAGE
<b>Cable Assemblies</b>	
HARTING PushPull	50
Han® SFP	56
Han® PushPull SCRJ	58
Han® 3 A	59
Han® 3 A Hybrid	61
<b>F.O. and Hybrid connectors</b>	
HARTING PushPull LC duplex	63
Han® PushPull SCRJ	66
Han® 3 A LC duplex	71



Identification	Part No.	Drawing	Dimensions in mm
<p>Fibre optic cable, double ended, single mode</p> <p>Length: a = 1 m</p> <p>a = 5 m</p> <p>a = 10 m</p> <p>a = 20 m</p> <p>a = 40 m</p> <p>a = 50 m</p> <p>a = 100 m</p>	<p>33 58 211 0010 002</p> <p>33 58 211 0050 002</p> <p>33 58 211 0100 002</p> <p>33 58 211 0200 002</p> <p>33 58 211 0400 002</p> <p>33 58 211 0500 002</p> <p>33 58 211 1000 002</p>	<p>double ended</p> <p>a = length</p>	
<p>Fibre optic cable, single ended, single mode</p> <p>Length: a = 1 m</p> <p>a = 5 m</p> <p>a = 10 m</p> <p>a = 20 m</p> <p>a = 40 m</p> <p>a = 50 m</p> <p>a = 100 m</p>	<p>33 58 111 0010 002</p> <p>33 58 111 0050 002</p> <p>33 58 111 0100 002</p> <p>33 58 111 0200 002</p> <p>33 58 111 0400 002</p> <p>33 58 111 0500 002</p> <p>33 58 111 1000 002</p>	<p>Protection level: IP 65 / IP 67</p> <p>single ended</p> <p>a = length</p>	
<p>Fibre optic breakout cable, single mode</p> <p>Length: 10 m</p> <p>Length: 20 m</p> <p>Length: 100 m</p>	<p>33 58 751 0100 002</p> <p>33 58 751 0200 002</p> <p>33 58 751 1000 002</p>	<p>PUR jacket</p> <p>2-fibre single mode</p> <p>Outer diameter: 6.5 mm</p> <p>Min. bending radius: 10.4 cm</p> <p>Installation: 10.4 cm</p> <p>Operating: 5.2 cm</p>	



Identification	Part No.	Drawing	Dimensions in mm
<p>Fibre optic cable, double ended, single mode overmolded</p> <p>Length: a = 1 m</p> <p>a = 5 m</p> <p>a = 10 m</p> <p>a = 20 m</p> <p>a = 40 m</p> <p>a = 50 m</p> <p>a = 60 m</p> <p>a = 100 m</p> <p>a = 300 m</p>	<p>33 58 231 0010 015</p> <p>33 58 231 0050 015</p> <p>33 58 231 0100 015</p> <p>33 58 231 0200 015</p> <p>33 58 231 0400 015</p> <p>33 58 231 0500 015</p> <p>33 58 231 0600 015</p> <p>33 58 231 1000 015</p> <p>33 58 231 3000 015</p>	<p>double ended</p> <p>a = length</p>	
<p>Fibre optic breakout cable, single mode</p> <p>Length: 10 m</p> <p>Length: 20 m</p> <p>Length: 100 m</p>	<p>33 58 751 0100 002</p> <p>33 58 751 0200 002</p> <p>33 58 751 1000 002</p>	<p>PUR jacket</p> <p>2-fibre single mode</p> <p>Outer diameter: 6.5 mm</p> <p>Min. bending radius: 10.4 cm</p> <p>Installation: 5.2 cm</p> <p>Operating: 5.2 cm</p>	

Further cable lengths are available on request



Identification	Part No.	Drawing	Dimensions in mm
<p>Fibre optic cable, double ended, multi mode, 50 <math>\mu</math>m</p> <p>Length: a = 1 m</p> <p>a = 5 m</p> <p>a = 10 m</p> <p>a = 20 m</p> <p>a = 40 m</p> <p>a = 50 m</p> <p>a = 100 m</p>	<p>33 58 211 0010 004</p> <p>33 58 211 0050 004</p> <p>33 58 211 0100 004</p> <p>33 58 211 0200 004</p> <p>33 58 211 0400 004</p> <p>33 58 211 0500 004</p> <p>33 58 211 1000 004</p>	<p>double ended</p> <p>a = length</p>	
<p>Fibre optic cable, single ended, multi mode, 50 <math>\mu</math>m</p> <p>Length: a = 1 m</p> <p>a = 5 m</p> <p>a = 10 m</p> <p>a = 20 m</p> <p>a = 40 m</p> <p>a = 50 m</p> <p>a = 100 m</p>	<p>33 58 111 0010 004</p> <p>33 58 111 0050 004</p> <p>33 58 111 0100 004</p> <p>33 58 111 0200 004</p> <p>33 58 111 0400 004</p> <p>33 58 111 0500 004</p> <p>33 58 111 1000 004</p>	<p>Protection level: IP 65 / IP 67</p> <p>single ended</p> <p>a = length</p>	
<p>Fibre optic breakout cable, multi mode, 50 <math>\mu</math>m</p> <p>Length: 10 m</p> <p>Length: 20 m</p> <p>Length: 100 m</p>	<p>33 58 751 0100 003</p> <p>33 58 751 0200 003</p> <p>33 58 751 1000 003</p>	<p>PUR jacket</p> <p>2-fibre multi mode 50 <math>\mu</math>m</p> <p>Outer diameter: 6.5 mm</p> <p>Min. bending radius:</p> <p>Installation: 10.4 cm</p> <p>Operating: 5.2 cm</p>	



Identification	Part No.	Drawing	Dimensions in mm
<p>Fibre optic cable, double ended, multi mode, 50 µm overmolded</p> <p>Length: a = 1 m</p> <p>a = 5 m</p> <p>a = 10 m</p> <p>a = 20 m</p> <p>a = 40 m</p> <p>a = 50 m</p> <p>a = 60 m</p> <p>a = 100 m</p> <p>a = 300 m</p>	<p>33 58 231 0010 017</p> <p>33 58 231 0050 017</p> <p>33 58 231 0100 017</p> <p>33 58 231 0200 017</p> <p>33 58 231 0400 017</p> <p>33 58 231 0500 017</p> <p>33 58 231 0600 017</p> <p>33 58 231 1000 017</p> <p>33 58 231 3000 017</p>	<p>double ended</p> <p>a = length</p>	
<p>Fibre optic breakout cable, multi mode</p> <p>Length: 10 m</p> <p>Length: 20 m</p> <p>Length: 100 m</p>	<p>33 58 751 0100 003</p> <p>33 58 751 0200 003</p> <p>33 58 751 1000 003</p>	<p>PUR jacket</p> <p>2-fibre multi mode 50 µm</p> <p>Outer diameter: 6.5 mm</p> <p>Min. bending radius:</p> <p>Installation: 10.4 cm</p> <p>Operating: 5.2 cm</p>	

Further cable lengths are available on request



Identification	Part No.	Drawing	Dimensions in mm
<p>Fibre optic cable, double ended, multi mode, 62.5 <math>\mu</math>m</p> <p>Length: a = 1 m</p> <p>a = 5 m</p> <p>a = 10 m</p> <p>a = 20 m</p> <p>a = 40 m</p> <p>a = 50 m</p> <p>a = 100 m</p>	<p>33 58 211 0010 001</p> <p>33 58 211 0050 001</p> <p>33 58 211 0100 001</p> <p>33 58 211 0200 001</p> <p>33 58 211 0400 001</p> <p>33 58 211 0500 001</p> <p>33 58 211 1000 001</p>	<p>double ended</p> <p>a = length</p>	
<p>Fibre optic cable, single ended, multi mode, 62.5 <math>\mu</math>m</p> <p>Length: a = 1 m</p> <p>a = 5 m</p> <p>a = 10 m</p> <p>a = 20 m</p> <p>a = 40 m</p> <p>a = 50 m</p> <p>a = 100 m</p>	<p>33 58 111 0010 001</p> <p>33 58 111 0050 001</p> <p>33 58 111 0100 001</p> <p>33 58 111 0200 001</p> <p>33 58 111 0400 001</p> <p>33 58 111 0500 001</p> <p>33 58 111 1000 001</p>	<p>Protection level: IP 65 / IP 67</p> <p>single ended</p> <p>a = length</p>	
<p>Fibre optic breakout cable, multi mode, 62.5 <math>\mu</math>m</p> <p>Length: 10 m</p> <p>Length: 20 m</p> <p>Length: 100 m</p>	<p>33 58 751 0100 001</p> <p>33 58 751 0200 001</p> <p>33 58 751 1000 001</p>		<p>PUR jacket</p> <p>2-fibre multi mode 62.5 <math>\mu</math>m</p> <p>Outer diameter: 7 mm</p> <p>Min. bending radius: 10.5 cm</p> <p>Installation: 10.5 cm</p> <p>Operating: 7.0 cm</p>



Identification	Part No.	Drawing	Dimensions in mm
<p>Fibre optic cable, double ended, multi mode, 62.5 <math>\mu\text{m}</math> overmolded</p> <p>Length: a = 1 m</p> <p>a = 5 m</p> <p>a = 10 m</p> <p>a = 20 m</p> <p>a = 40 m</p> <p>a = 50 m</p> <p>a = 60 m</p> <p>a = 100 m</p> <p>a = 300 m</p>	<p>33 58 231 0010 016</p> <p>33 58 231 0050 016</p> <p>33 58 231 0100 016</p> <p>33 58 231 0200 016</p> <p>33 58 231 0400 016</p> <p>33 58 231 0500 016</p> <p>33 58 231 0600 016</p> <p>33 58 231 1000 016</p> <p>33 58 231 3000 016</p>	<p>double ended</p> <p>a = length</p>	
<p>Fibre optic breakout cable, multi mode, 62.5 <math>\mu\text{m}</math></p> <p>Length: 10 m</p> <p>Length: 20 m</p> <p>Length: 100 m</p>	<p>33 58 751 0100 001</p> <p>33 58 751 0200 001</p> <p>33 58 751 1000 001</p>	<p>PUR jacket</p> <p>2-fibre multi mode 62.5 <math>\mu\text{m}</math></p> <p>Outer diameter: 7 mm</p> <p>Min. bending radius:</p> <p>Installation: 10.5 cm</p> <p>Operating: 7.0 cm</p>	

Further cable lengths are available on request





Identification	Part No.	Drawing	Dimensions in mm
<p>Fibre optic cable, double ended, single mode Han® SFP LC duplex to LC duplex</p> <p>Length: a = 1.0 m</p> <p>a = 2.0 m</p> <p>a = 5.0 m</p> <p>a = 10.0 m</p> <p>a = 15.0 m</p> <p>a = 20.0 m</p>	<p>33 54 451 0010 010</p> <p>33 54 451 0020 010</p> <p>33 54 451 0050 010</p> <p>33 54 451 0100 010</p> <p>33 54 451 0150 010</p> <p>33 54 451 0200 010</p>	<p>double ended</p> <p>a = length</p>	
<p>Fibre optic cable, double ended, multi mode 50/125 µm Han® SFP LC duplex to LC duplex</p> <p>Length: a = 1.0 m</p> <p>a = 2.0 m</p> <p>a = 5.0 m</p> <p>a = 10.0 m</p> <p>a = 15.0 m</p> <p>a = 20.0 m</p>	<p>33 54 451 0010 012</p> <p>33 54 451 0020 012</p> <p>33 54 451 0050 012</p> <p>33 54 451 0100 012</p> <p>33 54 451 0150 012</p> <p>33 54 451 0200 012</p>		
<p>Fibre optic cable, double ended, multi mode 62.5/125 µm Han® SFP LC duplex to LC duplex</p> <p>Length: a = 1.0 m</p> <p>a = 2.0 m</p> <p>a = 5.0 m</p> <p>a = 10.0 m</p> <p>a = 15.0 m</p> <p>a = 20.0 m</p>	<p>33 54 451 0010 007</p> <p>33 54 451 0020 007</p> <p>33 54 451 0050 007</p> <p>33 54 451 0100 007</p> <p>33 54 451 0150 007</p> <p>33 54 451 0200 007</p>		



### Advantages

- For blind mating on various optical SFP transceivers
- Direct compensation of largest transceiver tolerances
- Direct connection to SFP transceivers
- Mechanical keying – no mismatching possible

### Technical characteristics

Degree of protection	IP 65 / IP 67
Mating face	LC acc. to IEC 61 754-20
Mating cycles	50
Temperature range	-40 °C ... +85 °C
Housing material	Zinc die-cast, powder coating black
Glas optical fibre	Single mode, multi mode 50/125 and multi mode 62.5/125

Identification

Part No.

Drawing

Dimensions in mm

Han® SFP

Receptacle housing device side

09 57 474 0500 001

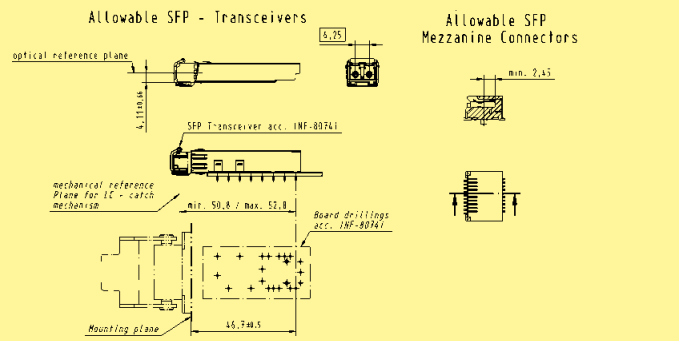

Wandausschnitt und Befestigungsbohrungen  
Panel Cutout and drillings

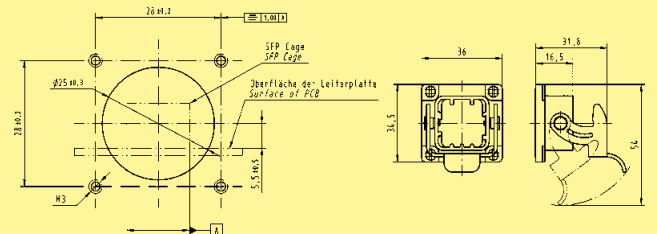

Assembly aid

09 57 000 0000 200

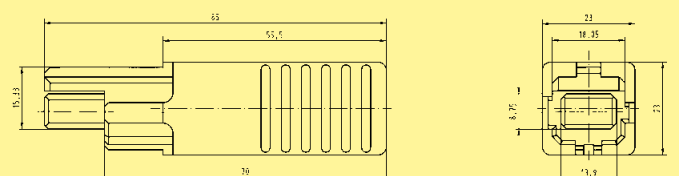



Identification	Part No.	Drawing	Dimensions in mm
<b>Han® PushPull SCRJ</b> double ended Hood: plastic with top entry Cable: POF, multi mode, 980/1000 μm, PROFINET type C Length: a = 1 m a = 2 m a = 5 m a = 10 m a = 20 m	33 53 211 0010 001 33 53 211 0020 001 33 53 211 0050 001 33 53 211 0100 001 33 53 211 0200 001		
<b>Han® PushPull SCRJ</b> double ended Hood: metal with top entry Cable: POF, multi mode, 980/1000 μm, PROFINET type C Length: a = 1 m a = 2 m a = 5 m a = 10 m a = 20 m	33 53 211 0010 002 33 53 211 0020 002 33 53 211 0050 002 33 53 211 0100 002 33 53 211 0200 002		
<b>Han® PushPull SCRJ</b> single ended Hood: plastic with top entry Cable: POF, multi mode, 980/1000 μm, PROFINET type C Length: a = 1 m a = 2 m a = 5 m a = 10 m a = 20 m	33 53 111 0010 001 33 53 111 0020 001 33 53 111 0050 001 33 53 111 0100 001 33 53 111 0200 001		
<b>Han® PushPull SCRJ</b> single ended Hood: metal with top entry Cable: POF, multi mode, 980/1000 μm, PROFINET type C Length: a = 1 m a = 2 m a = 5 m a = 10 m a = 20 m	33 53 111 0010 002 33 53 111 0020 002 33 53 111 0050 002 33 53 111 0100 002 33 53 111 0200 002		



Identification	Part No.	Drawing	Dimensions in mm
<b>Fibre optic cable, double ended, single mode, metal</b> 2 x Han® 3 A, 2 x LC duplex  Length: a = 1 m a = 5 m a = 10 m a = 20 m a = 40 m a = 50 m a = 100 m	33 54 211 0010 001 33 54 211 0050 001 33 54 211 0100 001 33 54 211 0200 001 33 54 211 0400 001 33 54 211 0500 001 33 54 211 1000 001	double ended  a = length  	
<b>Fibre optic cable, single ended, single mode, metal</b> 1 x Han® 3 A, 2 x LC duplex  Length: a = 1 m a = 5 m a = 10 m a = 20 m a = 40 m a = 50 m a = 100 m	33 54 111 0010 001 33 54 111 0050 001 33 54 111 0100 001 33 54 111 0200 001 33 54 111 0400 001 33 54 111 0500 001 33 54 111 1000 001	Protection level: IP 65 / IP 67  single ended  a = length	
<b>Fibre optic breakout cable, single mode</b>  Length: 10 m Length: 20 m Length: 100 m	33 54 751 0100 001 33 54 751 0200 001 33 54 751 1000 001	PVC jacket 4-fibre single mode Outer diameter: 9.5 mm Min. bending radius: Installation: 15 x OD Operating: 10 x OD	

Further cable lengths are available on request



Identification	Part No.	Drawing	Dimensions in mm
<p>Fibre optic cable, double ended, multi mode, metal, 50 µm 2 x Han® 3 A, 2 x LC duplex</p> <p>Length: a = 1 m</p> <p>a = 5 m</p> <p>a = 10 m</p> <p>a = 20 m</p> <p>a = 40 m</p> <p>a = 50 m</p> <p>a = 100 m</p>	<p>33 54 211 0010 002</p> <p>33 54 211 0050 002</p> <p>33 54 211 0100 002</p> <p>33 54 211 0200 002</p> <p>33 54 211 0400 002</p> <p>33 54 211 0500 002</p> <p>33 54 211 1000 002</p>	<p>double ended</p> <p>a = length</p>	
<p>Fibre optic cable, single ended, multi mode, metal, 50 µm 1 x Han® 3 A, 2 x LC duplex</p> <p>Length: a = 1 m</p> <p>a = 5 m</p> <p>a = 10 m</p> <p>a = 20 m</p> <p>a = 40 m</p> <p>a = 50 m</p> <p>a = 100 m</p>	<p>33 54 111 0010 002</p> <p>33 54 111 0050 002</p> <p>33 54 111 0100 002</p> <p>33 54 111 0200 002</p> <p>33 54 111 0400 002</p> <p>33 54 111 0500 002</p> <p>33 54 111 1000 002</p>	<p>Protection level: IP 65 / IP 67</p> <p>single ended</p> <p>a = length</p>	
<p>Fibre optic breakout cable , multi mode, 50 µm</p> <p>Length: 10 m</p> <p>Length: 20 m</p> <p>Length: 100 m</p>	<p>33 54 751 0100 002</p> <p>33 54 751 0200 002</p> <p>33 54 751 1000 002</p>		<p>FRNC jacket</p> <p>4-fibre multi mode 50 µm</p> <p>Outer diameter: 7.9 mm</p> <p>Min. bending radius: 9.8 cm</p> <p>Installation: 9.8 cm</p> <p>Operating: 7.9 cm</p>



Identification	Part No.	Drawing	Dimensions in mm
<b>Hybrid fibre optic cable, single mode, double ended</b> 2 x FO + 3 x 2.5 mm <sup>2</sup> , 2 x Han® 3 A		double ended 	
Length: a = 1 m    AC version DC version	33 57 211 0015 003 33 57 211 0015 004		
a = 5 m    AC version DC version	33 57 211 0055 003 33 57 211 0055 004		
a = 10 m    AC version DC version	33 57 211 0105 003 33 57 211 0105 004		
a = 20 m    AC version DC version	33 57 211 0205 003 33 57 211 0205 004		
a = 40 m    AC version DC version	33 57 211 0405 003 33 57 211 0405 004		
a = 50 m    AC version DC version	33 57 211 0505 003 33 57 211 0505 004		
a = 100 m    AC version DC version	33 57 211 1005 003 33 57 211 1005 004		
<b>Hybrid fibre optic cable, single mode, single ended</b> 2 x FO + 3 x 2.5 mm <sup>2</sup> , 1 x Han® 3 A		single ended 	
Length: a = 1 m    AC version DC version	33 57 111 0015 003 33 57 111 0015 004		
a = 5 m    AC version DC version	33 57 111 0055 003 33 57 111 0055 004		
a = 10 m    AC version DC version	33 57 111 0105 003 33 57 111 0105 004		
a = 20 m    AC version DC version	33 57 111 0205 003 33 57 111 0205 004		
a = 40 m    AC version DC version	33 57 111 0405 003 33 57 111 0405 004		
a = 50 m    AC version DC version	33 57 111 0505 003 33 57 111 0505 004		
a = 100 m    AC version DC version	33 57 111 1005 003 33 57 111 1005 004		
<b>Hybrid fibre optic cable, single mode</b>			PVC jacket 2 x 9/125 + 3 x 2.5 mm <sup>2</sup> Outer diameter: 8.8 mm Min. bending radius: Installation: 9 cm Operating: 18 cm

Further cable lengths are available on request



Identification	Part No.	Drawing	Dimensions in mm
<p><b>Hybrid fibre optic cable, multi mode, double ended</b> 2 x G50/125 + 3 x 2.5 mm<sup>2</sup></p> <p>Length: a = 1 m AC version DC version</p> <p>a = 5 m AC version DC version</p> <p>a = 10 m AC version DC version</p> <p>a = 20 m AC version DC version</p> <p>a = 40 m AC version DC version</p> <p>a = 50 m AC version DC version</p> <p>a = 100 m AC version DC version</p>	<p>33 57 211 0015 001 33 57 211 0015 002</p> <p>33 57 211 0055 001 33 57 211 0055 002</p> <p>33 57 211 0105 001 33 57 211 0105 002</p> <p>33 57 211 0205 001 33 57 211 0205 002</p> <p>33 57 211 0405 001 33 57 211 0405 002</p> <p>33 57 211 0505 001 33 57 211 0505 002</p> <p>33 57 211 1005 001 33 57 211 1005 002</p>	<p>double ended</p> <p>a = length</p> <p>Protection level: IP 65 / IP 67</p>	
<p><b>Hybrid fibre optic cable, multi mode, single ended</b> 2 x G50/125 + 3 x 2.5 mm<sup>2</sup></p> <p>Length: a = 1 m AC version DC version</p> <p>a = 5 m AC version DC version</p> <p>a = 10 m AC version DC version</p> <p>a = 20 m AC version DC version</p> <p>a = 40 m AC version DC version</p> <p>a = 50 m AC version DC version</p> <p>a = 100 m AC version DC version</p>	<p>33 57 111 0015 001 33 57 111 0015 002</p> <p>33 57 111 0055 001 33 57 111 0055 002</p> <p>33 57 111 0105 001 33 57 111 0105 002</p> <p>33 57 111 0205 001 33 57 111 0205 002</p> <p>33 57 111 0405 001 33 57 111 0405 002</p> <p>33 57 111 0505 001 33 57 111 0505 002</p> <p>33 57 111 1005 001 33 57 111 1005 002</p>	<p>single ended</p> <p>a = length</p>	
<p><b>Hybrid fibre optic cable, multi mode, 50 µm</b></p> <p>Length: 10 m</p> <p>Length: 20 m</p> <p>Length: 500 m</p>	<p>33 57 851 0100 002</p> <p>33 57 851 0200 002</p> <p>33 57 851 5000 002</p>	<p>PVC jacket</p> <p>2 x G50/125 + 3 x 2.5 mm<sup>2</sup></p> <p>Outer diameter: 12.6 mm</p> <p>Min. bending radius: single: 5 x OD repeated: 10 x OD</p>	



HARTING PushPull type acc. to IEC 61076-3-106 variant 4  
LC duplex panel feed-through and connector

## Advantages

- Optical PushPull connector based on LC with small form factor (requires 50 % compared to SC and ST)
- EasyInstall and Compact panel feed-through for simple device integration
- Optical module with inserts acc. to IEC 61 754-20
- One-piece LC body assures high mechanical stability
- A & B parts identification for Duplex according TIA 568 standard

## Technical characteristics

Locking	PushPull Technology acc. to IEC 61 076-3-106 variant 4
Degree of protection	IP 65 / IP 67
Mating face	LC acc. to IEC 61754-20
Mating cycles	min. 200
Temperature range	-40 °C ... +70 °C
Housing material	Plastic, black
Flammability acc. to UL 94	V 0

Identification	Part No.	Drawing	Dimensions in mm
----------------	----------	---------	------------------

### HARTING PushPull LC duplex

Device side EasyInstall version

Multimode GOF

09 57 441 0500 000

09 57 468 0500 000  
(metal version)

Singlemode GOF

09 57 441 0501 000

09 57 468 0501 000  
(metal version)

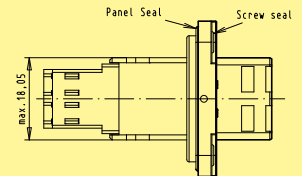
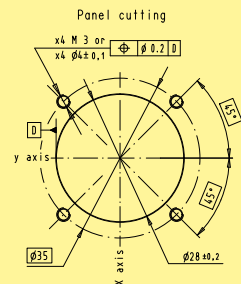
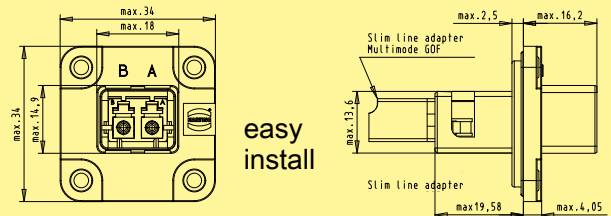

Device side Compact version

Multimode GOF

09 57 442 0502 001

Singlemode GOF

09 57 442 0503 001

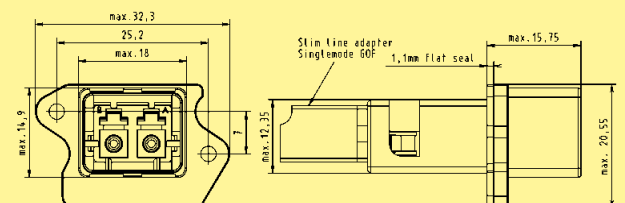



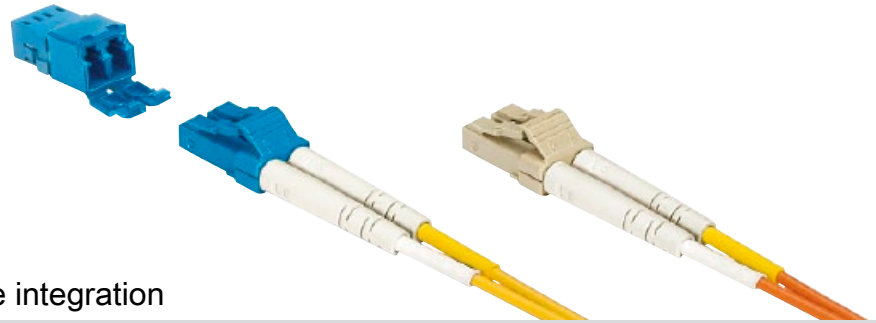

LC duplex IP 20 adapter for device integration

## Advantages

- Small form factor requires 50 % (compared to SC and ST)
- Compact, space-saving design
- High packing density
- A & B parts identification according TIA 568 standard
- Complement adapter for IP 67 connector on device side

## Technical characteristics

Degree of protection	IP 20
Mating interface	LC duplex with two fibres
Temperature range	-40 °C ... +70 °C

Identification	Part No.	Drawing	Dimensions in mm															
Device side																		
Adapter																		
Multimode GOF	09 57 400 0003 000																	
Singlemode GOF	09 57 400 0004 000																	
Connector LC duplex																		
Multimode GOF	09 57 400 0001 000		<table border="1"> <thead> <tr> <th></th> <th>min.</th> <th>max.</th> </tr> </thead> <tbody> <tr> <td>G</td> <td>26.60</td> <td>26.80</td> </tr> <tr> <td>H</td> <td>9.35</td> <td>9.45</td> </tr> <tr> <td>J</td> <td>12.80</td> <td>12.90</td> </tr> <tr> <td>K</td> <td>15.24</td> <td>15.34</td> </tr> </tbody> </table>		min.	max.	G	26.60	26.80	H	9.35	9.45	J	12.80	12.90	K	15.24	15.34
	min.			max.														
G	26.60	26.80																
H	9.35	9.45																
J	12.80	12.90																
K	15.24	15.34																
Singlemode GOF	09 57 400 0002 000																	

Identification	Part No.	Drawing	Dimensions in mm
<p><b>Transport protection</b> for device side IP 40</p>	09 45 845 0003		
<p><b>Protection cover</b> for device side IP 65 / IP 67</p>	09 45 845 0009 024		
<p>Version with passive locking without cord</p>	09 45 845 0009		
<p>Version with passive locking with plastic cord for fixing screw M3</p>	09 45 845 0011 024		
<p>Version with passive locking with nylon cord for fixing screw M2.5 / M3</p>	09 45 845 0015		
<p>Version with active locking without cord</p>	09 45 845 0014		
<p>Version with active locking with plastic cord for fixing screw M3</p>	09 45 845 0013		
<p>Version with active locking with nylon cord for fixing screw M2.5 / M3</p>	09 45 845 0010		
<p><b>Protection cover</b> for connectors IP 65 / IP 67</p>	09 45 845 0020		
<p><b>Security clip</b> for connectors can be sealed and protects against unauthorized unplugging</p>			



Han® PushPull, type acc. to IEC 61 076-3-117 variant 14  
SCRJ connector

## Features

- HARTING PushPull technology
- Compact design
- High packing density
- Han® PushPull SCRJ for POF is according the requirements of AIDA (German Domestic Automobile Manufacturers)
- Field installable

## Technical characteristics

Locking	PushPull technology
Degree of protection	IP 65 / IP 67
Mating face	SCRJ acc. to IEC 61 754-24
Fiber Typen	POF <sup>1)</sup> 1 mm HCS <sup>2)</sup> 200 µm / 230 µm MM 62.5 µm / 125 µm MM 50 µm / 125 µm SM 10 µm / 125 µm
Mating cycles	min. 750
Temperature range	-40 °C ... +70 °C
Housing material	Plastic, black
Flammability acc. to UL 94	V 0
Cable diameter	6.5 - 9.5 mm

Identification	Part No.	Drawing	Dimensions in mm
----------------	----------	---------	------------------

Connector set, plastic  
incl. housing and SCRJ insert,  
POF contacts

09 35 241 0421

PROFINET-Identification:  
PROFINET O-Plug SCRJ

incl. housing and SCRJ insert  
SC contacts order separately

09 35 241 0422

SCRJ IP 20  
POF connector

09 35 002 4002

Dust protection cover IP 40

09 35 002 5412

Protection cover IP 65 / IP 67

09 35 002 5411

Contacts

SC POF contact, 1 mm  
SC 125 GI contact  
SC 230 HCS contact

20 10 001 5217  
20 10 125 5211  
20 10 230 5211

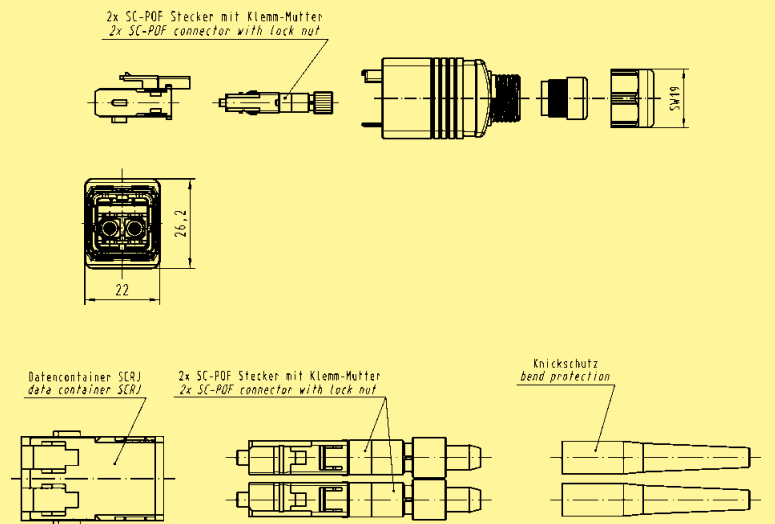



Han® PushPull, type acc. to IEC 61 076-3-117 variant 14  
 Housing bulkhead mounting for device integration  
 Optical connector based on SCRJ

## Features

- HARTING PushPull technology
- Compact design
- High packing density
- Device integration via transceiver
- Han® PushPull SCRJ for POF is according the requirements of AIDA (German Domestic Automobile Manufacturers)

## Technical characteristics

Locking	PushPull technology
Degree of protection	IP 65 / IP 67
Mating face	SCRJ acc. to IEC 61 754-24
Fiber Typen	POF <sup>1)</sup> 1 mm HCS <sup>2)</sup> 200 µm / 230 µm MM 62.5 µm / 125 µm MM 50 µm / 125 µm SM 10 µm / 125 µm
Mating cycles	min. 750
Temperature range	-40 °C ... +70 °C
Housing material	Zinc die-cast, nickel plated

### Identification

### Part No.

### Drawing

### Dimensions in mm

#### Components device side

Housing bulkhead mounting  
 Optical transceiver  
 not included

metal

09 35 002 0303

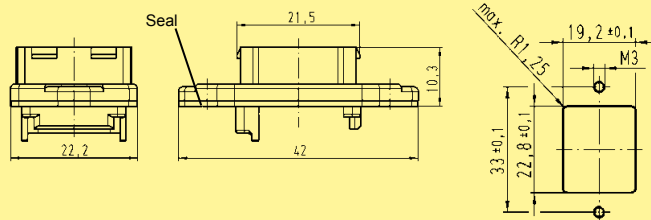

Dust protection cover IP 40  
 rubber (NBR)

09 35 002 5401

Protection cover IP 65 / IP 67

09 35 002 5402

Reference for transceiver  
 as well as mounting instruction  
 on request

1) POF = Polymer-Optical Fibre  
 2) HCS® = Hard Clad Silica (registered trademark of SpecTran Corporation)



Han® PushPull, type acc. to IEC 61 076-3-117 variant 14  
 RJ45 panel feed through  
 for optical connector based on SCRJ



## Features

- HARTING PushPull technology
- Compact design
- High packing density
- Han® PushPull SCRJ for POF is according the requirements of AIDA (German Domestic Automobile Manufacturers)

## Technical characteristics

Locking	PushPull technology
Degree of protection	IP 65 / IP 67
Mating face	SCRJ acc. to IEC 61 754-24
Fiber Typen	POF <sup>1)</sup> 1 mm HCS <sup>2)</sup> 200 µm / 230 µm MM 62.5 µm / 125 µm MM 50 µm / 125 µm SM 10 µm / 125 µm
Mating cycles	min. 750
Temperature range	-40 °C ... +70 °C
Housing material	Zinc die-cast, nickel plated

### Identification

### Part No.

### Drawing

### Dimensions in mm

Han® PushPull SCRJ

Panel feed through

SC contacts order separately

09 35 242 0313

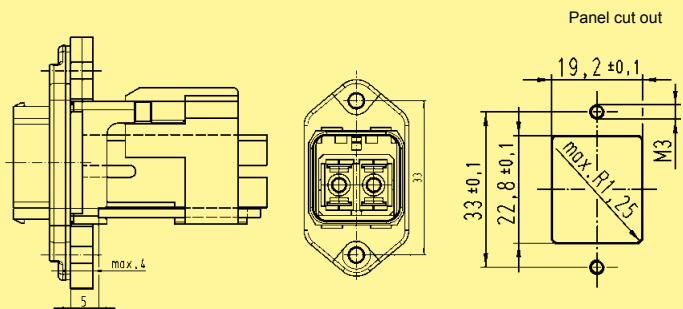

SCRJ IP 20  
POF connector

09 35 002 4002

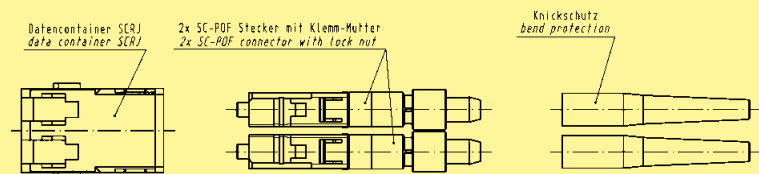

### Contacts

- SC POF contact, 1 mm
- SC 125 GI contact
- SC 230 HCS contact

20 10 001 5217  
 20 10 125 5211  
 20 10 230 5211



Han® PushPull, type acc. to IEC 61 076-3-117 variant 14  
SCRJ connector



## Features

- HARTING PushPull technology
- Compact design
- High packing density
- Han® PushPull SCRJ for POF is according the requirements of AIDA (German Domestic Automobile Manufacturers)
- Field installable

## Technical characteristics

Locking	PushPull technology
Degree of protection	IP 65 / IP 67
Mating face	SCRJ acc. to IEC 61 754-24
Fiber Typen	POF <sup>1)</sup> 1 mm HCS <sup>2)</sup> 200 µm / 230 µm MM 62.5 µm / 125 µm MM 50 µm / 125 µm SM 10 µm / 125 µm
Mating cycles	min. 750
Temperature range	-40 °C ... +70 °C
Housing material	Zinc die-cast, nickel plated
Flammability acc. to UL 94	V 0
Cable diameter	6.5 - 9.5 mm

### Identification

### Part No.

### Drawing

### Dimensions in mm

#### Connector set, metal

incl. housing and SCRJ insert,  
POF contacts

09 35 241 0401

PROFINET-Identification:  
PROFINET O-Plug SCRJ

incl. housing and SCRJ insert  
SC contacts order separately

09 35 241 0402

#### SCRJ IP 20 POF connector

09 35 002 4002

#### Dust protection cover IP 40

09 35 002 5412

#### Protection cover IP 65 / IP 67

09 35 002 5411

#### Contacts

SC POF contact, 1 mm  
SC 125 GI contact  
SC 230 HCS contact

20 10 001 5217  
20 10 125 5211  
20 10 230 5211

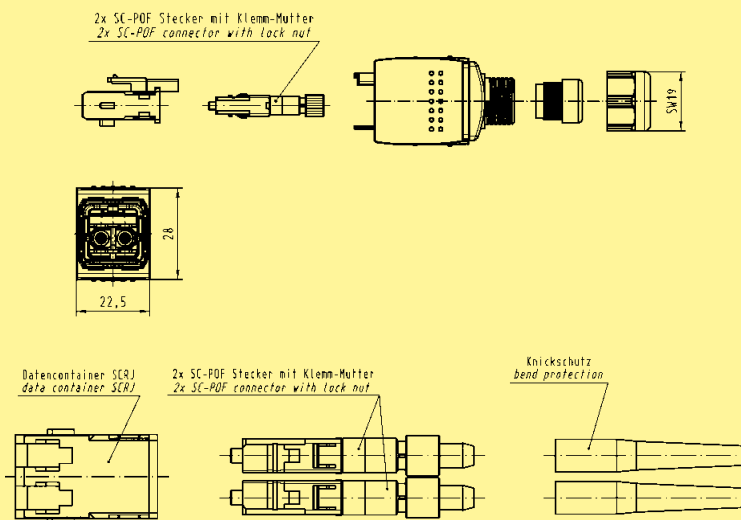



## Han® PushPull SCRJ POF Assembly tools for polymer-optical fibres

### Features

- Cable insulation (PUR / PVC) is stripped without damage
- The 'stripping' and 'precision cutting' operations are completed within the one tool
- Specialized cutting method with an automatically advancing round blade for an accurate cutting result requiring no final polishing
- Optical display indicating remaining operations
- Simultaneous handling of twin fibers (duplex mode)

### Technical characteristics

Connector type	SCRJ connector acc. to IEC 61 754-24
Locking	PushPull technology acc. to IEC 61 076-3-117 variant 14 (AIDA compliant)
Insertion loss	typically 1.5 to 2.0 dB
Termination SC contacts	Fast termination technique, reusable
Fibre dimensions	POF 980 / 1000 µm
Fibre outer diameter	2.2 mm
Cable outer diameter	7 to 8.5 mm
No. of cutting operations	Maximum 1260

#### Identification

#### Part No.

#### Drawing

#### Dimensions in mm

Assembly tool set for POF cutting, without final polishing

- The set contains
- one stripping and cutting tool for 1260 operations
  - one sheath stripping tool
  - one Kevlar shear
  - one positioner for SCRJ contacts
- Supplied in a robust plastic case

09 35 000 9913

Replacement cutting tool for 1260 operations

09 35 000 9914

Assembly tool set for POF cutting, with final polishing

- Without an optical meter
- With an optical meter

20 99 000 3016

20 99 000 3013

Polishing wheel (grinding wheel) for POF cables 2.2

20 99 000 1099

Sand paper for POF, grain size 1000

20 80 001 9911

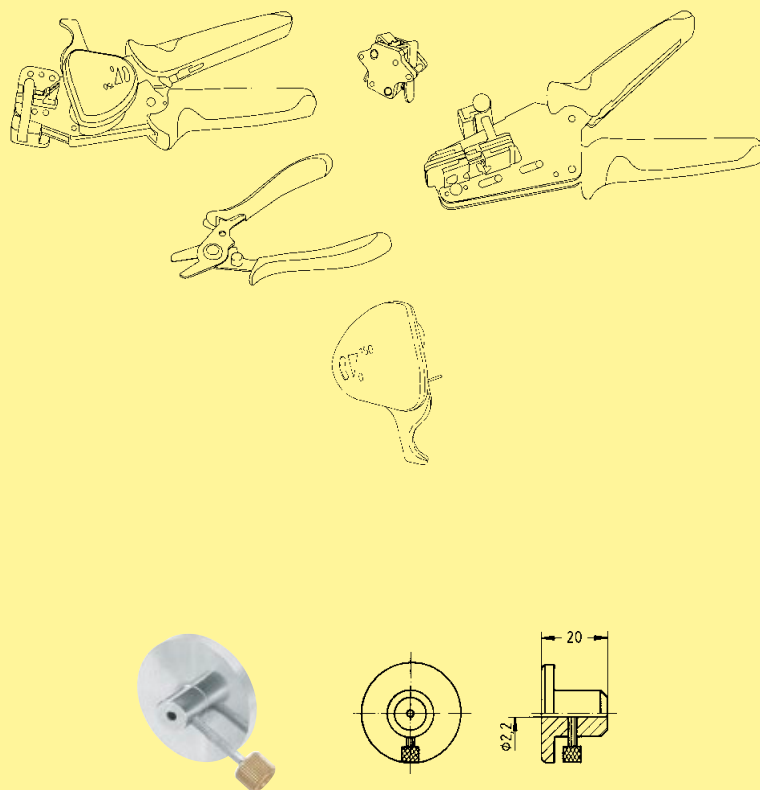



## Han® 3 A 2 x LC duplex

### Advantages

- Compact, space-saving Design
- Just one LWL modul for high mechanical load
- High packing density
- A & B parts identification according to TIA 568 standard

### Technical characteristics

Degree of protection	IP 65 / IP 67
Temperature range	-40 °C ... +70 °C
Housing material	Zinc die-cast powder coating black

#### Identification

#### Part No.

#### Drawing

#### Dimensions in mm

#### Components device side

Multimode GOF  
Singlemode GOF

09 57 467 0004 000  
09 57 467 0005 000

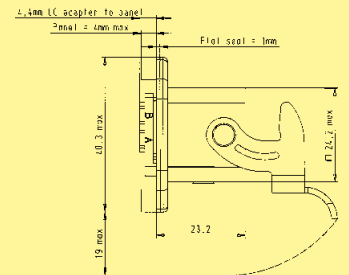
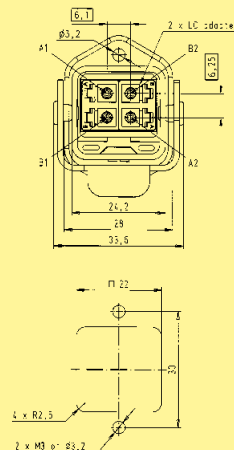

#### Connector

Multimode GOF  
Singlemode GOF

09 57 407 0001 000  
09 57 407 0002 000

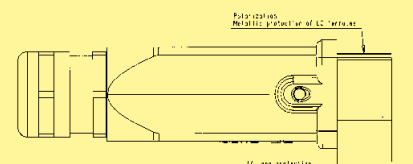
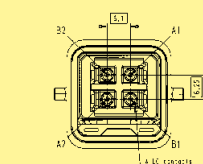





## Han® 3 A LC duplex Hybrid

### Advantages

- Small form factor (compared to SC and ST®)
- Compact, space-saving Design
- Combined to only one LWL-module for high mechanical load
- High packing density
- A & B parts identification according to TIA 568 standard

### Technical characteristics

Degree of protection	IP 65 / IP 67
Temperature range	-40 °C ... +70 °C
Data	
Mating module	LC duplex (2 fibres)
Cable diameter	6.0 ... 9.0 mm
Power	
Number of contacts	3 (AC: L1, PE, N / DC: V+, GND, V-)
Working voltage	300 V AC/DC
Working current	12 A @ 70°C
Number of contacts	3 (AC: L1, PE, N / DC: V+, GND, V-)
Housing material	Aluminium die-cast, black

### Identification

### Part No.

### Drawing

### Dimensions in mm

#### Components device side

Power: 3x Han D® male contacts

Data: Multimode GOF	AC	09 57 568 0500 000
	DC	09 57 568 0510 000

Data: Singlemode GOF	AC	09 57 568 0501 000
	DC	09 57 568 0511 000

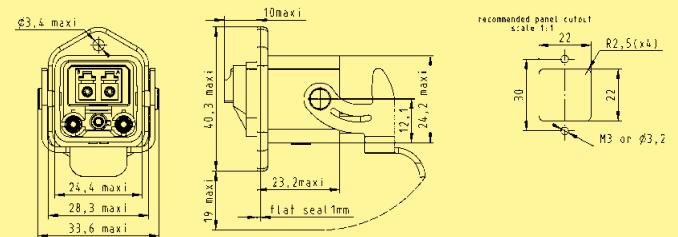

#### Connector

Power: 3x Han D® female contacts

Data: Multimode GOF	AC	09 57 508 0500 000
	DC	09 57 508 0510 000

Data: Singlemode GOF	AC	09 57 508 0501 000
	DC	09 57 508 0511 000

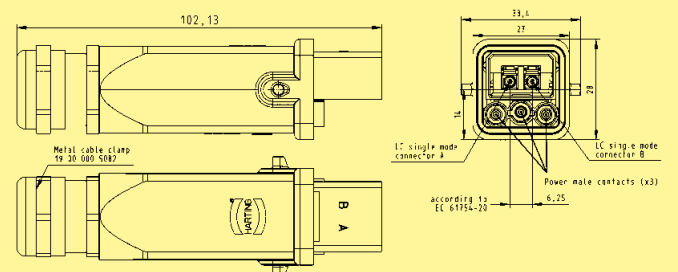



## Features

Advantages of the HARTING quick-assembly technique:

- No special tools necessary
- Quick, cost-effective assembly
- No crimping, no glueing
- Fixed connection due to metallic type
- Suitable for 1 mm polymer fibre  
2.2 mm jacket

## Technical characteristics

Assembly of the single connectors:

- Cut the cable
- Strip the jacket
- Insert of the fibre
- Tighten the sleeve nut
- Polish the connector's tip

Assembly of the coupling sleeve:

- Cut the cable's ends
- Insert in the coupling sleeve
- Tighten the sleeve nut

# Quick-assembly Connector for 1 mm POF<sup>1)</sup>

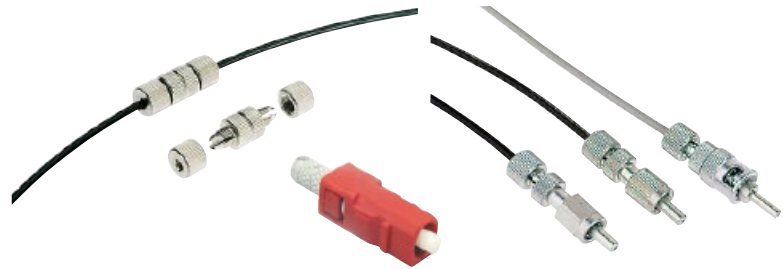

Quick-assembly connector for polymer fibre (POF<sup>1)</sup>)

Identification	Part number	Drawing	Dimensions in mm
<b>Quick-assembly connector</b> for 1 mm polymer fibre cable $\varnothing$ 2.2 mm  F-SMA type with hexagonal nut bending - without protection	<b>20 10 001 1212</b>		
with knurled nut bending - without protection	<b>20 10 001 1215</b>		
with bend protection sleeve	<b>20 10 001 1217</b>		
F-ST type - without protection	<b>20 10 001 2212</b>		
SC contact	<b>20 10 001 5217</b> <b>20 10 001 5218</b>		
<b>Coupling sleeve</b> or 1 mm polymer fibre cable $\varnothing$ 2.2 mm		Delivery range:	
Standard-Set	<b>20 80 000 1065</b>	4 x quick assembly cable coupler 1 x cutter	
Standard-Set	<b>20 80 000 1066</b>	10 x quick assembly cable coupler	

<sup>1)</sup> POF = Polymer Optical Fibre

# Single Connectors for 1 mm POF<sup>1)</sup>

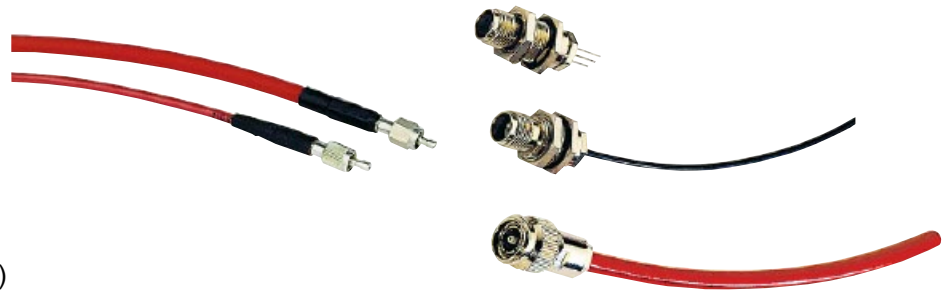

Single connectors for fibre optical cables (POF<sup>1)</sup>)

Identification	Part number	Drawing	Dimensions in mm
<p>F.O. connectors for 1 mm polymer fibre cable Ø 2.2 mm</p> <p>F-SMA type with hexagonal nut</p>	20 10 001 1211		<p>The connector for 1 mm POF may be directly attached to the fibre by crimping, glueing or by using a "hot plate".</p> <p>Insertion loss: POF &lt; 2.5 dB</p>
F-ST type	20 10 001 2211		
Versatile Link HFBR type Crimp	20 10 001 7111		
Crimpleless	20 10 001 7112		
SC contact	20 10 001 5211		
<p>für 1 mm Kunststoff-Faser; 3,6 mm SERCOS Kabel</p> <p>F-SMA type mit Sechskantmutter</p>	20 10 001 1241		
<p>for 1 mm polymer fibre cable 3.6 mm SERCOS</p> <p>F-SMA type with hexagonal nut</p>	20 10 001 1221		
F-TNC (IP 65)			
Male cable connector for 1 mm polymer fibre cable SERCOS Ø 6 mm	20 10 001 6211		
Female cable connector for 1 mm polymer fibre cable Ø 2.2 mm	20 10 001 6233		



F.O. single connectors with glass fibres

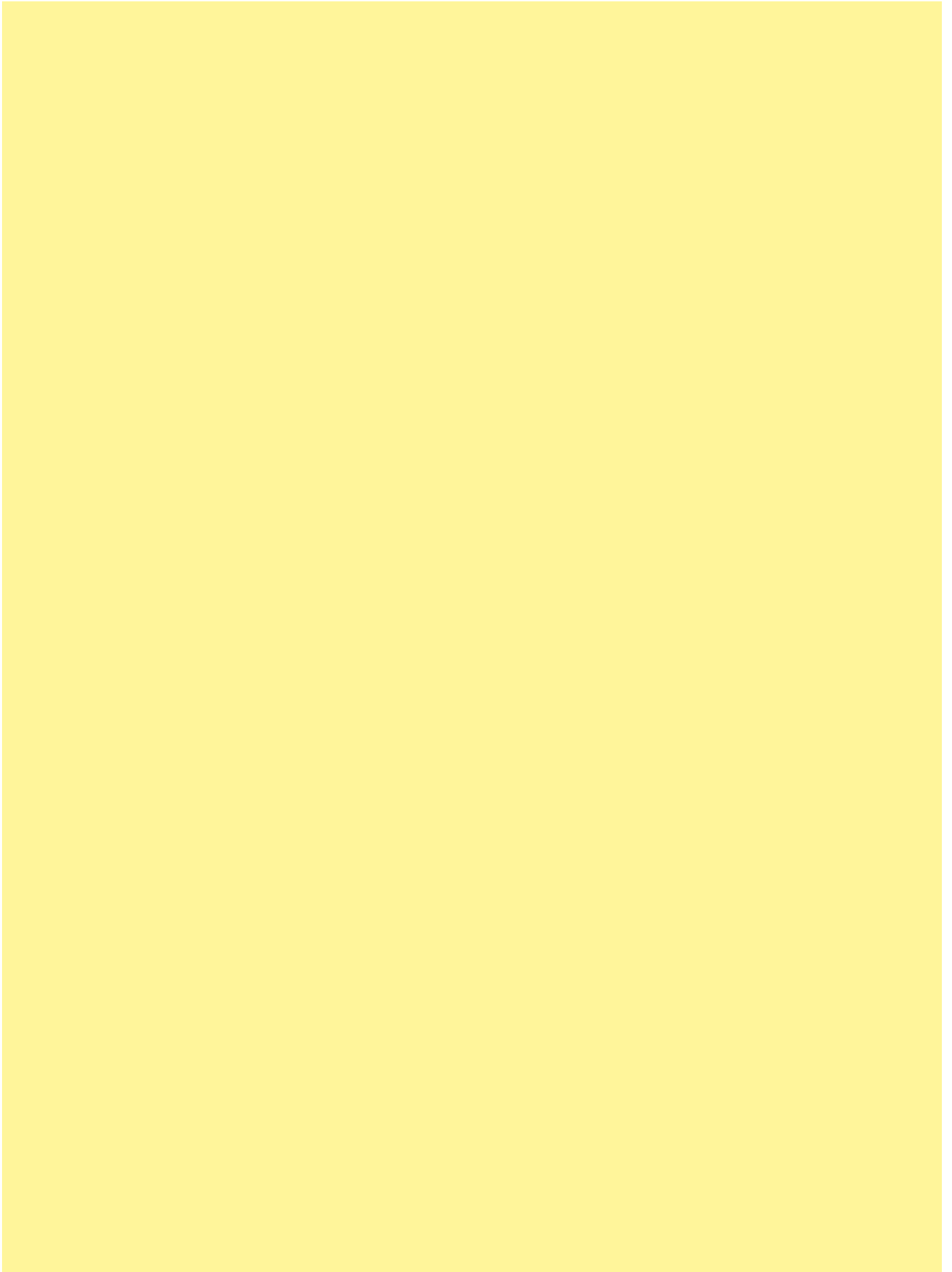

Identification	Part number	Drawing	Dimensions in mm
<p>F.O. connectors for GI-fibre 50 µm ... 62.5 / 125 µm</p> <p>F-SMA type for cable Ø 2.8 mm</p> <p>F-ST type for cable Ø 2.8 mm</p> <p>SC contact</p>	<p>20 10 125 1212</p> <p>20 10 125 2212</p> <p>20 10 125 5211</p>	<p>F-SMA type</p> <p>The ferrule of the FO connector for GI-fibre is ceramic. Insertion loss: F-SMA GI / SI &lt; 1.0 dB</p> <p>F-ST type</p> <p>Insertion loss: F-ST GI / SI &lt; 0.5 dB</p>	
<p>for SI-fibre (HCS® 1) 200 / 230 µm</p> <p>F-SMA type for cable Ø 2.8 mm</p> <p>F-ST type for cable Ø 2.8 mm</p> <p>Versatile Link type for cable Ø 2.8 mm</p>	<p>20 10 230 1212</p> <p>20 10 230 2212</p> <p>20 10 230 7111</p>		
<p>Coupling sleeve</p> <p>F-SMA type</p> <p>F-ST type</p>	<p>20 80 000 1071</p> <p>20 80 000 1021</p>	<p>F-SMA connector and coupling sleeve acc. to IEC 874-2</p> <p>FH-ST connector and coupling sleeve acc. to IEC 874-10 CECC 86123-801</p>	

<sup>1)</sup> HCS® (= Hard Clad Silica) is registered trade mark of SpecTran Corporation







Function Class	Installation Class	Switches	
<p><b>Ha-VIS eCon</b></p> <p><b>unmanaged</b></p> <ul style="list-style-type: none"> <li>Plug &amp; Play</li> <li>Store and Forward Switching Mode</li> <li>Non-Blocking</li> <li>Auto-negotiation</li> <li>Auto-polarity</li> <li>Auto-crossing</li> </ul>	<p>Inside (IP 30 Protection Class)</p>	<p><b>Ha-VIS eCon 3000</b></p> <ul style="list-style-type: none"> <li>- 1/6/8 Copper ports with 1/2 F.O. ports</li> <li>- Robust metal housing</li> <li>- Top-Hat Rail mount</li> <li>- Narrow form factor</li> </ul>	 <p><b>Ha-VIS eCon 3061-AD</b> 6 RJ45, 1 SC</p> <p><b>Ha-VIS eCon 3061-AE</b> 6 RJ45, 1 ST</p>  <p><b>Ha-VIS eCon 3062-AD/-AD2/-AF</b> 6 RJ45, 2 SC also available with: - Extended temperature range (-AD2) - Single mode (-AF)</p> <p><b>Ha-VIS eCon 3062-AE</b> 6 RJ45, 2 ST</p>
<p><b>Ha-VIS sCon</b></p> <p><b>configurable</b></p> <ul style="list-style-type: none"> <li>Plug &amp; Play via USB-interface</li> <li>configurable through a graphic user interface</li> </ul>	<p>Inside (IP 30 Protection Class)</p>	<p><b>Ha-VIS sCon 3000</b></p> <ul style="list-style-type: none"> <li>- 6 / 8 Copper ports (RJ45) and 2 / 3 F.O. ports (SC)</li> <li>- Robust metal housing</li> <li>- Parallel-/ ring-redundancy</li> <li>- Top-Hat rail mounting</li> <li>- Potential-free alarm contact</li> </ul>	 <p><b>Ha-VIS sCon 3082-AD/-AF</b> 8 RJ45, 2 SC</p> <p><b>Ha-VIS sCon 3063-AD</b> 6 RJ45, 3 SC</p>
<p><b>Ha-VIS mCon</b></p> <p><b>managed</b></p> <ul style="list-style-type: none"> <li>Webinterface</li> <li>SNMP (v1, v2c, v3)</li> <li>User Management</li> <li>LLDP</li> <li>Quality of Service</li> <li>VLAN support</li> <li>Rapid Spanning Tree</li> <li>802.1X</li> <li>RADIUS Client</li> <li>IP authorize manager</li> <li>IGMP Snooping (v1, v2, v3) with querier</li> <li>DHCP Client</li> <li>DHCP Option 82</li> <li>SNTP</li> <li>Alarms via Email</li> <li>SNMP Traps</li> <li>Port diagnostic</li> </ul>	<p>Inside (IP 30 Protection Class)</p>	<p><b>Ha-VIS mCon 3000</b></p> <ul style="list-style-type: none"> <li>- 6 / 8 / 10 Copper ports (RJ45) and 2 / 3 F.O.-ports (SC / ST)</li> <li>- Robust metal housing</li> <li>- Top-Hat rail mounting</li> <li>- Web management</li> <li>- Potential-free alarm contact</li> </ul> <p><b>Ha-VIS mCon 3000 NG</b></p> <ul style="list-style-type: none"> <li>- 8 Copper ports (RJ45) and 2 F.O. ports (SFP Combo ports)</li> <li>- Robust metal housing</li> <li>- Top-Hat rail mounting</li> <li>- Web management</li> <li>- Slot for SD cards</li> </ul>	<p><b>Ha-VIS mCon 3061-ADV</b> 6 RJ45, 1 SC</p> <p><b>Ha-VIS mCon 3082-ADV</b> 8 RJ45, 2 SC</p> <p><b>Ha-VIS mCon 3063-ADV</b> 6 RJ45, 3 SC</p> <p><b>Ha-VIS mCon 3061-AEV</b> 6 RJ45, 1 ST</p> <p><b>Ha-VIS mCon 3082-AEV</b> 8 RJ45, 2 ST</p> <p><b>Ha-VIS mCon 3063-AEV</b> 6 RJ45, 3 ST</p> <p><b>Ha-VIS mCon 3102-AASFP</b> 8 RJ45, 2 SFP</p>



## Ethernet Media converter Ha-VIS eCon 3011

Ethernet Media converter, unmanaged,  
for installation in control cabinets

### General Description

The Fast Ethernet Media converter Ha-VIS eCon3011 of the product family Ha-VIS eCon 3000 is suitable for industrial applications and support both Ethernet (10 Mbit/s) and Fast Ethernet (100 Mbit/s). The Media-converter enables the conversion from Twisted Pair cables to fiber-optic cables (Multimode and Single-mode).

The Ha-VIS eCon 3011 Mediaconverter is configurable via Dip Switch and offers a variety of control functions.

The Mediaconverter has two operating modes:

In the **switch mode**, it operates as an unmanaged Ethernet Switch with Store and Forward Switching which supports asynchronous data communication, Auto-crossing and Auto-negotiation.

In the **converter mode**, it works with a data rate of 100 Mbit/s (Full duplex). The latency is very low in this operation mode.

### Features

- Converter Mode with a very low latency
- Store and Forward switch mode
- Link Fault Path Through (LFP)
- Power over Ethernet (Power Source Equipment)
- 9 kByte Jumbo Frames in converter mode
- 2 kByte Frames in switch mode

### Advantages

- Power over Ethernet (IEEE 802.3af)
- Configuration via Dip Switch
- Small and robust metal housing
- Adapted for mounting onto top-hat mounting rail 35 mm according to EN 60 715

### Application fields

- Industrial automation
- Automotive industry
- Wind power
- Power distribution systems

## Technical characteristics Media converter

### Ethernet interface RJ45

Number of ports	1x 10/100Base-T(X)
Cable types according to IEEE 802.3	Shielded Twisted Pair (STP) or Unshielded Twisted Pair (UTP), Category 5
Data rate	10 Mbit/s or 100 Mbit/s (RJ45)
Repeater class	Class II (latency 860 ns in converter mode)
Maximum cable length	100 m (Twisted Pair; with Category 5 cable acc. to DIN EN 50 173-1)
Termination	RJ45 (Twisted Pair)
Diagnostics (via LED)	<ul style="list-style-type: none"> <li>• Status Link – Green</li> <li>• Data transfer (Act) – Green flashing</li> <li>• Data transfer rate (Speed) – 100 Mbit/s: Yellow / 10 Mbit/s: OFF</li> <li>• Duplex – Full duplex: Yellow / Half duplex: OFF</li> <li>• PoE (Power Source Equipment) (PSE) – Green</li> </ul>
Topology	Line

### Power supply

Input voltage	24 V DC (12 V ... 30 V DC)
Input voltage, mode PoE	48 V DC (46 V ... 57 V DC)
Termination	5-pole pluggable screw contact (PRW1 + / PWR1 - / PWR2 + / PWR2 - / PE)
Diagnostics (via LED)	Power supply - Green

### Configuration

via DIP switches:  
Mode, Auto-negotiation, Data rate, Duplex TP, Duplex FX, Link monitoring, PoE (PSE)

### Design features

Housing material	Metal (powder coated)
Dimensions (W x H x D)	23 x 130 x 100 mm (without connectors)
Degree of protection acc. to DIN 60529	IP 30
Mounting	35 mm top-hat rail acc. to EN 60715
Weight	approx. 0.6 kg

### Environmental conditions

Operating temperature	-40 °C ... +70 °C
Storage temperature	-40 °C ... +85 °C
Relative humidity	10 % ... 95 % (non-condensing)

## Technical characteristics Media converter - F.O. termination

### Ethernet interface – F.O.

Number of ports	1x 100Base-FX
Cable types according to IEEE 802.3	Multimode fibre, 1300 nm; 50 / 125 $\mu\text{m}$ or 62.5 / 125 $\mu\text{m}$
Data rate	100 Mbit/s
Link monitoring	Link Fault Pass-Through (LFP)
Maximum cable length	2000 m (Multimode)
Termination	SC-D female
Diagnostics (via LED)	<ul style="list-style-type: none"> <li>• Status Link – Green</li> <li>• Data transfer (Act) – Green flashing</li> <li>• Duplex – Full duplex: Yellow / Half duplex: OFF</li> </ul>
Wavelength	1300 nm
Transceive power T(X) max. (dynamic)	<ul style="list-style-type: none"> <li>• -14 dBm (50 / 125 <math>\mu\text{m}</math>)</li> <li>• -14 dBm (62.5 / 125 <math>\mu\text{m}</math>)</li> </ul>
Transmission power T(X) min.	<ul style="list-style-type: none"> <li>• -23.5 dBm (50 / 125 <math>\mu\text{m}</math>)</li> <li>• -20 dBm (62.5 / 125 <math>\mu\text{m}</math>)</li> </ul>
Receive power RX typical (dynamic)	<ul style="list-style-type: none"> <li>• -33.9 dBm (window)</li> <li>• -35.2 dBm (centre)</li> </ul>
Receive power RX max. (dynamic)	-14 dBm
Signal detection (dynamic)	-33 dBm
Topology	Line

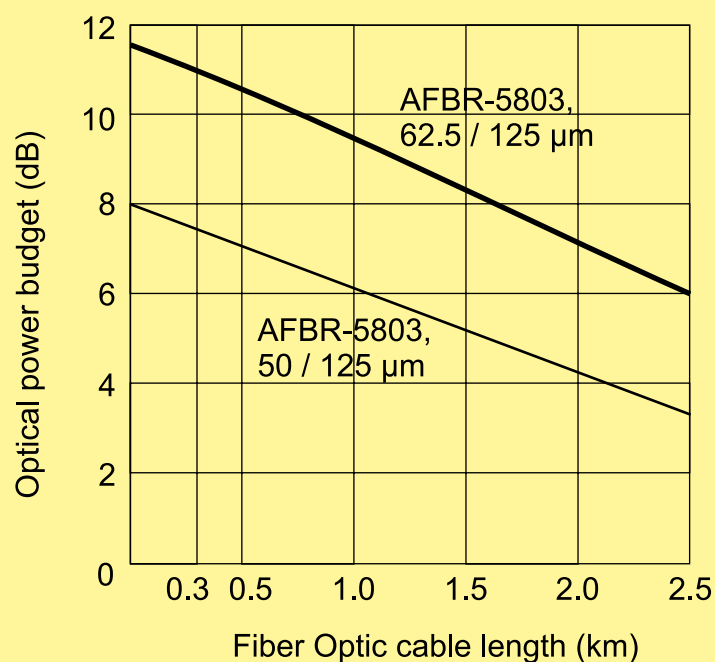



## Ethernet Media converter Ha-VIS eCon 3011-AD

2-port Ethernet Media converter for vertical installation  
in control cabinets including 1 F.O. port (SC, MM)

Unmanaged	IP 30	PROFINET compatible <input checked="" type="checkbox"/>	EtherNet/IP compatible <input type="checkbox"/>
-----------	-------	---	---

Number of ports, Copper / Termination	1x 10/100Base-T(X) / RJ45 (Twisted Pair)
Number of ports, F.O. / Termination	1x 100Base-FX / SC-D female
Input voltage / Termination	24 V DC / 5-pole pluggable screw contact, redundancy (PRW1 + / PWR1 - / PWR2 + / PWR2 - / PE)
Permissible range (min/max)	12 V ... 48 V DC
Input voltage mode PoE	48 V DC when using as PSE
Permissible range (min/max)	46 V ... 57 V DC
Input current	approx. 100 mA (at 24 V DC) approx. 100 ... 400 mA (at 48 V DC with PoE)
Housing material	Metal (powder coated)
Dimensions (W x H x D)	23 x 130 x 100 mm (without connectors)
Weight	approx. 0.6 kg
Operating temperature	-40 °C ... +70 °C
Approvals	cUL (in preparation)

Identification	Part number	Drawing	Dimensions in mm
----------------	-------------	---------	------------------

Ha-VIS eCon 3011-AD  
Ethernet Media converter with  
1 RJ45 port  
1 F.O. port

20 76 102 3100

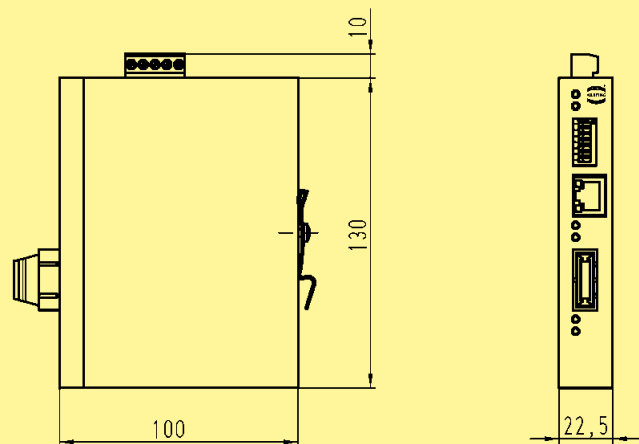



## Ethernet Media converter Ha-VIS eCon 3011-ASFP

2-port Ethernet Media converter for vertical installation  
in control cabinets including 1 F.O. port (SFP)

Unmanaged	IP 30	PROFINET compatible <input checked="" type="checkbox"/>	EtherNet/IP compatible <input type="checkbox"/>
-----------	-------	---	---

Number of ports, Copper / Termination	1x 10/100Base-T(X) / RJ45 (Twisted Pair)
Number of ports, F.O. / Termination	1x 100 Mbit/s SFP module slot
Input voltage / Termination	24 V DC / 5-pole pluggable screw contact, redundant (PRW1 + / PWR1 - / PWR2 + / PWR2 - / PE)
Permissible range (min/max)	12 V ... 48 V DC
Input voltage mode PoE	48 V DC when using as PSE
Permissible range (min/max)	46 V ... 57 V DC
Input current	approx. 100 mA (at 24 V DC) approx. 100 ... 400 mA (at 48 V DC with PoE)
Housing material	Metal (powder coated)
Dimensions (W x H x D)	23 x 130 x 100 mm (without connectors)
Weight	approx. 0.6 kg
Operating temperature	-40 °C ... +70 °C
Approvals	cUL (in preparation)

Identification	Part number	Drawing	Dimensions in mm
<p>Ha-VIS eCon 3011-ASFP</p> <p>Ethernet Media converter with 1 RJ45 port 1 port SFP module slot</p> <p>SFP modules on request</p>	20 76 102 3101		<p>100</p> <p>130</p> <p>22,5</p>



## Accessories SFP modules

General Description	Features									
<p>SFPs (<b>S</b>mall <b>F</b>orm-factor <b>P</b>luggable) are small standardized modules for network connections.</p> <p>These modules are a specification for a new generation of modular optical transceivers. The devices are constructed as connecting plugs for extremely quick network connections.</p> <p>The SFPs are available in a variety of models, depending on the cable type (multi-mode or single-mode), the wave length (850 nm, 1300 nm, 1550 nm or CWDM), data rate or range. Copper-based SFP are also available.</p>	<p>SFP modules</p> <ul style="list-style-type: none"> <li>• Highly flexible</li> <li>• Easily swapped out in event of malfunction</li> <li>• Hot swappable</li> <li>• Variants:</li> </ul> <table border="1" data-bbox="863 887 1382 1025"> <thead> <tr> <th></th> <th>SM fibre</th> <th>MM fibre</th> </tr> </thead> <tbody> <tr> <td>100 Mbit/s</td> <td>X</td> <td>X</td> </tr> <tr> <td>1000 Mbit/s</td> <td>X</td> <td>X</td> </tr> </tbody> </table>		SM fibre	MM fibre	100 Mbit/s	X	X	1000 Mbit/s	X	X
	SM fibre	MM fibre								
100 Mbit/s	X	X								
1000 Mbit/s	X	X								
Advantages	Application fields									
<ul style="list-style-type: none"> <li>• SFP used as connecting plug for extremely quick network connections</li> <li>• Standardized modules for network connections</li> </ul>	<ul style="list-style-type: none"> <li>• Railway applications</li> <li>• Industrial automation</li> <li>• Automotive industry</li> <li>• Wind power</li> </ul>									



## Accessories SFP modules

### SFP:

Type	SFP Fast Ethernet Transceiver 155 Mbit/s MM	SFP Fast Ethernet Transceiver 155 Mbit/s SM	SFP Gigabit Ethernet Transceiver 1.25 Gbit/s MM	SFP Gigabit Ethernet Transceiver 1.25 Gbit/s SM
Wave length	1310 nm	1310 nm	850 nm	1310 nm
Mode	Multimode	Singlemode	Multimode	Singlemode
Fiber	50 / 125 $\mu$ m or 62.5 / 125 $\mu$ m	9 / 125 $\mu$ m	50 / 125 $\mu$ m or 62.5 / 125 $\mu$ m	9 / 125 $\mu$ m
Max. cable length*	2 km	15 km	550 m (50 / 125) 275 m (62.5 / 125)	10 km
Connector	LC connector duplex	LC connector duplex	LC connector duplex	LC connector duplex
Optical budget	min. 8.2 dB	min. 8.2 dB	min. 9 dB	min. 9 dB
Data rate	155 Mbit/s	155 Mbit/s	1250 Mbit/s	1250 Mbit/s

\* Typical cable length depending on attenuation of each specific application.

Identification	Part number	Drawing	Dimensions in mm
----------------	-------------	---------	------------------

### SFP modules

SFP Fast Ethernet Transceiver 155 Mbit/s MM	20 76 000 0300	
SFP Fast Ethernet Transceiver 155 Mbit/s SM	20 76 020 0300	
SFP Gigabit Ethernet Transceiver 1.25 Gbit/s MM	20 76 010 0300	
SFP Gigabit Ethernet Transceiver 1.25 Gbit/s SM	20 76 030 0300	
other types on request		

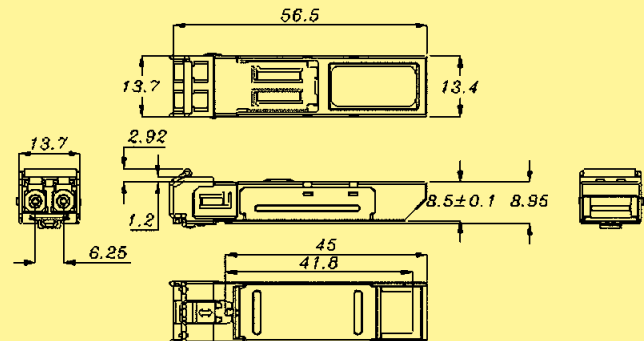



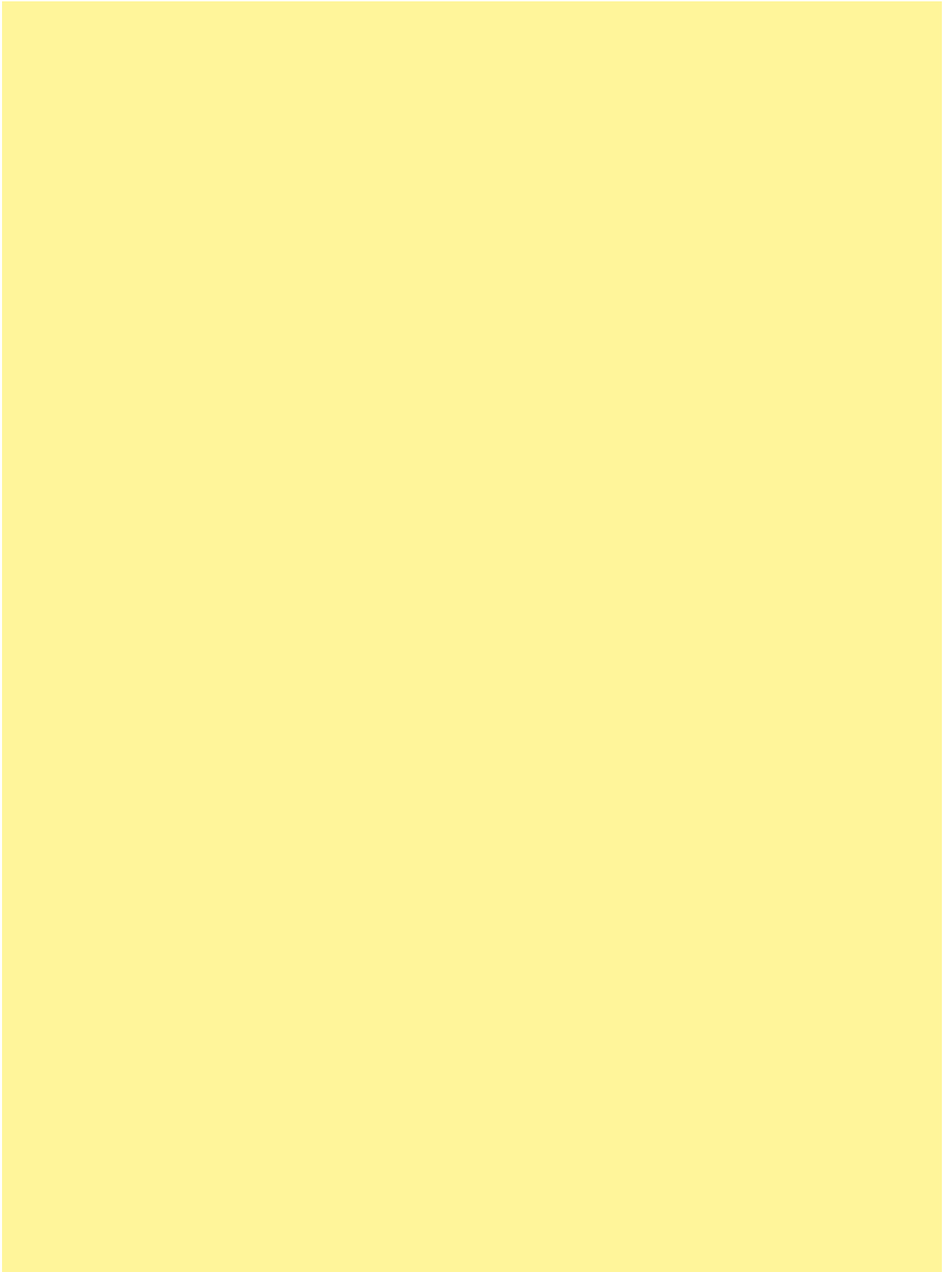

CONTENTS	PAGE
F.O. cables - General	90
F.O. cables with POF	91
F.O. cables with glass-fibre	92

## Description

The components offered by HARTING in the field of fibre optical data transmission are suitable in combination with different types of FOC. With view to the optical transmission characteristics we differentiate between the following types of fibre:

### Cables with Multimode-Gradient-Fibres (GI-Fibres)

- Suitable for transmission distances up to approx. 2 km (850 nm), approx. 5 km (1300 nm)
- Typical POF-connector termination: adhesive technique
- Typical wave length: 850/1300 nm

### Cable with HCS-Step-Index-Fibres (HCS<sup>® 1)</sup>-Fibres)

- Suitable for transmission distances up to approx. 2 km (850 nm), approx. 400 m (660 nm)
- Typical POF-connector termination: Crimp termination
- Typical wave length: 660/850 nm

### Cable with Plastic-Optical-Fibres (POF<sup>2)</sup>)

- Suitable for transmission distances up to approx. 100 m
- Typical POF-connector termination: Crimp termination, or HARTING quick assembly technique, no special tool necessary
- Typical wave length: 660 nm

## Fibre Types (typical characteristics)

	Plastic-Optical Fibre POF <sup>2)</sup>	Optical Fibre HCS <sup>® 1)</sup>	Glass-Optical Fibre	
			GI	GI
Fibre type	SI	SI	GI	GI
Core / jacket Ø	980 / 1000 µm	200 / 300 µm	62.5 / 125 µm	50 / 125 µm
Attenuation coefficient				
at 660 nm	200	10	-	
at 850 nm	2000	8	≤ 3.5	≤ 3.0
at 1350 nm	-	-	≤ 0,80	≤ 0,70
typ. wave length	660 nm	660 / 850 nm	850 / 1300 nm	850 / 1300 nm
Bandwidth MHz*km				
at 660 nm	10	-	-	-
at 850 nm	-	≥ 17	≥ 200	≥ 400

## Cable Plastic Materials

Material designation	Polymers (LowSmoke ZeroHalogen)	Polyvinylchloride	Polyethylene	Polyurethane	Polyamide	
Abbreviation	LSOH	PVC	PE	PUR	PA	
Halogen free	yes	no	yes	yes	yes	
Fire behaviour	self-extinguishing	self-extinguishing	combustible	self-extinguishing	combustible	
Resi- stance	to UV radiation	fair - good	fair	good	fair - good	good
	to oil	poor	fair	fair	fair - good	good
	with hydrolysis	good	good	good	poor - fair	fair
Abrasion resistance	good	fair	good	excellent	good	
Mechanical resistance	good	fair	good	good	good	



F.O. cables with polymer fibres (POF<sup>1)</sup>)  
 for internal and external applications  
 SI-fibre with 980 µm PMMA-core;  
 easy mechanical crimp technology

Identification	Part number	Drawing	Dimensions in mm
<b>F.O. cable POF<sup>1)</sup></b> <b>standard cable</b>		Technical Details: PMMA fibre: 980 / 1000 µm Temperature range: -40 °C ... +85 °C Bending radius min.: 30 mm	
Simplex Ø 2.2 mm PE fibre coating	20 20 001 1011		
Duplex Ø 2.2 x 4.4 mm PE fibre coating	20 20 001 1021		
<b>Special cable</b> <b>with strain relief</b> suitable for SERCOS applications		When ordering please specify cable length in metres.	
Simplex Ø 6.0 mm PE fibre coating PUR cable coating	20 21 001 1011		
Simplex Ø 3.6 mm PE fibre coating PUR cable coating	20 21 001 1012		
Duplex Ø 2.2 x 4.4 mm PE fibre coating	20 21 001 1021		
<b>Hybrid cable</b> geeignet für DESINA®-Applikationen			
PUR cable coating 2x POF <sup>1)</sup> PA fibre coating 4x 1.5 mm <sup>2</sup> 300 V / 300 V Ø 10.6 mm	20 23 041 1023		

<sup>1)</sup> POF = Polymer Optical Fibre

F.O. cables with glass-fibre  
for internal and external applications  
GI-fibre  
easy mechanical crimp technology





Identification	Part number	Drawing	Dimensions in mm
<p>F.O. cable glass-fibre standard cable</p> <p>Length*:                      10 m    <b>33 58 751 0100 001</b>    20 m    <b>33 58 751 0200 001</b>    100 m   <b>33 58 751 1000 001</b></p>			<p>PUR Mantel 2 fibres Multimode Outer diameter:            62.5 µm    7.0 mm Min. bending radius:   Installation                10.5 cm   Operating                    7.0 cm</p>
<p>F.O. cable, hybride 2x G50/125 + 3x 2.5 mm<sup>2</sup></p> <p>Length*:                      10 m    <b>33 57 851 0100 002</b>    20 m    <b>33 57 851 0200 002</b>    500 m   <b>33 57 851 5000 002</b></p>			<p>PVC Mantel Outer diameter (AD):        12.6 mm Min. bending radius:   singular                      5 x AD   repeated                     10 x AD</p>

\* other lengths on request

CONTENTS	PAGE
Tool kits	95
Handheld Tools	96
Accessories	97

## Description

The tools of the HARTING F.O. tool kit are suitable for the installation of F.O. connectors in site conditions. Detailed instructions for assembling the different connector types are included.

Identification	Part number	Drawing	Dimensions in mm
Tool kit POF <sup>1)</sup> without optical measuring device	20 99 000 3016		<p>Depth            360 mm Width            470 mm Height            170 mm</p> <p>Tool kit for F.O. connector assembly to all POF<sup>1)</sup> cables, without optical measuring instruments.</p>
Tool kit POF <sup>1)</sup> with optical measuring device	20 99 000 3013		<p>Tool kit for F.O. connector assembly and control of the F.O. transmission links for 1 mm polymer-optical fibres (POF<sup>1)</sup>).</p> <p>When applying these tools, F.O. connector types F-SMA, FH-ST and R 15 can be assembled without adhesive and grinding. The measuring instruments are easy to handle and suitable for service and maintenance. The tool kit contains a complete set of tools and test equipment.</p>
F.O. kit measuring instruments	20 99 000 3014		<p>Suitable cables are included in the delivery range.</p>
Tool kit GI fibre	20 99 000 3015		<p>Depth            360 mm Width            470 mm Height            170 mm</p> <p>Tool kit for connector mounting of glass fibres, using adhesive e.g.: GI 50/125 µm.</p>

<sup>1)</sup> POF = Polymer Optical Fibre



Identification	Part number	Drawing	Dimensions in mm
<b>HARTING Crimping tool</b> for F.O. connector (glass fibre) SW 4.3 mm SW 3.8 mm SW 4.95 mm	20 99 000 1031	 For crimping the strain relief to the connector F.O. cable for glass fibre	
<b>HARTING Crimping tool</b> for F.O. connector (POF <sup>1)</sup> fibre) SW 6.95 mm SW 4.95 mm SW 3.0 mm	20 99 000 1033	 For crimping the strain relief to the connector F.O. cable for POF <sup>1)</sup> fibre	
<b>Vierkerbcrimpzange</b> for following 1 mm POF <sup>1)</sup> contacts Han D <sup>®</sup> , Han E <sup>®</sup> DIN 41 626 Ferrule F-SMA, -ST	20 99 000 1035	 This tool is only usable for F.O. contacts. Crimping tools for electrical contacts see catalogue "Industrial Connectors Han <sup>®</sup> ".	
<b>Crimping tool Han-Brid<sup>®</sup></b> for electrical and optical crimp contacts	09 99 000 0362		
<b>Cutting tool</b> 2.2 mm POF <sup>1)</sup>	20 99 000 1049	Delivery range 10 pieces / set	
<b>Fibre stripper</b> 1 mm POF <sup>1)</sup>	0.3 mm <b>20 99 000 1041</b> 1 mm <b>20 99 000 1045</b> 0.18 / 0.3 mm <b>20 99 000 1046</b>		

Identification	Part number	Drawing	Dimensions in mm
Polishing tool for F.O. connectors: F-SMA	20 99 000 1091		
DIN 41 626	20 99 000 1092		
POF <sup>1)</sup> cable Ø 2.2 mm	20 99 000 1093		
F-TNC	20 99 000 1094		
F-ST	20 99 000 1095		
Ferrule SC	20 99 000 1096		
Polishing kit Versatile Link	20 80 001 9914	Delivery range: Duplex polishing tool 2x polish paper	
Epoxy adhesive glass fibre	20 80 001 9902	2 ml EPO-TEK 360 with hardener (10:1), 4 g foil pack	
Polishing paper  for POF <sup>1)</sup> grain size 1000 for GI 9 µ-grain size for GI 1 µ-grain size	20 80 001 9911 20 80 001 9912 20 80 001 9913	Delivery range: Each part number ordered comprises 5 pieces.	

<sup>1)</sup> POF = Polymer Optical Fibre

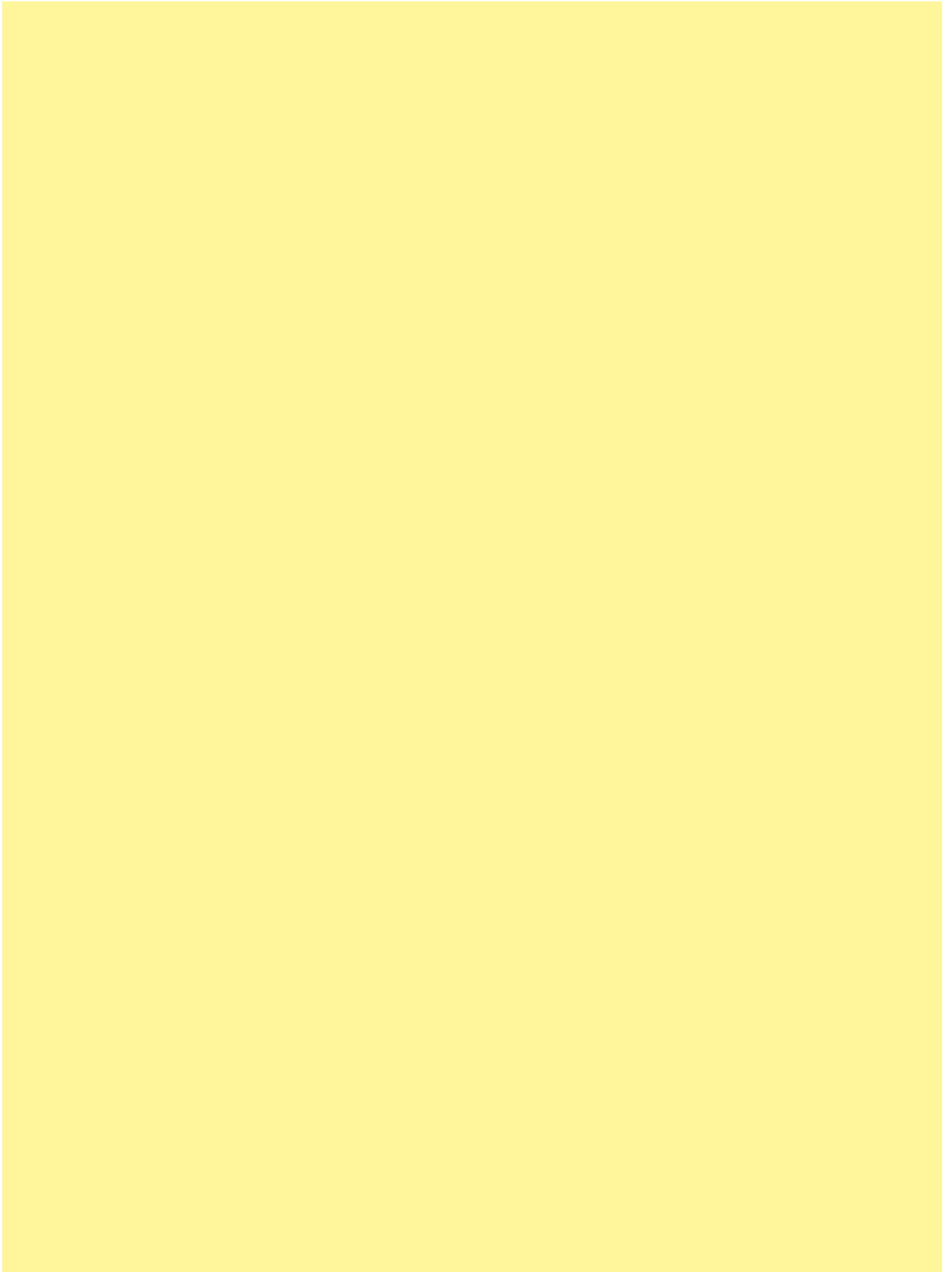

# List of part numbers



Part number	Page	Part number	Page	Part number	Page	Part number	Page	Part number	Page
09 12 004 2601	36	09 21 007 3131	25	09 35 002 5401	67	09 57 508 0500 000	72	20 10 003 3211	20
09 12 004 2603	36			09 35 002 5402	67	09 57 508 0501 000	72	20 10 003 4811	21
09 12 004 2606	36	09 21 015 3001	25	09 35 002 5411	66	09 57 508 0510 000	72		
09 12 004 2611	35	09 21 015 3101	25	09 35 002 5411	69	09 57 508 0511 000	72		
09 12 004 2701	36			09 35 002 5412	66			20 10 007 3211	19
09 12 004 2711	35			09 35 002 5412	69	09 57 568 0500 000	72		
09 12 004 2713	35	09 21 025 3001	25			09 57 568 0501 000	72	20 10 016 3211	19
09 12 004 2716	35	09 21 025 3101	25	09 35 241 0401	69	09 57 568 0510 000	72		
09 12 004 3001	36			09 35 241 0402	69	09 57 568 0511 000	72		
09 12 004 3003	36	09 21 040 3001	25	09 35 241 0421	66			20 10 125 1212	77
09 12 004 3006	36	09 21 040 3101	25	09 35 241 0422	66			20 10 125 2212	77
09 12 004 3011	35							20 10 125 4212	30
09 12 004 3101	36			09 35 242 0313	68	09 99 000 0362	96	20 10 125 4212	43
09 12 004 3111	35	09 21 064 3001	25					20 10 125 4212	45
09 12 004 3113	35	09 21 064 3101	25					20 10 125 4222	30
09 12 004 3116	35							20 10 125 4222	43
09 14 004 4501	30			09 36 008 3001	25			20 10 125 4222	45
09 14 004 4501	43	09 32 010 3001	27	09 36 008 3101	25	20 10 001 1211	76	20 10 125 5211	29
09 14 004 4512	30	09 32 010 3101	27			20 10 001 1212	75	20 10 125 5211	33
09 14 004 4512	43					20 10 001 1215	75	20 10 125 5211	47
09 14 004 4701	29					20 10 001 1217	75	20 10 125 5211	66
09 14 004 4701	47	09 32 012 3001	28	09 38 032 3001	28	20 10 001 1221	76	20 10 125 5211	68
09 14 004 4711	29	09 32 012 3101	28	09 38 032 3101	28	20 10 001 1241	76	20 10 125 5211	69
09 14 004 4711	47					20 10 001 2211	76	20 10 125 5211	77
		09 32 018 3001	27			20 10 001 2212	75		
09 14 012 3001	26	09 32 018 3101	27	09 38 042 3001	28	20 10 001 3211	26	20 10 230 1212	77
09 14 012 3001	39			09 38 042 3101	28	20 10 001 3211	28	20 10 230 2212	77
09 14 012 3101	26	09 32 032 3001	27			20 10 001 3211	39	20 10 230 4211	30
09 14 012 3101	39	09 32 032 3011	27			20 10 001 3211	41	20 10 230 4211	43
09 14 012 4501	30	09 32 032 3101	27	09 45 845 0003	65	20 10 001 3212	25	20 10 230 4211	45
09 14 012 4501	45	09 32 032 3111	27	09 45 845 0009 024	65	20 10 001 3213	25	20 10 230 4221	30
09 14 012 4512	30			09 45 845 0009	65	20 10 001 3221	26	20 10 230 4221	43
09 14 012 4512	45			09 45 845 0010	65	20 10 001 3221	28	20 10 230 4221	45
		09 32 046 3001	27	09 45 845 0010	65	20 10 001 3221	39	20 10 230 4221	45
09 14 017 3001	26	09 32 046 3011	27	09 45 845 0011 024	65	20 10 001 3221	41	20 10 230 5211	29
09 14 017 3001	41	09 32 046 3101	27	09 45 845 0013	65	20 10 001 3222	25	20 10 230 5211	33
09 14 017 3101	26	09 32 046 3111	27	09 45 845 0014	65	20 10 001 3232	17	20 10 230 5211	47
09 14 017 3101	41			09 45 845 0014	65	20 10 001 3232	20	20 10 230 5211	66
				09 45 845 0015	65	20 10 001 3311	27	20 10 230 5211	68
				09 45 845 0020	65	20 10 001 3321	27	20 10 230 5211	69
		09 33 006 2602	27			20 10 001 3321	27	20 10 230 7111	77
09 16 024 3001	26	09 33 006 2702	27	09 57 000 0000 200	57	20 10 001 4211	30		
09 16 024 3101	26					20 10 001 4211	30		
		09 33 010 2602	27	09 57 400 0001 000	64	20 10 001 4211	43		
09 16 042 3001	26	09 33 010 2702	27	09 57 400 0002 000	64	20 10 001 4211	45		
09 16 042 3101	26			09 57 400 0003 000	64	20 10 001 4221	30	20 20 001 1011	91
		09 33 016 2602	27	09 57 400 0004 000	64	20 10 001 4221	43	20 20 001 1021	91
09 16 072 3001	26	09 33 016 2612	27			20 10 001 4221	45	20 21 001 1011	91
09 16 072 3011	26	09 33 016 2702	27	09 57 407 0001 000	71	20 10 001 4231	30	20 21 001 1012	91
09 16 072 3101	26	09 33 016 2712	27	09 57 407 0002 000	71	20 10 001 4231	43	20 21 001 1021	91
09 16 072 3111	26					20 10 001 4231	45		
		09 33 024 2602	27			20 10 001 4232	30		
09 16 108 3001	26	09 33 024 2612	27	09 57 441 0500 000	63	20 10 001 4232	43		
09 16 108 3011	26	09 33 024 2702	27	09 57 441 0501 000	63	20 10 001 4232	45	20 23 041 1023	91
09 16 108 3101	26	09 33 024 2712	27			20 10 001 5211	29		
09 16 108 3111	26					20 10 001 5211	33		
						20 10 001 5211	33		
						20 10 001 5211	47	20 40 000 1112	13
						20 10 001 5211	76	20 40 000 1122	13
						20 10 001 5217	29		
						20 10 001 5217	33		
						20 10 001 5217	47	20 40 003 3821	20
						20 10 001 5217	66	20 40 003 3822	20
						20 10 001 5217	68	20 40 003 4813	21
						20 10 001 5217	69	20 40 003 4823	21
						20 10 001 5217	75		
						20 10 001 5217	75		
09 20 004 4701	29	09 35 000 9913	70	09 57 467 0004 000	71	20 10 001 5218	75		
09 20 004 4701	33	09 35 000 9914	70	09 57 467 0005 000	71	20 10 001 6211	76	20 40 007 3821	19
09 20 004 4711	29					20 10 001 6233	76	20 40 007 3841	19
09 20 004 4711	33	09 35 002 0303	67	09 57 468 0500 000	63				
		09 35 002 4002	66	09 57 468 0501 000	63				
		09 35 002 4002	68						
		09 35 002 4002	69	09 57 474 0500 001	57	20 10 001 7111	76		
09 21 007 3031	25					20 10 001 7112	76	20 40 016 3823	19

# List of part numbers



Part number	Page	Part number	Page	Part number	Page	Part number	Page	Part number	Page
20 50 000 1111	13	33 53 111 0010 001	58	33 54 451 0100 007	56	33 57 211 0405 001	62	33 58 211 1000 001	54
20 50 000 1121	13	33 53 111 0010 002	58	33 54 451 0100 010	56	33 57 211 0405 002	62	33 58 211 1000 002	50
20 50 000 2112	15	33 53 111 0020 001	58	33 54 451 0100 012	56	33 57 211 0405 003	61	33 58 211 1000 004	52
20 50 000 2116	15	33 53 111 0020 002	58	33 54 451 0150 007	56	33 57 211 0405 004	61		
20 50 000 2119	15	33 53 111 0050 001	58	33 54 451 0150 010	56	33 57 211 0505 001	62	33 58 231 0010 015	51
20 50 000 2222	15	33 53 111 0050 002	58	33 54 451 0150 012	56	33 57 211 0505 002	62	33 58 231 0010 016	55
20 50 000 2226	15	33 53 111 0100 001	58	33 54 451 0200 007	56	33 57 211 0505 003	61	33 58 231 0010 017	53
20 50 000 2229	15	33 53 111 0100 002	58	33 54 451 0200 010	56	33 57 211 0505 004	61	33 58 231 0050 015	51
		33 53 111 0200 001	58	33 54 451 0200 012	56	33 57 211 1005 001	62	33 58 231 0050 016	55
		33 53 111 0200 002	58			33 57 211 1005 002	62	33 58 231 0050 017	53
				33 54 751 0100 001	59	33 57 211 1005 003	61	33 58 231 0100 015	51
20 66 009 3811	17			33 54 751 0100 002	60	33 57 211 1005 004	61	33 58 231 0100 016	55
20 66 009 3812	17	33 53 211 0010 001	58					33 58 231 0100 017	53
20 66 009 3813	17	33 53 211 0010 002	58	33 54 751 0200 001	59				
		33 53 211 0020 001	58	33 54 751 0200 002	60	33 57 851 0100 002	62	33 58 231 0200 015	51
		33 53 211 0020 002	58			33 57 851 0100 002	92	33 58 231 0200 016	55
20 67 009 3811	17	33 53 211 0050 001	58	33 54 751 1000 001	59	33 57 851 0100 003	61	33 58 231 0200 017	53
		33 53 211 0050 002	58	33 54 751 1000 002	60				
		33 53 211 0100 001	58			33 57 851 0200 002	62	33 58 231 0400 015	51
		33 53 211 0100 002	58			33 57 851 0200 002	92	33 58 231 0400 016	55
20 76 000 0300	87					33 57 851 0200 003	61	33 58 231 0400 017	53
		33 53 211 0200 001	58						
20 76 010 0300	87	33 53 211 0200 002	58	33 57 111 0015 001	62	33 57 851 5000 002	62	33 58 231 0500 015	51
				33 57 111 0015 002	62	33 57 851 5000 002	92	33 58 231 0500 016	55
				33 57 111 0015 003	61	33 57 851 5000 003	61	33 58 231 0500 017	53
				33 57 111 0015 004	61				
20 76 020 0300	87			33 57 111 0055 001	62			33 58 231 0600 015	51
				33 57 111 0055 002	62			33 58 231 0600 016	55
				33 57 111 0055 003	61			33 58 231 0600 017	53
				33 57 111 0055 004	61				
20 76 030 0300	87	33 54 111 0010 001	59			33 58 111 0010 001	54	33 58 231 1000 015	51
		33 54 111 0010 002	60			33 58 111 0010 002	50	33 58 231 1000 016	55
		33 54 111 0050 001	59			33 58 111 0010 004	52	33 58 231 1000 017	53
		33 54 111 0050 002	60			33 58 111 0050 001	54	33 58 231 1000 015	51
20 76 102 3100	84			33 57 111 0105 001	62	33 58 111 0050 001	54	33 58 231 1000 016	55
20 76 102 3101	85	33 54 111 0100 001	59	33 57 111 0105 002	62	33 58 111 0050 002	50	33 58 231 1000 017	53
		33 54 111 0100 002	60	33 57 111 0105 003	61	33 58 111 0050 004	52	33 58 231 3000 015	51
				33 57 111 0105 004	61	33 58 111 0100 001	54	33 58 231 3000 016	55
				33 57 111 0205 001	62	33 58 111 0100 002	50	33 58 231 3000 017	53
				33 57 111 0205 002	62	33 58 111 0100 004	52		
20 80 000 1021	77	33 54 111 0400 001	59	33 57 111 0205 003	61	33 58 111 0200 001	54	33 58 751 0100 001	54
20 80 000 1065	75	33 54 111 0400 002	60	33 57 111 0205 004	61	33 58 111 0200 002	50	33 58 751 0100 001	55
20 80 000 1066	75					33 58 111 0200 004	52	33 58 751 0100 001	92
20 80 000 1071	77	33 54 111 0500 001	59					33 58 751 0100 002	50
20 80 000 1072	13	33 54 111 0500 002	60	33 57 111 0405 001	62	33 58 111 0400 001	54	33 58 751 0100 002	51
				33 57 111 0405 002	62	33 58 111 0400 002	50	33 58 751 0100 003	52
20 80 001 9902	97	33 54 111 1000 001	59	33 57 111 0405 003	61	33 58 111 0400 004	52	33 58 751 0100 003	53
20 80 001 9911	70	33 54 111 1000 002	60	33 57 111 0405 004	61			33 58 751 0200 001	54
20 80 001 9911	97					33 58 111 0500 001	54	33 58 751 0200 001	55
20 80 001 9912	97	33 54 211 0010 001	59	33 57 111 0505 001	62	33 58 111 0500 002	50	33 58 751 0200 001	92
20 80 001 9912	97	33 54 211 0010 002	60	33 57 111 0505 002	62	33 58 111 0500 004	52	33 58 751 0200 002	50
20 80 001 9913	97	33 54 211 0050 001	59	33 57 111 0505 003	61	33 58 111 1000 001	54	33 58 751 0200 002	51
20 80 001 9914	97	33 54 211 0050 002	60	33 57 111 0505 004	61	33 58 111 1000 002	50	33 58 751 0200 003	52
						33 58 111 1000 004	52	33 58 751 0200 003	53
				33 57 111 1005 001	62				
				33 57 111 1005 002	62				
				33 57 111 1005 003	61				
				33 57 111 1005 004	61				
20 99 000 1031	96	33 54 211 0200 001	59			33 58 211 0010 001	54	33 58 751 1000 001	54
20 99 000 1033	96	33 54 211 0200 002	60			33 58 211 0010 002	50	33 58 751 1000 001	55
20 99 000 1035	96					33 58 211 0010 004	52	33 58 751 1000 001	92
20 99 000 1041	96	33 54 211 0400 001	59	33 57 211 0015 001	62	33 58 211 0050 001	54	33 58 751 1000 002	50
20 99 000 1045	96	33 54 211 0400 002	60	33 57 211 0015 002	62	33 58 211 0050 002	50	33 58 751 1000 002	51
20 99 000 1046	96			33 57 211 0015 003	61	33 58 211 0050 004	52	33 58 751 1000 003	52
20 99 000 1049	96	33 54 211 0500 001	59	33 57 211 0015 004	61			33 58 751 1000 003	53
20 99 000 1049	96	33 54 211 0500 002	60						
20 99 000 1091	97			33 57 211 0055 001	62	33 58 211 0100 001	54		
20 99 000 1092	97	33 54 211 1000 001	59	33 57 211 0055 002	62	33 58 211 0100 002	50		
20 99 000 1093	97	33 54 211 1000 002	60	33 57 211 0055 003	61	33 58 211 0100 004	52		
20 99 000 1094	97			33 57 211 0055 004	61				
20 99 000 1095	97					33 58 211 0200 001	54		
20 99 000 1096	97	33 54 451 0010 007	56	33 57 211 0105 001	62	33 58 211 0200 002	50		
20 99 000 1096	97	33 54 451 0010 010	56	33 57 211 0105 002	62	33 58 211 0200 004	52		
20 99 000 1099	70	33 54 451 0010 012	56	33 57 211 0105 003	61	33 58 211 0400 001	54		
20 99 000 3013	70	33 54 451 0020 007	56	33 57 211 0105 004	61	33 58 211 0400 002	50		
20 99 000 3013	95	33 54 451 0020 010	56			33 58 211 0400 004	52		
20 99 000 3014	95	33 54 451 0020 012	56	33 57 211 0205 001	62				
20 99 000 3015	95	33 54 451 0050 007	56	33 57 211 0205 002	62	33 58 211 0500 001	54		
20 99 000 3016	70	33 54 451 0050 010	56	33 57 211 0205 003	61	33 58 211 0500 002	50		
20 99 000 3016	95	33 54 451 0050 012	56	33 57 211 0205 004	61	33 58 211 0500 004	52		

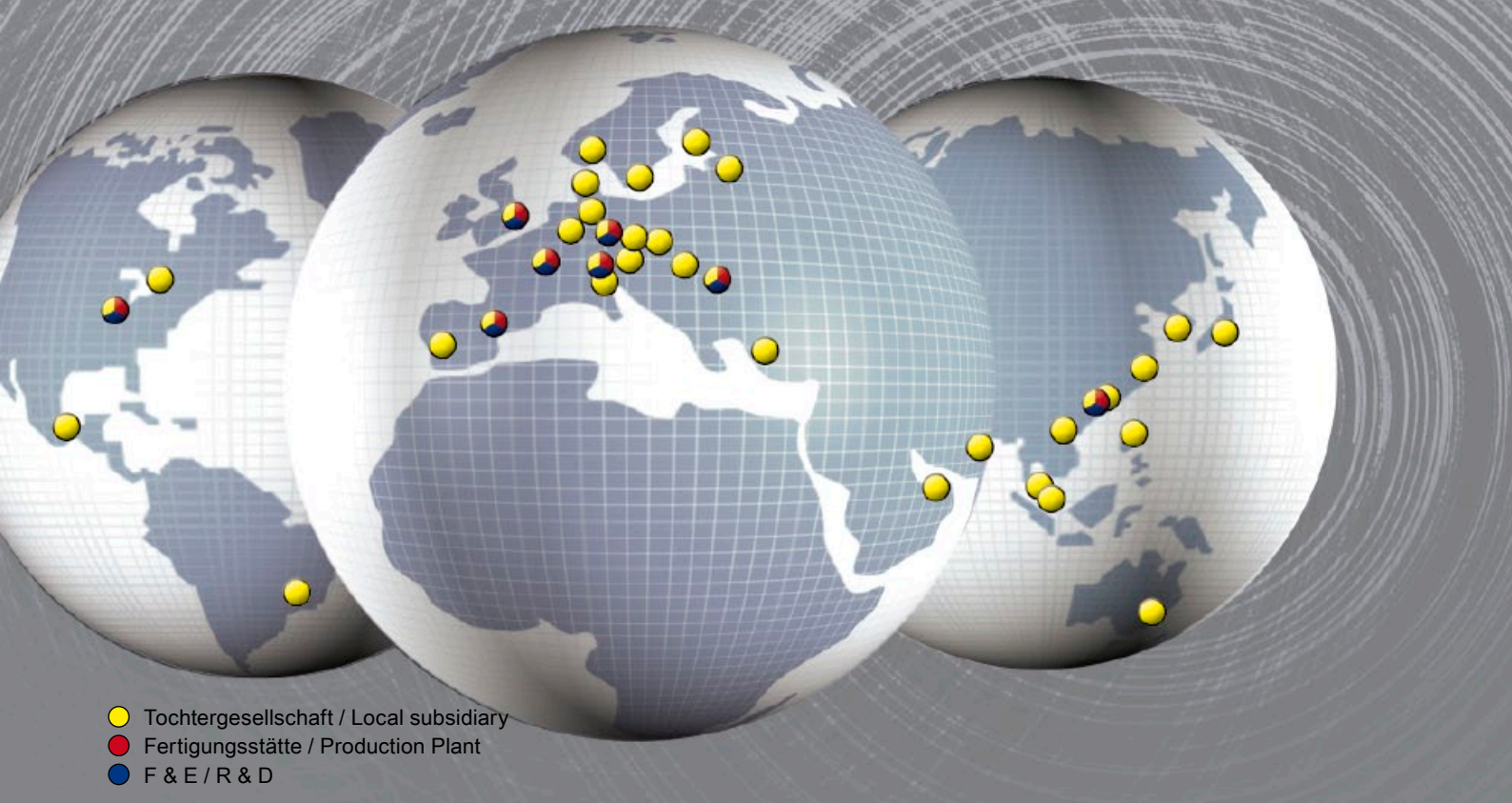

## Sales Network – worldwide



### Albania

see Eastern Europe

### Argentina

Condelectric S.A.  
 Hipólito Yrigoyen 2591, 1640 - Martínez  
 Buenos Aires – Argentina  
 Phone +54 11 4836 1053  
 Fax +54 11 4836 1053  
 comercial@condelectric.com.ar

### Armenia

see Eastern Europe

### Australia

HARTING Pty Ltd  
 Suite 11 / 2 Enterprise Drive  
 Bundoora 3083, AUS-Victoria  
 Phone +61 3 9466 7088  
 Fax +61 3 9466 7099  
 au@HARTING.com  
 www.HARTING.com.au

### Austria

HARTING Ges.m.b.H.  
 Deutschstraße 19, A-1230 Wien  
 Phone +431 6162121  
 Fax +431 6162121-21  
 at@HARTING.com  
 www.HARTING.at

### Azerbaijan

see Eastern Europe

### Bahrain

see United Arab Emirates

### Belarus

see Eastern Europe

### Belgium

HARTING N.V./S.A.  
 Z.3 Doornveld 23, B-1731 Zellik  
 Phone +32 2 466 0190  
 Fax +32 2 466 7855  
 be@HARTING.com  
 www.HARTING.be

### Bosnia and Herzegovina

see Eastern Europe

### Brazil

HARTING Ltda.  
 Rua Major Paladino 128; Prédio 11  
 CEP 05307-000 São Paulo  
 SP – Brazil  
 Phone +55 11 5035 0073  
 Fax +55 11 5034 4743  
 br@HARTING.com  
 www.HARTING.com.br

### Brunei

see Singapore

### Bulgaria

see Eastern Europe

### Canada

HARTING Canada Inc.  
 8455 Trans-Canada Hwy., Suite 202  
 St. Laurent, QC, H4S1Z1, Canada  
 Phone 855-659-6653  
 Fax 855-659-6654  
 info.ca@HARTING.com  
 www.HARTING.ca

### China

HARTING (Zhuhai) Manufacturing Co., Ltd.  
 Shanghai Branch  
 Room 3501-3503  
 No. 1 Hong Qiao Road, Grand Gateway I  
 Xu Hui District, Shanghai 200030, China  
 Phone +86 21 6386 2200,  
 Fax +86 21 6386 8636  
 cn@HARTING.com  
 www.HARTING.com.cn

### Croatia

see Eastern Europe

### Czech Republic

HARTING s.r.o.  
 Mlýnská 2, CZ-160 00 Praha 6  
 Phone +420 220 380 460  
 Fax +420 220 380 461  
 cz@HARTING.com  
 www.HARTING.cz



**Denmark**

HARTING ApS  
Hjulmagervej 4a  
DK - 7100 Vejle  
Phone +45 70 25 00 32  
Fax +45 75 80 64 99  
dk@HARTING.com  
www.HARTING.com

**Eastern Europe**

HARTING Eastern Europe GmbH  
Bamberger Straße 7  
D-01187 Dresden  
Phone +49 351 4361 760  
Fax +49 351 436 1770  
Eastern.Europe@HARTING.com  
www.HARTING.com

**Estonia**

see Eastern Europe

**Finland**

HARTING Oy  
Teknobulevardi 3-5  
FI-01530 Vantaa  
Phone +358 207 291 510  
Fax +358 207 291 511  
fi@HARTING.com  
www.HARTING.fi

**France**

HARTING France  
181 avenue des Nations, Paris Nord 2  
BP 66058 Tremblay en France  
F-95972 Roissy Charles de Gaulle  
Cédex  
Phone +33 1 4938 3400  
Fax +33 1 4863 2306  
fr@HARTING.com  
www.HARTING.fr

**Germany**

HARTING Deutschland GmbH & Co. KG  
P.O. Box 2451, D-32381 Minden  
Simeons carré 1, D-32427 Minden  
Phone +49 571 8896 0  
Fax +49 571 8896 282  
de@HARTING.com  
www.HARTING.de

**Georgia**

see Eastern Europe

**Great Britain**

HARTING Ltd., Caswell Road  
Brackmills Industrial Estate  
GB-Northampton, NN4 7PW  
Phone +44 1604 827 500  
Fax +44 1604 706 777  
gb@HARTING.com  
www.HARTING.co.uk

**Hong Kong**

HARTING (HK) Limited  
Regional Office Asia Pacific  
3512 Metroplaza Tower 1  
223 Hing Fong Road  
Kwai Fong, N. T., Hong Kong  
Phone +852 2423 7338  
Fax +852 2480 4378  
ap@HARTING.com  
www.HARTING.com.hk

**Hungary**

HARTING Magyarország Kft.  
Fehérvári út 89-95, H-1119 Budapest  
Phone +36 1 205 34 64  
Fax +36 1 205 34 65  
hu@HARTING.com  
www.HARTING.hu

**Iceland**

Smith & Norland, Nóatún 4  
IS – 105 Reykjavík  
Phone +354 520 3000  
Fax +354 520 3011  
olaf@sminor.is, www.sminor.is

**India**

HARTING India Private Limited  
No. D, 4th Floor, 'Doshi Towers'  
No. 156 Poonamallee High Road  
Kilpauk, Chennai 600 010  
Tamil Nadu, India  
Phone +91 44 435604 15 / 416  
Fax +91 44 435604 17  
in@HARTING.com  
www.HARTING.in

**Indonesia**

see Malaysia

**Israel**

COMTEL  
Israel Electronic Solutions Ltd.  
Bet Hapamon, 20 Hataas st.  
P.O.Box 66  
Kefar-Saba 44425  
Phone +972-9-7677240  
Fax +972-9-7677243  
sales@comtel.co.il  
www.comtel.co.il

**Italy**

HARTING SpA  
Via Dell' Industria 7  
I-20090 Vimodrone (Milano)  
Phone +39 02 250801  
Fax +39 02 2650 597  
it@HARTING.com  
www.HARTING.it

**Japan**

HARTING K. K.  
Yusen Shin-Yokohama 1 Chome Bldg., 2F  
1-7-9, Shin-Yokohama, Kohoku  
Yokohama 222-0033 Japan  
Phone +81 45 476 3456  
Fax +81 45 476 3466  
jp@HARTING.com  
www.HARTING.co.jp

**Jordan**

see United Arab Emirates

**Kazakhstan**

see Eastern Europe

**Kirghizia**

see Eastern Europe

**Korea (South)**

HARTING Korea Limited  
#308 Yatap Leaders Building  
342-1, Yatap-dong, Bundang-gu  
Sungnam-City, Kyunggi-do  
463-828, Republic of Korea  
Phone +82 31 781 4615  
Fax +82 31 781 4616  
kr@HARTING.com  
www.HARTING.co.kr

**Kosovo**

see Eastern Europe

**Kuwait**

see United Arab Emirates

**Latvia**

see Eastern Europe

**Lithuania**

see Eastern Europe

**Macedonia**

see Eastern Europe

**Malaysia (Office)**

HARTING Singapore Pte Ltd  
Malaysia Branch  
11-02 Menara Amcorp  
Jln. Persiaran Barat  
46200 PJ, Sel. D. E., Malaysia  
Phone +60 3 / 7955 6173  
Fax +60 3 / 7955 5126  
sg@HARTING.com

**Montenegro**

see Eastern Europe

**Netherlands**

HARTING B.V.  
Larenweg 44  
NL-5234 KA ,s-Hertogenbosch  
Postbus 3526  
NL-5203 DM ,s-Hertogenbosch  
Phone +31 736 410 404  
Fax +31 736 440 699  
nl@HARTING.com  
www.HARTINGbv.nl

**New Zealand**

see Australia

**Norway**

HARTING A/S  
Østensjøveien 36, N-0667 Oslo  
Phone +47 22 700 555  
Fax +47 22 700 570  
no@HARTING.com  
www.HARTING.no

## Oman

see United Arab Emirates

## Pakistan

see United Arab Emirates

## Philippines

see Malaysia

## Poland

HARTING Polska Sp. z o. o.  
ul. Duńska 9  
PL- 54-427 Wrocław  
Phone +48 71 352 81 71  
Fax +48 71 350 42 13  
pl@HARTING.com  
www.HARTING.pl

## Portugal

HARTING Iberia, S. A.  
Avda. Josep Tarradellas 20-30 4º 6a  
E-08029 Barcelona  
Phone +351 219 673 177  
Fax +351 219 678 457  
es@HARTING.com  
www.HARTING.es/pt

## Qatar

see United Arab Emirates

## Republic of Moldova

see Eastern Europe

## Romania

HARTING Romania SCS  
Europa Unita str. 21  
550018-Sibiu, Romania  
Phone +40 369-102 671  
Fax +40 369-102 622  
ro@HARTING.com  
www.HARTING.com

## Russia

HARTING ZAO  
Maliy Sampsoniyevsky prospect 2A  
194044 Saint Petersburg, Russia  
Phone +7 812 327 6477  
Fax +7 812 327 6478  
ru@HARTING.com  
www.HARTING.ru

## Saudi Arabia

see United Arab Emirates

## Serbia

see Eastern Europe

## Singapore

HARTING Singapore Pte Ltd.  
25 International Business Park  
#04-108 German Centre  
Singapore 609916  
Phone +65 6225 5285  
Fax +65 6225 9947  
sg@HARTING.com  
www.HARTING.sg

## Slovakia

HARTING s.r.o.  
Sales office Slovakia  
J. Simora 5, SK - 940 52 Nové Zámky  
Phone +421 356-493 993  
Fax +421 356-402 114  
sk@HARTING.com  
www.HARTING.sk

## Slovenia

see Eastern Europe

## South Africa

HellermannTyton Pty Ltd.  
Private Bag X158 Rivonia 2128  
34 Milky Way Avenue  
Linbro Business Park 2065  
Johannesburg  
Phone +27(0)11879-6600  
Fax +27(0)11879-6606  
sales.jhb@hellermann.co.za

## Spain

HARTING Iberia S.A.  
Avda. Josep Tarradellas 20-30 4º 6a  
E-08029 Barcelona  
Phone +34 93 363 84 75  
Fax +34 93 419 95 85  
es@HARTING.com  
www.HARTING.es

## Sweden

HARTING AB  
Gustavslundsvägen 141 B 4tr  
S-167 51 Bromma  
Phone +46 8 445 7171  
Fax +46 8 445 7170  
se@HARTING.com  
www.HARTING.se

## Switzerland

HARTING AG  
Industriestrasse 26  
CH-8604 Volketswil  
Phone +41 44 908 20 60  
Fax +41 44 908 20 69  
ch@HARTING.com  
www.HARTING.ch

## Taiwan

HARTING Taiwan Ltd.  
Room 1, 5/F  
495 GuangFu South Road  
RC-110 Taipei, Taiwan  
Phone +886 2 2758 6177  
Fax +886 2 2758 7177  
tw@HARTING.com  
www.HARTING.com.tw

## Tajikistan

see Eastern Europe

## Thailand

see Malaysia

## Turkey

HARTING TURKEI Elektronik Ltd. Şti.  
Barbaros Mah. Dereboyu Cad.  
Fesleğen Sok.  
Uphill Towers, A-1b Kat:8 D:45  
34746 Ataşehir, İstanbul  
Phone +90 216 688 81 00  
Fax +90 216 688 81 01  
tr@HARTING.com  
www.HARTING.com.tr

## Turkmenistan

see Eastern Europe

## Ukraine

see Eastern Europe

## United Arab Emirates

HARTING Middle East FZ-LLC  
Knowledge Village, Block 2A, Office F72  
P.O. Box 454372, Dubai  
United Arab Emirates  
Phone +971 4 453 9737  
Fax +971 4 439 0339  
uae@HARTING.com  
www.HARTING.ae

## USA

HARTING Inc. of North America  
1370 Bowes Road  
USA-Elgin, Illinois 60123  
Phone +1 (877) 741-1500 (toll free)  
Fax +1 (866) 278-0307 (Inside Sales)  
us@HARTING.com  
www.HARTING-USA.com

## Uzbekistan

see Eastern Europe

## Vietnam

see Singapore

## Distributors – worldwide



Farnell:  
www.farnell.com

RS Components:  
www.rs-components.com

Mouser Electronics:  
www.mouser.com

Digi-Key Corporation:  
www.digikey.com

## Other countries and general contact



HARTING Electric GmbH & Co. KG  
P.O. Box 1473, D-32328 Espelkamp  
Phone +49 5772 47-97100  
Fax +49 5772 47-495  
electric@HARTING.com





**Pushing Performance**

**HARTING Technology Group**

Marienwerderstr. 3, 32339 Espelkamp – Germany

P.O. Box 11 33, 32325 Espelkamp – Germany

Phone +49 5772 47-0, Fax +49 5772 47-400

[info@HARTING.com](mailto:info@HARTING.com)

[www.HARTING.com](http://www.HARTING.com)