

Standard Female Connectors picoMAX® 5.0

With gripping plate and sliding connector release Pin spacing: 5 mm / 0.197 in 0.2 - 2.5 mm ² AWG 24 - 12 320 V/4 kV/2 16 A 300 V/15 A		Types of assembly with male headers/connectors
--	--	---

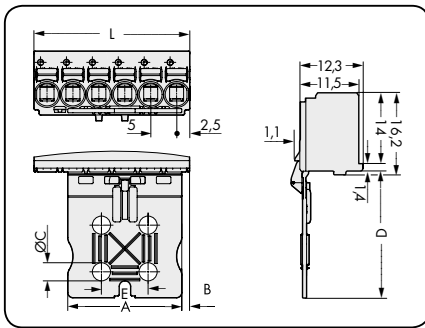

L = pole no. x pin spacing

Pole No.	Item No.	Pack. Unit
Female connector with gripping plate and sliding connector release, light gray		
2	2092-1102/002-000	100
3	2092-1103/002-000	100
4	2092-1104/002-000	100
5	2092-1105/002-000	50
6	2092-1106/002-000	50
8	2092-1108/002-000	50
10	2092-1110/002-000	50
12	2092-1112/002-000	50

Gripping plate dimensions (in mm):

Pole No.	A	B	C	D	E
2	7	1.5	-	20	-
3	12	1.5	-	20	-
4	12	1.5	-	20	-
5	22	1.5	3.5	25	9
6	22	1.5	3.5	25	9
8	22	6.5	3.5	25	9
10	42	1.5	5.0	35	19
12	42	6.5	5.0	35	19



Header with straight solder pins





Header with angled solder pins





Standard connector





Panel feedthrough connector

Outside 

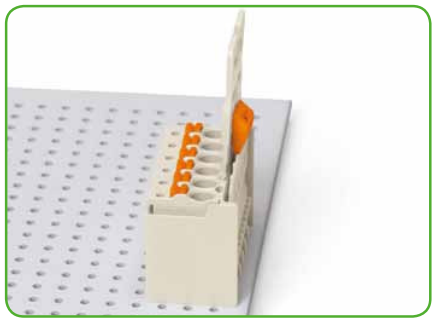

Inside 



Male header mated to a female connector with gripping plate and sliding connector release.

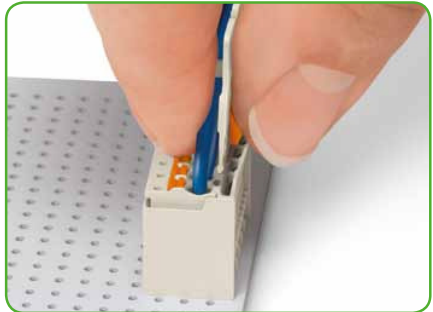

Push down sliding connector release (gripping plate) to open the locking latch.

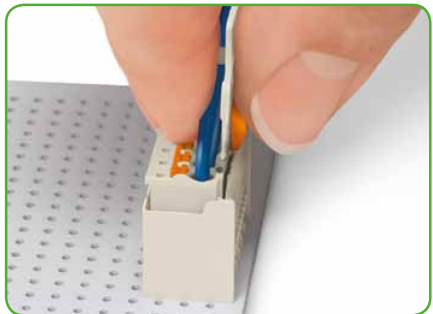

Pull out female connector with gripping plate from male header.

5.0

Standard Female Connectors

picoMAX® 5.0

28

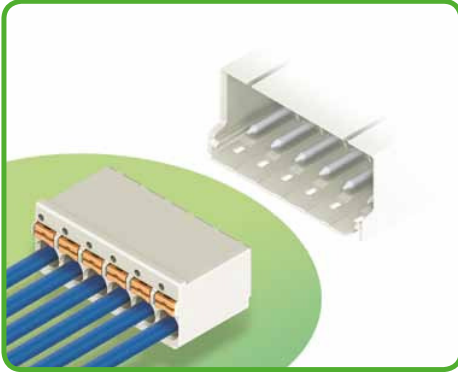

- Universal connection for all conductor types
- Simple, push-in termination of solid and ferruled conductors
- Ability to wire while mated or unmated
- Testing port parallel to conductor entry – tip contact
- Integrated locking latches prevent accidental disconnection

Technical data:

Pin Spacing	5 mm 0.197 in		
Ratings per	IEC/EN 60664-1		
Overtoltage category	III	III	II
Pollution degree	3	2	2
Rated voltage	250 V	320 V	630 V
Rated surge voltage	4 kV	4 kV	4 kV
Nominal current	16 A	16 A	16 A
Approvals per	UL/CSA*		
Use group UL 1059	B	C	D
Rated voltage	300 V	-	300 V
Nominal current UL	15 A	-	10 A
Nominal current CSA	-	-	-

Conductor data:

Connection technology	CAGE CLAMP® S	
Conductor size: solid	0.2 – 2.5 mm ²	
Conductor size: fine-stranded	0.2 – 2.5 mm ²	
Conductor size: fine-stranded	0.25 – 1.5 mm ² (with insulated ferrule)	
Conductor size: fine-stranded	0.25 – 2.5 mm ² (with uninsulated ferrule)	
AWG	24 – 12	12: THHN, THWN
Strip length	9 – 10 mm / 0.35 – 0.39 in	

Material data:

Material group	I
Insulation material	Glass-fiber-reinforced polyphthalamide (PPA-GF)
Flammability rating per UL 94	V0
Lower/Upper limit temperature	-60 °C / +100 °C
Clamping spring material	Chrome nickel spring steel (CrNi)
Contact material	Electrolytic copper (E _{Cu})
Contact plating	tin-plated

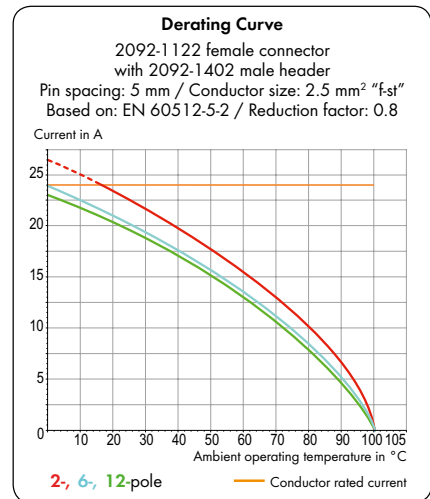

For additional derating curves, see page 72.

Accessories for picoMAX®:

Page:

Operating tools	64
Direct printing	68
Gripping plates	65
Coding pins	66
Test pin	64

The **picoMAX® pluggable connection system** includes connectors without breaking capacity in accordance with DIN EN 61984. When used as intended, these connectors shall not be connected/disconnected when live or under load. The circuit design should ensure header pins, which can be touched, are not live when unmated.



Handling picoMAX®

Pin Spacing: 3.5 mm/0.138 in; 5.0 mm/0.197 in; 7.5 mm/0.295 in



Inserting fine-stranded conductor into unmated female connector via push-button.

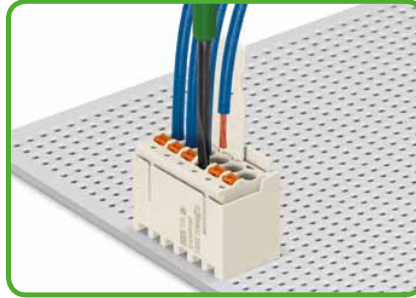

Inserting fine-stranded conductor into mated female connector via push-button.

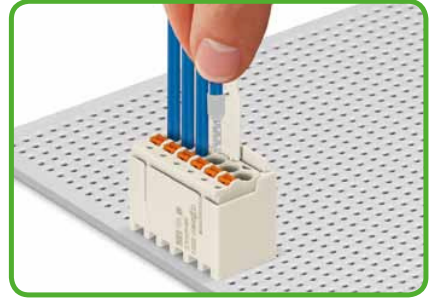

Inserting solid and ferruled conductors via push-in termination (see notes on page 75).



Easy-to-identify PCB inputs and outputs.

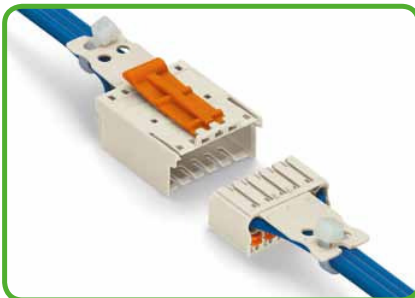

"Wire-to-wire" flying leads

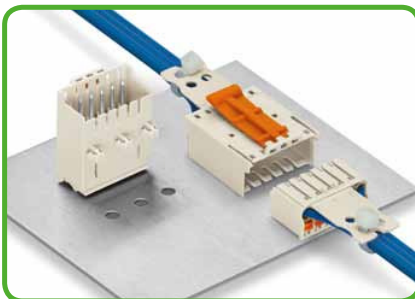
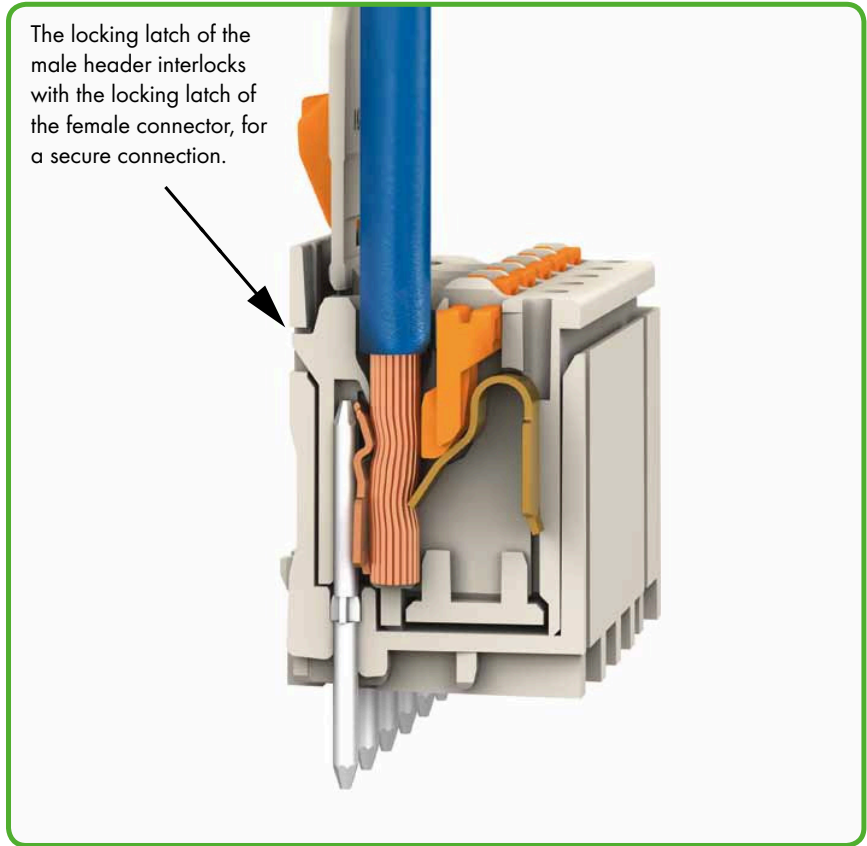

Male connectors with snap-in mounting feet for panel mounting.



Male connector with snap-in mounting feet on mounting adapter for DIN 35 rail.



Pole marking via factory direct printing.



CAGE CLAMP® S clamps the following copper conductors:

solid



stranded



fine-stranded, also with tinned single strands



Male header mated to a female connector with gripping plate and sliding connector release.

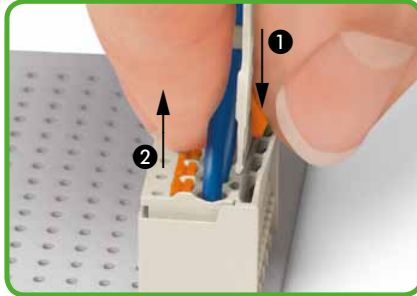

Disconnecting female connector via sliding connector release.
 ① Push down sliding connector release (gripping plate) to open the locking latch.
 ② Pull out female connector from male header.

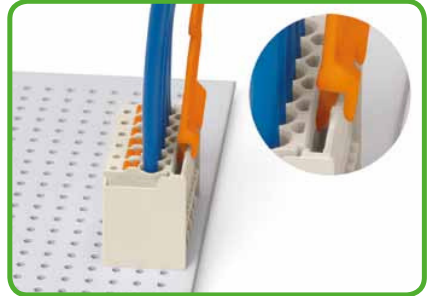

Disconnecting female connector via unlocking tool. Plug unlocking tool into the male locking latch.

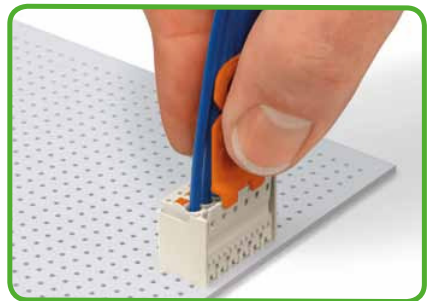
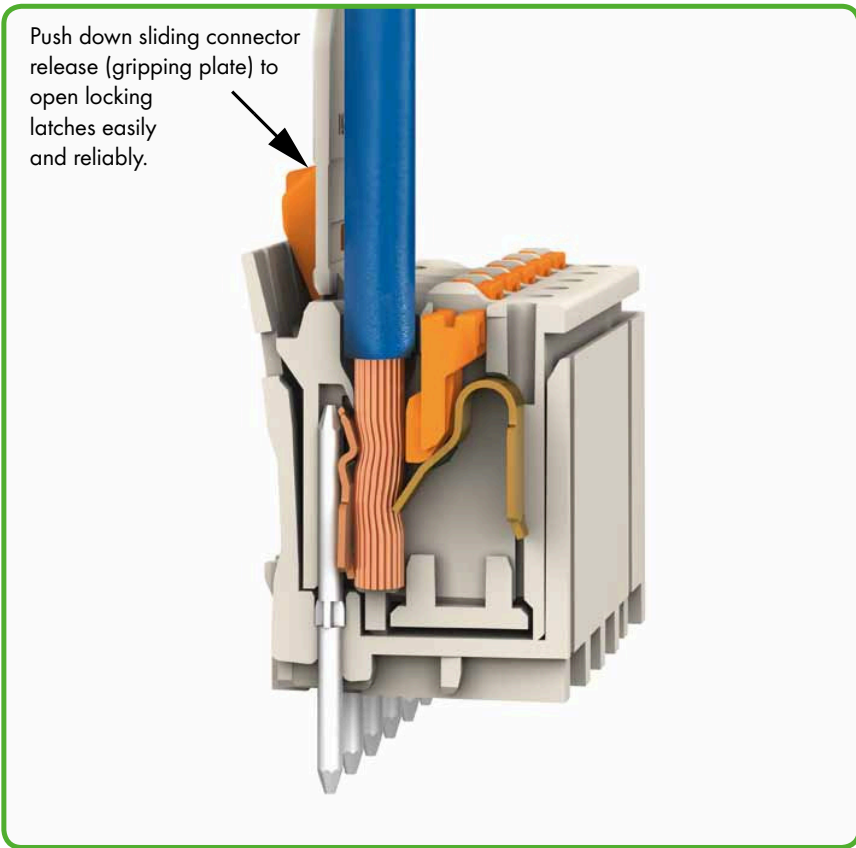

Insert unlocking tool until it hits backstop. Wedge opens locking latches.

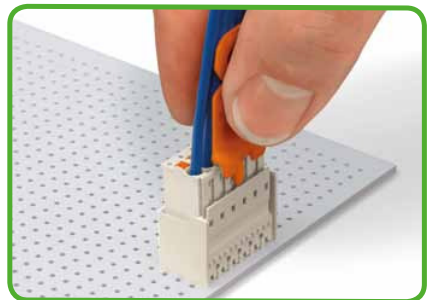

Pull on both unlocking tool and conductors to remove female connector from male header.



Coding a female connector (via coding key carrier and two keys for female connector, see symbol).

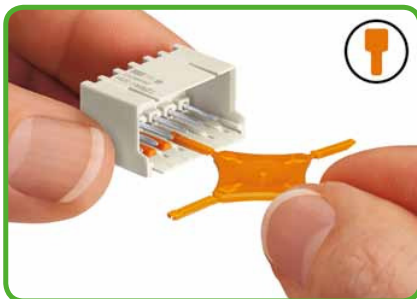

Coding a male header (via coding key carrier and two keys for male header, see symbol).

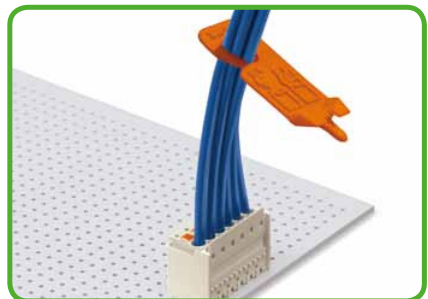

Unlocking tool may be suspended on wire harness for storage.



fine-stranded, tip-bonded



fine-stranded, with ferrule (gastight crimped)