

# (PNP) 2N6034, 2N6035, 2N6036; (NPN) 2N6038, 2N6039



ON Semiconductor®

<http://onsemi.com>

## Plastic Darlington Complementary Silicon Power Transistors

Plastic Darlington complementary silicon power transistors are designed for general purpose amplifier and low-speed switching applications.

### Features

- ESD Ratings: Machine Model, C; > 400 V  
Human Body Model, 3B; > 8000 V
- Epoxy Meets UL 94 V-0 @ 0.125 in
- Pb-Free Packages are Available\*

### MAXIMUM RATINGS

Rating	Symbol	Value	Unit
Collector-Emitter Voltage 2N6034 2N6035, 2N6038 2N6036, 2N6039	$V_{CEO}$	40 60 80	Vdc
Collector-Base Voltage 2N6034 2N6035, 2N6038 2N6036, 2N6039	$V_{CBO}$	40 60 80	Vdc
Emitter-Base Voltage	$V_{EBO}$	5.0	Vdc
Collector Current Continuous Peak	$I_C$	4.0 8.0	Adc Apk
Base Current	$I_B$	100	mAdc
Total Device Dissipation @ $T_C = 25^\circ\text{C}$ Derate above $25^\circ\text{C}$	$P_D$	40 320	W mW/ $^\circ\text{C}$
Total Device Dissipation @ $T_C = 25^\circ\text{C}$ Derate above $25^\circ\text{C}$	$P_D$	1.5 12	W mW/ $^\circ\text{C}$
Operating and Storage Junction Temperature Range	$T_J, T_{stg}$	-65 to +150	$^\circ\text{C}$

### THERMAL CHARACTERISTICS

Characteristic	Symbol	Max	Unit
Thermal Resistance, Junction-to-Case	$R_{\theta JC}$	3.12	$^\circ\text{C}/\text{W}$
Thermal Resistance, Junction-to-Ambient	$R_{\theta JA}$	83.3	$^\circ\text{C}/\text{W}$

Stresses exceeding Maximum Ratings may damage the device. Maximum Ratings are stress ratings only. Functional operation above the Recommended Operating Conditions is not implied. Extended exposure to stresses above the Recommended Operating Conditions may affect device reliability.

\*For additional information on our Pb-Free strategy and soldering details, please download the ON Semiconductor Soldering and Mounting Techniques Reference Manual, SOLDERRM/D.

## 4.0 AMPERES DARLINGTON COMPLEMENTARY SILICON POWER TRANSISTORS 40, 60, 80 VOLTS, 40 WATTS

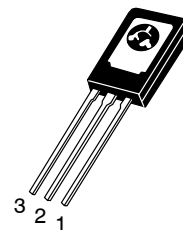
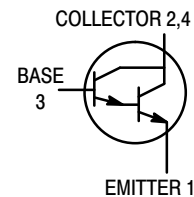

TO-225AA  
CASE 77  
STYLE 1

### MARKING DIAGRAM



Y = Year  
WW = Work Week  
2N603x = Device Code  
x = 4, 5, 6, 8, 9  
G = Pb-Free Package

### ORDERING INFORMATION

See detailed ordering and shipping information in the package dimensions section on page 5 of this data sheet.

## (PNP) 2N6034, 2N6035, 2N6036; (NPN) 2N6038, 2N6039

### ELECTRICAL CHARACTERISTICS (T<sub>C</sub> = 25°C unless otherwise noted)

Characteristic	Symbol	Min	Max	Unit
<b>OFF CHARACTERISTICS</b>				
Collector–Emitter Sustaining Voltage (I <sub>C</sub> = 100 mAdc, I <sub>B</sub> = 0)	V <sub>CE(sus)</sub>	40 60 80	– – –	Vdc
	2N6034 2N6035, 2N6038 2N6036, 2N6039			
Collector–Cutoff Current (V <sub>CE</sub> = 40 Vdc, I <sub>B</sub> = 0) (V <sub>CE</sub> = 60 Vdc, I <sub>B</sub> = 0) (V <sub>CE</sub> = 80 Vdc, I <sub>B</sub> = 0)	I <sub>CEO</sub>	– – –	100 100 100	μA
	2N6034 2N6035, 2N6038 2N6036, 2N6039			
Collector–Cutoff Current (V <sub>CE</sub> = 40 Vdc, V <sub>BE(off)</sub> = 1.5 Vdc) (V <sub>CE</sub> = 60 Vdc, V <sub>BE(off)</sub> = 1.5 Vdc) (V <sub>CE</sub> = 80 Vdc, V <sub>BE(off)</sub> = 1.5 Vdc) (V <sub>CE</sub> = 40 Vdc, V <sub>BE(off)</sub> = 1.5 Vdc, T <sub>C</sub> = 125°C) (V <sub>CE</sub> = 60 Vdc, V <sub>BE(off)</sub> = 1.5 Vdc, T <sub>C</sub> = 125°C) (V <sub>CE</sub> = 80 Vdc, V <sub>BE(off)</sub> = 1.5 Vdc, T <sub>C</sub> = 125°C)	I <sub>CEX</sub>	– – – – – –	100 100 100 500 500 500	μA
	2N6034 2N6035, 2N6038 2N6036, 2N6039			
Collector–Cutoff Current (V <sub>CB</sub> = 40 Vdc, I <sub>E</sub> = 0) (V <sub>CB</sub> = 60 Vdc, I <sub>E</sub> = 0) (V <sub>CB</sub> = 80 Vdc, I <sub>E</sub> = 0)	I <sub>CBO</sub>	– – –	0.5 0.5 0.5	mAdc
	2N6034 2N6035, 2N6038 2N6036, 2N6039			
Emitter–Cutoff Current (V <sub>BE</sub> = 5.0 Vdc, I <sub>C</sub> = 0)	I <sub>EBO</sub>	–	2.0	mAdc
<b>ON CHARACTERISTICS</b>				
DC Current Gain (I <sub>C</sub> = 0.5 Adc, V <sub>CE</sub> = 3.0 Vdc) (I <sub>C</sub> = 2.0 Adc, V <sub>CE</sub> = 3.0 Vdc) (I <sub>C</sub> = 4.0 Adc, V <sub>CE</sub> = 3.0 Vdc)	h <sub>FE</sub>	500 750 100	– 15,000 –	–
Collector–Emitter Saturation Voltage (I <sub>C</sub> = 2.0 Adc, I <sub>B</sub> = 8.0 mAdc) (I <sub>C</sub> = 4.0 Adc, I <sub>B</sub> = 40 mAdc)	V <sub>CE(sat)</sub>	– –	2.0 3.0	Vdc
Base–Emitter Saturation Voltage (I <sub>C</sub> = 4.0 Adc, I <sub>B</sub> = 40 mAdc)	V <sub>BE(sat)</sub>	–	4.0	Vdc
Base–Emitter On Voltage (I <sub>C</sub> = 2.0 Adc, V <sub>CE</sub> = 3.0 Vdc)	V <sub>BE(on)</sub>	–	2.8	Vdc
<b>DYNAMIC CHARACTERISTICS</b>				
Small–Signal Current–Gain (I <sub>C</sub> = 0.75 Adc, V <sub>CE</sub> = 10 Vdc, f = 1.0 MHz)	h <sub>fe</sub>	25	–	–
Output Capacitance (V <sub>CB</sub> = 10 Vdc, I <sub>E</sub> = 0, f = 0.1 MHz)	C <sub>ob</sub>	– –	200 100	pF
	2N6034, 2N6035, 2N6036 2N6038, 2N6039			

\*Indicates JEDEC Registered Data.

**(PNP) 2N6034, 2N6035, 2N6036; (NPN) 2N6038, 2N6039**

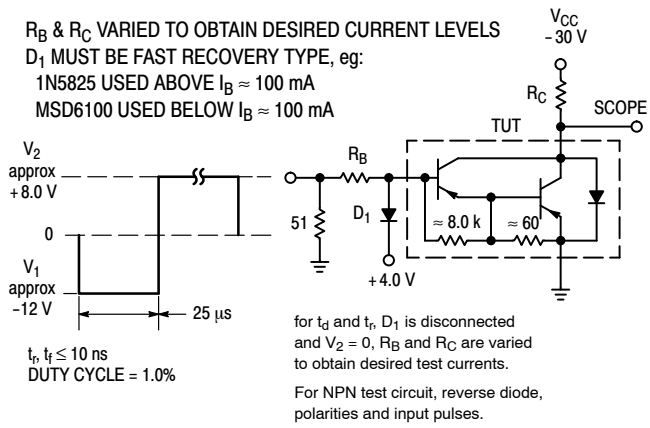

**Figure 1. Switching Times Test Circuit**

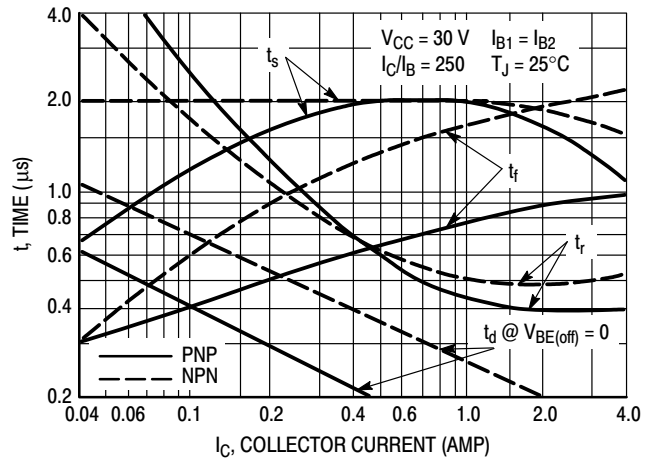

**Figure 2. Switching Times**

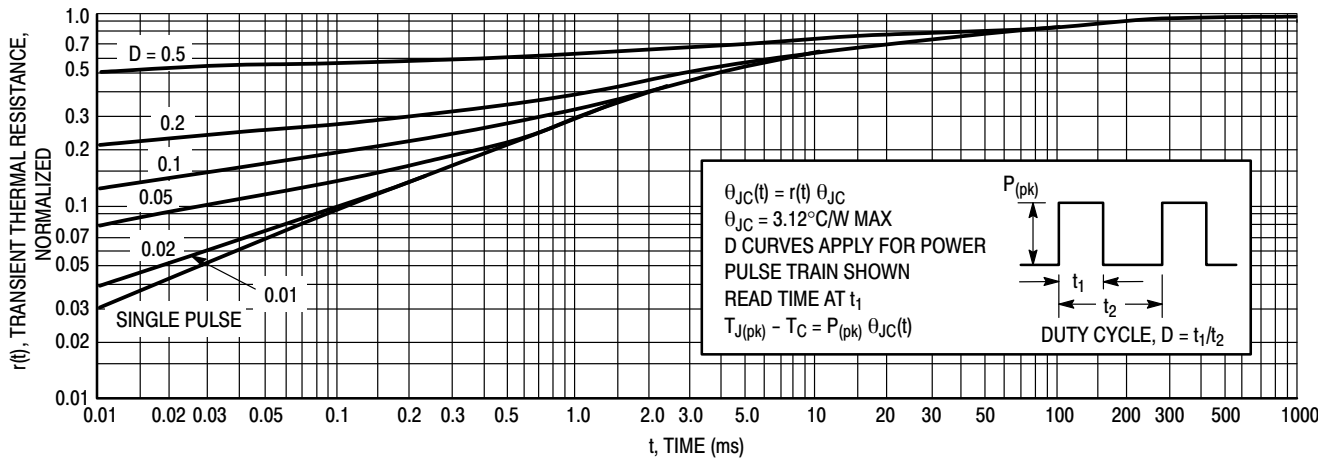

**Figure 3. Thermal Response**

(PNP) 2N6034, 2N6035, 2N6036; (NPN) 2N6038, 2N6039

ACTIVE-REGION SAFE-OPERATING AREA

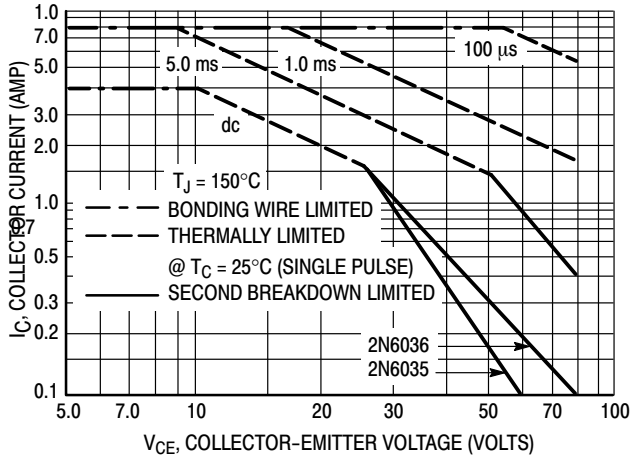

Figure 4. 2N6035, 2N6036

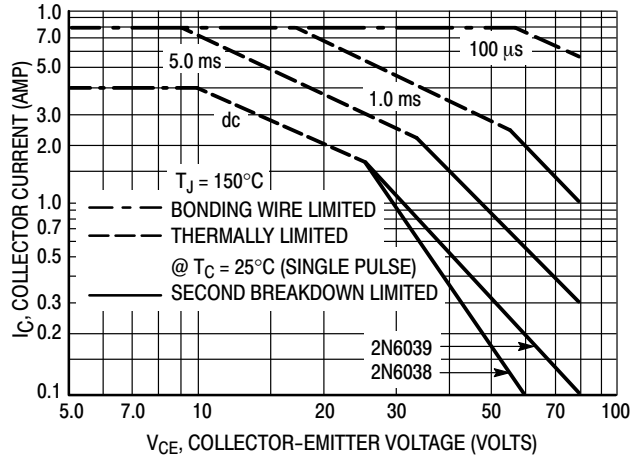

Figure 5. 2N6038, 2N6039

There are two limitations on the power handling ability of a transistor: average junction temperature and second breakdown. Safe operating area curves indicate  $I_C - V_{CE}$  limits of the transistor that must be observed for reliable operation; i.e., the transistor must not be subjected to greater dissipation than the curves indicate.

The data of Figures 4 and 5 is based on  $T_{J(pk)} = 150^\circ\text{C}$ ;  $T_C$  is variable depending on conditions. Second breakdown pulse limits are valid for duty cycles to 10% provided  $T_{J(pk)} < 150^\circ\text{C}$ .  $T_{J(pk)}$  may be calculated from the data in Figure 3. At high case temperatures, thermal limitations will reduce the power that can be handled to values less than the limitations imposed by second breakdown.

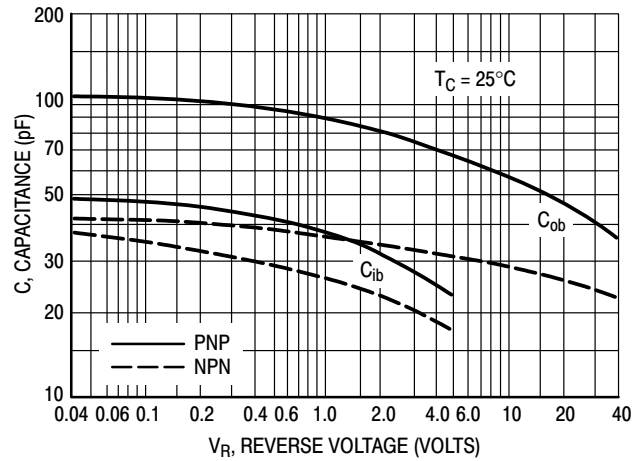
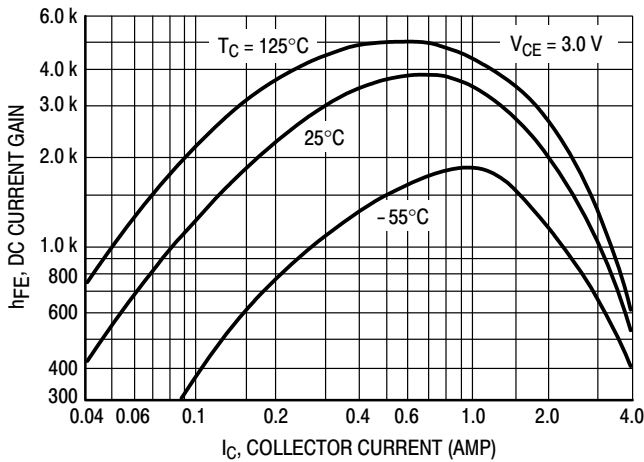

Figure 6. Capacitance

PNP  
2N6034, 2N6035, 2N6036



NPN  
2N6038, 2N6039

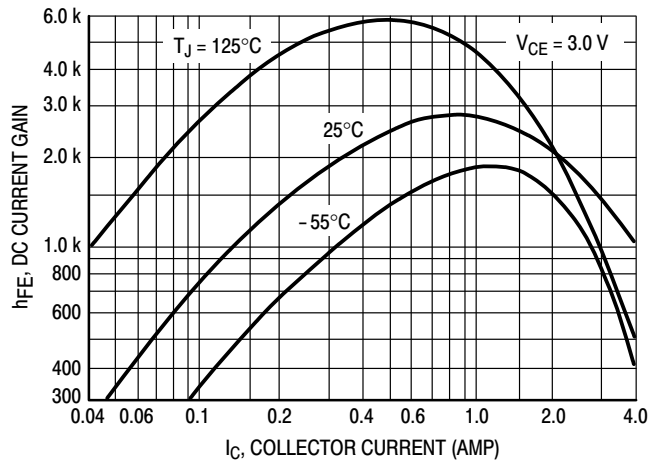

Figure 7. DC Current Gain

(PNP) 2N6034, 2N6035, 2N6036; (NPN) 2N6038, 2N6039

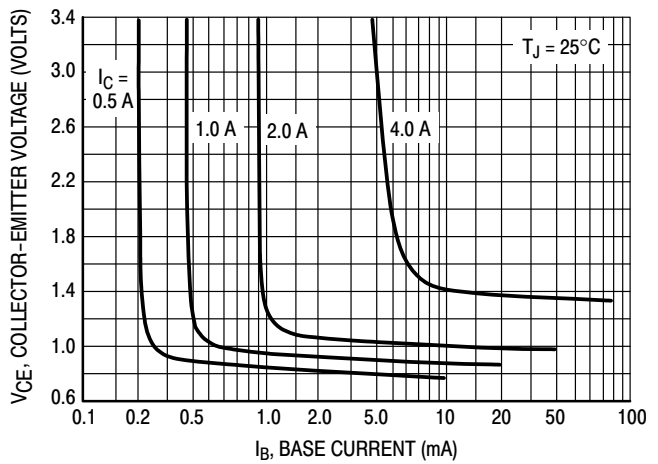
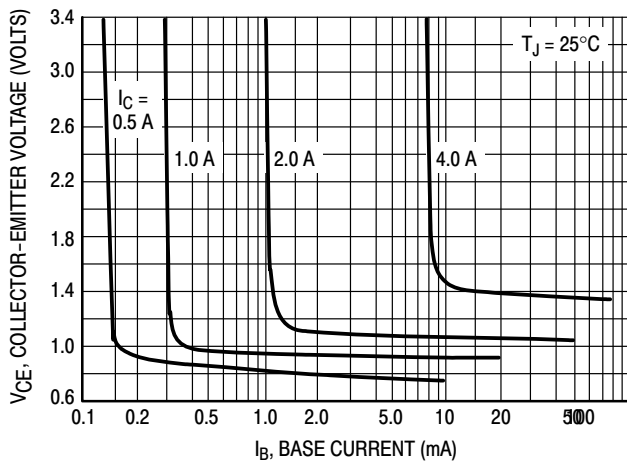

Figure 8. Collector Saturation Region

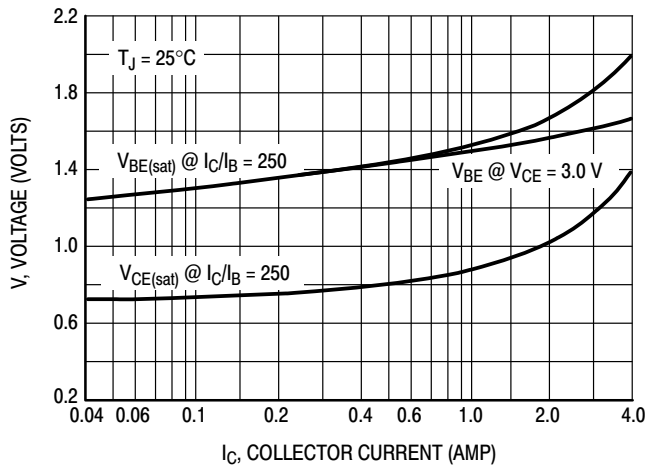
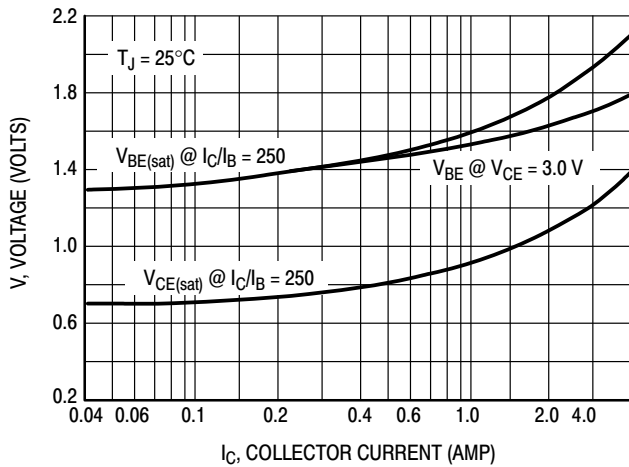

Figure 9. "On" Voltages

ORDERING INFORMATION

Device	Package	Shipping
2N6034	TO-225AA	500 Units / Box
2N6034G	TO-225AA (Pb-Free)	
2N6035	TO-225AA	
2N6035G	TO-225AA (Pb-Free)	
2N6036	TO-225AA	
2N6036G	TO-225AA (Pb-Free)	
2N6038	TO-225AA	
2N6038G	TO-225AA (Pb-Free)	
2N6039	TO-225AA	
2N6039G	TO-225AA (Pb-Free)	

# (PNP) 2N6034, 2N6035, 2N6036; (NPN) 2N6038, 2N6039

## PACKAGE DIMENSIONS

TO-225AA  
CASE 77-09  
ISSUE Z

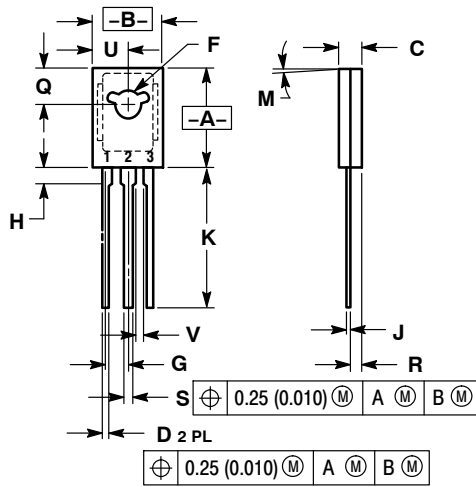

### NOTES:

1. DIMENSIONING AND TOLERANCING PER ANSI Y14.5M, 1982.
2. CONTROLLING DIMENSION: INCH.
3. 077-01 THRU -08 OBSOLETE, NEW STANDARD 077-09.

DIM	INCHES		MILLIMETERS	
	MIN	MAX	MIN	MAX
A	0.425	0.435	10.80	11.04
B	0.295	0.305	7.50	7.74
C	0.095	0.105	2.42	2.66
D	0.020	0.026	0.51	0.66
F	0.115	0.130	2.93	3.30
G	0.094 BSC		2.39 BSC	
H	0.050	0.095	1.27	2.41
J	0.015	0.025	0.39	0.63
K	0.575	0.655	14.61	16.63
M	5° TYP		5° TYP	
Q	0.148	0.158	3.76	4.01
R	0.045	0.065	1.15	1.65
S	0.025	0.035	0.64	0.88
U	0.145	0.155	3.69	3.93
V	0.040	---	1.02	---

### STYLE 1:

1. EMITTER
2. COLLECTOR
3. BASE

ON Semiconductor and are registered trademarks of Semiconductor Components Industries, LLC (SCILLC). SCILLC reserves the right to make changes without further notice to any products herein. SCILLC makes no warranty, representation or guarantee regarding the suitability of its products for any particular purpose, nor does SCILLC assume any liability arising out of the application or use of any product or circuit, and specifically disclaims any and all liability, including without limitation special, consequential or incidental damages. "Typical" parameters which may be provided in SCILLC data sheets and/or specifications can and do vary in different applications and actual performance may vary over time. All operating parameters, including "Typicals" must be validated for each customer application by customer's technical experts. SCILLC does not convey any license under its patent rights nor the rights of others. SCILLC products are not designed, intended, or authorized for use as components in systems intended for surgical implant into the body, or other applications intended to support or sustain life, or for any other application in which the failure of the SCILLC product could create a situation where personal injury or death may occur. Should Buyer purchase or use SCILLC products for any such unintended or unauthorized application, Buyer shall indemnify and hold SCILLC and its officers, employees, subsidiaries, affiliates, and distributors harmless against all claims, costs, damages, and expenses, and reasonable attorney fees arising out of, directly or indirectly, any claim of personal injury or death associated with such unintended or unauthorized use, even if such claim alleges that SCILLC was negligent regarding the design or manufacture of the part. SCILLC is an Equal Opportunity/Affirmative Action Employer. This literature is subject to all applicable copyright laws and is not for resale in any manner.

### PUBLICATION ORDERING INFORMATION

#### LITERATURE FULFILLMENT:

Literature Distribution Center for ON Semiconductor  
P.O. Box 5163, Denver, Colorado 80217 USA  
Phone: 303-675-2175 or 800-344-3860 Toll Free USA/Canada  
Fax: 303-675-2176 or 800-344-3867 Toll Free USA/Canada  
Email: orderlit@onsemi.com

N. American Technical Support: 800-282-9855 Toll Free  
USA/Canada  
Europe, Middle East and Africa Technical Support:  
Phone: 421 33 790 2910  
Japan Customer Focus Center  
Phone: 81-3-5773-3850

ON Semiconductor Website: [www.onsemi.com](http://www.onsemi.com)

Order Literature: <http://www.onsemi.com/orderlit>

For additional information, please contact your local Sales Representative

2N6035/D