

VAL-CP-RCD-3S/40/0.03

Order No.: 2882802

<http://eshop.phoenixcontact.de/phoenix/treeViewClick.do?UID=2882802>

Combination of pluggable type 2 arrester and residual current circuit breaker (RCD switch) for 3-phase power supply networks (5-conductor system: L1, L2, L3, N, PE).



Commercial data	
GTIN (EAN)	 4 046356 310048
sales group	J026
Pack	1 pcs.
Customs tariff	85363010
Catalog page information	Page 48 (TT-2011)

Product notes

WEEE/RoHS-compliant since:
12/05/2006



<http://www.download.phoenixcontact.com>
Please note that the data given here has been taken from the online catalog. For comprehensive information and data, please refer to the user documentation. The General Terms and Conditions of Use apply to Internet downloads.

Technical data

Standards

Housing material	PBT / PA
Inflammability class according to UL 94	V0
Color	light gray

Standards for air and creepage distances	IEC 61643-1
	IEC 60664-1: 1992-10
Degree of protection	IP20
Mounting type	DIN rail: 35 mm
Design	DIN rail module, two-section, divisible
Number of positions	4
Ambient temperature (operation)	-25 °C ... 40 °C
Ambient temperature (storage/transport)	-40 °C ... 60 °C
Message: Surge protection fault	Optical
Direction of action	3L-N & N-PE
Width	121.00 mm
Height	76.00 mm
Length	90.00 mm

Protective circuit

IEC category	II
	T2
EN type	T2
Nominal voltage U_N	240 V AC (230/400 V AC ... 240/415 V AC)
	415 V AC (L-L)
Arrester rated voltage U_C (L-N)	350 V AC
Arrester rated voltage U_C (N-PE)	264 V AC
U_T (TOV-proof)	415 V AC (5 s)
	1200 V AC (200 ms / N-PE)
Nominal frequency f_N	50 Hz
	60 Hz
Nominal load current I_L	40 A
Ground conductor current I_{PE}	$\leq 1 \mu A$
Standby power consumption P_C	$\leq 90 \text{ mVA}$
Max. discharge surge current I_{max} (8/20) μs maximum (L-N)	90 kA (all channels)
	30 kA
Max. discharge surge current I_{max} (8/20) μs maximum (N-PE)	30 kA
Nominal discharge surge current I_n (8/20) μs (L-N)	60 kA (all channels)
	20 kA

Nominal discharge surge current I_n (8/20) μ s (N-PE)	20 kA
Impulse operate voltage at 6 kV (1.2/50) μ s (N-PE)	≤ 1.7 kV
Protection level U_p (L-N)	≤ 2 kV
Protection level U_P (N-PE)	≤ 2 kV
Residual voltage (L-N)	≤ 1.8 kV (at I_n)
	≤ 1.5 kV (at 10 kA)
	≤ 1.2 kV (at 5 kA)
	≤ 1 kV (at 3 kA)
Residual voltage (L-PE)	≤ 2.5 kV (at I_n)
	≤ 2 kV (at 10 kA)
	≤ 1.4 kV (at 5 kA)
	≤ 1.1 kV (at 3 kA)
Residual voltage (N-PE)	≤ 0.7 kV (at I_n)
	≤ 0.4 kV (at 10 kA)
	≤ 0.3 kV (at 5 kA)
	≤ 0.2 kV (at 3 kA)
Response time (L-N)	≤ 25 ns
Response time (L-PE)	≤ 100 ns
Response time (N-PE)	≤ 100 ns

Connection, protective circuit

Connection name	Protective ground connection
Connection method	Screw connection
Connection type IN	Biconnect screw terminal block
Connection type OUT	Biconnect screw terminal block
Connection method	Biconnect terminal block
Screw thread	M5
Tightening torque	4.5 Nm
Stripping length	16 mm
Conductor cross section stranded min.	4 mm ²
Conductor cross section stranded max.	16 mm ²
Conductor cross section solid min.	4 mm ²
Conductor cross section solid max.	16 mm ²
Conductor cross section AWG/kcmil min.	12
Conductor cross section AWG/kcmil max	4

Connection name	Connection protective circuit
Connection method	Screw connection
Connection type IN	Biconnect screw terminal block
Connection type OUT	Biconnect screw terminal block
Connection method	Biconnect terminal block
Screw thread	M5
Tightening torque	4.5 Nm
Stripping length	16 mm
Conductor cross section stranded min.	4 mm ²
Conductor cross section stranded max.	25 mm ²
Conductor cross section solid min.	4 mm ²
Conductor cross section solid max.	25 mm ²
Conductor cross section AWG/kcmil min.	12
Conductor cross section AWG/kcmil max	2

Standards

Standards/regulations	IEC 61643-1 2005
	EN 61643-11 2002
	IEC 61008-1 2004
	IEC 61008-1/A11 2007
	IEC 61008-2-1 2000
	IEC 60947-3 2005

RCD switch

Dimensioning error current	30 mA
Rated making and breaking capacity I_m	1.5 kA
Rated residual making and breaking capacity $I_{\Delta m}$	2.5 kA
Surge withstand capability	6 kV (1.2/50 μ s)
Immunity to short-circuiting I_{nc}	10 kA Back-up fuse: 63 A
Tripping time for $I_{\Delta n}$	≤ 300 ms
Tripping time for $5xI_{\Delta n}$	≤ 40 ms
Cycles, max.	20000
Utilization category	AC 23 A
Class	A
Insulation voltage U_i	440 V

Certificates / Approvals



Certification

CB, CCA, GOST, KEMA, OEVE, VDE-PZI

Accessories

Item Designation Description

Bridges

2880684	MPB SET VAL-CP-3S	Wiring bridge set, consisting of three flexible bridges 15 cm black, 1 bridge 27 cm blue.
---------	-------------------	---

Diagrams/Drawings

Connection diagram

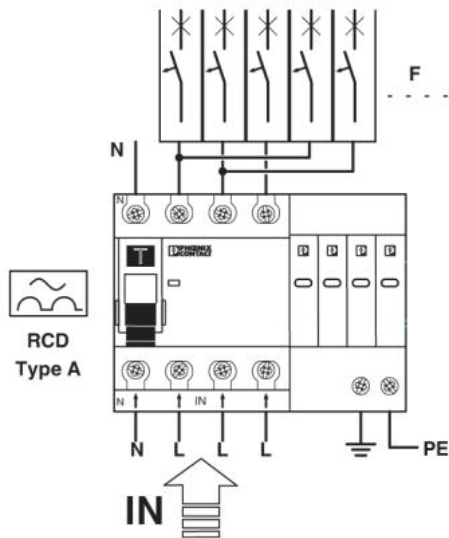

Functional drawing

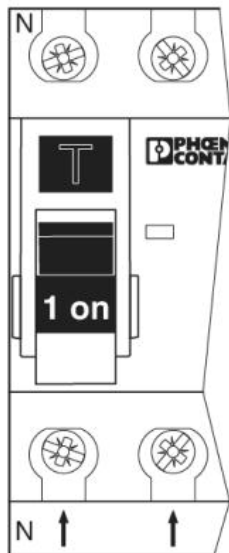
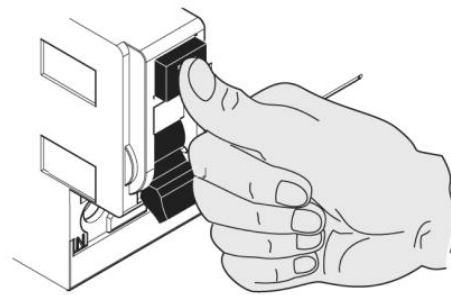
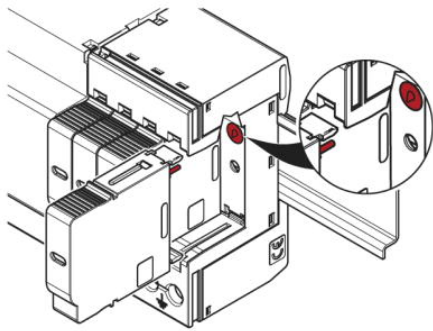
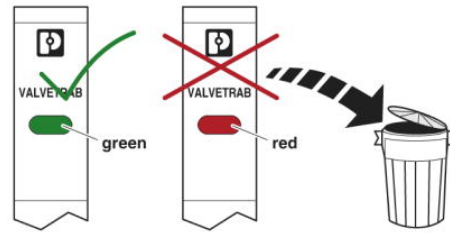
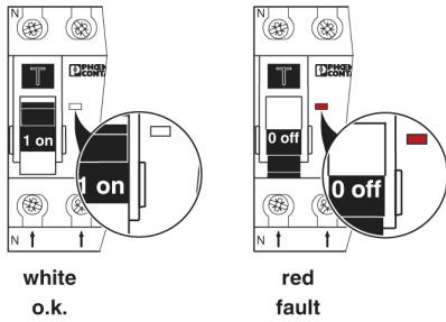

=> ok

Dimensioned drawing

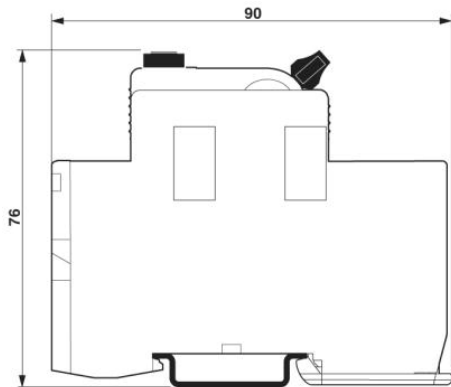

Circuit diagram

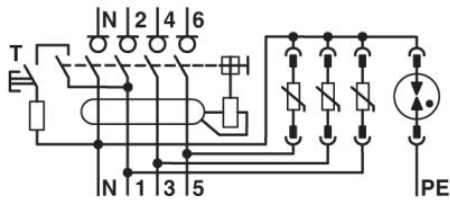

Address

PHOENIX CONTACT Inc., USA
586 Fulling Mill Road
Middletown, PA 17057, USA
Phone (800) 888-7388
Fax (717) 944-1625
<http://www.phoenixcon.com>



© 2011 Phoenix Contact
Technical modifications reserved;