

**4900-5875 MHz Single Band Antenna**  
(IEEE 802.11 a/g/n/ac, includes frequencies of Wi-Fi products)

**Part Number: 2118316-1**

**Product Facts**

- This small embedded antenna provides the most reliable easy-to-use, and adjustment-free antenna technology for handling during assembly and implementation by developers.
- Available in tray (2118316-2) or tape & reel (2118316-1) for automatic mounting.
- RoHS compliant.



**Recommendations**

- Minimum or no matching circuits required.
- Bandwidth and performance is dependent on ground plane size. Suggested minimum ground plane length from the antenna feed is 15 mm.
- PCB ground is to be on top layer.

**Specifications**

Frequency Range (MHz)	4900–5875
Peak Gain	+4.9 dBi
VSWR	< 2.5:1
Polarization	Linear
Azimuth Beamwidth	Omni-directional
Power Handling	3 Watt cw
Feed Point Impedance	50 Ohms unbalanced
Size	11.00 mm x 4.25 mm x 4.90 mm
Weight	0.2 g.
Mounting	Surface-mount technology. See diagram on page 2.
Keep Out Area	See diagram on page 2.

**Test Orientation in Free Space**

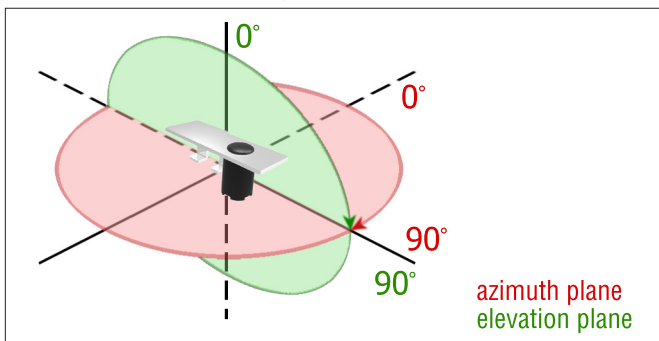

**VSWR**

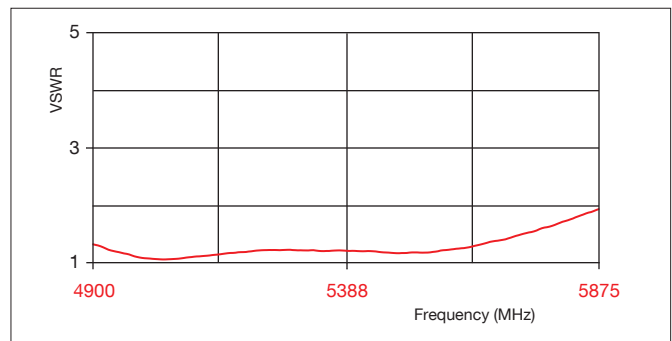

**Azimuth**

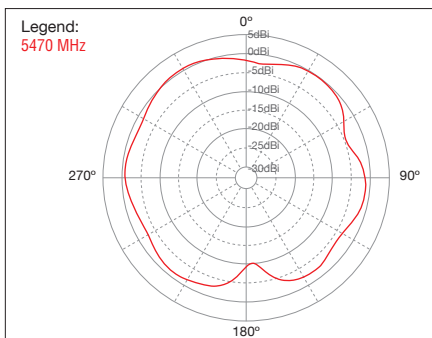

**Elevation**

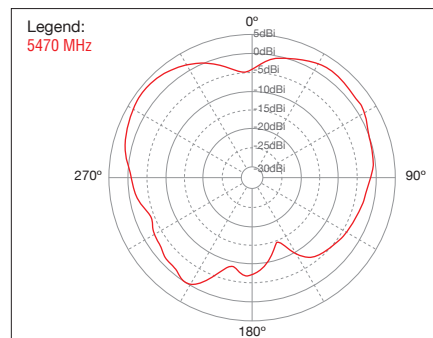

**Efficiency**

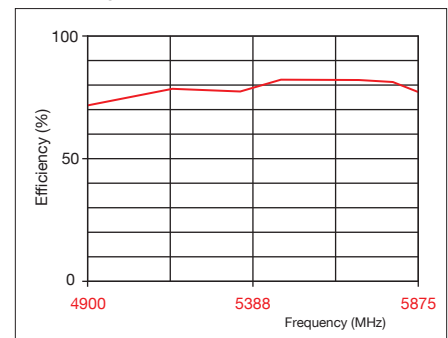

**4900-5875 MHz Single Band Antenna**  
(IEEE 802.11 a/g/n/ac, includes frequencies of Wi-Fi products)

**Part Number: 2118316-1**

**Mounting Guide**

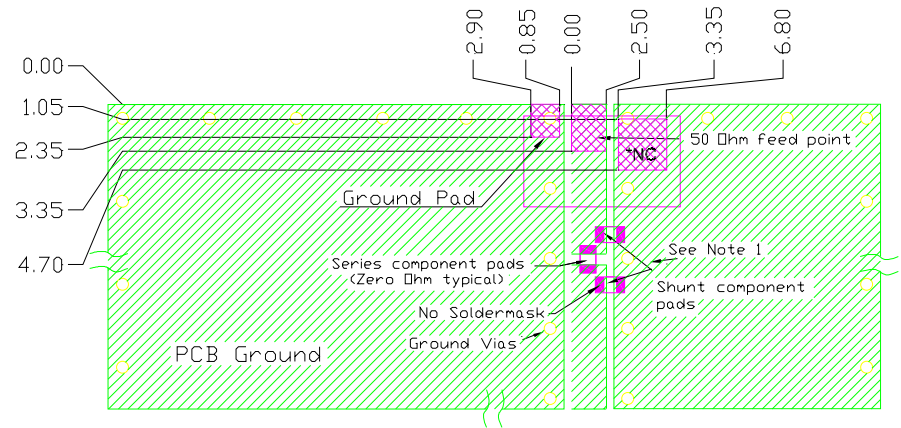

Dimensions: mm  
Diagram is not to scale

- NOTES:**
1. Suggested matching component pads.
  2. Antenna must be mounted on the edge of PCB.
  3. NC = No connection (mechanical mounting pads).
  4. For more information please call TE.

**Keep Out Area**

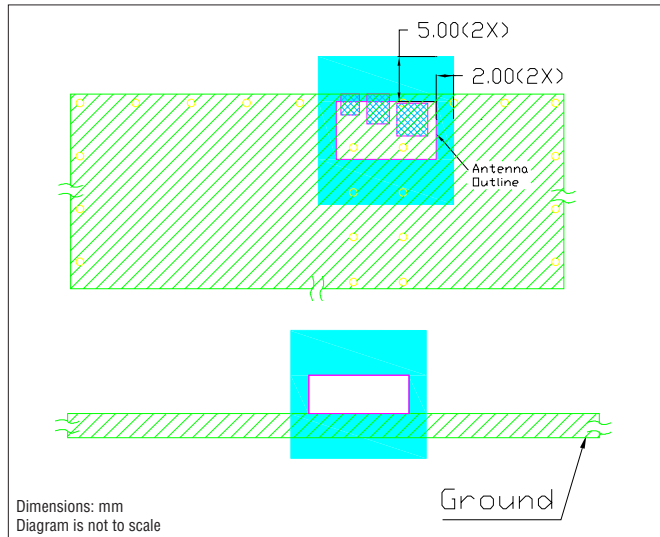

**Approx. Dimensions**

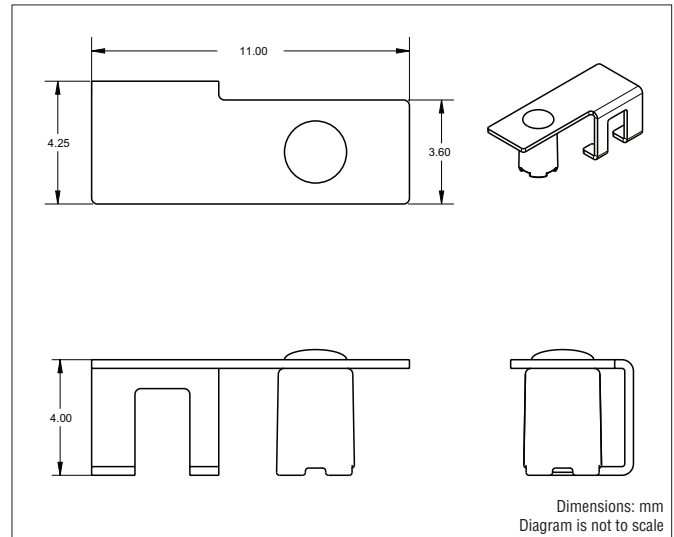

© 2014 TE Connectivity family of companies. All Rights Reserved.

1-1773726-6-CSD-PDF-02-14

TE (logo) and TE Connectivity are trademarks.

Wi-Fi is trademark. Other logos, products and company names mentioned herein may be trademarks of their respective owners.

While TE has made every reasonable effort to ensure the accuracy of the information in this catalog, TE does not guarantee that it is error-free, nor does TE make any other representation, warranty or guarantee that the information is accurate, correct, reliable or current. TE reserves the right to make any adjustments to the information contained herein at any time without notice. TE expressly disclaims all implied warranties regarding the information contained herein, including, but not limited to, any implied warranties of merchantability or fitness for a particular purpose. The dimensions in this catalog are for reference purposes only and are subject to change without notice. Specifications are subject to change without notice.

Consult TE for the latest dimensions and design specifications.

9565 Soquel Drive  
Aptos, CA 95003  
(+ 831) 662-1174  
www.antenna.te.com