

ohne / without

Mutter / nut

max. Einschraubtiefe 5.0 mm  
thread depth max. 5.0 mm

Bolzen / bolt

max. Einschraubtiefe 5.5 mm  
thread depth max. 5.5 mm

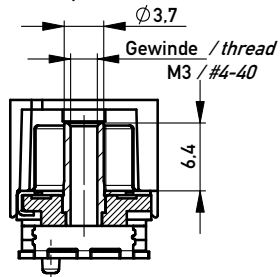
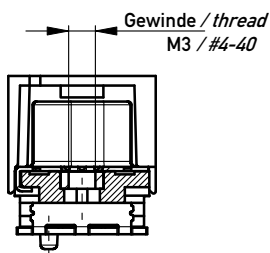
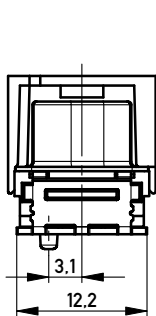

Beschriftung nach Bedruckungsvorschrift 174538  
Part marking according to specification 174538

| 194250                               | 174385                        | X               |                  |                |                     |
|--------------------------------------|-------------------------------|-----------------|------------------|----------------|---------------------|
| 194251                               | 204263                        |                 |                  | #4-40          |                     |
| 194252                               | 164009                        |                 |                  | M3             |                     |
| 194253                               | 164005                        |                 | #4-40            |                |                     |
| 194254                               | 164001                        |                 | M3               |                |                     |
| Ident-Nr.<br>part-no.<br>tape & reel | Ident-Nr.<br>part-no.<br>tray | ohne<br>without | Mutter<br>thread | Bolzen<br>bolt | Bemerkung<br>remark |

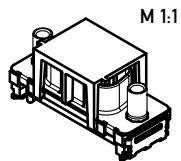

Anschlussbereich verzinkt  
terminal area tin plating

Koplanarität der Anschlüsse ≤ 0.1 mm  
coplanarity area of termination ≤ 0.1 mm

Anforderungsstufe: 2  
class: 2

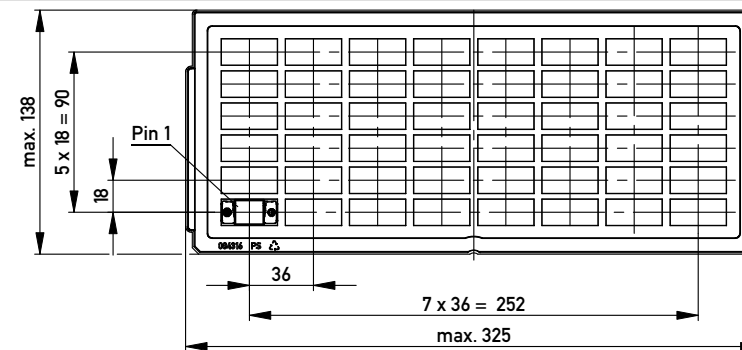

Verpackt in Tray  
Verpackungseinheit 48 St.  
tray packaging  
packaging unit 48 pcs

Sonstige Angaben siehe Zeichnung 204628 / Additional indications according to drawing 204628

Verpackt in Gurtverpackung - Tape on Reel Packaging  
Verpackungseinheit: 120 Stück - Packaging unit: 120 pcs

Abspulrichtung - Reel off Direction

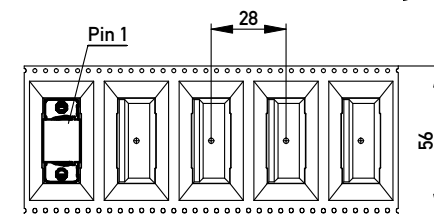
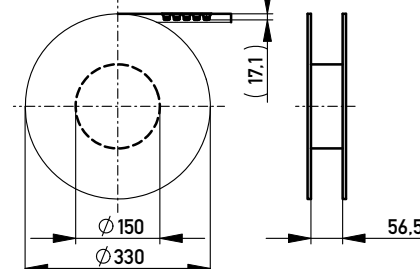

Sonstige Angaben siehe Zeichnung 204654 / Additional indications according to drawing 204654

Layoutvorschlag:  
recommended layout:

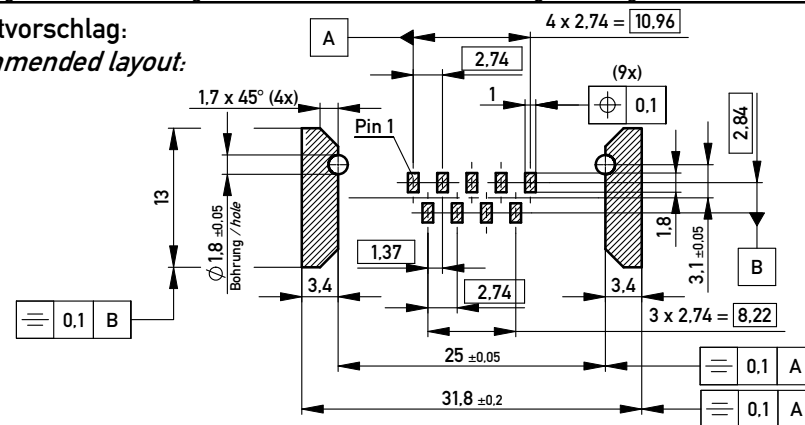

Fehlende Masse und Angaben siehe DIN 41652 / Missing information and dimensions according to DIN 41652

Sonstige Angaben siehe Fertigungsunterlagen / Additional indications please see the production documentation

|  |   |   |
|--|---|---|
| Information:   | Tolerances  | Scale 2:1                                       |
| All rights reserved.<br>Only for Information.<br>To ensure that this is the latest version of this drawing, please contact one of the ERNI companies before using. | Subject to modification without prior notice.<br>Drawing will not be updated. | Designation                                     |
|  |   | TMC-P 09-SMD-6.3-BA8<br>TMC-P 09-SMD-6.3-type 8 |
| www.ERNI.com   | 144889  | I   |
| Class  | TMCP  | A3  |

Copyright by ERNI GmbH  
Proprietary notice pursuant to ISO 16106 to be observed.

f 21.04.2010  
Index Date

# Mouser Electronics

Authorized Distributor

Click to View Pricing, Inventory, Delivery & Lifecycle Information:

[ERNI Electronics:](#)

[194253](#)