

EAO – Your Expert Partner for  
Human Machine Interfaces

Switches Unlimited  
Contact: sales@switchesunlimited.com  
Phone: 800-221-0487 \* Fax: 718-672-6370  
www.switchesunlimited.com



## EAO Product Information

Series 18

eao ■

Description .....	3
Product Assembly .....	4
Devices raised mounting .....	5
Devices flush mounting .....	6
Accessories.....	7
Technical Data.....	10
Drawings.....	11
Index.....	15

## Product Information

### General notes

The series 18 comprises compact indicators for direct connection to 2.2, 12 or 24 VDC and illuminated pushbuttons with maintained or momentary action.

The illuminated pushbuttons are equipped with a snap-action switching system with normally open or normally closed contacts.

The dimensions of the front are 9 x 14 mm, 9 x 9 mm or 9 mm dia.

Indicators and illuminated pushbuttons for use with overhanging lenses 14 x 14 mm or 14 mm dia. are also available for flush mounting.

### Mounting

Mounting from the front through the mounting hole 8 mm dia.

(15.8 x 15.8 mm resp. 16 mm dia. for flush mounting) is assured even with the wiring already attached.

The units are provided with soldering terminals.

### Lenses

The flat lenses are available in various colours and a transparent version. The surface is nonreflecting (matt).

### Illumination

Perfect illumination of the lenses, which can be supplied in various colours, is assured by Bi-Pin T1 LEDs (2.2 VDC) in the colours red, yellow and green.

(Compact indicators for connection to 12 or 24 VDC.) The Bi-Pin T1 LED are already integrated in the lenses.

Luminosity and wave length scattering caused by the technology used in the LED manufacturing processes may lead to visual differences in our products.

### Position indication

The status of a maintained action switch can be determined by the position of the lens.

## Specimen order

### Illuminated pushbutton :

- Illuminated pushbutton actuator, 9 x14 mm, momentary action, 1 normally open, soldering terminal 18-147.035

### Essential accessories :

- Lens with LED plastic yellow, transparent, flush, 9 x 14 mm 18-941.4

*We reserve the right to modify technical data*

*All dimensions in mm*

## Pushbutton illuminative, raised mounting

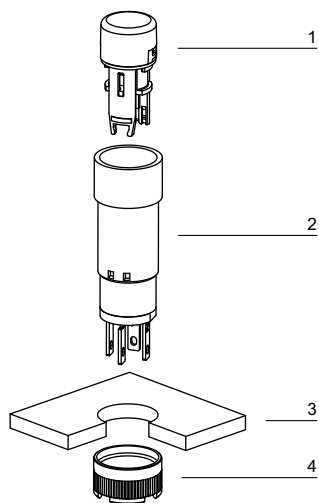

- 1 Lens
- 2 Switch housing
- 3 Front panel
- 4 Fixing nut

## Pushbutton illuminative, flush mounting

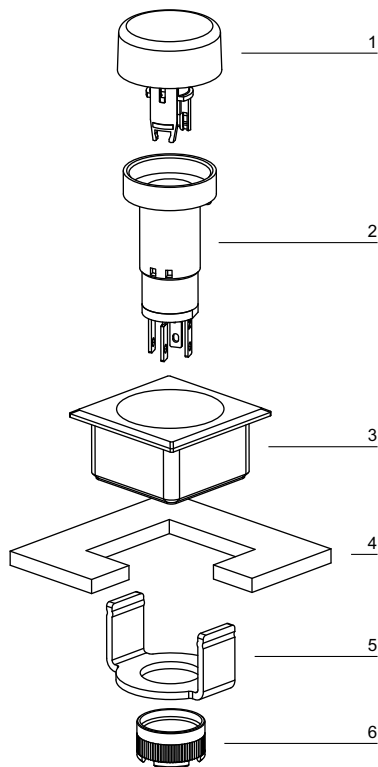

- 1 Lens
- 2 Switch housing
- 3 Front bezel set (upper part)
- 4 Front panel
- 5 Front bezel set (lower part)
- 6 Fixing nut

## Indicator



	Front protection	Operating voltage/-current	Lens	Terminals	Ø 9 x 9 mm Typ-Nr.	Ø 9 x 14 mm Typ-Nr.	Ø 9 mm Typ-Nr.	Component layout	Mounting dimensions	Technical drawing	Circuit drawing	
<b>Indicator</b>	IP 40	12 VDC, 20 mA	Plastic green	S	<b>18-051.0055</b>	<b>18-041.0055</b>	<b>18-031.0055</b>	1	1	1	1	0.002
			Plastic red	S	<b>18-051.0052</b>	<b>18-041.0052</b>	<b>18-031.0052</b>	1	1	1	1	0.002
			Plastic yellow	S	<b>18-051.0054</b>	<b>18-041.0054</b>	<b>18-031.0054</b>	1	1	1	1	0.002
		2.2 VDC, 20 mA	Plastic green	S	<b>18-050.0055</b>	<b>18-040.0055</b>	<b>18-030.0055</b>	1	1	1	1	0.002
			Plastic red	S	<b>18-050.0052</b>	<b>18-040.0052</b>	<b>18-030.0052</b>	1	1	1	1	0.002
			Plastic yellow	S	<b>18-050.0054</b>	<b>18-040.0054</b>	<b>18-030.0054</b>	1	1	1	1	0.002
		24 VDC, 20 mA	Plastic green	S	<b>18-052.0055</b>	<b>18-042.0055</b>	<b>18-032.0055</b>	1	1	1	1	0.002
			Plastic red	S	<b>18-052.0052</b>	<b>18-042.0052</b>	<b>18-032.0052</b>	1	1	1	1	0.002
			Plastic yellow	S	<b>18-052.0054</b>	<b>18-042.0054</b>	<b>18-032.0054</b>	1	1	1	1	0.002

Terminals: S = Soldering terminal

Component layout from page 11, Mounting dimensions from page 12, Technical drawing from page 12, Circuit drawing from page 13

## Illuminated pushbutton actuator



### Essential Accessories:

 Lens with LED page 7

	Front protection	Switching system	Contacts	Switching action	Terminals	Ø 9 x 9 mm Typ-Nr.	Ø 9 x 14 mm Typ-Nr.	Ø 9 mm Typ-Nr.	Component layout	Mounting dimensions	Technical drawing	Circuit drawing	
<b>Illuminated pushbutton actuator</b>	IP 40	SA	1 NC	MA	S	<b>18-258.035</b>	<b>18-248.035</b>	<b>18-238.035</b>	2	1	2	2	0.002
				M	S	<b>18-158.035</b>	<b>18-148.035</b>	<b>18-138.035</b>	2	1	2	4	0.002
			1 NO	MA	S	<b>18-257.035</b>	<b>18-247.035</b>	<b>18-237.035</b>	2	1	2	3	0.002
				M	S	<b>18-157.035</b>	<b>18-147.035</b>	<b>18-137.035</b>	2	1	2	5	0.002

Switching system: SA = Snap-action switching element

Contacts: NC = Normally closed, NO = Normally open

Switching action: MA = Maintained action, M = Momentary action

Terminals: S = Soldering terminal

Component layout from page 11, Mounting dimensions from page 12, Technical drawing from page 12, Circuit drawing from page 13

## Indicator actuator, flush mounting



### Essential Accessories:

Front bezel set, flush mounting page 8

	Front protection	Operating voltage/-current	Lens	Terminals	□ 19 x 19 mm Typ-Nr.	∅ 19 mm Typ-Nr.	Component layout	Mounting dimensions	Technical drawing	Circuit drawing	
<b>Indicator actuator, flush mounting</b>	IP 40	12 VDC, 20 mA	Plastic green	S	<b>18-081.0055</b>	<b>18-061.0055</b>	2	2	3	1	0.003
			Plastic red	S	<b>18-081.0052</b>	<b>18-061.0052</b>	2	2	3	1	0.003
			Plastic yellow	S	<b>18-081.0054</b>	<b>18-061.0054</b>	2	2	3	1	0.003
		2.2 VDC, 20 mA	Plastic green	S	<b>18-080.0055</b>	<b>18-060.0055</b>	2	2	3	1	0.002
			Plastic red	S	<b>18-080.0052</b>	<b>18-060.0052</b>	2	2	3	1	0.002
			Plastic yellow	S	<b>18-080.0054</b>	<b>18-060.0054</b>	2	2	3	1	0.002
		24 VDC, 20 mA	Plastic green	S	<b>18-082.0055</b>	<b>18-062.0055</b>	2	2	3	1	0.003
			Plastic red	S	<b>18-082.0052</b>	<b>18-062.0052</b>	2	2	3	1	0.003
			Plastic yellow	S	<b>18-082.0054</b>	<b>18-062.0054</b>	2	2	3	1	0.003

Terminals: S = Soldering terminal

Component layout from page 11, Mounting dimensions from page 12, Technical drawing from page 12, Circuit drawing from page 13

## Illuminated pushbutton actuator, flush mounting



### Essential Accessories:

Front bezel set, flush mounting page 8

Lens with LED, flush mounting page 7

	Front protection	Switching system	Contacts	Switching action	Terminals	□ 19 x 19 mm Typ-Nr.	∅ 19 mm Typ-Nr.	Component layout	Mounting dimensions	Technical drawing	Circuit drawing	
<b>Illuminated pushbutton actuator, flush mounting</b>	IP 40	SA	1 NC	MA	S	<b>18-288.035</b>	<b>18-268.035</b>	2	2	4	2	0.002
				M	S	<b>18-188.035</b>	<b>18-168.035</b>	2	2	4	4	0.002
			1 NO	MA	S	<b>18-287.035</b>	<b>18-267.035</b>	2	2	4	3	0.002
				M	S	<b>18-187.035</b>	<b>18-167.035</b>	2	2	4	5	0.002

Switching system: SA = Snap-action switching element

Contacts: NC = Normally closed, NO = Normally open

Switching action: MA = Maintained action, M = Momentary action

Terminals: S = Soldering terminal

Component layout from page 11, Mounting dimensions from page 12, Technical drawing from page 12, Circuit drawing from page 13

## Front

### Lens without LED

	Lens	∅ 9 x 9 mm Typ-Nr.	∅ 9 x 14 mm Typ-Nr.	∅ 9 mm Typ-Nr.	
<b>Lens without LED</b> illuminative	Plastic green translucent flush	<b>18-952.5</b>	<b>18-942.5</b>	<b>18-932.5</b>	0.001
	Plastic red translucent flush	<b>18-952.2</b>	<b>18-942.2</b>	<b>18-932.2</b>	0.001
	Plastic white translucent flush	<b>18-952.9</b>	<b>18-942.9</b>	<b>18-932.9</b>	0.001
	Plastic yellow translucent flush	<b>18-952.4</b>	<b>18-942.4</b>	<b>18-932.4</b>	0.001
non-illuminative	Plastic black opaque flush	<b>18-952.0</b>	<b>18-942.0</b>	<b>18-932.0</b>	0.001
	Plastic grey opaque flush	<b>18-952.8</b>	<b>18-942.8</b>	<b>18-932.8</b>	0.001



### Lens with LED

	Lens	∅ 9 x 9 mm Typ-Nr.	∅ 9 x 14 mm Typ-Nr.	∅ 9 mm Typ-Nr.	
<b>Lens with LED</b> without built-in series resistor, typ. forward voltage 2.2 VDC, 20 mA	Plastic green translucent flush	<b>18-951.5</b>	<b>18-941.5</b>	<b>18-931.5</b>	0.001
	Plastic red translucent flush	<b>18-951.2</b>	<b>18-941.2</b>	<b>18-931.2</b>	0.001
	Plastic yellow translucent flush	<b>18-951.4</b>	<b>18-941.4</b>	<b>18-931.4</b>	0.001



### Lens without LED, flush mounting

	Lens	∅ 19 x 19 mm Typ-Nr.	∅ 19 mm Typ-Nr.	
<b>Lens without LED, flush mounting</b> illuminative	Plastic green translucent flush	<b>18-982.5</b>	<b>18-962.5</b>	0.001
	Plastic red translucent flush	<b>18-982.2</b>	<b>18-962.2</b>	0.001
	Plastic white translucent flush	<b>18-982.9</b>	<b>18-962.9</b>	0.001
	Plastic yellow translucent flush	<b>18-982.4</b>	<b>18-962.4</b>	0.001
non-illuminative	Plastic black opaque flush	<b>18-982.0</b>	<b>18-962.0</b>	0.001
	Plastic grey opaque flush	<b>18-982.8</b>	<b>18-962.8</b>	0.001



### Lens with LED, flush mounting

	Lens	∅ 19 x 19 mm Typ-Nr.	∅ 19 mm Typ-Nr.	
<b>Lens with LED, flush mounting</b> without built-in series resistor, typ. forward voltage 2.2 VDC, 20 mA	Plastic green translucent flush	<b>18-981.5</b>	<b>18-961.5</b>	0.001
	Plastic red translucent flush	<b>18-981.2</b>	<b>18-961.2</b>	0.001
	Plastic yellow translucent flush	<b>18-981.4</b>	<b>18-961.4</b>	0.001



## Front bezel set, flush mounting

		Ø 19 x 19 mm Typ-Nr.	Ø 19 mm Typ-Nr.	Mounting dimensions	
<b>Front bezel set, flush mounting</b> for Lens round	Front bezel Plastic black	<b>18-920.2</b>	<b>18-920.3</b>	2	0.006
for Lens square	Plastic black	<b>18-920.1</b>		2	0.006



Mounting dimensions from page 12

## Blind plug

		Ø 9 x 9 mm Typ-Nr.	Ø 9 mm Typ-Nr.	Mounting dimensions	
<b>Blind plug</b>		<b>19-948.0</b>	<b>19-949.0</b>	3	0.001



Mounting dimensions from page 12

## Backside

### PCB plug-in base

	Terminals	Typ-Nr.	Component layout	Technical drawing	
<b>PCB plug-in base</b> Pins axial	P	<b>18-945</b>	3	5	0.001
Pins bent at right-angles	P	<b>18-946</b>	4	6	0.001



Terminals: P = PCB terminal  
Component layout from page 11, Technical drawing from page 12

## Assembling

### Lens remover

	Typ-Nr.	
<b>Lens remover</b>	<b>18-910</b>	0.002





## Mounting tool

	Typ-Nr.	
<b>Mounting tool</b> for Fixing nut long 19-991	<b>19-905</b>	0.011



## Actuator with snap-action switching element

### Switching system

The snap-action switching system was designed for switching low powers in electronic circuits.  
Single-break snap-action contact.

### Material

#### Lens

Polymethylacrylate (PMMA), Polycarbonate (PC)

#### Material of contact

Gold contact on nickel plating

#### Actuator housing

Polyamide, colour black

### Mechanical characteristics

#### Terminals

The terminals can be used as soldering terminals.  
Max.wire diameter: 2 x 0.5 mm<sup>2</sup>  
Max.wire ccross-section of stranded cable 1 x 0.75 mm<sup>2</sup>  
Wire cross-section of terminal 1.6 x 0.4 mm

#### Tightening torque

for fixing nut max. 20 Ncm

#### Actuating force

1.4 N

#### Actuating travel

2.2 mm ±0.2 mm

#### Rebound time

≤2.5 ms

#### Mechanical lifetime

Momentary action 2 million cycles of operation  
Maintained action 1 million cycles of operation,  
as per IEC 60512-5-9a

### Electrical characteristics

#### Contact resistance

≤100 mΩ starting value (initial), as per IEC 60512-2-2b

#### Electrical life

≥500 000 cycles of operation at 30 VDC, 100 mA, as per IEC 60512-5-9c

#### Power consumption LED

20 mA

#### Switch rating

min. 10 μA at 100 μV  
max. 100 mA at 42 VAC/VDC

#### Electric strength

500 VAC, 50 Hz, 1 min. between all terminals and earth, as per IEC 60512-2-11

### Environmental conditions

#### Storage temperature

-40 °C ... +80 °C

#### Service temperature

-25 °C ... +65 °C

#### Protection degree

IP 40 front side, as per IEC 60529

#### Shock resistance

(Single impacts, semi-sinusoidal)  
50 g for 11 ms, as per IEC 60068-2-27

#### Vibration resistance

(sinusoidal)10 g at 10-2000 Hz, amplitude 0.75 mm, as per IEC 60512-4-4

### Approvals

#### Declaration of conformity

RoHS

## Component layout

### 1 Indicator page 5

9 x 9 mm

9 x 14 mm

Ø9 mm

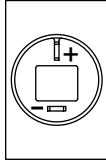
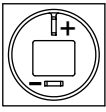

### 2 Illuminated pushbutton actuator page 5 | Indicator actuator, flush mounting page 6 | Illuminated pushbutton actuator, flush mounting page 6

9 x 9 mm

9 x 14 mm

Ø9 mm

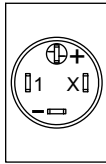
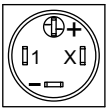

X contact-nr.  
2 = NO  
4 = NC

### 3 PCB plug-in base page 8

Drilling plan (element side)  
Through-connection recommended

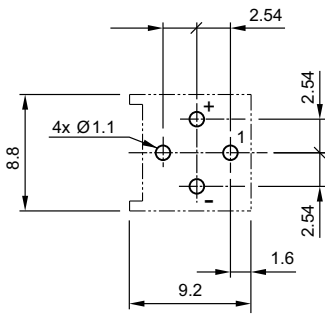

### 4 PCB plug-in base page 8

Drilling plan (element side)  
Through-connection recommended

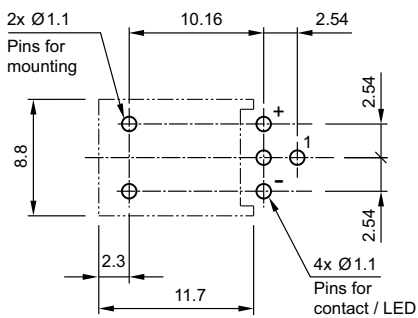

## Mounting dimensions

### 1 Indicator page 5 | Illuminated pushbutton actuator page 5

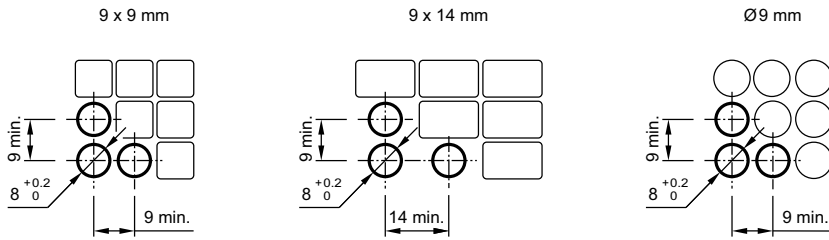

### 2 Indicator actuator, flush mounting page 6 | Illuminated pushbutton actuator, flush mounting page 6 | Front bezel set, flush mounting page 8

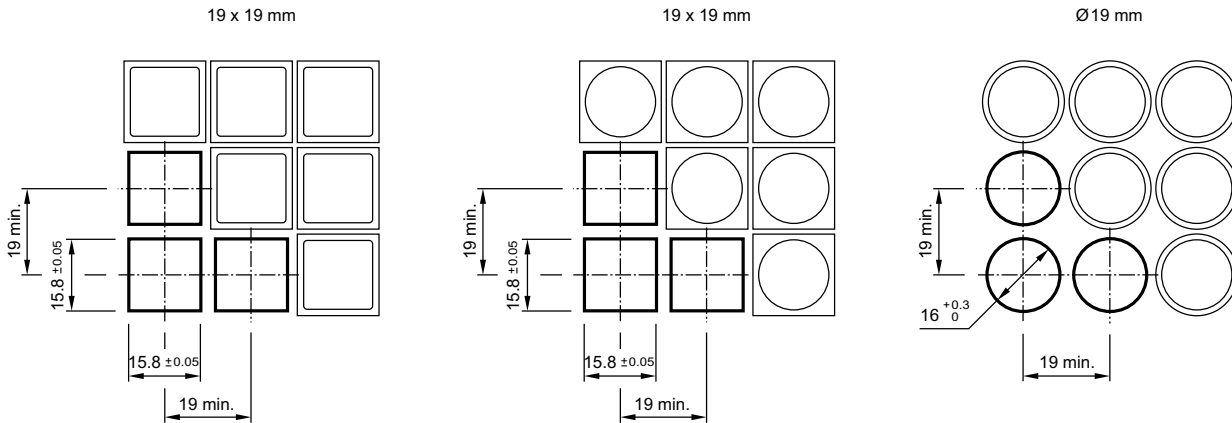

### 3 Blind plug page 8

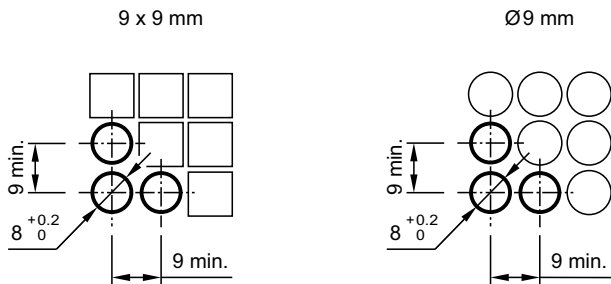

## Technical drawing

### 1 Indicator page 5

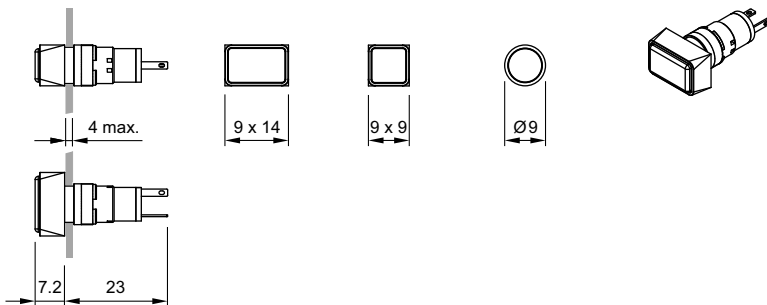

### 2 Illuminated pushbutton actuator page 5

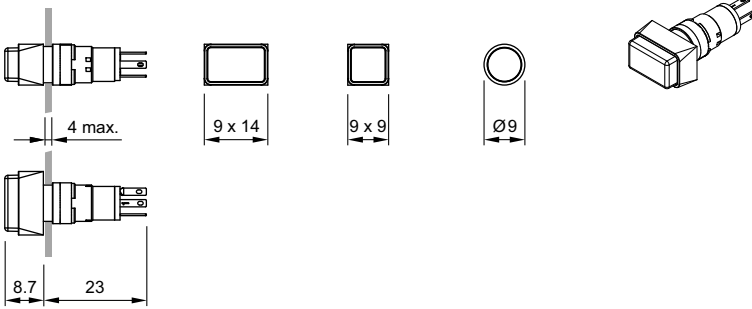

### 3 Indicator actuator, flush mounting page 6

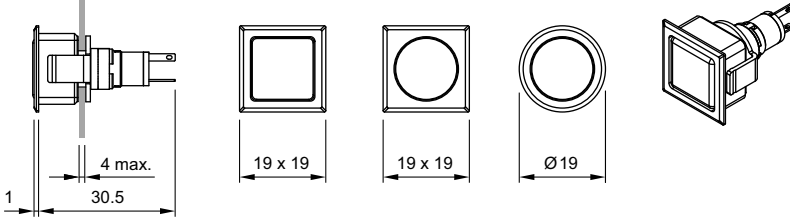

### 4 Illuminated pushbutton actuator, flush mounting page 6

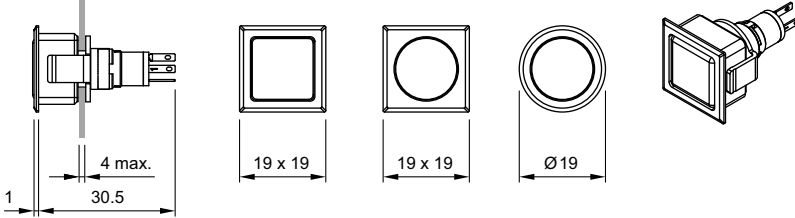

### 5 PCB plug-in base page 8

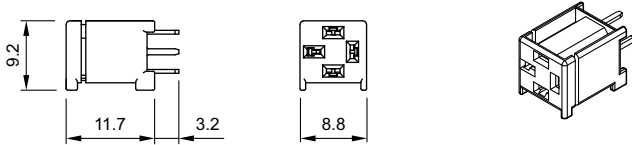

### 6 PCB plug-in base page 8

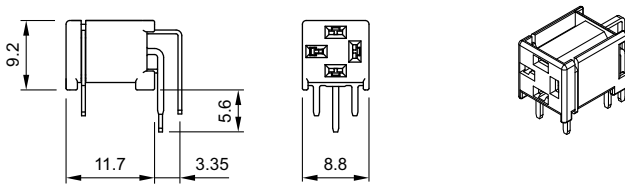

## Circuit drawing

### 1 Indicator page 5 | Indicator actuator, flush mounting page 6



**2 Illuminated pushbutton actuator** page 5 | **Illuminated pushbutton actuator, flush mounting** page 6

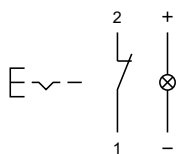

**3 Illuminated pushbutton actuator** page 5 | **Illuminated pushbutton actuator, flush mounting** page 6

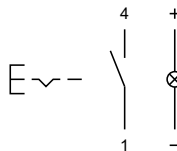

**4 Illuminated pushbutton actuator** page 5 | **Illuminated pushbutton actuator, flush mounting** page 6

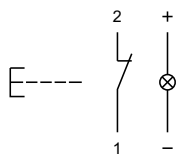

**5 Illuminated pushbutton actuator** page 5 | **Illuminated pushbutton actuator, flush mounting** page 6

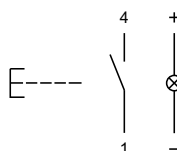

# Index from Typ-Nr.

Typ-Nr.	Page	Typ-Nr.	Page	Typ-Nr.	Page
18-030.0052	5	18-287.035	6		
18-030.0054	5	18-288.035	6		
18-030.0055	5	18-910	8		
18-031.0052	5	18-920.1	8		
18-031.0054	5	18-920.2	8		
18-031.0055	5	18-920.3	8		
18-032.0052	5	18-931.2	7		
18-032.0054	5	18-931.4	7		
18-032.0055	5	18-931.5	7		
18-040.0052	5	18-932.0	7		
18-040.0054	5	18-932.2	7		
18-040.0055	5	18-932.4	7		
18-041.0052	5	18-932.5	7		
18-041.0054	5	18-932.8	7		
18-041.0055	5	18-932.9	7		
18-042.0052	5	18-941.2	7		
18-042.0054	5	18-941.4	7		
18-042.0055	5	18-941.5	7		
18-050.0052	5	18-942.0	7		
18-050.0054	5	18-942.2	7		
18-050.0055	5	18-942.4	7		
18-051.0052	5	18-942.5	7		
18-051.0054	5	18-942.8	7		
18-051.0055	5	18-942.9	7		
18-052.0052	5	18-945	8		
18-052.0054	5	18-946	8		
18-052.0055	5	18-951.2	7		
18-060.0052	6	18-951.4	7		
18-060.0054	6	18-951.5	7		
18-060.0055	6	18-952.0	7		
18-061.0052	6	18-952.2	7		
18-061.0054	6	18-952.4	7		
18-061.0055	6	18-952.5	7		
18-062.0052	6	18-952.8	7		
18-062.0054	6	18-952.9	7		
18-062.0055	6	18-961.2	7		
18-080.0052	6	18-961.4	7		
18-080.0054	6	18-961.5	7		
18-080.0055	6	18-962.0	7		
18-081.0052	6	18-962.2	7		
18-081.0054	6	18-962.4	7		
18-081.0055	6	18-962.5	7		
18-082.0052	6	18-962.8	7		
18-082.0054	6	18-962.9	7		
18-082.0055	6	18-981.2	7		
18-137.035	5	18-981.4	7		
18-138.035	5	18-981.5	7		
18-147.035	5	18-982.0	7		
18-148.035	5	18-982.2	7		
18-157.035	5	18-982.4	7		
18-158.035	5	18-982.5	7		
18-167.035	6	18-982.8	7		
18-168.035	6	18-982.9	7		
18-187.035	6	19-905	9		
18-188.035	6	19-948.0	8		
18-237.035	5	19-949.0	8		
18-238.035	5				
18-247.035	5				
18-248.035	5				
18-257.035	5				
18-258.035	5				
18-267.035	6				
18-268.035	6				