

Enhanced 50 Series™ Photoelectric Sensors

Contents

Overview	1
Model Selection, Sensors	2
Model Selection, Compatible Connector Cables	7
Model Selection, Fiber Optic Cables	8
Model Selection, Accessories	12
Wiring Diagrams	13
Specifications	13
Dimensions	14

The new Enhanced versions of the Cutler-Hammer® 50 Series™ Photoelectric Sensors from Eaton's electrical business offer flexibility, durability and high optical performance in a cost-effective self-contained package. Choose from three output types, four time delay functions, six sensing modes and four connection styles to tailor the sensor to exactly meet your needs.

Sensors are available in thru-beam, reflex, polarized reflex, diffuse reflective, clear object, and fiber optic sensing modes. Brackets are available for easy mounting and to allow precise adjustment of sensor alignment.

Approvals

- CSA Approved
- Certified to UL Standard, UL 508



Unless otherwise noted, the products contained in this document are not designed or intended for use in human safety applications.

High Performance Sensors for Demanding Applications

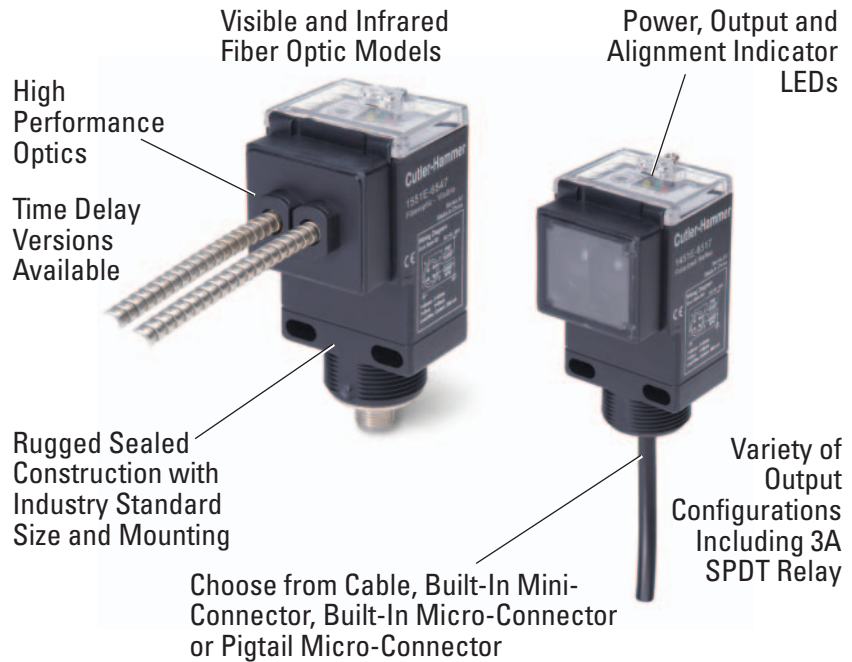

Product Features

- High optical performance models including a 500-foot (152m) Thru-Beam and a 10-foot (3m) Diffuse Reflective unit
- Output options include a 3 Amp SPDT relay
- All units offer light/dark selection
- Logic options include ON-delay, OFF-delay and One-Shot delay
- Fiber optic sensors operate in thru-beam or diffuse reflective mode depending on the fiber optic cable selected
- Fully potted construction for use in areas subject to washdown, high shock and/or vibration
- Choice of pre-wired power cable, built-in mini-connector, built-in micro-connector and pigtail micro-connector versions. Standard pre-wired cable length is 6 feet (1.8m)
- Variety of brackets available including ball swivel

Connection Options



For Customer Service in the U.S. call 1-877-ETN CARE (386-2273),
in Canada call 1-800-268-3578.
For Application Assistance in the U.S. and Canada
call 1-800-426-9184.

June 2008

Model Selection — Sensors

	Voltage Range	Sensing Range	Optimum Range	Sensing Beam	Thru-Beam Component	Output Type	Time Delay	Connection Type	Catalog Number
<p>Thru-Beam Standard Range ①</p>  <p>Field of View: 2.4°</p> <p>For a complete system, order one Sensor and one Detector</p>	10 – 40V DC	200 ft. (61m)	0.1 – 100 ft. (0.03 – 31m)	Infrared	Source	N/A	N/A	6-foot Cable	1150E-6517
					Detector	NPN/PNP 250 mA	no		1250E-6517
							yes		1250E-8517
					Source	N/A	N/A	4-pin Euro (Micro) Connector	1150E-6547 ☉
					Detector	NPN/PNP 250 mA	no		1250E-6547 ☉
							yes		1250E-8547 ☉
					Source	N/A	N/A	4-pin Euro (Micro) Connector (pigtail)	1150E-6537 ☉
					Detector	NPN/PNP 250 mA	no		1250E-6537 ☉
							yes		1250E-8537 ☉
					Source	N/A	N/A	4-pin Mini-Connector	1150E-6507 ☉
					Detector	NPN/PNP 250 mA	no		1250E-6507 ☉
							yes		1250E-8507 ☉
	Source	N/A	N/A	6-foot Cable	1150E-6513				
	Detector	Isolated Output Solid-State Relay 300 mA @ 240V AC/DC	no		1250E-6513				
			yes		1250E-8513				
	Detector	SPDT EM Relay 3A @ 120V AC	no		1250E-6514				
			yes	1250E-8514					
	Source	N/A	N/A	4-pin Micro Connector	1150E-6543 ☉				
	Detector	Isolated Output Solid-State Relay 300 mA @ 240V AC/DC	no		1250E-6543 ☉				
			yes		1250E-8543 ☉				
	Detector	Non-isolated Output Solid-State Relay 300 mA @ 240V AC/DC	no		1250E-6545 ☉				
			yes	1250E-8545 ☉					
	Source	N/A	N/A	4-pin Micro Connector (pigtail)	1150E-6534 ☉				
	Detector	Isolated Output Solid-State Relay 300 mA @ 240V AC/DC	no		1250E-6533 ☉				
yes			1250E-8533 ☉						
Detector	SPDT EM Relay 3A @ 120V AC	no	5-pin Micro Connector (pigtail)	1250E-6534 ☉					
		yes	1250E-8534 ☉						
Source	N/A	N/A	4-pin Mini-Connector	1150E-6504 ☉					
Detector	Isolated Output Solid-State Relay 300 mA @ 240V AC/DC	no		1250E-6503 ☉					
		yes		1250E-8503 ☉					
Detector	SPDT EM Relay 3A @ 120V AC	no	5-pin Mini-Connector	1250E-6504 ☉					
		yes	1250E-8504 ☉						

① For brackets compatible with these sensors, see Accessories on Page 12.

☉☉ See listing of compatible connector cables on Page 7.

☐ Stocked product, typical order quantities guaranteed in stock.

Model Selection — Sensors (Continued)

	Voltage Range	Sensing Range	Optimum Range	Sensing Beam	Thru-Beam Component	Output Type	Time Delay	Connection Type	Catalog Number
Thru-Beam Extended Range ①  Field of View: 2.4° For a complete system, order one Sensor and one Detector	10 – 40V DC	500 ft. (152m)	0.1 – 250 ft. (0.03 – 77m)	Infrared	Source	N/A	N/A	6-foot Cable	1151E-6517
					Detector	NPN/PNP 250 mA	no		1251E-6517
							yes		1251E-8517
					Source	N/A	N/A	4-pin Euro (Micro) Connector	1151E-6547 ⊕
					Detector	NPN/PNP 250 mA	no		1251E-6547 ⊕
							yes		1251E-8547 ⊕
					Source	N/A	N/A	4-pin Euro (Micro) Connector (pigtail)	1151E-6537 ⊕
					Detector	NPN/PNP 250 mA	no		1251E-6537 ⊕
							yes		1251E-8537 ⊕
					Source	N/A	N/A	4-pin Mini-Connector	1151E-6507 ⊕
					Detector	NPN/PNP 250 mA	no		1251E-6507 ⊕
							yes		1251E-8507 ⊕
					Source	N/A	N/A	6-foot Cable	1151E-6513
					Detector	Isolated Output Solid-State Relay 300 mA @ 240V AC/DC	no		1251E-6513
	yes	1251E-8513							
	SPDT EM Relay 3A @ 120V AC	no	1251E-6514						
	yes	1251E-8514							
	Source	N/A	N/A	4-pin Micro Connector	1151E-6543 ⊕				
	Detector	Isolated Output Solid-State Relay 300 mA @ 240V AC/DC	no		1251E-6543 ⊕				
			yes		1251E-8543 ⊕				
			Non-isolated Output Solid-State Relay 300 mA @ 240V AC/DC		no	1251E-6545 ⊕			
	yes	1251E-8545 ⊕							
	Source	N/A	N/A	4-pin Micro Connector (pigtail)	1151E-6534 ⊕				
	Detector	Isolated Output Solid-State Relay 300 mA @ 240V AC/DC	no		1251E-6533 ⊕				
			yes		1251E-8533 ⊕				
	SPDT EM Relay 3A @ 120V AC	no	5-pin Micro Connector (pigtail)	1251E-6534 ⊕					
		yes	1251E-8534 ⊕						
	Source	N/A	N/A	4-pin Mini-Connector	1151E-6504 ⊕				
Detector	Isolated Output Solid-State Relay 300 mA @ 240V AC/DC	no	1251E-6503 ⊕						
		yes	1251E-8503 ⊕						
SPDT EM Relay 3A @ 120V AC	no	5-pin Mini-Connector	1251E-6504 ⊕						
	yes	1251E-8504 ⊕							

① For brackets compatible with these sensors, see Accessories on Page 12.



⊕⊕ See listing of compatible connector cables on Page 7.

□ Fast turn product with typical one business day lead-time to shipment.

■ Stocked product, typical order quantities guaranteed in stock.

June 2008

Model Selection — Sensors (Continued)

	Voltage Range	Sensing Range ①	Optimum Range ①	Sensing Beam	Output Type	Time Delay	Connection Type	Catalog Number		
 <p>Standard Reflex ③</p> <p><i>Field of View: 1.0°</i></p> <p>For a complete system, order one Sensor and one Retroreflector (see PG.05E.17.T.E)</p>	10 – 40V DC	30 ft. (9m)	0.5 – 15 ft. (0.2 – 4.6m)	Visible Red	NPN/PNP 250 mA	no	6-foot Cable	1450E-6517		
						yes		1450E-8517		
						no	4-pin Euro (Micro) Connector	1450E-6547 ⊕		
						yes		1450E-8547 ⊕		
						no	4-pin Euro (Micro) Connector (pigtail)	1450E-6537 ⊕		
						yes		1450E-8537 ⊕		
						no	4-pin Mini-Connector	1450E-6507 ⊕		
						yes		1450E-8507 ⊕		
						12 – 240V DC 24 – 240V AC	Isolated Output Solid-State Relay 300 mA @ 240V AC/DC	no	6-foot Cable	1450E-6513
								yes		1450E-8513
	no	4-pin Micro Connector	1450E-6543 ⊕							
	yes		1450E-8543 ⊕							
	no	4-pin Micro Connector (pigtail)	1450E-6533 ⊕							
	yes		1450E-8533 ⊕							
	no	4-pin Mini-Connector	1450E-6503 ⊕							
	yes		1450E-8503 ⊕							
	Non-isolated Output Solid-State Relay 300 mA @ 240V AC/DC	no	4-pin Micro Connector	1450E-6545 ⊕						
		yes		1450E-8545 ⊕						
	SPDT EM Relay 3A @ 120V AC	no	6-foot Cable	1450E-6514						
		yes		1450E-8514						
no		5-pin Micro Connector (pigtail)	1450E-6534 ⊕							
yes			1450E-8534 ⊕							
no		5-pin Mini-Connector	1450E-6504 ⊕							
yes			1450E-8504 ⊕							
 <p>Polarized Reflex ②③</p> <p><i>Field of View: 1.0°</i></p> <p>For a complete system, order one Sensor and one Retroreflector (see PG.05E.17.T.E)</p>	10 – 40V DC	16 ft. (4.9m)	0.5 – 8 ft. (0.2 – 2.5m)	Visible Red	NPN/PNP 250 mA	no	6-foot Cable	1451E-6517		
						yes		1451E-8517		
						no	4-pin Euro (Micro) Connector	1451E-6547 ⊕		
						yes		1451E-8547 ⊕		
						no	4-pin Euro (Micro) Connector (pigtail)	1451E-6537 ⊕		
						yes		1451E-8537 ⊕		
						no	4-pin Mini-Connector	1451E-6507 ⊕		
						yes		1451E-8507 ⊕		
						12 – 240V DC 24 – 240V AC	Isolated Output Solid-State Relay 300 mA @ 240V AC/DC	no	6-foot Cable	1451E-6513
								yes		1451E-8513
	no	4-pin Micro Connector	1451E-6543 ⊕							
	yes		1451E-8543 ⊕							
	no	4-pin Micro Connector (pigtail)	1451E-6533 ⊕							
	yes		1451E-8533 ⊕							
	no	4-pin Mini-Connector	1451E-6503 ⊕							
	yes		1451E-8503 ⊕							
	Non-isolated Output Solid-State Relay 300 mA @ 240V AC/DC	no	4-pin Micro Connector	1451E-6545 ⊕						
		yes		1451E-8545 ⊕						
	SPDT EM Relay 3A @ 120V AC	no	6-foot Cable	1451E-6514						
		yes		1451E-8514						
no		5-pin Micro Connector (pigtail)	1451E-6534 ⊕							
yes			1451E-8534 ⊕							
no		5-pin Mini-Connector	1451E-6504 ⊕							
yes			1451E-8504 ⊕							

① Ranges based on 3-inch retroreflector for reflex sensors.

② Polarized sensors may not operate with reflective tape. Test tape selection before installation.

③ For brackets compatible with these sensors, see Accessories on **Page 12**.

⊕ ⊗ See listing of compatible connector cables on **Page 7**.

■ Stocked product, typical order quantities guaranteed in stock.

Model Selection — Sensors (Continued)

	Voltage Range	Sensing Range ①	Optimum Range ①	Sensing Beam	Output Type	Time Delay	Connection Type	Catalog Number				
Diffuse Reflective ②  Field of View: 2.8°	10 – 40V DC	5 ft. (1.5m)	1 – 30 in. (25 – 760 mm)	Infrared	NPN/PNP 250 mA	no	6-foot Cable	1350E-6517				
						yes		1350E-8517				
						no	4-pin Euro (Micro) Connector	1350E-6547 ☼				
						yes		1350E-8547 ☼				
						no	4-pin Euro (Micro) Connector (pigtail)	1350E-6537 ☼				
						yes		1350E-8537 ☼				
					no	4-pin Mini-Connector	1350E-6507 ☼					
					yes		1350E-8507 ☼					
					12 – 240V DC 24 – 240V AC	5 ft. (1.5m)	1 – 30 in. (25 – 760 mm)	Infrared	Isolated Output Solid-State Relay 300 mA @ 240V AC/DC	no	6-foot Cable	1350E-6513
										yes		1350E-8513
	no	4-pin Micro Connector	1350E-6543 ☼									
	yes		1350E-8543 ☼									
	no	4-pin Micro Connector (pigtail)	1350E-6533 ☼									
	yes		1350E-8533 ☼									
	no	4-pin Mini-Connector	1350E-6503 ☼									
	yes		1350E-8503 ☼									
	10 – 40V DC	10 ft. (3m)	1 – 60 in. (25 – 1520 mm)	Infrared	NPN/PNP 250 mA	no	6-foot Cable	1351E-6517				
						yes		1351E-8517				
						no	4-pin Euro (Micro) Connector	1351E-6547 ☼				
						yes		1351E-8547 ☼				
no						4-pin Euro (Micro) Connector (pigtail)	1351E-6537 ☼					
yes							1351E-8537 ☼					
no	4-pin Mini-Connector	1351E-6507 ☼										
yes		1351E-8507 ☼										
12 – 240V DC 24 – 240V AC	10 ft. (3m)	1 – 60 in. (25 – 1520 mm)	Infrared	Isolated Output Solid-State Relay 300 mA @ 240V AC/DC	no	6-foot Cable	1351E-6513					
					yes		1351E-8513					
					no	4-pin Micro Connector	1351E-6543 ☼					
					yes		1351E-8543 ☼					
					no	4-pin Micro Connector (pigtail)	1351E-6533 ☼					
					yes		1351E-8533 ☼					
no	4-pin Mini-Connector	1351E-6503 ☼										
yes		1351E-8503 ☼										
10 – 40V DC	10 ft. (3m)	1 – 60 in. (25 – 1520 mm)	Infrared	Non-isolated Output Solid-State Relay 300 mA @ 240V AC/DC	no	4-pin Micro Connector	1351E-6545 ☼					
					yes		1351E-8545 ☼					
					12 – 240V DC 24 – 240V AC	10 ft. (3m)	1 – 60 in. (25 – 1520 mm)	Infrared	SPDT EM Relay 3A @ 120V AC	no	6-foot Cable	1351E-6514
										yes		1351E-8514
										no	5-pin Micro Connector (pigtail)	1351E-6534 ☼
										yes		1351E-8534 ☼
no	5-pin Mini-Connector	1351E-6504 ☼										
yes		1351E-8504 ☼										

① Ranges based on 90% reflectance white card for diffuse reflective sensors.

② For brackets compatible with these sensors, see Accessories on Page 12.



☼☼ See listing of compatible connector cables on Page 7.

☼ Fast turn product with typical one business day lead-time to shipment.

☼ Stocked product, typical order quantities guaranteed in stock.

June 2008

Model Selection — Sensors (Continued)

	Voltage Range	Sensing Range	Optimum Range	Sensing Beam	Output Type	Time Delay	Connection Type	Catalog Number	
 <p>Clear Object Detector ①②</p> <p><i>Field of View: 0.68°</i></p> <p>For a complete system, order one Sensor and one Retroreflector (see PG.05E.17.T.E)</p>	10 – 40V DC	45 in. (1.2m)	1 – 24 in. (25 – 610 mm)	Visible Red	NPN/PNP 250 mA	no	6-foot Cable	1452E-6517	
	yes					1452E-8517			
	no					4-pin Euro (Micro) Connector	1452E-6547 ⊕		
	yes						1452E-8547 ⊕		
	no					4-pin Euro (Micro) Connector (pigtail)	1452E-6537 ⊕		
	yes						1452E-8537 ⊕		
	no					4-pin Mini-Connector	1452E-6507 ⊕		
	yes						1452E-8507 ⊕		
	12 – 240V DC 24 – 240V AC					Isolated Output Solid-State Relay 300 mA @ 240V AC/DC	no	6-foot Cable	1452E-6513
							yes	6-foot Cable	1452E-8513
					no		4-pin Micro Connector	1452E-6543 ⊕	
					yes		4-pin Micro Connector	1452E-8543 ⊕	
					no		4-pin Micro Connector (pigtail)	1452E-6533 ⊕	
					yes		4-pin Micro Connector (pigtail)	1452E-8533 ⊕	
					no		4-pin Mini-Connector	1452E-6503 ⊕	
					yes		4-pin Mini-Connector	1452E-8503 ⊕	
					Non-isolated Output Solid-State Relay 300 mA @ 240V AC/DC		no	4-pin Micro Connector	1452E-6545 ⊕
							yes	4-pin Micro Connector	1452E-8545 ⊕
	SPDT EM Relay 3A @ 120V AC				no	6-foot Cable	1452E-6514		
							1452E-8514		
no		5-pin Micro Connector (pigtail)	1452E-6534 ⊕						
			1452E-8534 ⊕						
no		5-pin Mini-Connector	1452E-6504 ⊕						
			1452E-8504 ⊕						
 <p>Fiber Optic Infrared ①</p> <p><i>Field of View: Depends on fiber selected</i></p> <p>For a complete system, order one Sensor and one Fiber Optic Cable (see Pages 8 and 9)</p> <p>Infrared Fiber Optic Sensors are compatible with Glass Fiber Optic Cables</p>	10 – 40V DC	Depends on fiber selected ③	Depends on fiber selected	Infrared	NPN/PNP 250 mA	no	6-foot Cable	1550E-6517	
	yes					1550E-8517			
	no					4-pin Euro (Micro) Connector	1550E-6547 ⊕		
	yes						1550E-8547 ⊕		
	no					4-pin Euro (Micro) Connector (pigtail)	1550E-6537 ⊕		
	yes						1550E-8537 ⊕		
	no					4-pin Mini-Connector	1550E-6507 ⊕		
	yes						1550E-8507 ⊕		
	12 – 240V DC 24 – 240V AC					Isolated Output Solid-State Relay 300 mA @ 240V AC/DC	no	6-foot Cable	1550E-6513
							yes	6-foot Cable	1550E-8513
no					4-pin Micro Connector		1550E-6543 ⊕		
yes					4-pin Micro Connector		1550E-8543 ⊕		
no					4-pin Micro Connector (pigtail)		1550E-6533 ⊕		
yes					4-pin Micro Connector (pigtail)		1550E-8533 ⊕		
no					4-pin Mini-Connector		1550E-6503 ⊕		
yes					4-pin Mini-Connector		1550E-8503 ⊕		
Non-isolated Output Solid-State Relay 300 mA @ 240V AC/DC					no		4-pin Micro Connector	1550E-6545 ⊕	
					yes		4-pin Micro Connector	1550E-8545 ⊕	
SPDT EM Relay 3A @ 120V AC	no				6-foot Cable	1550E-6514			
						1550E-8514			
	no	5-pin Micro Connector (pigtail)	1550E-6534 ⊕						
			1550E-8534 ⊕						
	no	5-pin Mini-Connector	1550E-6504 ⊕						
			1550E-8504 ⊕						

① For brackets compatible with these sensors, see Accessories on **Page 12**.

② Contact Eaton's Cutler-Hammer Sensors Applications Support at 800-426-9184 for information on availability of these models.

③ Diffuse mode — up to 6 inches (152 mm); Thru-beam — up to 35 inches (890 mm).

⊕ ⊕ See listing of compatible connector cables on **Page 7** and **Pages 8 and 9**.

□ Fast turn product with typical one business day lead-time to shipment.

■ Stocked product, typical order quantities guaranteed in stock.

Model Selection — Sensors (Continued)

	Voltage Range	Sensing Range	Optimum Range	Sensing Beam	Output Type	Time Delay	Connection Type	Catalog Number							
 <p>Field of View: Depends on fiber selected</p> <p>For a complete system, order one Sensor and one Fiber Optic Cable (see Page 10)</p> <p>Visible Fiber Optic Sensors are compatible with Plastic Fiber Optic Cables only</p>	10 – 40V DC	Depends on fiber selected ②	Depends on fiber selected	Visible Red	NPN/PNP 250 mA	no	6-foot Cable	1551E-6517							
						yes		1551E-8517							
						no	4-pin Euro (Micro) Connector	1551E-6547 ⊕							
						yes		1551E-8547 ⊕							
						no	4-pin Euro (Micro) Connector (pigtail)	1551E-6537 ⊕							
						yes		1551E-8537 ⊕							
						no	4-pin Mini-Connector	1551E-6507 ⊕							
						yes		1551E-8507 ⊕							
						12 – 240V DC 24 – 240V AC					Isolated Output Solid-State Relay 300 mA @ 240V AC/DC	no	6-foot Cable	1551E-6513	
												yes		1551E-8513	
	no	4-pin Micro Connector	1551E-6543 ⊕												
	yes		1551E-8543 ⊕												
	no	4-pin Micro Connector (pigtail)	1551E-6533 ⊕												
	yes		1551E-8533 ⊕												
	no	4-pin Mini-Connector	1551E-6503 ⊕												
	yes		1551E-8503 ⊕												
	Non-isolated Output Solid-State Relay 300 mA @ 240V AC/DC												no	4-pin Micro Connector	1551E-6545 ⊕
													yes		1551E-8545 ⊕
						SPDT EM Relay 3A @ 120V AC							no	6-foot Cable	1551E-6514
													yes		1551E-8514
no													5-pin Micro Connector (pigtail)	1551E-6534 ⊕	
yes														1551E-8534 ⊕	
no	5-pin Mini-Connector	1551E-6504 ⊕													
yes		1551E-8504 ⊕													

① For brackets compatible with these sensors, see Accessories on Page 12.
 ② Diffuse mode — up to 3 inches (76 mm); Thru-beam — up to 35 inches (890 mm).



Fast turn product with typical one business day lead-time to shipment.
 Stocked product, typical order quantities guaranteed in stock.

⊕ See listing of compatible connector cables on Page 10.

Model Selection — Compatible Connector Cables ③



	Voltage Style	Number of Pins	Gauge	Length	Catalog Number			Pin Configuration/Wire Colors (Face View Female Shown)
					PVC Jacket	PUR Jacket	IRR PUR Jacket	

Standard Cables — Micro Style

	AC Micro	4-pin 4-wire	22 AWG	6.0 feet (2m)	CSAS4F4CY2202	CSAS4F4RY2202	CSAS4F4IO2202	 1-Red/Black 2-Red/White 3-Red 4-Green
		5-pin 5-wire						CSAS5A5CY2202
	DC	4-pin 4-wire	22 AWG	6.0 feet (2m)	CSDS4A4CY2202	CSDS4A4RY2202	CSDS4A4IO2202	 1-Brown 2-White 3-Blue 4-Black

	Voltage Style	Number of Pins	Gauge	Length	Catalog Number	Pin Configuration/Wire Colors (Face View Female Shown)
--	---------------	----------------	-------	--------	----------------	--









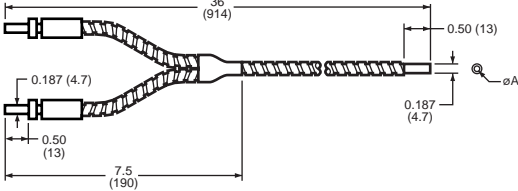

Standard Cables — Mini Style

 <p>Current Rating @ 600V 3-pin: 10A 4-pin: 8A</p>	AC/DC	4-pin, 4-wire	16 AWG	6 feet (2m)	CSMS4A4CY1602		 1-Black 2-Blue 3-Brown 4-White
		5-pin, 5-wire					16 AWG

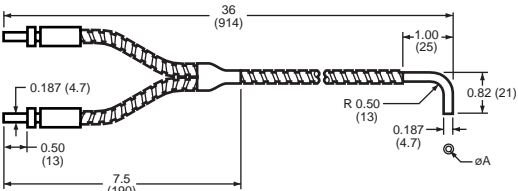
③ For a full selection of connector cables, see PG.05.05.T.E.
 Stocked product, typical order quantities guaranteed in stock.

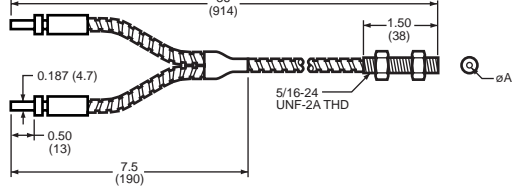

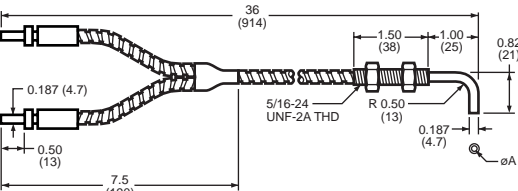

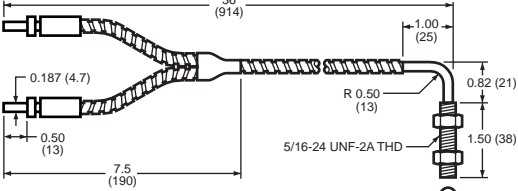



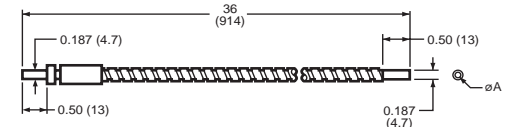

June 2008

Model Selection — Glass Fiber Optic Cables — Duplex Cables (for Diffuse Reflective Sensing)

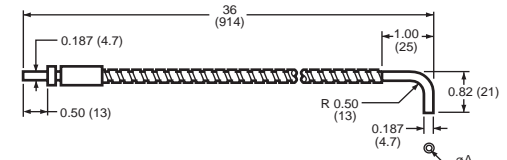
	Fiber Bundle Size A in Inches (mm)	Catalog Number		Approximate Dimensions in Inches (mm) — Stainless Steel Jacket Pictured 
		Stainless Steel Jacket	PVC/Monocoil Jacket	
Forward Viewing, Unthreaded 	0.125 (3.2)	E51KE713	E51KE313	
Right-Angle Viewing, Unthreaded 	0.125 (3.2)	E51KE733	E51KE333	
Forward Viewing, Threaded Cable End 	0.125 (3.2)	E51KE723	E51KE323	
Right-Angle Viewing, Threaded Cable Shaft 	0.125 (3.2)	E51KE7A3	E51KE3A3	
Right-Angle Viewing, Threaded Cable End 	0.125 (3.2)	E51KE7B3	E51KE3B3	

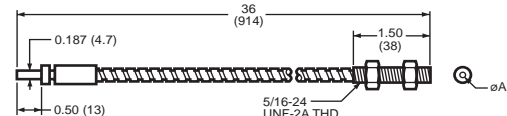
 Stocked product, typical order quantities guaranteed in stock.

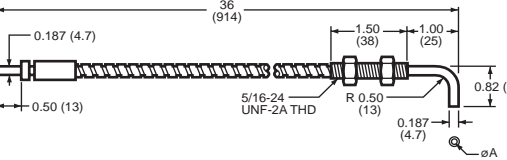

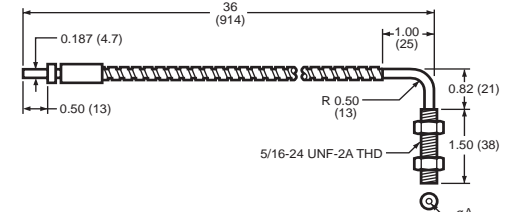
Model Selection — Glass Fiber Optic Cables — Single Cables (for Thru-Beam Sensing)

	Fiber Bundle Size A in Inches (mm)	Catalog Number		Approximate Dimensions in Inches (mm) — Stainless Steel Jacket Pictured  Collar Mounting End
		Stainless Steel Jacket	PVC/Monocoil Jacket	
Forward Viewing, Unthreaded 	0.125 (3.2)	E51KE813	E51KE413	
Right-Angle Viewing, Unthreaded 	0.125 (3.2)	E51KE833	E51KE433	
Forward Viewing, Threaded Cable End 	0.125 (3.2)	E51KE823	E51KE423	
Right-Angle Viewing, Threaded Cable Shaft 	0.125 (3.2)	E51KE8A3	E51KE4A3	
Right-Angle Viewing, Threaded Cable End 	0.125 (3.2)	E51KE8B3	E51KE4B3	

Stocked product, typical order quantities guaranteed in stock.

June 2008

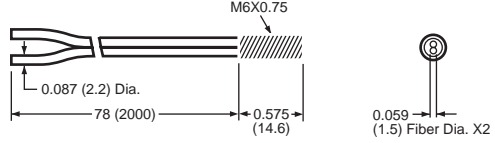

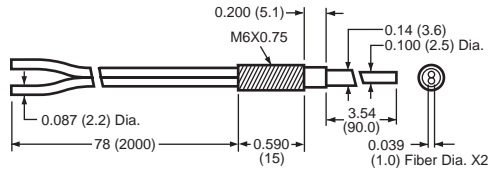
Model Selection — Plastic Fiber Optic Cables — Pre-assembled Duplex Cables

	Fiber Diameter in Inches (mm)	Catalog Number	Approximate Dimensions in Inches (mm)
	0.059 (1.5)	6324E-6501 ①	
	0.039 (1.0)	6324E-6502	

① Larger diameter (1.5 mm) fibers provide approximately 50% longer sensing range than small diameter (1 mm).

■ Stocked product, typical order quantities guaranteed in stock.

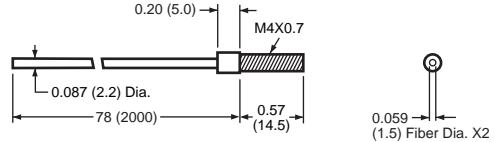
Model Selection — Plastic Fiber Optic Cables — Pre-assembled Single Cables

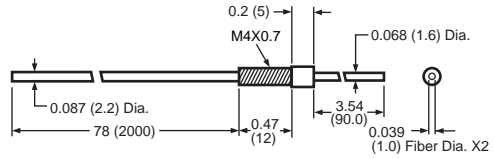
	Fiber Diameter in Inches (mm)	Catalog Number	Approximate Dimensions in Inches (mm)
	0.059 (1.5)	6323E-6501 ②	
	0.039 (1.0)	6323E-6502	

② Larger diameter (1.5 mm) fibers provide approximately 50% longer sensing range than small diameter (1 mm).

■ Stocked product, typical order quantities guaranteed in stock.

Excess Gain

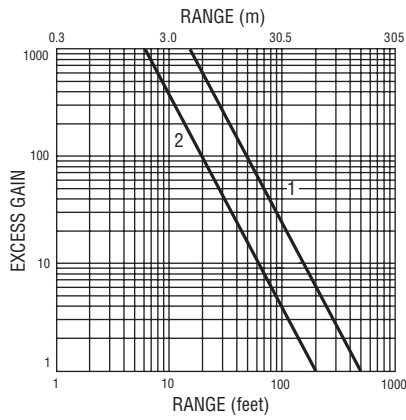

Thru-Beam:
1. 1151E/1251E
2. 1150E/1250E

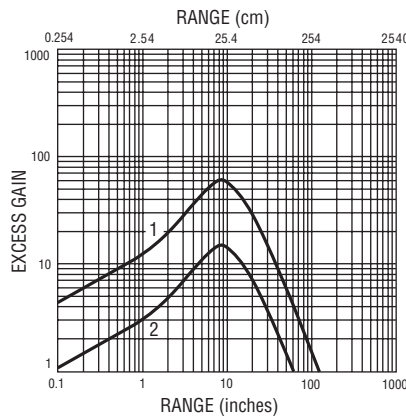

Diffuse Reflective
90% Reflectance White Card:
1. 1351E
2. 1350E

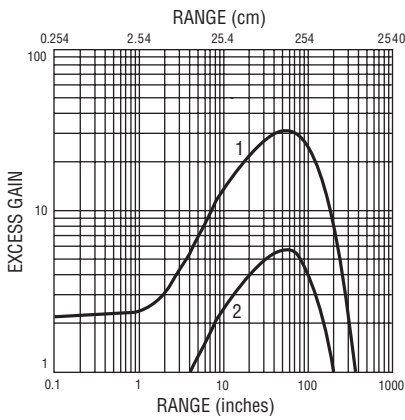

Reflex
3" Retroreflector:
1. 1450E
2. 1451E

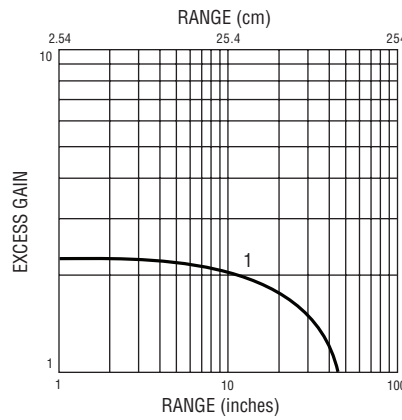

Clear Object Detector
3" Retroreflector:
1. 1452E

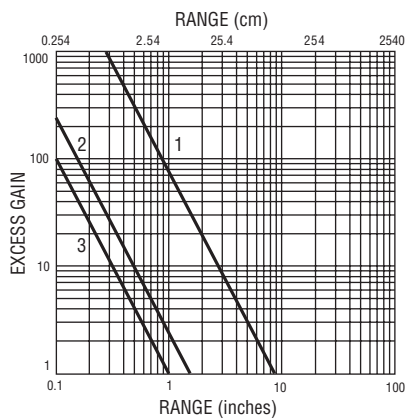



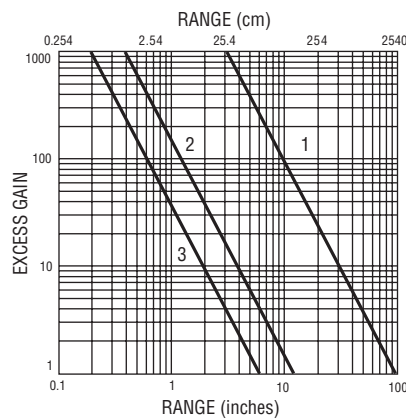

Fiber Optic Diffuse
0.125" Dia. Glass Fiber: 0.040" Dia. Plastic Fiber:
1. 1550E 3. 1551E
2. 1551E

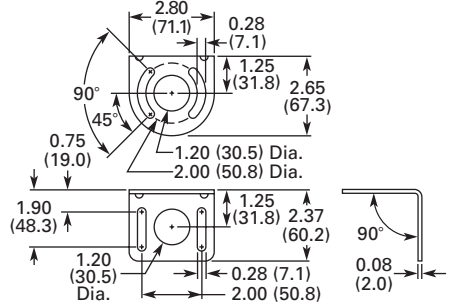

Fiber Optic Thru-Beam
0.125" Dia. Glass Fiber: 0.040" Dia. Plastic Fiber:
1. 1550E 3. 1551E
2. 1551E

June 2008

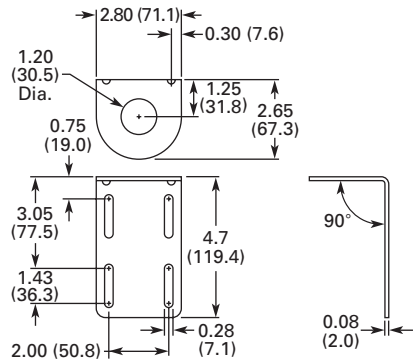
Model Selection — Accessories

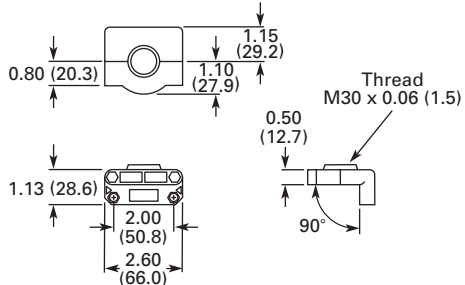
	Description	Catalog Number	Approximate Dimensions in Inches (mm) Except Where Noted
 <p>Mounting Bracket Right Angle — Short</p>	<p>Right Angle Mounting Bracket — Provides for full 360° rotation of sensor. Bracket slots allow for up to 1.5 inches of vertical adjustment. Nickel Plated</p>	6150E-6501	
 <p>Mounting Bracket Right Angle — Tall</p>	<p>Right Angle Mounting Bracket — Provides for full 360° rotation of sensor. Bracket slots allow for up to 1.5 inches of vertical adjustment in each slot, and 3.5 inches of overall positioning adjustment.</p>	6150E-6502	
 <p>Mounting Bracket Ball Swivel</p>	<p>Right Angle Mounting Bracket with Ball Swivel — Provides for full 360° rotation of sensor. Ball swivel allows for ±30° sensor angle.</p>	6150E-6503	
Retroreflectors	Retroreflectors and retroreflective tape	See PG.05E.17.T.E	
Connector Cables	For use with connector version sensors	See PG.05.05.T.E	

Stocked product, typical order quantities guaranteed in stock.

Wiring Diagrams (Pin numbers are for reference only, rely on pin location when wiring)

Operating Voltage	Models	Cable Models	Mini-Connector Models (Face View Male Shown)	Micro-Connector Models (Face View Male Shown)
10 – 40V DC	Thru-Beam Source			
	All others			
12 – 240V DC or 24 – 240V AC	Thru-Beam Source			
	Solid-State Relay ③			
	All others with Isolated AC/DC Output			
All others with Non-isolated AC/DC Output				
12 – 240V DC or 24 – 240V AC	Thru-Beam Source			
	SPDT EM Relay ③			

- ① Connect load to appropriate output for either sinking or sourcing operation.
- ② Connecting the Test input to 0V DC allows you to switch the light source off for troubleshooting while leaving the sensor under power.
- ③ Over current protection is to be provided in the field. Conductor size for 20 AWG: 5 amp; 22 AWG: 3 amp; 24 AWG: 2 amp.

Specifications

	AC/DC EM Relay Models	AC/DC Solid-State Relay Models	DC Only Standard Range Models	DC Only Extended Range Models
Input Voltage	12 – 240V DC 24 – 240V AC			10 – 40V DC
Light/Dark Operation	Switch selectable			
Operating Temperature	-13 – 131°F (-25 – 55°C)			
Humidity	95% Relative humidity, non-condensing			
Case Material	Fiberglass reinforced plastic			
Lens Material	Acrylic			

June 2008

Specifications (Continued)

	AC/DC EM Relay Models	AC/DC Solid-State Relay Models	DC Only Standard Range Models	DC Only Extended Range Models
Vibration	IEC 60947-5-2 part 7.4.2			
Shock	IEC 60947-5-2 part 7.4.1			
Protection	Output short circuit and overcurrent protection Reverse polarity protection			
Enclosure Ratings	IP67			
Output Load	3A @ 120V AC 3A @ 240V AC 3A @ 28V AC	300 mA @ 240V AC/ DC	250 mA @ 40V DC	
Response Time	15 mS	2 mS		
Timer Timing Response	0 – 15 sec.			
No Load Current	<30 mA			
Leakage Current (max.)	—	1 mA @ 240V AC	<10 μA	
Indicator LEDs	Green: Output; Yellow: Power; Red: Alignment			
Emitter LED	Diffuse, Infrared Fiber Optic, Thru-Beam Models: Infrared 880 nm Reflex, Polarized Reflex, Clear Object, Visible Fiber Optic Units: Visible Red 660 nm			

Approximate Dimensions in Inches (mm)

Cable and Pigtail Connector Versions

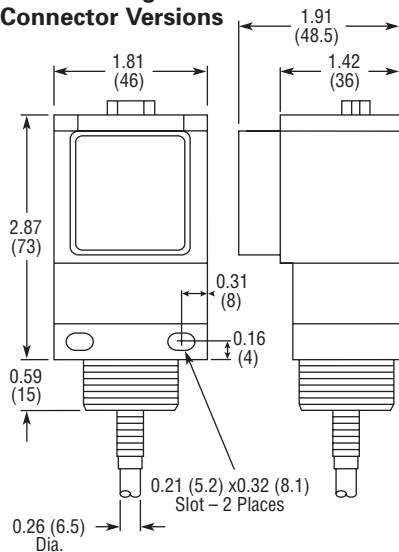

Clear Object Versions

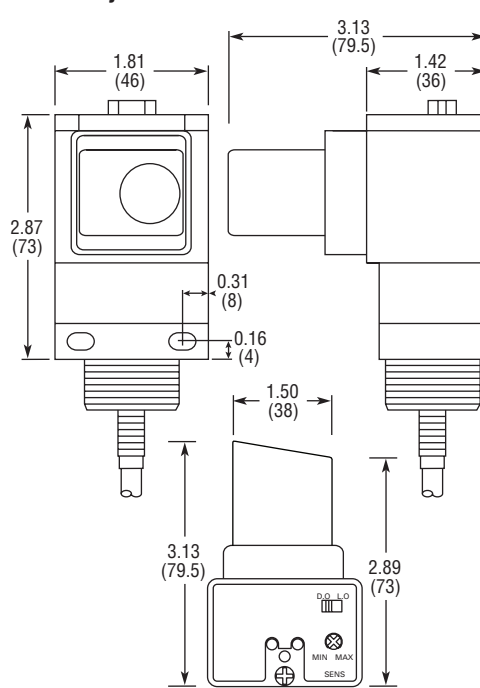

Mini-Connector Versions

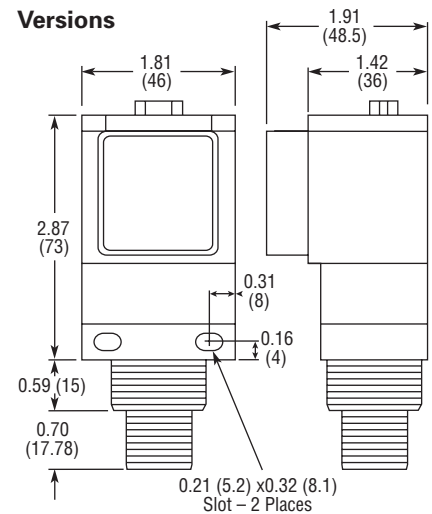

AC/DC Micro or Euro (Micro) Connector Versions

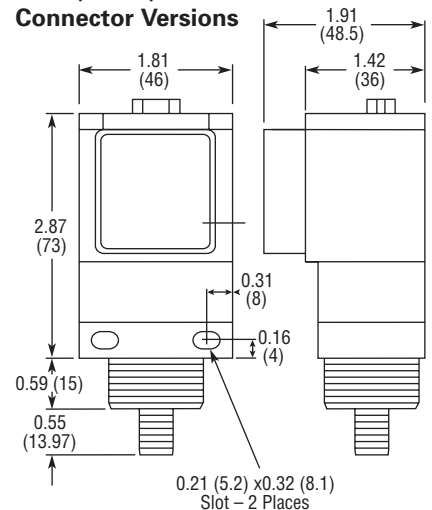

Top View with Timing

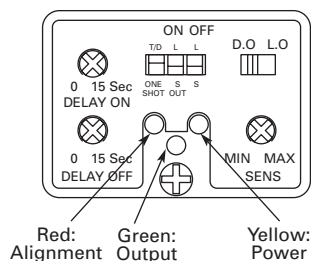

Top View without Timing

