

## Base strip - MSTBVA 2,5/ 8-G-5,08 THT - 1902877

Please be informed that the data shown in this PDF Document is generated from our Online Catalog. Please find the complete data in the user's documentation. Our General Terms of Use for Downloads are valid (<http://phoenixcontact.com/download>)



Header, Nominal current: 12 A, Rated voltage (III/2): 320 V, Number of positions: 8, Pitch: 5.08 mm, Color: black, Contact surface: Tin, Mounting: SMD/THT/THR, User information and design recommendations for through hole reflow technology can be found under "Downloads"



### Key commercial data

Packing unit	50 pc
Minimum order quantity	50 pc
GTIN	 4 017918 187781
Weight per Piece (excluding packing)	3.9 g
Custom tariff number	85366990
Country of origin	Germany
Note	Made to Order (non-returnable)

### Technical data

#### Dimensions

Length	8.6 mm
Pitch	5.08 mm
Dimension a	35.56 mm
Pin dimensions	1 x 1 mm
Hole diameter	1.4 mm

#### General

Range of articles	MSTBVA 2,5/..-G-THT
Insulating material group	IIIa
Rated surge voltage (III/3)	4 kV
Rated surge voltage (III/2)	4 kV
Rated surge voltage (II/2)	4 kV
Rated voltage (III/3)	250 V
Rated voltage (III/2)	320 V
Rated voltage (II/2)	400 V

# Base strip - MSTBVA 2,5/ 8-G-5,08 THT - 1902877

## Technical data

### General

Connection in acc. with standard	EN-VDE
Nominal current I <sub>N</sub>	12 A
Maximum load current	12 A
Insulating material	PA
Inflammability class according to UL 94	V0
Color	black
Number of positions	8

## Classifications

### eCl@ss

eCl@ss 4.0	272607xx
eCl@ss 4.1	27260701
eCl@ss 5.0	27260701
eCl@ss 5.1	27260701
eCl@ss 6.0	27260704
eCl@ss 7.0	27440402
eCl@ss 8.0	27440402

### ETIM

ETIM 3.0	EC001121
ETIM 4.0	EC002637
ETIM 5.0	EC002637

### UNSPSC

UNSPSC 6.01	30211810
UNSPSC 7.0901	39121409
UNSPSC 11	39121409
UNSPSC 12.01	39121409
UNSPSC 13.2	39121409

## Approvals

### Approvals

---

#### Approvals

UL Recognized / VDE Gutachten mit Fertigungsüberwachung / cUL Recognized / IECCE CB Scheme / CCA / EAC / cULus Recognized

---

#### Ex Approvals

---

# Base strip - MSTBVA 2,5/ 8-G-5,08 THT - 1902877

## Approvals

Approvals submitted

### Approval details

UL Recognized 		
	B	D
Nominal current IN	12 A	10 A
Nominal voltage UN	300 V	300 V

VDE Gutachten mit Fertigungsüberwachung 	
Nominal current IN	12 A
Nominal voltage UN	250 V

cUL Recognized 		
	B	D
Nominal current IN	12 A	10 A
Nominal voltage UN	300 V	300 V

IECEE CB Scheme 	
Nominal current IN	12 A
Nominal voltage UN	250 V

CCA	
Nominal current IN	12 A
Nominal voltage UN	250 V

EAC
-----

## Base strip - MSTBVA 2,5/ 8-G-5,08 THT - 1902877

### Approvals

cULus Recognized 

### Accessories

#### Accessories

#### Coding element

Coding star - CR-MSTB - 1734401



Coding section, inserted into the recess in the header or the inverted plug, red insulating material

#### Filler plug

Accessories - MSTB-BL - 1755477



Keying cap, for forming sections, plugs onto header pin, green insulating material

#### Labeled terminal marker

Marker card - SK 5,08/3,8:FORTL.ZAHLEN - 0804293



Marker card, Card, white, labeled, Horizontal: Consecutive numbers 1 - 10, 11 - 20, etc. up to 91 - (99)100, Mounting type: Adhesive, for terminal block width: 5.08 mm, Lettering field: 5.08 x 3.8 mm

#### Additional products

Printed-circuit board connector - SMSTB 2,5/ 8-ST-5,08 - 1826348



Plug component, Nominal current: 12 A, Rated voltage (III/2): 320 V, Number of positions: 8, Pitch: 5.08 mm, Connection method: Screw connection, Color: green, Contact surface: Tin

## Base strip - MSTBVA 2,5/ 8-G-5,08 THT - 1902877

### Accessories

Printed-circuit board connector - FKCT 2,5/ 8-ST-5,08 - 1902178



Plug component, Nominal current: 12 A, Rated voltage (III/2): 320 V, Number of positions: 8, Pitch: 5.08 mm, Connection method: Spring-cage connection, Color: green, Contact surface: Tin

Printed-circuit board connector - MSTBC 2,5/ 8-STZ-5,08 - 1809569



Plug component, Nominal current: 12 A, Rated voltage (III/2): 320 V, Number of positions: 8, Pitch: 5.08 mm, Connection method: Crimp connection, Color: green, Corresponding female crimp contacts with current [A] and conductor cross section range [mm<sup>2</sup>] data: 10A/MSTBC-MT 0,5-1,0 (3190564); 10A/MSTBC-MT 0,5-1,0 BA (3190645); 12A/MSTBC-MT 1,5-2,5 (3190551); 12A/MSTBC-MT 1,5-2,5 BA (3190658). BA = Bandkontakte

Printed-circuit board connector - MVSTBR 2,5/ 8-ST-5,08 - 1792304



Plug component, Nominal current: 12 A, Rated voltage (III/2): 320 V, Number of positions: 8, Pitch: 5.08 mm, Connection method: Screw connection, Color: green, Contact surface: Tin

Base strip - IC 2,5/ 8-G-5,08 - 1786462



Header, Nominal current: 12 A, Rated voltage (III/2): 320 V, Number of positions: 8, Pitch: 5.08 mm, Color: green, Contact surface: Tin, Mounting: Soldering

Base strip - ICV 2,5/ 8-G-5,08 - 1786006



Header, Nominal current: 12 A, Rated voltage (III/2): 320 V, Number of positions: 8, Pitch: 5.08 mm, Color: green, Contact surface: Tin, Mounting: Soldering

## Base strip - MSTBVA 2,5/ 8-G-5,08 THT - 1902877

### Accessories

#### Plug - MSTBT 2,5/ 8-ST-5,08 - 1781043



Plug component, Nominal current: 12 A, Rated voltage (III/2): 320 V, Number of positions: 8, Pitch: 5.08 mm, Connection method: Screw connection, Color: green, Contact surface: Tin

---

#### Printed-circuit board connector - FRONT-MSTB 2,5/ 8-ST-5,08 - 1777345



Plug component, Nominal current: 12 A, Rated voltage (III/2): 320 V, Number of positions: 8, Pitch: 5.08 mm, Connection method: Screw connection, Color: green, Contact surface: Tin

---

#### Printed-circuit board connector - MSTBP 2,5/ 8-ST-5,08 - 1769078



Plug component, Nominal current: 12 A, Rated voltage (III/2): 320 V, Number of positions: 8, Pitch: 5.08 mm, Connection method: Screw connection, Color: green, Contact surface: Tin

---

#### Printed-circuit board connector - MSTB 2,5/ 8-STZ-5,08 - 1764235



Plug component, Nominal current: 12 A, Rated voltage (III/2): 320 V, Number of positions: 8, Pitch: 5.08 mm, Connection method: Screw connection, Color: green, Contact surface: Tin

---

#### Printed-circuit board connector - MSTB 2,5/ 8-ST-5,08 - 1757077



Plug component, Nominal current: 12 A, Rated voltage (III/2): 320 V, Number of positions: 8, Pitch: 5.08 mm, Connection method: Screw connection, Color: green, Contact surface: Tin

## Base strip - MSTBVA 2,5/ 8-G-5,08 THT - 1902877

### Accessories

Printed-circuit board connector - FKCVW 2,5/ 8-ST-5,08 - 1873715

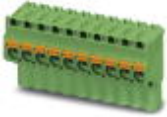

Plug component, Nominal current: 12 A, Rated voltage (III/2): 320 V, Number of positions: 8, Pitch: 5.08 mm, Connection method: Spring-cage connection, Color: green, Contact surface: Tin

Printed-circuit board connector - FKC 2,5/ 8-ST-5,08 - 1873113



Plug component, Nominal current: 12 A, Rated voltage (III/2): 320 V, Number of positions: 8, Pitch: 5.08 mm, Connection method: Spring-cage connection, Color: green, Contact surface: Tin

Base strip - A-ICV 2,5/ 8-G-5,08 - 1872758



Base strip, Nominal current: 12 A, Nominal voltage: 250 V, Mounting type: DIN rail mounting, Number of positions: 8, Pitch: 5.08 mm, Color: green

Printed-circuit board connector - TMSTBP 2,5/ 8-ST-5,08 - 1853078



Plug component, Nominal current: 12 A, Rated voltage (III/2): 320 V, Number of positions: 8, Pitch: 5.08 mm, Connection method: Screw connection, Color: green, Contact surface: Tin, The plug allows conductors to be looped through from module to module.

Printed-circuit board connector - MSTBC 2,5/ 8-ST-5,08 - 1808874



Plug component, Nominal current: 12 A, Rated voltage (III/2): 320 V, Number of positions: 8, Pitch: 5.08 mm, Connection method: Crimp connection, Color: green, Corresponding female crimp contacts with current [A] and conductor cross section range [mm<sup>2</sup>] data: 10A/MSTBC-MT 0,5-1,0 (3190564); 10A/MSTBC-MT 0,5-1,0 BA (3190645); 12A/MSTBC-MT 1,5-2,5 (3190551); 12A/MSTBC-MT 1,5-2,5 BA (3190658). BA = Bandkontakte

## Base strip - MSTBVA 2,5/ 8-G-5,08 THT - 1902877

### Accessories

Printed-circuit board connector - MVSTBW 2,5/ 8-ST-5,08 - 1792812



Plug component, Nominal current: 12 A, Rated voltage (III/2): 320 V, Number of positions: 8, Pitch: 5.08 mm, Connection method: Screw connection, Color: green, Contact surface: Tin

---

Printed-circuit board connector - QC 1/ 8-ST-5,08 - 1883310

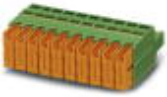

Plug component, Nominal current: 10 A, Rated voltage (III/2): 630 V, Number of positions: 8, Pitch: 5.08 mm, Connection method: Insulation displacement connection QUICKON, Color: green, Contact surface: Tin

---

Printed-circuit board connector - FKCVR 2,5/ 8-ST-5,08 - 1874015



Plug component, Nominal current: 12 A, Rated voltage (III/2): 320 V, Number of positions: 8, Pitch: 5.08 mm, Connection method: Spring-cage connection, Color: green, Contact surface: Tin

---

### Drawings

# Base strip - MSTBVA 2,5/ 8-G-5,08 THT - 1902877

Dimensioned drawing

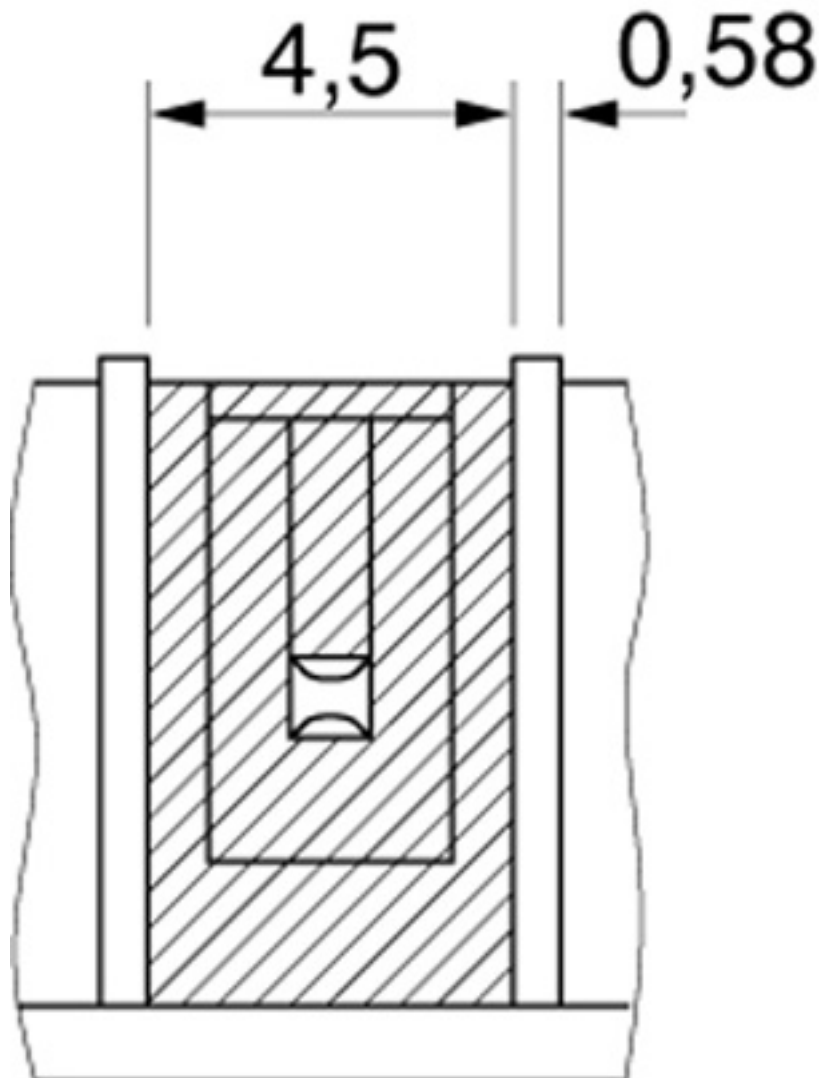

# Base strip - MSTBVA 2,5/ 8-G-5,08 THT - 1902877

Drilling diagram

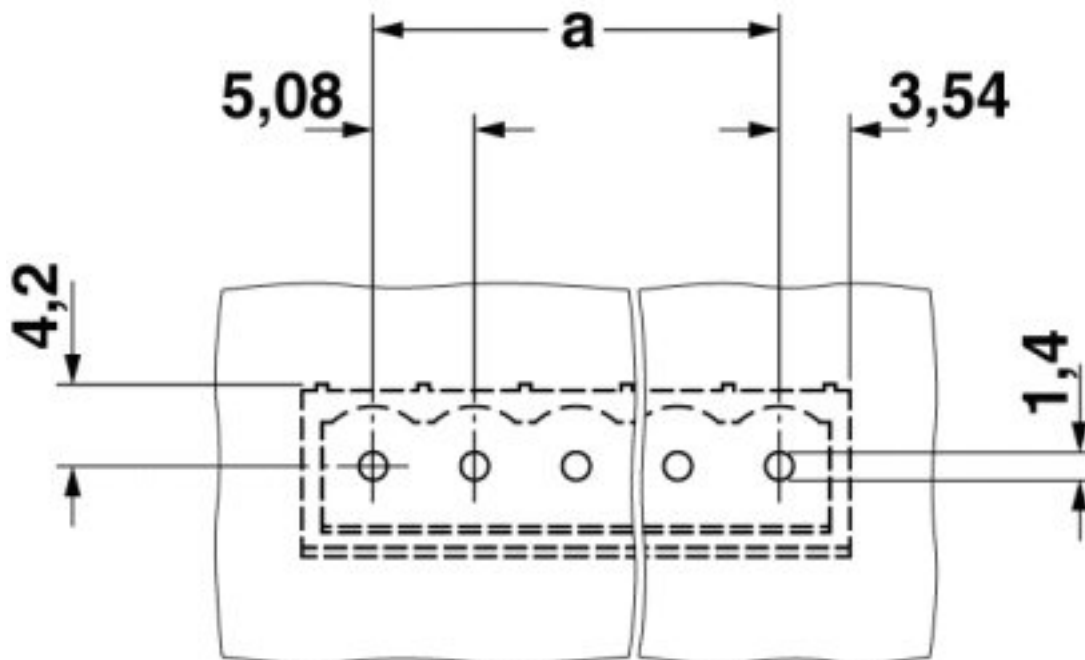

Dimensioned drawing

