

Base strip - MSTBA 2,5/ 7-G-5,08 THT - 1902796

Please be informed that the data shown in this PDF Document is generated from our Online Catalog. Please find the complete data in the user's documentation. Our General Terms of Use for Downloads are valid (<http://phoenixcontact.com/download>)



Header, Nominal current: 12 A, Rated voltage (III/2): 320 V, Number of positions: 7, Pitch: 5.08 mm, Color: black, Contact surface: Tin, Mounting: SMD/THT/THR, User information and design recommendations for through hole reflow technology can be found under "Downloads"

The illustration shows an 8-position version



Key commercial data

Packing unit	50 pc
Minimum order quantity	50 pc
GTIN	 4 017918 187705
Weight per Piece (excluding packing)	3.89 g
Custom tariff number	85366990
Country of origin	Germany
Note	Made to Order (non-returnable)

Technical data

Dimensions

Length	12 mm
Pitch	5.08 mm
Dimension a	30.48 mm
Pin dimensions	1 x 1 mm
Hole diameter	1.4 mm

General

Range of articles	MSTBA 2,5/..-G-THT
Insulating material group	IIIa
Rated surge voltage (III/3)	4 kV
Rated surge voltage (III/2)	4 kV
Rated surge voltage (II/2)	4 kV
Rated voltage (III/3)	250 V
Rated voltage (III/2)	320 V

Base strip - MSTBA 2,5/ 7-G-5,08 THT - 1902796

Technical data

General

Rated voltage (II/2)	400 V
Connection in acc. with standard	EN-VDE
Nominal current I _N	12 A
Maximum load current	12 A
Insulating material	PA
Inflammability class according to UL 94	V0
Color	black
Number of positions	7

Classifications

eCl@ss

eCl@ss 4.0	272607xx
eCl@ss 4.1	27260701
eCl@ss 5.0	27260701
eCl@ss 5.1	27260701
eCl@ss 6.0	27260704
eCl@ss 7.0	27440402
eCl@ss 8.0	27440402

ETIM

ETIM 3.0	EC001121
ETIM 4.0	EC002637
ETIM 5.0	EC002637

UNSPSC

UNSPSC 6.01	30211810
UNSPSC 7.0901	39121409
UNSPSC 11	39121409
UNSPSC 12.01	39121409
UNSPSC 13.2	39121409

Approvals

Approvals

Approvals

UL Recognized / VDE Gutachten mit Fertigungsüberwachung / cUL Recognized / IECCE CB Scheme / CCA / EAC / cULus Recognized

Ex Approvals

Base strip - MSTBA 2,5/ 7-G-5,08 THT - 1902796

Approvals

Approvals submitted

Approval details

UL Recognized 		
	B	D
Nominal current IN	15 A	10 A
Nominal voltage UN	300 V	300 V

VDE Gutachten mit Fertigungsüberwachung 	
Nominal current IN	12 A
Nominal voltage UN	250 V

cUL Recognized 		
	B	D
Nominal current IN	15 A	10 A
Nominal voltage UN	300 V	300 V

IECEE CB Scheme 	
Nominal current IN	12 A
Nominal voltage UN	250 V

CCA	
Nominal current IN	12 A
Nominal voltage UN	250 V

EAC	
-----	--

Base strip - MSTBA 2,5/ 7-G-5,08 THT - 1902796

Approvals

cULus Recognized 

Accessories

Accessories

Coding element

Coding star - CR-MSTB - 1734401



Coding section, inserted into the recess in the header or the inverted plug, red insulating material

Filler plug

Accessories - MSTB-BL - 1755477



Keying cap, for forming sections, plugs onto header pin, green insulating material

Labeled terminal marker

Marker card - SK 5,08/3,8:FORTL.ZAHLEN - 0804293



Marker card, Card, white, labeled, Horizontal: Consecutive numbers 1 - 10, 11 - 20, etc. up to 91 - (99)100, Mounting type: Adhesive, for terminal block width: 5.08 mm, Lettering field: 5.08 x 3.8 mm

Additional products

Printed-circuit board connector - FRONT-MSTB 2,5/ 7-ST-5,08 - 1777332



Plug component, Nominal current: 12 A, Rated voltage (III/2): 320 V, Number of positions: 7, Pitch: 5.08 mm, Connection method: Screw connection, Color: green, Contact surface: Tin

Base strip - MSTBA 2,5/ 7-G-5,08 THT - 1902796

Accessories

Printed-circuit board connector - MSTBP 2,5/ 7-ST-5,08 - 1769065



Plug component, Nominal current: 12 A, Rated voltage (III/2): 320 V, Number of positions: 7, Pitch: 5.08 mm, Connection method: Screw connection, Color: green, Contact surface: Tin

Printed-circuit board connector - FKCT 2,5/ 7-ST-5,08 - 1902165



Plug component, Nominal current: 12 A, Rated voltage (III/2): 320 V, Number of positions: 7, Pitch: 5.08 mm, Connection method: Spring-cage connection, Color: green, Contact surface: Tin

Printed-circuit board connector - QC 1/ 7-ST-5,08 - 1883307



Plug component, Nominal current: 10 A, Rated voltage (III/2): 630 V, Number of positions: 7, Pitch: 5.08 mm, Connection method: Insulation displacement connection QUICKON, Color: green, Contact surface: Tin

Printed-circuit board connector - FKCVR 2,5/ 7-ST-5,08 - 1874002



Plug component, Nominal current: 12 A, Rated voltage (III/2): 320 V, Number of positions: 7, Pitch: 5.08 mm, Connection method: Spring-cage connection, Color: green, Contact surface: Tin

Printed-circuit board connector - FKCVW 2,5/ 7-ST-5,08 - 1873702



Plug component, Nominal current: 12 A, Rated voltage (III/2): 320 V, Number of positions: 7, Pitch: 5.08 mm, Connection method: Spring-cage connection, Color: green, Contact surface: Tin

Base strip - MSTBA 2,5/ 7-G-5,08 THT - 1902796

Accessories

Printed-circuit board connector - FKC 2,5/ 7-ST-5,08 - 1873100

Plug component, Nominal current: 12 A, Rated voltage (III/2): 320 V, Number of positions: 7, Pitch: 5.08 mm, Connection method: Spring-cage connection, Color: green, Contact surface: Tin



Base strip - A-ICV 2,5/ 7-G-5,08 - 1872745



Base strip, Nominal current: 12 A, Nominal voltage: 250 V, Mounting type: DIN rail mounting, Number of positions: 7, Pitch: 5.08 mm, Color: green

Printed-circuit board connector - SMSTB 2,5/ 7-ST-5,08 - 1826335

Plug component, Nominal current: 12 A, Rated voltage (III/2): 320 V, Number of positions: 7, Pitch: 5.08 mm, Connection method: Screw connection, Color: green, Contact surface: Tin



Printed-circuit board connector - MSTBC 2,5/ 7-STZ-5,08 - 1809556

Plug component, Nominal current: 12 A, Rated voltage (III/2): 320 V, Number of positions: 7, Pitch: 5.08 mm, Connection method: Crimp connection, Color: green, Corresponding female crimp contacts with current [A] and conductor cross section range [mm²] data: 10A/MSTBC-MT 0,5-1,0 (3190564); 10A/MSTBC-MT 0,5-1,0 BA (3190645); 12A/MSTBC-MT 1,5-2,5 (3190551); 12A/MSTBC-MT 1,5-2,5 BA (3190658). BA = Bandkontakte



Printed-circuit board connector - MSTBC 2,5/ 7-ST-5,08 - 1808861

Plug component, Nominal current: 12 A, Rated voltage (III/2): 320 V, Number of positions: 7, Pitch: 5.08 mm, Connection method: Crimp connection, Color: green, Corresponding female crimp contacts with current [A] and conductor cross section range [mm²] data: 10A/MSTBC-MT 0,5-1,0 (3190564); 10A/MSTBC-MT 0,5-1,0 BA (3190645); 12A/MSTBC-MT 1,5-2,5 (3190551); 12A/MSTBC-MT 1,5-2,5 BA (3190658). BA = Bandkontakte



Base strip - MSTBA 2,5/ 7-G-5,08 THT - 1902796

Accessories

Printed-circuit board connector - MVSTBW 2,5/ 7-ST-5,08 - 1792809



Plug component, Nominal current: 12 A, Rated voltage (III/2): 320 V, Number of positions: 7, Pitch: 5.08 mm, Connection method: Screw connection, Color: green, Contact surface: Tin

Printed-circuit board connector - MVSTBR 2,5/ 7-ST-5,08 - 1792294



Plug component, Nominal current: 12 A, Rated voltage (III/2): 320 V, Number of positions: 7, Pitch: 5.08 mm, Connection method: Screw connection, Color: green, Contact surface: Tin

Base strip - IC 2,5/ 7-G-5,08 - 1786459



Header, Nominal current: 12 A, Rated voltage (III/2): 320 V, Number of positions: 7, Pitch: 5.08 mm, Color: green, Contact surface: Tin, Mounting: Soldering

Base strip - ICV 2,5/ 7-G-5,08 - 1785997



Header, Nominal current: 12 A, Rated voltage (III/2): 320 V, Number of positions: 7, Pitch: 5.08 mm, Color: green, Contact surface: Tin, Mounting: Soldering

Printed-circuit board connector - MSTBT 2,5/ 7-ST-5,08 - 1781030



Plug component, Nominal current: 12 A, Rated voltage (III/2): 320 V, Number of positions: 7, Pitch: 5.08 mm, Connection method: Screw connection, Color: green, Contact surface: Tin

Base strip - MSTBA 2,5/ 7-G-5,08 THT - 1902796

Accessories

Printed-circuit board connector - MSTB 2,5/ 7-STZ-5,08 - 1776113



Plug component, Nominal current: 12 A, Rated voltage (III/2): 320 V, Number of positions: 7, Pitch: 5.08 mm, Connection method: Screw connection, Color: green, Contact surface: Tin

Printed-circuit board connector - MSTB 2,5/ 7-ST-5,08 - 1757064



Plug component, Nominal current: 12 A, Rated voltage (III/2): 320 V, Number of positions: 7, Pitch: 5.08 mm, Connection method: Screw connection, Color: green, Contact surface: Tin

Printed-circuit board connector - TMSTBP 2,5/ 7-ST-5,08 - 1853065



Plug component, Nominal current: 12 A, Rated voltage (III/2): 320 V, Number of positions: 7, Pitch: 5.08 mm, Connection method: Screw connection, Color: green, Contact surface: Tin, The plug allows conductors to be looped through from module to module.

Drawings

Base strip - MSTBA 2,5/ 7-G-5,08 THT - 1902796

Diagram

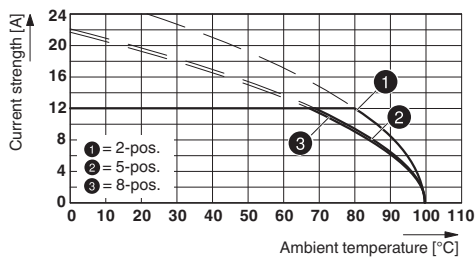

Dimensioned drawing

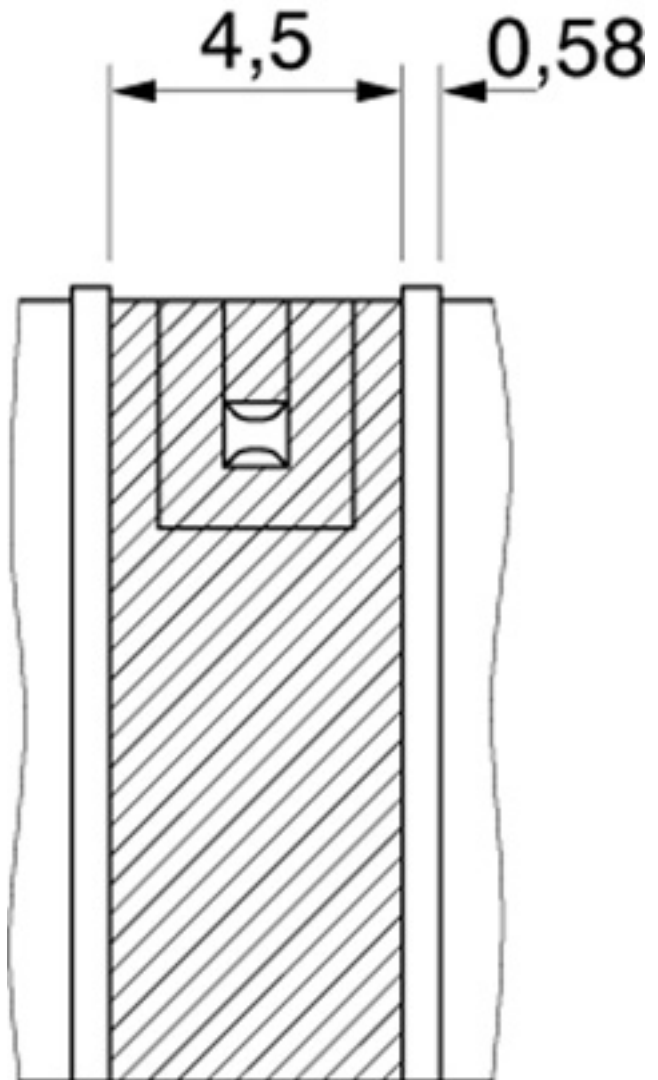

Type: FKC 2,5/...-ST-5,08 with MSTBA 2,5/...-G-5,08 THT

Base strip - MSTBA 2,5/ 7-G-5,08 THT - 1902796

Drilling diagram

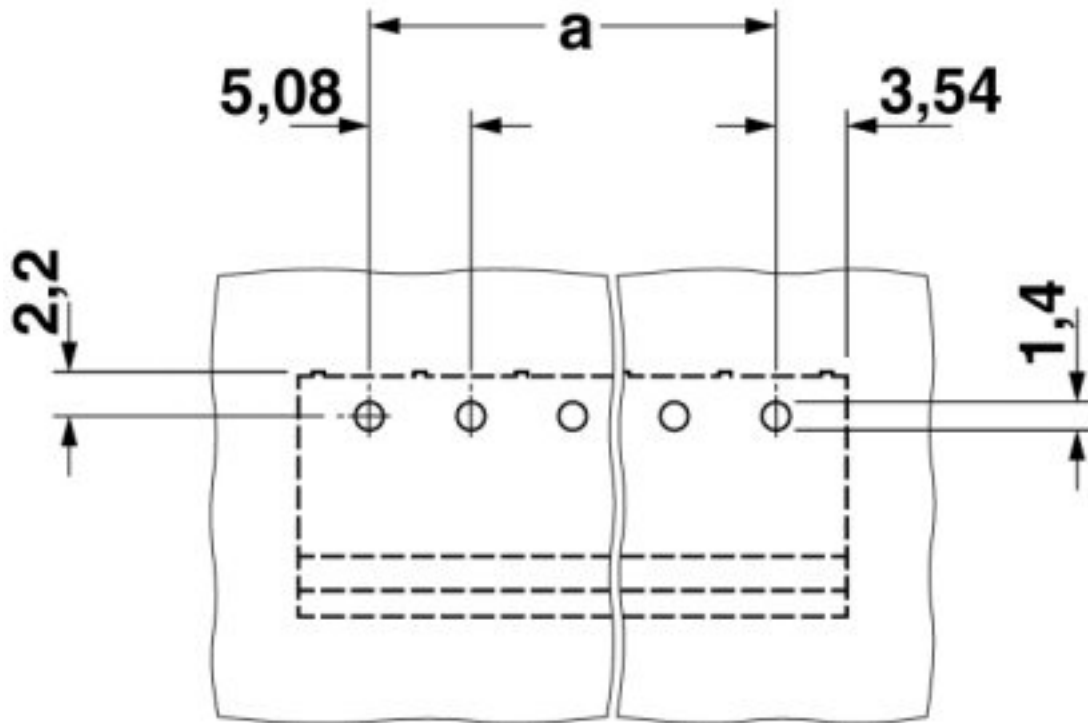

Dimensioned drawing

