

# Printed-circuit board connector - DMC 1,5/18-G1F-3,5-LR P20THR - 1787179

Please be informed that the data shown in this PDF Document is generated from our Online Catalog. Please find the complete data in the user's documentation. Our General Terms of Use for Downloads are valid (<http://phoenixcontact.com/download>)

Header, nominal current: 8 A, rated voltage (III/2): 160 V, number of positions: 18, pitch: 3.5 mm, Color: black, Contact surface: Tin, mounting: THR soldering



The figure shows a 10-pos. version with 20 contacts

## Why buy this product

- ✓ Designed for integration into the SMT soldering process
- ✓ Screwable flange for superior mechanical stability
- ✓ Automatic locking and intuitive release through Lock and Release operating lever in contrasting color
- ✓ Conductor connection on several levels enables higher contact density
- ✓ Small component size for applications where space is at a premium

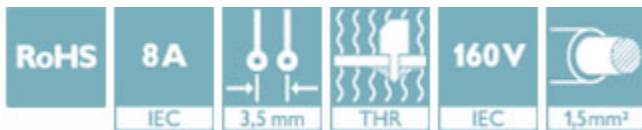

## Key Commercial Data

Packing unit	1 STK
GTIN	 4 046356 596787
GTIN	4046356596787
Weight per Piece (excluding packing)	8.600 g
Custom tariff number	85366930
Country of origin	Germany

## Technical data

### Dimensions

Length	11.6 mm
Pitch	3.5 mm

# Printed-circuit board connector - DMC 1,5/18-G1F-3,5-LR P20THR - 1787179

## Technical data

### Dimensions

Dimension a	59.50 mm
Width	70.00 mm
Constructional height	10.8 mm
Height	12.8 mm
Length of the solder pin	2 mm
Pin dimensions	0,8 x 0,8
Pin spacing	2.50 mm
Hole diameter	1.4 mm

### General

Range of articles	DMC 1,5/...-G1F-THR
Insulating material group	IIIa
Rated surge voltage (III/3)	2.5 kV
Rated surge voltage (III/2)	2.5 kV
Rated surge voltage (II/2)	2.5 kV
Rated voltage (III/3)	160 V
Rated voltage (III/2)	160 V
Rated voltage (II/2)	250 V
Connection in acc. with standard	EN-VDE
Nominal current I <sub>N</sub>	8 A
Maximum load current	8 A
Insulating material	LCP
Flammability rating according to UL 94	V0
Color	black
Number of positions	18

### Standards and Regulations

Connection in acc. with standard	EN-VDE
	CUL
Flammability rating according to UL 94	V0

### Environmental Product Compliance

China RoHS	Environmentally friendly use period: unlimited = EFUP-e
	No hazardous substances above threshold values

## Drawings

# Printed-circuit board connector - DMC 1,5/18-G1F-3,5-LR P20THR - 1787179

Schematic diagram

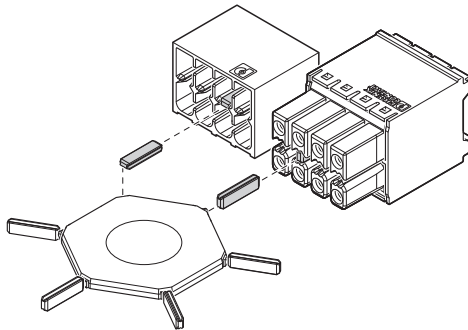

Drilling diagram

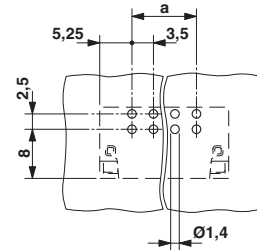

Use of the CP-DMC... coding profile

Diagram

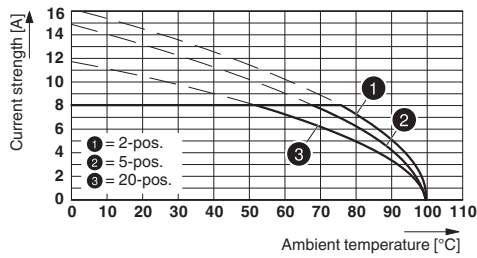

Dimensional drawing

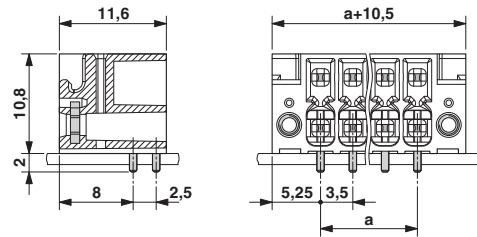

Type: DFMC 1,5/...-ST-3,5-LR with DMC 1,5/...-G1F-3,5-LR P20 THR

Schematic diagram

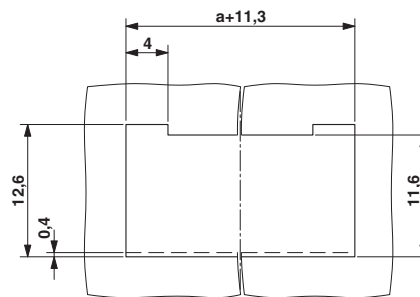

Panel cutout

## Classifications

eCl@ss

eCl@ss 4.0	272607xx
------------	----------

# Printed-circuit board connector - DMC 1,5/18-G1F-3,5-LR P20THR - 1787179

## Classifications

### eCl@ss

eCl@ss 4.1	27260701
eCl@ss 5.0	27260701
eCl@ss 5.1	27260701
eCl@ss 6.0	27260704
eCl@ss 7.0	27440402
eCl@ss 8.0	27440402
eCl@ss 9.0	27440402

### ETIM

ETIM 4.0	EC002637
ETIM 5.0	EC002637
ETIM 6.0	EC002637

### UNSPSC

UNSPSC 6.01	30211810
UNSPSC 7.0901	39121409
UNSPSC 11	39121409
UNSPSC 12.01	39121409
UNSPSC 13.2	39121409

## Approvals

### Approvals

#### Approvals

VDE Gutachten mit Fertigungsüberwachung / IECCEB CB Scheme / cULus Recognized / EAC

#### Ex Approvals

### Approval details

VDE Gutachten mit Fertigungsüberwachung		<a href="http://www.vde.com/en/Institute/OnlineService/VDE-approved-products/Pages/Online-Search.aspx">http://www.vde.com/en/Institute/OnlineService/ VDE-approved-products/Pages/Online-Search.aspx</a>	40038423
Nominal current I <sub>N</sub>	8 A		

# Printed-circuit board connector - DMC 1,5/18-G1F-3,5-LR P20THR - 1787179

## Approvals

Nominal voltage UN	160 V
--------------------	-------

IECEE CB Scheme		<a href="http://www.iecee.org/">http://www.iecee.org/</a>	DE1-56070_B1_B2
Nominal current IN	8 A		
Nominal voltage UN	160 V		

cULus Recognized		<a href="http://database.ul.com/cgi-bin/XYV/template/LISEXT/1FRAME/index.htm">http://database.ul.com/cgi-bin/XYV/template/LISEXT/1FRAME/index.htm</a>	E60425-20110128
	B	C	
Nominal current IN	8 A	8 A	
Nominal voltage UN	150 V	50 V	

EAC		B.01742
-----	--	---------

## Accessories

Accessories

Coding element

Coding profile - CP-DMC 1,5 NAT - 1790647

Coding profile, for insertion between the coding ribs of the connector and the header following the reflow soldering process, insulating material, color: natural



## Additional products

## Printed-circuit board connector - DMC 1,5/18-G1F-3,5-LR P20THR - 1787179

### Accessories

Printed-circuit board connector - DFMC 1,5/18-STF-3,5 - 1790454

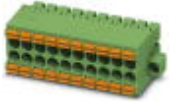

Plug, nominal current: 8 A, rated voltage (III/2): 160 V, number of positions: 18 with 36 contacts, pitch: 3.5 mm, connection method: spring-cage connection, color: green, contact surface: tin

---

Printed-circuit board connector - DFMC 1,5/18-ST-3,5-LR - 1790645



Plug, nominal current: 8 A, rated voltage (III/2): 160 V, number of positions: 18 with 36 contacts, pitch: 3.5 mm, connection method: spring-cage connection, color: green, contact surface: tin