

Printed-circuit board connector - TFMC 1,5/10-STF-3,5 - 1772786

Please be informed that the data shown in this PDF Document is generated from our Online Catalog. Please find the complete data in the user's documentation. Our General Terms of Use for Downloads are valid (<http://phoenixcontact.com/download>)

Plug component, Nominal current: 8 A, Rated voltage (III/2): 160 V, Number of positions: 10, Pitch: 3.5 mm, Connection method: Spring-cage connection, Color: green, Contact surface: Tin

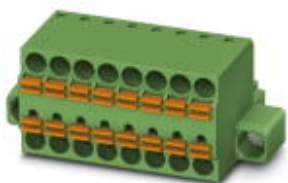

Why buy this product

- ✓ Very compact, front TWIN connection for 1.5 mm²
- ✓ Fast conductor connection thanks to Push-in spring-cage connection
- ✓ Signal distribution of up to 8 A directly on the device
- ✓ Two connections per position
- ✓ Touch connection for voltage testing using a 1 mm Ø test pin



Key commercial data

Packing unit	50 pc
Minimum order quantity	50 pc
GTIN	 4 046356 464123
Weight per Piece (excluding packing)	12.14 g
Custom tariff number	85366990
Country of origin	Poland
Note	Made to Order (non-returnable)

Technical data

Dimensions

Pitch	3.5 mm
Dimension a	31.5 mm

General

Range of articles	TFMC 1,5/...-STF
Insulating material group	I
Rated surge voltage (III/3)	2.5 kV
Rated surge voltage (III/2)	2.5 kV
Rated surge voltage (II/2)	2.5 kV

Printed-circuit board connector - TFMC 1,5/10-STF-3,5 - 1772786

Technical data

General

Rated voltage (III/3)	160 V
Rated voltage (III/2)	160 V
Rated voltage (II/2)	320 V
Connection in acc. with standard	EN-VDE
Nominal current I_N	8 A
Nominal cross section	1.5 mm ²
Maximum load current	8 A
Insulating material	PA
Inflammability class according to UL 94	V0
Internal cylindrical gage	A1
Stripping length	10 mm
Number of positions	10

Connection data

Conductor cross section solid min.	0.2 mm ²
Conductor cross section solid max.	1.5 mm ²
Conductor cross section stranded min.	0.2 mm ²
Conductor cross section stranded max.	1.5 mm ²
Conductor cross section stranded, with ferrule without plastic sleeve min.	0.25 mm ²
Conductor cross section stranded, with ferrule without plastic sleeve max.	1.5 mm ²
Conductor cross section stranded, with ferrule with plastic sleeve min.	0.25 mm ²
Conductor cross section stranded, with ferrule with plastic sleeve max.	0.75 mm ²
Conductor cross section AWG/kcmil min.	24
Conductor cross section AWG/kcmil max.	16
Minimum AWG according to UL/CUL	24
Maximum AWG according to UL/CUL	16

Classifications

eCl@ss

eCl@ss 4.0	272607xx
eCl@ss 4.1	27260701
eCl@ss 5.0	27260701
eCl@ss 5.1	27260701
eCl@ss 6.0	27260704
eCl@ss 7.0	27440402
eCl@ss 8.0	27440309

ETIM

ETIM 3.0	EC001121
----------	----------

Printed-circuit board connector - TFMC 1,5/10-STF-3,5 - 1772786

Classifications

ETIM

ETIM 4.0	EC002638
ETIM 5.0	EC002638

UNSPSC

UNSPSC 6.01	30211810
UNSPSC 7.0901	39121409
UNSPSC 11	39121409
UNSPSC 12.01	39121409
UNSPSC 13.2	39121409

Approvals

Approvals

Approvals

UL Recognized / cUL Recognized / EAC / VDE Gutachten mit Fertigungsüberwachung / cULus Recognized

Ex Approvals

Approvals submitted

Approval details

UL Recognized 			
		B	C
mm ² /AWG/kcmil	24-16	24-16	
Nominal current I _N	8 A	8 A	
Nominal voltage U _N	300 V	50 V	

cUL Recognized 			
		B	C
mm ² /AWG/kcmil	24-16	24-16	
Nominal current I _N	8 A	8 A	
Nominal voltage U _N	300 V	50 V	

Printed-circuit board connector - TFMC 1,5/10-STF-3,5 - 1772786

Approvals

EAC

VDE Gutachten mit Fertigungsüberwachung 

mm ² /AWG/kcmil	0.2-1.5
Nominal current I _N	8 A
Nominal voltage U _N	160 V

cULus Recognized 

Accessories

Accessories

Labeled terminal marker

Marker card - SK 3,5/2,8:FORTL.ZAHLEN - 0804073



Marker card, Card, white, labeled, Horizontal: Consecutive numbers 1 - 10, 11 - 20, etc. up to 91 - 99, Mounting type: Adhesive, for terminal block width: 3.5 mm, Lettering field: 3.5 x 2.8 mm

Marker pen

Marker pen - B-STIFT - 1051993



Marker pen, for manual labeling of unprinted Zack strips, smear-proof and waterproof, line thickness 0.5 mm

Terminal marking

Marker card - SK U/2,8 WH:UNBEDRUCKT - 0803883



Marker card, Sheet, white, unlabeled, can be labeled with: Plotter, Office printing systems, Mounting type: Adhesive, Lettering field: 186 x 2.8 mm

Printed-circuit board connector - TFMC 1,5/10-STF-3,5 - 1772786

Accessories

Drawings

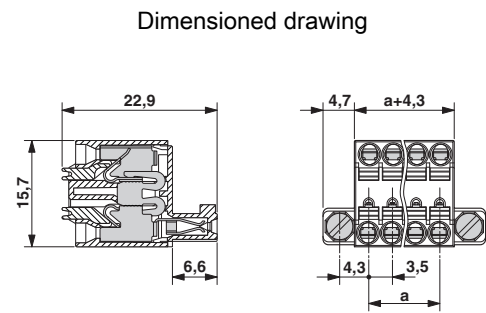
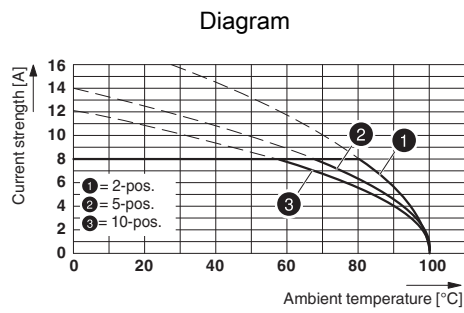

Type: TFMC 1,5/...-STF-3,5 with MC 1,5/...-GF-3,5