

OMNIMATE Signal - series BL/SL 5.08
BLL 5.08/04/90 3.2 SN OR BX

Weidmüller Interface GmbH & Co. KG
 Klingenbergstraße 16
 D-32758 Detmold
 Germany
 Fon: +49 5231 14-0
 Fax: +49 5231 14-292083
 www.weidmueller.com

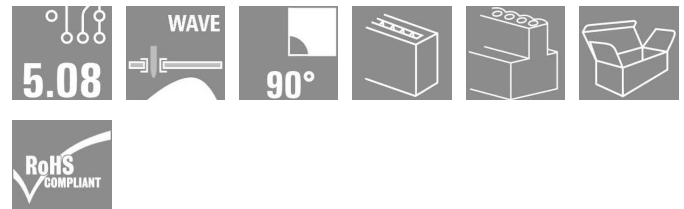

Female header for PCB mounting. The solder pin length is optimised for wave flow soldering.

- 400 V (IEC) / 300 V (UL)
- 23 A (IEC) / 15 A (UL)

General ordering data

Type	BLL 5.08/04/90 3.2 SN OR BX
Order No.	1622960000
Version	PCB plug-in connector, female header, closed side, Solder connection, 5.08 mm, No. of poles: 4, 90°, Solder pin length (l): 3.2 mm, tinned, Orange, Box
GTIN (EAN)	4008190194024
Qty.	90 pc(s).
Product data	IEC: 400 V / 23 A UL: 300 V / 15 A
Packaging	Box

OMNIMATE Signal - series BL/SL 5.08
BLL 5.08/04/90 3.2 SN OR BX

Weidmüller Interface GmbH & Co. KG
 Klingenbergstraße 16
 D-32758 Detmold
 Germany
 Fon: +49 5231 14-0
 Fax: +49 5231 14-292083
 www.weidmueller.com

Technical data

Dimensions and weights

Net weight 4.19 g

System parameters

Product family	OMNIMATE Signal - series BL/SL 5.08	Mounting onto the PCB	Solder connection
Outgoing elbow	90°	Pitch in mm (P)	5.08 mm
Pitch in inches (P)	0.2 inch	No. of poles	4
Solder pin length (l)	3.2 mm	Pin dimensions	0.4 x 1.00 mm
Can be coded	Yes	Number of solder pins per pole	2
Solder eyelet hole diameter (D)	1.3 mm	Solder eyelet hole diameter tolerance (D)	+ 0,1 mm
L1 in mm	15.24 mm	L1 in inches	0.6 inch
Insulation resistance	10 ³ Ω	Touch-safe protection acc. to DIN VDE 57 106	Safe from finger touch

Material data

Insulating material	PBT GF	Colour	Orange
Insulating material group	IIIa	UL 94 flammability rating	V-0
CTI	≥ 200	Contact material	Cu-Leg
Contact surface	tinned	Operating temperature, min.	-50 °C
Operating temperature, max.	100 °C	Temperature range, installation, min.	-25 °C
Temperature range, installation, max.	100 °C	Max. relative humidity during storage	80 %

DIN IEC rating data

Rated current, min. no. of poles (Tu=20°C)	23 A	Rated current, max. no. of poles (Tu=20°C)	16 A
Rated current, number of poles (Tu=40°C), min	20 A	Rated current, number of poles (Tu=40°C), max.	14 A
Rated voltage for surge voltage class / pollution degree III/3	250 V	Rated impulse voltage for surge voltage class/ contamination degree III/3	4 kV
Rated voltage for surge voltage class / pollution degree III/2	320 V	Rated impulse voltage for surge voltage class/ pollution degree III/2	4 kV
Rated voltage for surge voltage class / pollution degree II/2	400 V	Rated impulse voltage for surge voltage class/ pollution degree II/2	4 kV
Short-time withstand current resistance	3 x 1s with 120 A		

CSA rating data

Institute (CSA)		Rated voltage (Use group B)	300 V
Rated current (use group B)	15 A	Rated voltage (use group D)	300 V
Rated current (use group D)	10 A		

UL 1059 rating data

Institute (UR)		Rated voltage (use group B)	300 V
Rated current (use group B)	15 A	Rated voltage (use group D)	300 V
Rated current (use group D)	10 A		

Data sheet

**OMNIMATE Signal - series BL/SL 5.08
BLL 5.08/04/90 3.2 SN OR BX**

Weidmüller Interface GmbH & Co. KG
Klingenbergstraße 16
D-32758 Detmold
Germany
Fon: +49 5231 14-0
Fax: +49 5231 14-292083
www.weidmueller.com

Technical data

Classifications

ETIM 3.0	EC001284	UNSPSC	30-21-18-10
eClass 5.1	27-26-07-04	eClass 6.2	27-26-07-04
eClass 7.1	27-44-04-02		

Notes

- Notes
- Additional colours on request
 - Gold-plated contact surfaces on request
 - Rated current related to rated cross-section & min. No. of poles.
 - P on drawing = pitch
 - Rated data refer only to the component itself. Clearance and creepage distances to other components are to be designed in accordance with the relevant application standards.

Approvals

Approvals



ROHS Conform

Downloads

- CAD Library (P-CAD Format - ASCII) [BLL.zip](#)
- CAD Library (P-CAD Format - Standard) [BLL.zip](#)
- [3-D model](#)

Data sheet**OMNIMATE Signal - series BL/SL 5.08
BLL 5.08/04/90 3.2 SN OR BX**

Weidmüller Interface GmbH & Co. KG
Klingenbergstraße 16
D-32758 Detmold
Germany
Fon: +49 5231 14-0
Fax: +49 5231 14-292083
www.weidmueller.com

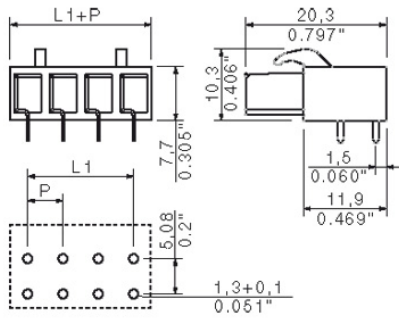
Drawings

**OMNIMATE Signal - series BL/SL 5.08
BLL 5.08/04/90 3.2 SN OR BX**

Weidmüller Interface GmbH & Co. KG
Klingenbergstraße 16
D-32758 Detmold
Germany
Fon: +49 5231 14-0
Fax: +49 5231 14-292083
www.weidmueller.com

Mating connector (fully pluggable)
SL 5.08/135

Male connectors with 135° outlet direction. The solder pin length is optimised for wave flow soldering. The pin headers provide space for labelling and can be coded.

- 400 V (IEC) / 300 V (UL)
- 17 A (IEC) / 15 A (UL)

General ordering data

Type	Order No.	Version	GTIN (EAN)	Qty.	Product data	Packaging
SL 5.08/04/135 3.2SN OR BX	1603080000	PCB plug-in connector, male header, open side, Solder connection, 5.08 mm, No. of poles: 4, 135°, Solder pin length (l): 3.2 mm, tinned, Orange, Box	4008190164997	100 pc(s).	IEC: 400 V / 17 A UL: 300 V / 15 A	Box

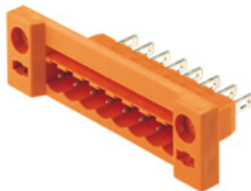
SLDF 5.08

Male connector for through-panel mounting with optional locking function. Internal connection as flat-blade or solder connection. These male connectors provide space for labelling and can be coded.

- 400 V (IEC) / 300 V (UL)
- 15 A (IEC) / 10 A (UL)

General ordering data

Type	Order No.	Version	GTIN (EAN)	Qty.	Product data	Packaging
SLDF 5.08 L/F 4 SN BK BX	1635760000	PCB plug-in connector, male header, 5.08 mm, No. of poles: 4, 180°, Flat-blade connection, Solder connection, Box	4008190264192	100 pc(s).	IEC: 400 V / 15 A UL: 300 V / 10 A	Box
SLDF 5.08 L/F 4 SN OR BX	1599150000	PCB plug-in connector, male header, 5.08 mm, No. of poles: 4, 180°, Flat-blade connection, Solder connection, Box	4008190133627	100 pc(s).	IEC: 400 V / 15 A UL: 300 V / 10 A	Box

**OMNIMATE Signal - series BL/SL 5.08
BLL 5.08/04/90 3.2 SN OR BX**

Weidmüller Interface GmbH & Co. KG
Klingenbergstraße 16
D-32758 Detmold
Germany
Fon: +49 5231 14-0
Fax: +49 5231 14-292083
www.weidmueller.com

Mating connector (fully pluggable)
SLS 5.08/180 SN

Male plugs with clamping-yoke screw wire-connect system. The male plugs provide space for labelling and can be coded.

- 0.2 - 2.5 mm² (IEC) / 26 - 12 AWG (UL)
- 400 V (IEC) / 300 V (UL)
- 21.5 A (IEC) / 15 A (UL)

General ordering data

Type	Order No.	Version	GTIN (EAN)	Qty.	Product data	Packaging
SLS 5.08/04/180 SN OR BX	1627110000	PCB plug-in connector, male plug, 5.08 mm, No. of poles: 4, 180°, Clamping yoke connection, Clamping range, rated connection, max.: 3.31 mm ² , Box	4008190199623	100 pc(s).	IEC: 400 V / 21.5 A / 0.2 - 2.5 mm ² UL: 300 V / 14 A / AWG 26 - AWG 12	Box

SL-SMT 5.08/90G Box

High-temperature-resistant male header, packed in box or tape. In tape with 1.5 mm solder pin optimised for automatic assembly. 3.2 mm solder pin suitable for reflow and wave soldering. These male connectors provide space for labelling and can be coded.

- 400 V (IEC) / 300 V (UL)
- 19 A (IEC) / 15 A (UL)

General ordering data

Type	Order No.	Version	GTIN (EAN)	Qty.	Product data	Packaging
SL-SMT 5.08/04/90G 1.5SN BK BX	1775022001	PCB plug-in connector, male header, closed side, Reflow solder connection, 5.08 mm, No. of poles: 4, 90°, Solder pin length (l): 1.5 mm, tinned, Black, Box	4032248156085	100 pc(s).	IEC: 400 V / 19 A UL: 300 V / 15 A	Box
SL-SMT 5.08/04/90G 3.2SN BK BX	1780200000	PCB plug-in connector, male header, closed side, Reflow solder connection, 5.08 mm, No. of poles: 4, 90°, Solder pin length (l): 3.2 mm, tinned, Black, Box	4032248165520	100 pc(s).	IEC: 400 V / 19 A UL: 300 V / 15 A	Box

**OMNIMATE Signal - series BL/SL 5.08
BLL 5.08/04/90 3.2 SN OR BX**

Weidmüller Interface GmbH & Co. KG
Klingenbergstraße 16
D-32758 Detmold
Germany
Fon: +49 5231 14-0
Fax: +49 5231 14-292083
www.weidmueller.com

Mating connector (fully pluggable)
SL-SMT 5.08/180G Box

High-temperature-resistant male header, packed in box or tape. In tape with 1.5 mm solder pin optimised for automatic assembly. 3.2 mm solder pin suitable for reflow and wave soldering. These male connectors provide space for labelling and can be coded.

- 400 V (IEC) / 300 V (UL)
- 19 A (IEC) / 15 A (UL)

General ordering data

Type	Order No.	Version	GTIN (EAN)	Qty.	Product data	Packaging
SL-SMT 5.08/04/180G 1.5SN BK BX	1775942001	PCB plug-in connector, male header, closed side, Reflow solder connection, 5.08 mm, No. of poles: 4, 180°, Solder pin length (l): 1.5 mm, tinned, Black, Box	4032248158935	100 pc(s).	IEC: 400 V / 19 A UL: 300 V / 15 A	Box
SL-SMT 5.08/04/180G 3.2SN BK BX	1838230000	PCB plug-in connector, male header, closed side, Reflow solder connection, 5.08 mm, No. of poles: 4, 180°, Solder pin length (l): 3.2 mm, tinned, Black, Box	4032248348299	100 pc(s).	IEC: 400 V / 19 A UL: 300 V / 15 A	Box

SL 5.00/90

Male connectors with 90° outlet direction. The solder pin length is optimised for wave flow soldering. The pin headers provide space for labelling and can be coded.

- 400 V (IEC) / 300 V (UL)
- 18 A (IEC) / 15 A (UL)

General ordering data

Type	Order No.	Version	GTIN (EAN)	Qty.	Product data	Packaging
SL 5.00/04/90 4.5SN BK BX	1626010000	PCB plug-in connector, male header, open side, Solder connection, 5.00 mm, No. of poles: 4, 90°, Solder pin length (l): 4.5 mm, tinned, Black, Box	4008190197315	100 pc(s).	IEC: 400 V / 18 A UL: 300 V / 15 A	Box
SL 5.00/04/90 3.2SN OR BX	1571150000	PCB plug-in connector, male header, open side, Solder connection, 5.00 mm, No. of poles: 4, 90°, Solder pin	4008190107314	100 pc(s).	IEC: 400 V / 18 A UL: 300 V / 15 A	Box

OMNIMATE Signal - series BL/SL 5.08 BLL 5.08/04/90 3.2 SN OR BX

Weidmüller Interface GmbH & Co. KG
 Klingenbergstraße 16
 D-32758 Detmold
 Germany
 Fon: +49 5231 14-0
 Fax: +49 5231 14-292083
 www.weidmueller.com

Mating connector (fully pluggable)

length (l): 3.2 mm, tinned,
 Orange, Box

SL 5.08/90



Male connectors with 90° outlet direction. The solder pin length is optimised for wave flow soldering. The pin headers provide space for labelling and can be coded.

- 400 V (IEC) / 300 V (UL)
- 18 A (IEC) / 15 A (UL)

General ordering data

Delivery status	Available until	Type	Order No.	Version	GTIN (EAN)	Qty.
This article will no longer be available in the future.	2017-12-31T00:00:00+01:00	SL 5.08/04/90 3.2SN OR BX	1508260000	PCB plug-in connector, male header, open side, Solder connection, 5.08 mm, No. of poles: 4, 90°, Solder pin length (l): 3.2 mm, tinned, Orange, Box	4008190021207	100 pc(s)

SLZF 5.08/180



Male plugs with tension-clamp wire connection. The male plugs provide space for labelling and can be coded.

- 0.2 - 2.5 mm² (IEC) / 26 - 14 AWG (UL)
- 400 V (IEC) / 300 V (UL)
- 23 A (IEC) / 15 A (UL)

General ordering data

Delivery status	Available until	Type	Order No.	Version	GTIN (EAN)	Qty.
This article will no longer be available in the future.	2017-12-31T00:00:00+01:00	SLZF 5.08/04/180 SN BK BX	1709620000	PCB plug-in connector, male plug, 5.08 mm, No. of poles: 4, 180°, Tension clamp connection, Clamping range, rated connection, max.: 3.31 mm ² , Box	4008190318925	100 pc(s)

OMNIMATE Signal - series BL/SL 5.08 BLL 5.08/04/90 3.2 SN OR BX

Weidmüller Interface GmbH & Co. KG
 Klingenbergstraße 16
 D-32758 Detmold
 Germany
 Fon: +49 5231 14-0
 Fax: +49 5231 14-292083
 www.weidmueller.com

Mating connector (fully pluggable)

This article will no longer be available in the future.

SLZF 5.08/04/180 SN OR [1709390000](#)
 BX

PCB plug-in connector, male
 plug, 5.08 mm,
 No. of poles: 4,
 180°, Tension
 clamp connection,
 Clamping range,
 rated connection,
 max.: 3.31 mm²,
 Box

SL-SMT 5.08/90 Box



High-temperature-resistant, 90° angled, open male header
 Packed in box or tape. In tape with 1.5 mm solder pin
 optimised for automatic assembly. 3.2 mm solder pin
 suitable for reflow and wave soldering. These male
 connectors provide space for labelling and can be coded.

- 400 V (IEC) / 300 V (UL)
- 19 A (IEC) / 15 A (UL)

General ordering data

Type	Order No.	Version	GTIN (EAN)	Qty.	Product data	Packaging
SL-SMT 5.08/04/90 1.5SN BK BX	1774782001	PCB plug-in connector, male header, open side, Reflow solder connection, 5.08 mm, No. of poles: 4, 90°, Solder pin length (l): 1.5 mm, tinned, Black, Box	4032248155811	100 pc(s).	IEC: 400 V / 19 A UL: 300 V / 15 A	Box
SL-SMT 5.08/04/90 3.2SN BK BX	1779970000	PCB plug-in connector, male header, open side, Reflow solder connection, 5.08 mm, No. of poles: 4, 90°, Solder pin length (l): 3.2 mm, tinned, Black, Box	4032248165292	100 pc(s).	IEC: 400 V / 19 A UL: 300 V / 15 A	Box

**OMNIMATE Signal - series BL/SL 5.08
BLL 5.08/04/90 3.2 SN OR BX**

Weidmüller Interface GmbH & Co. KG
Klingenbergstraße 16
D-32758 Detmold
Germany
Fon: +49 5231 14-0
Fax: +49 5231 14-292083
www.weidmueller.com

Mating connector (fully pluggable)
SL-SMT 5.08/90 Tape

High-temperature-resistant, 90° angled, open male header
Packed in box or tape. In tape with 1.5 mm solder pin
optimised for automatic assembly. 3.2 mm solder pin
suitable for reflow and wave soldering. These male
connectors provide space for labelling and can be coded.

- 400 V (IEC) / 300 V (UL)
- 19 A (IEC) / 15 A (UL)

General ordering data

Type	Order No.	Version	GTIN (EAN)	Qty.	Product data	Packaging
SL-SMT	1774784001	PCB plug-in connector, male	4032248167678	350 pc(s).	IEC: 400 V / 19 A UL: 300 V / 15 A	Tape
5.08/04/90		header, open side, Reflow solder connection, 5.08 mm, No. of poles: 4, 90°, Solder pin length (l): 1.5 mm, tinned, Black, Tape				

SL-SMT 5.08/180 Box

High-temperature-resistant, straight, open ended male
header. Packed in box or tape. In tape with 1.5 mm solder
pin optimised for automatic assembly. 3.2 mm solder
pin suitable for reflow and wave soldering. These male
connectors provide space for labelling and can be coded.

- 400 V (IEC) / 300 V (UL)
- 19 A (IEC) / 15 A (UL)

General ordering data

Type	Order No.	Version	GTIN (EAN)	Qty.	Product data	Packaging
SL-SMT	1838000000	PCB plug-in connector, male	4032248348060	100 pc(s).	IEC: 400 V / 19 A UL: 300 V / 15 A	Box
5.08/04/180		header, open side, Reflow solder connection, 5.08 mm, No. of poles: 4, 180°, Solder pin length (l): 3.2 mm, tinned, Black, Box				
3.2SN BK BX						
SL-SMT	1775592001	PCB plug-in connector, male	4032248157563	100 pc(s).	IEC: 400 V / 19 A UL: 300 V / 15 A	Box
5.08/04/180		header, open side, Reflow solder connection, 5.08 mm, No. of poles: 4, 180°, Solder pin length (l): 1.5 mm, tinned, Black, Box				
1.5SN BK BX						

**OMNIMATE Signal - series BL/SL 5.08
BLL 5.08/04/90 3.2 SN OR BX**

Weidmüller Interface GmbH & Co. KG
Klingenbergstraße 16
D-32758 Detmold
Germany
Fon: +49 5231 14-0
Fax: +49 5231 14-292083
www.weidmueller.com

Mating connector (fully pluggable)
SLD 5.08/90G

2-tier male header with parallel pin arrangement. The solder pin length is optimised for wave flow soldering. The pin headers provide space for labelling and can be coded.

- 400 V (IEC) / 300 V (UL)
- 11 A (IEC) / 10 A (UL)

General ordering data

Type	Order No.	Version	GTIN (EAN)	Qty.	Product data	Packaging
SLD	1601810000	PCB plug-in connector, male	4008190105105	50 pc(s).	IEC: 400 V / 11 A	Box
5.08/08/90G		header, closed side, Solder connection, 5.08 mm, No. of poles: 8, 90°, Solder pin length (l): 3.2 mm, tinned,			UL: 300 V / 10 A	
3.2SN OR BX		Orange, Box				

SL-SMT 5.08/180G Tape

High-temperature-resistant male header, packed in box or tape. In tape with 1.5 mm solder pin optimised for automatic assembly. 3.2 mm solder pin suitable for reflow and wave soldering. These male connectors provide space for labelling and can be coded.

- 400 V (IEC) / 300 V (UL)
- 19 A (IEC) / 15 A (UL)

General ordering data

Type	Order No.	Version	GTIN (EAN)	Qty.	Product data	Packaging
SL-SMT	1775944001	PCB plug-in connector, male	4032248160129	250 pc(s).	IEC: 400 V / 19 A	Tape
5.08/04/180G		header, closed side, Reflow solder connection, 5.08 mm, No. of poles: 4, 180°, Solder pin length (l): 1.5 mm, tinned, Black, Tape			UL: 300 V / 15 A	
1.5 SN BK RL						

**OMNIMATE Signal - series BL/SL 5.08
BLL 5.08/04/90 3.2 SN OR BX**

Weidmüller Interface GmbH & Co. KG
Klingenbergstraße 16
D-32758 Detmold
Germany
Fon: +49 5231 14-0
Fax: +49 5231 14-292083
www.weidmueller.com

Mating connector (fully pluggable)
SL 5.08/180

Male connectors with straight outlet direction. The solder pin length is optimised for wave flow soldering. The pin headers provide space for labelling and can be coded.

- 400 V (IEC) / 300 V (UL)
- 18 A (IEC) / 15 A (UL)

General ordering data

Delivery status Available until	Type	Order No.	Version	GTIN (EAN)	Qty.
This article will no longer be available in the future.	SL 5.08/04/180 3.2 SN OR BX	1517460000	PCB plug-in connector, male header, open side, Solder connection, 5.08 mm, No. of poles: 4, 180°, Solder pin length (l): 3.2 mm, tinned, Orange, Box	4008190042011	100 pc(s).

SL-SMT 5.08/180 Tape

High-temperature-resistant, straight, open ended male header. Packed in box or tape. In tape with 1.5 mm solder pin optimised for automatic assembly. 3.2 mm solder pin suitable for reflow and wave soldering. These male connectors provide space for labelling and can be coded.

- 400 V (IEC) / 300 V (UL)
- 19 A (IEC) / 15 A (UL)

General ordering data

Type	Order No.	Version	GTIN (EAN)	Qty.	Product data	Packaging
SL-SMT 5.08/04/180 1.5 SN BK RL	1775594001	PCB plug-in connector, male header, open side, Reflow solder connection, 5.08 mm, No. of poles: 4, 180°, Solder pin length (l): 1.5 mm, tinned, Black, Tape	4032248159505	250 pc(s).	IEC: 400 V / 19 A UL: 300 V / 15 A	Tape

**OMNIMATE Signal - series BL/SL 5.08
BLL 5.08/04/90 3.2 SN OR BX**

Weidmüller Interface GmbH & Co. KG
Klingenbergstraße 16
D-32758 Detmold
Germany
Fon: +49 5231 14-0
Fax: +49 5231 14-292083
www.weidmueller.com

Mating connector (fully pluggable)
SLD 5.08/180G

2-tier male header with parallel pin arrangement. The solder pin length is optimised for wave flow soldering. The pin headers provide space for labelling and can be coded.

- 400 V (IEC) / 300 V (UL)
- 11 A (IEC) / 10 A (UL)

General ordering data

Type	Order No.	Version	GTIN (EAN)	Qty.	Product data	Packaging
SLD	1602410000	PCB plug-in connector, male	4008190000608	50 pc(s).	IEC: 400 V / 11 A	Box
5.08/08/180G		header, closed side, Solder connection, 5.08 mm, No. of poles: 8, 180°, Solder pin length (l): 3.2 mm, tinned,			UL: 300 V / 10 A	
3.2SN OR BX		Orange, Box				

SL-SMT 5.08/90G Tape

High-temperature-resistant male header, packed in box or tape. In tape with 1.5 mm solder pin optimised for automatic assembly. 3.2 mm solder pin suitable for reflow and wave soldering. These male connectors provide space for labelling and can be coded.

- 400 V (IEC) / 300 V (UL)
- 19 A (IEC) / 15 A (UL)

General ordering data

Type	Order No.	Version	GTIN (EAN)	Qty.	Product data	Packaging
SL-SMT	1775024001	PCB plug-in connector, male	4032248167746	350 pc(s).	IEC: 400 V / 19 A	Tape
5.08/04/90G		header, closed side, Reflow solder connection, 5.08 mm, No. of poles: 4, 90°, Solder pin length (l): 1.5 mm, tinned, Black, Tape			UL: 300 V / 15 A	
1.5 SN BK RL						

**OMNIMATE Signal - series BL/SL 5.08
BLL 5.08/04/90 3.2 SN OR BX**

Weidmüller Interface GmbH & Co. KG
 Klingenbergstraße 16
 D-32758 Detmold
 Germany
 Fon: +49 5231 14-0
 Fax: +49 5231 14-292083
 www.weidmueller.com

Mating connector (conditionally pluggable)
SL-SMT 5.00/90LF Tape

High-temperature-resistant male header, packed in box or tape. In tape with 1.5 mm solder pin optimised for automatic assembly. 3.2 mm solder pin suitable for reflow and wave soldering. These male connectors provide space for labelling and can be coded.

- 400 V (IEC) / 300 V (UL)
- 19 A (IEC) / 15 A (UL)

General ordering data

Type	Order No.	Version	GTIN (EAN)	Qty.	Product data	Packaging
SL-SMT	1797770000	PCB plug-in connector,	4032248239771	350 pc(s).	IEC: 400 V / 19 A	Tape
5.00/04/90LF		male header, Solder flange,			UL: 300 V / 15 A	
1.5SN BK RL		Reflow solder connection,				
		5.00 mm, No. of poles: 4,				
		90°, Solder pin length (l):				
		1.5 mm, tinned, Black, Tape				

SL-SMT 5.00/90LF Box

High-temperature-resistant male header, packed in box or tape. In tape with 1.5 mm solder pin optimised for automatic assembly. 3.2 mm solder pin suitable for reflow and wave soldering. These male connectors provide space for labelling and can be coded.

- 400 V (IEC) / 300 V (UL)
- 19 A (IEC) / 15 A (UL)

General ordering data

Type	Order No.	Version	GTIN (EAN)	Qty.	Product data	Packaging
SL-SMT	1840370000	PCB plug-in connector,	4032248351213	100 pc(s).	IEC: 400 V / 19 A	Box
5.00/04/90LF		male header, Solder flange,			UL: 300 V / 15 A	
3.2SN BK BX		Reflow solder connection,				
		5.00 mm, No. of poles: 4,				
		90°, Solder pin length (l):				
		3.2 mm, tinned, Black, Box				
2014-05-20T09:00:00SL-SMT 5.00/04/90LF 1.5SN BK BX	1797250000	PCB plug-in	4032248238033	100 pc(s).	IEC:	
		connector, male			400	
		header, Solder			V /	
		flange, Reflow			19	
		solder connection,			A	
		5.00 mm, No.			UL:	
		of poles: 4, 90°,			300	
		Solder pin length			V /	
		(l): 1.5 mm,			15	
		tinned, Black, Box			A	

OMNIMATE Signal - series BL/SL 5.08 BLL 5.08/04/90 3.2 SN OR BX

Weidmüller Interface GmbH & Co. KG
 Klingenbergstraße 16
 D-32758 Detmold
 Germany
 Fon: +49 5231 14-0
 Fax: +49 5231 14-292083
 www.weidmuller.com

Mating connector (conditionally pluggable)

SLZF 5.08/180B



Male plugs with tension-clamp wire connection. The male plugs provide space for labelling and can be coded.

- 0.2 - 2.5 mm² (IEC) / 26 - 14 AWG (UL)
- 400 V (IEC) / 300 V (UL)
- 23 A (IEC) / 15 A (UL)

General ordering data

Delivery status	Available until	Type	Order No.	Version	GTIN (EAN)	Qty.
This article will no longer be available in the future.	2017-12-31T00:00:00+01:00	SLZF 5.08/04/180B SN OR BX	1710230000	PCB plug-in connector, male plug, 5.08 mm, No. of poles: 4, 180°, Tension clamp connection, Clamping range, rated connection, max.: 3.31 mm ² , Box	4008190319540	100 pc(s)

SL 5.08/90B



Male connectors with 90° outlet direction. The solder pin length is optimised for wave flow soldering. The pin headers provide space for labelling and can be coded.

- 400 V (IEC) / 300 V (UL)
- 18 A (IEC) / 15 A (UL)

General ordering data

Delivery status	Available until	Type	Order No.	Version	GTIN (EAN)	Qty.
This article will no longer be available in the future.	2017-12-31T00:00:00+01:00	SL 5.08/04/90B 3.2SN OR BX	1510560000	PCB plug-in connector, male header, Dovetails for fixing blocks, Solder connection, 5.08 mm, No. of poles: 4, Solder pin length (l): 3.2 mm, tinned, Orange, Box	4008190046842	100 pc(s)

**OMNIMATE Signal - series BL/SL 5.08
BLL 5.08/04/90 3.2 SN OR BX**

Weidmüller Interface GmbH & Co. KG
Klingenbergstraße 16
D-32758 Detmold
Germany
Fon: +49 5231 14-0
Fax: +49 5231 14-292083
www.weidmueller.com

Mating connector (conditionally pluggable)
SL 5.08/135B

Male connectors with 135° outlet direction. The solder pin length is optimised for wave flow soldering. The pin headers provide space for labelling and can be coded.

- 400 V (IEC) / 300 V (UL)
- 17 A (IEC) / 15 A (UL)

General ordering data

Type	Order No.	Version	GTIN (EAN)	Qty.	Product data	Packaging
SL 5.08/04/135B 3.2SN OR BX	1605550000	PCB plug-in connector, male header, Dovetails for fixing blocks, Solder connection, 5.08 mm, No. of poles: 4, 135°, Solder pin length (l): 3.2 mm, tinned, Orange, Box	4008190051693	100 pc(s).	IEC: 400 V / 17 A UL: 300 V / 15 A	Box

SL 5.08/180B

Male connectors with straight outlet direction. The solder pin length is optimised for wave flow soldering. The pin headers provide space for labelling and can be coded.

- 400 V (IEC) / 300 V (UL)
- 18 A (IEC) / 15 A (UL)

General ordering data

Delivery status	Available until	Type	Order No.	Version	GTIN (EAN)	Qty.
This article will no longer be available in the future.	2017-12-31T00:00:00+01:00	SL 5.08/04/180B 3.2SN OR BX	1519760000	PCB plug-in connector, male header, Dovetails for fixing blocks, Solder connection, 5.08 mm, No. of poles: 4, Solder pin length (l): 3.2 mm, tinned, Orange, Box	4008190098483	100 pc(s).

**OMNIMATE Signal - series BL/SL 5.08
BLL 5.08/04/90 3.2 SN OR BX**

Weidmüller Interface GmbH & Co. KG
Klingenbergstraße 16
D-32758 Detmold
Germany
Fon: +49 5231 14-0
Fax: +49 5231 14-292083
www.weidmueller.com

Mating connector (conditionally pluggable)
SL-SMT 5.08/180LF Box

High-temperature-resistant male header, packed in box or tape. In tape with 1.5 mm solder pin optimised for automatic assembly. 3.2 mm solder pin suitable for reflow and wave soldering. These male connectors provide space for labelling and can be coded.

- 400 V (IEC) / 300 V (UL)
- 19 A (IEC) / 15 A (UL)

General ordering data

Type	Order No.	Version	GTIN (EAN)	Qty.	Product data	Packaging
SL-SMT 5.08/04/180LF 1.5SN BK BX	1776382001	PCB plug-in connector, male header, Solder flange, Reflow solder connection, 5.08 mm, No. of poles: 4, 180°, Solder pin length (l): 1.5 mm, tinned, Black, Box	4032248159161	100 pc(s).	IEC: 400 V / 19 A UL: 300 V / 15 A	Box
SL-SMT 5.08/04/180LF 3.2SN BK BX	1838460000	PCB plug-in connector, male header, Solder flange, Reflow solder connection, 5.08 mm, No. of poles: 4, 180°, Solder pin length (l): 3.2 mm, tinned, Black, Box	4032248348527	100 pc(s).	IEC: 400 V / 19 A UL: 300 V / 15 A	Box

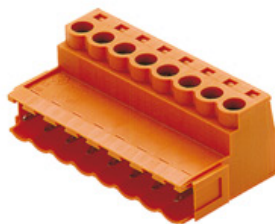
SLS 5.08/180B

Male plugs with clamping-yoke screw wire-connect system. The male plugs provide space for labelling and can be coded.

- 0.2 - 2.5 mm² (IEC) / 26 - 12 AWG (UL)
- 400 V (IEC) / 300 V (UL)
- 21.5 A (IEC) / 15 A (UL)

General ordering data

Type	Order No.	Version	GTIN (EAN)	Qty.	Product data	Packaging
SLS 5.08/04/180B SN OR BX	1627260000	PCB plug-in connector, male plug, 5.08 mm, No. of poles: 4, 180°, Clamping yoke connection, Clamping range, rated connection, max.: 3.31 mm ² , Box	4008190199777	100 pc(s).	IEC: 400 V / 21.5 A / 0.2 - 2.5 mm ² UL: 300 V / 14 A / AWG 26 - AWG 12	Box

**OMNIMATE Signal - series BL/SL 5.08
BLL 5.08/04/90 3.2 SN OR BX**

Weidmüller Interface GmbH & Co. KG
Klingenbergstraße 16
D-32758 Detmold
Germany
Fon: +49 5231 14-0
Fax: +49 5231 14-292083
www.weidmueller.com

Mating connector (conditionally pluggable)
SL-SMT 5.08/180F Box

High-temperature-resistant male header, packed in box or tape. In tape with 1.5 mm solder pin optimised for automatic assembly. 3.2 mm solder pin suitable for reflow and wave soldering. These male connectors provide space for labelling and can be coded.

- 400 V (IEC) / 300 V (UL)
- 19 A (IEC) / 15 A (UL)

General ordering data

Type	Order No.	Version	GTIN (EAN)	Qty.	Product data	Packaging
SL-SMT 5.08/04/180F 1.5SN BK BX	1830100000	PCB plug-in connector, male header, Flange, Reflow solder connection, 5.08 mm, No. of poles: 4, 180°, Solder pin length (l): 1.5 mm, tinned, Black, Box	4032248336210	100 pc(s).	IEC: 400 V / 19 A UL: 300 V / 15 A	Box
SL-SMT 5.08/04/180F 3.2SN BK BX	1837870000	PCB plug-in connector, male header, Flange, Reflow solder connection, 5.08 mm, No. of poles: 4, 180°, Solder pin length (l): 3.2 mm, tinned, Black, Box	4032248347681	100 pc(s).	IEC: 400 V / 19 A UL: 300 V / 15 A	Box

SLDV-THR 5.08/180F

High-temperature resistant, double level, laterally offset, male connector with flange or solder flange. 1.5 mm solder pin is suitable for reflow soldering. 3.2 mm solder pin suitable for reflow and wave soldering. The pin headers provide space for labelling and can be coded.

- 400 V (IEC) / 300 V (UL)
- 15 A (IEC) / 10 A (UL)

General ordering data

Type	Order No.	Version	GTIN (EAN)	Qty.	Product data	Packaging
SLDV-THR 5.08/08/180F 3.2SN BK BX	1828790000	PCB plug-in connector, male header, Flange, Reflow solder connection, 5.08 mm, No. of poles: 8, 180°, Solder pin length (l): 3.2 mm, tinned, Black, Box	4032248335473	50 pc(s).	IEC: 400 V / 15 A UL: 300 V / 10 A	Box
SLDV-THR 5.08/08/180F 1.5SN BK BX	1828910000	PCB plug-in connector, male header, Flange, Reflow solder connection, 5.08 mm, No. of poles: 8, 180°	4032248335602	50 pc(s).	IEC: 400 V / 15 A UL: 300 V / 10 A	Box

**OMNIMATE Signal - series BL/SL 5.08
BLL 5.08/04/90 3.2 SN OR BX**

Weidmüller Interface GmbH & Co. KG
 Klingenbergstraße 16
 D-32758 Detmold
 Germany
 Fon: +49 5231 14-0
 Fax: +49 5231 14-292083
 www.weidmueller.com

Mating connector (conditionally pluggable)

Solder pin length (l): 1.5
 mm, tinned, Black, Box

SLZF 5.08/180FI

Male plugs with tension-clamp wire connection. The male plugs provide space for labelling and can be coded.

- 0.2 - 2.5 mm² (IEC) / 26 - 14 AWG (UL)
- 400 V (IEC) / 300 V (UL)
- 23 A (IEC) / 15 A (UL)

General ordering data

Delivery status Available until	Type	Order No.	Version	GTIN (EAN)	Qty.
This article will no longer be available in the future.	SLZF 5.08/04/180FI SN OR BX	1846530000	PCB plug-in connector, male plug, 5.08 mm, No. of poles: 4, 180°, Tension clamp connection, Clamping range, rated connection, max.: 3.31 mm ² , Box	4032248362837	100 pc(s)

SLS 5.08/180F

Male plugs with clamping-yoke screw wire-connect system. The male plugs provide space for labelling and can be coded.

- 0.2 - 2.5 mm² (IEC) / 26 - 12 AWG (UL)
- 400 V (IEC) / 300 V (UL)
- 21.5 A (IEC) / 15 A (UL)

General ordering data

Type	Order No.	Version	GTIN (EAN)	Qty.	Product data	Packaging
SLS 5.08/04/180F SN OR BX	1846380000	PCB plug-in connector, male plug, 5.08 mm, No. of poles: 4, 180°, Clamping yoke connection, Clamping range, rated connection, max.: 3.31 mm ² , Box	4032248362080	60 pc(s)	IEC: 400 V / 21.5 A / 0.2 - 2.5 mm ² UL: 300 V / 14 A / AWG 26 - AWG 12	Box

**OMNIMATE Signal - series BL/SL 5.08
BLL 5.08/04/90 3.2 SN OR BX**

Weidmüller Interface GmbH & Co. KG
Klingenbergstraße 16
D-32758 Detmold
Germany
Fon: +49 5231 14-0
Fax: +49 5231 14-292083
www.weidmueller.com

Mating connector (conditionally pluggable)
SLDV-THR 5.08/180FLF

High-temperature resistant, double level, laterally offset, male connector with flange or solder flange. 1.5 mm solder pin is suitable for reflow soldering. 3.2 mm solder pin suitable for reflow and wave soldering. The pin headers provide space for labelling and can be coded.

- 400 V (IEC) / 300 V (UL)
- 15 A (IEC) / 10 A (UL)

General ordering data

Type	Order No.	Version	GTIN (EAN)	Qty.	Product data	Packaging
SLDV-THR 5.08/08/180FLF 1.5SN BK BX	1829150000	PCB plug-in connector, male header, Flange / Solder flange, Reflow solder connection, 5.08 mm, No. of poles: 8, 180°, Solder pin length (l): 1.5 mm, tinned, Black, Box	4032248335848	50 pc(s).	IEC: 400 V / 15 A UL: 300 V / 10 A	Box
SLDV-THR 5.08/08/180FLF 3.2SN BK BX	1829030000	PCB plug-in connector, male header, Flange / Solder flange, Reflow solder connection, 5.08 mm, No. of poles: 8, 180°, Solder pin length (l): 3.2 mm, tinned, Black, Box	4032248335725	50 pc(s).	IEC: 400 V / 15 A UL: 300 V / 10 A	Box

SL-SMT 5.08/90LF Tape

High-temperature-resistant male header, packed in box or tape. In tape with 1.5 mm solder pin optimised for automatic assembly. 3.2 mm solder pin suitable for reflow and wave soldering. These male connectors provide space for labelling and can be coded.

- 400 V (IEC) / 300 V (UL)
- 19 A (IEC) / 15 A (UL)

General ordering data

Type	Order No.	Version	GTIN (EAN)	Qty.	Product data	Packaging
SL-SMT 5.08/04/90LF 1.5 SN BK RL	1775254001	PCB plug-in connector, male header, Solder flange, Reflow solder connection, 5.08 mm, No. of poles: 4, 90°, Solder pin length (l): 1.5 mm, tinned, Black, Tape	4032248167807	350 pc(s).	IEC: 400 V / 19 A UL: 300 V / 15 A	Tape

**OMNIMATE Signal - series BL/SL 5.08
BLL 5.08/04/90 3.2 SN OR BX**

Weidmüller Interface GmbH & Co. KG
Klingenbergstraße 16
D-32758 Detmold
Germany
Fon: +49 5231 14-0
Fax: +49 5231 14-292083
www.weidmueller.com

Mating connector (conditionally pluggable)
SLS 5.08TB KF35

Male plugs with clamping-yoke screw wire-connect system. With clip-on feet for attaching the male plugs on rail. The male plugs provide space for labelling and can be coded.

- 0.2 - 2.5 mm² (IEC) / 26 - 12 AWG (UL)
- 400 V (IEC) / 300 V (UL)
- 21.5 A (IEC) / 15 A (UL)

General ordering data

Type	Order No.	Version	GTIN (EAN)	Qty.	Product data	Packaging
SLS 5.08/04/180TB KF SN OR BX	1846130000	PCB plug-in connector, male plug, 5.08 mm, No. of poles: 4, 180°, Clamping yoke connection, Clamping range, rated connection, max.: 3.31 mm ² , Box	4032248362417 20 pc(s).		IEC: 400 V / 21.5 A / 0.2 - 2.5 mm ² UL: 300 V / 14 A / AWG 26 - AWG 12	Box

SL-SMT 5.08/180LF Tape

High-temperature-resistant male header, packed in box or tape. In tape with 1.5 mm solder pin optimised for automatic assembly. 3.2 mm solder pin suitable for reflow and wave soldering. These male connectors provide space for labelling and can be coded.

- 400 V (IEC) / 300 V (UL)
- 19 A (IEC) / 15 A (UL)

General ordering data

Type	Order No.	Version	GTIN (EAN)	Qty.	Product data	Packaging
SL-SMT 5.08/04/180LF 1.5 SN BK RL	1776384001	PCB plug-in connector, male header, Solder flange, Reflow solder connection, 5.08 mm, No. of poles: 4, 180°, Solder pin length (l): 1.5 mm, tinned, Black, Tape	4032248163502 250 pc(s).		IEC: 400 V / 19 A UL: 300 V / 15 A	Tape

**OMNIMATE Signal - series BL/SL 5.08
BLL 5.08/04/90 3.2 SN OR BX**

Weidmüller Interface GmbH & Co. KG
Klingenbergstraße 16
D-32758 Detmold
Germany
Fon: +49 5231 14-0
Fax: +49 5231 14-292083
www.weidmueller.com

Mating connector (conditionally pluggable)
SLZF 5.08/180F

Male plugs with tension-clamp wire connection. The male plugs provide space for labelling and can be coded.

- 0.2 - 2.5 mm² (IEC) / 26 - 14 AWG (UL)
- 400 V (IEC) / 300 V (UL)
- 23 A (IEC) / 15 A (UL)

General ordering data

Delivery status	Available until	Type	Order No.	Version	GTIN (EAN)	Qty.
This article will no longer be available in the future.	2017-12-31T00:00:00+01:00	SLZF 5.08/04/180F SN OR BX	1846950000	PCB plug-in connector, male plug, 5.08 mm, No. of poles: 4, 180°, Tension clamp connection, Clamping range, rated connection, max.: 3.31 mm ² , Box	4032248363124	100 pc(s).

SLS 5.08TB RF15

Male plugs with clamping-yoke screw wire-connect system. With clip-on feet for attaching the male plugs on rail. The male plugs provide space for labelling and can be coded.

- 0.2 - 2.5 mm² (IEC) / 26 - 12 AWG (UL)
- 400 V (IEC) / 300 V (UL)
- 21.5 A (IEC) / 15 A (UL)

General ordering data

Type	Order No.	Version	GTIN (EAN)	Qty.	Product data	Packaging
SLS 5.08/04/180TB RF15 SN OR BX	1846050000	PCB plug-in connector, male plug, 5.08 mm, No. of poles: 4, 180°, Clamping yoke connection, Clamping range, rated connection, max.: 3.31 mm ² , Box	4032248362332	20 pc(s).	IEC: 400 V / 21.5 A / 0.2 - 2.5 mm ² UL: 300 V / 14 A / AWG 26 - AWG 12	Box

**OMNIMATE Signal - series BL/SL 5.08
BLL 5.08/04/90 3.2 SN OR BX**

Weidmüller Interface GmbH & Co. KG
Klingenbergstraße 16
D-32758 Detmold
Germany
Fon: +49 5231 14-0
Fax: +49 5231 14-292083
www.weidmueller.com

Mating connector (conditionally pluggable)
SLT 5.08B

Male plugs with screw TOP wire connection. The male plug provides space for labelling and can be coded.

- 0.2 - 2.5 mm² (IEC) / 26 - 14 AWG (UL)
- 400 V (IEC) / 300 V (UL)
- 16 A (IEC) / 10 A (UL)

General ordering data

Type	Order No.	Version	GTIN (EAN)	Qty.	Product data	Packaging
SLT 5.08/04/180B SN OR BX	1611730000	PCB plug-in connector, male plug, 5.08 mm, No. of poles: 4, 180°, TOP connection, Clamping range, rated connection, max.: 2.5 mm ² , Box	4008190192617	100 pc(s).	IEC: 400 V / 16 A / 0.2 - 2.5 mm ² UL: 300 V / 15 A / AWG 26 - AWG 14	Box

SLZF 5.08/270B

Male plugs with tension-clamp wire connection. The male plugs provide space for labelling and can be coded.

- 0.2 - 2.5 mm² (IEC) / 26 - 14 AWG (UL)
- 400 V (IEC) / 300 V (UL)
- 23 A (IEC) / 15 A (UL)

General ordering data

Delivery status Available until	Type	Order No.	Version	GTIN (EAN)	Qty.
This article will no longer be available in the future.	SLZF 5.08/04/270B SN OR BX	1706160000	PCB plug-in connector, male plug, 5.08 mm, No. of poles: 4, 270°, Tension clamp connection, Clamping range, rated connection, max.: 3.31 mm ² , Box	4032248119721	100 pc(s).

**OMNIMATE Signal - series BL/SL 5.08
BLL 5.08/04/90 3.2 SN OR BX**

Weidmüller Interface GmbH & Co. KG
Klingenbergstraße 16
D-32758 Detmold
Germany
Fon: +49 5231 14-0
Fax: +49 5231 14-292083
www.weidmueller.com

Mating connector (conditionally pluggable)
SL-SMT 5.08/90F Box

High-temperature-resistant male header, packed in box or tape. In tape with 1.5 mm solder pin optimised for automatic assembly. 3.2 mm solder pin suitable for reflow and wave soldering. These male connectors provide space for labelling and can be coded.

- 400 V (IEC) / 300 V (UL)
- 19 A (IEC) / 15 A (UL)

General ordering data

Type	Order No.	Version	GTIN (EAN)	Qty.	Product data	Packaging
SL-SMT	1837650000	PCB plug-in connector, male	4032248347469	100 pc(s).	IEC: 400 V / 19 A	Box
5.08/04/90F		header, Flange, Reflow			UL: 300 V / 15 A	
3.2SN BK BX		solder connection, 5.08 mm, No. of poles: 4, 90°, Solder pin length (l): 3.2 mm, tinned, Black, Box				

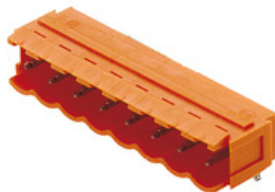
SL 5.00/90B

Male connectors with 90° outlet direction. The solder pin length is optimised for wave flow soldering. The pin headers provide space for labelling and can be coded.

- 400 V (IEC) / 300 V (UL)
- 18 A (IEC) / 15 A (UL)

General ordering data

Type	Order No.	Version	GTIN (EAN)	Qty.	Product data	Packaging
SL	1580880000	PCB plug-in connector, male	4008190044060	100 pc(s).	IEC: 400 V / 18 A	Box
5.00/04/90B		header, Dovetails for fixing			UL: 300 V / 15 A	
3.2SN OR BX		blocks, Solder connection, 5.00 mm, No. of poles: 4, 90°, Solder pin length (l): 3.2 mm, tinned, Orange, Box				

OMNIMATE Signal - series BL/SL 5.08 BLL 5.08/04/90 3.2 SN OR BX

Weidmüller Interface GmbH & Co. KG
 Klingenbergstraße 16
 D-32758 Detmold
 Germany
 Fon: +49 5231 14-0
 Fax: +49 5231 14-292083
 www.weidmueller.com

Mating connector (conditionally pluggable)

SLS 5.08/180FI

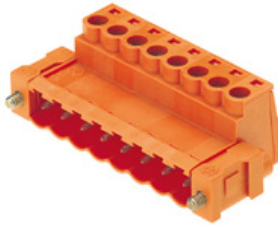

Male plugs with clamping-yoke screw wire-connect system. The male plugs provide space for labelling and can be coded.

- 0.2 - 2.5 mm² (IEC) / 26 - 12 AWG (UL)
- 400 V (IEC) / 300 V (UL)
- 21.5 A (IEC) / 15 A (UL)

General ordering data

Type	Order No.	Version	GTIN (EAN)	Qty.	Product data	Packaging
SLS 5.08/04/180FI SN OR BX	1846230000	PCB plug-in connector, male plug, 5.08 mm, No. of poles: 4, 180°, Clamping yoke connection, Clamping range, rated connection, max.: 3.31 mm ² , Box	4032248362516 60 pc(s).		IEC: 400 V / 21.5 A / 0.2 - 2.5 mm ² UL: 300 V / 14 A / AWG 26 - AWG 12	Box

SLZF 5.08/90B



Male plugs with tension-clamp wire connection. The male plugs provide space for labelling and can be coded.

- 0.2 - 2.5 mm² (IEC) / 26 - 14 AWG (UL)
- 400 V (IEC) / 300 V (UL)
- 23 A (IEC) / 15 A (UL)

General ordering data

Delivery status Available until	Type	Order No.	Version	GTIN (EAN)	Qty.
This article will no longer be available in the future.	SLZF 5.08/04/90B SN OR BX	1673570000	PCB plug-in connector, male plug, 5.08 mm, No. of poles: 4, 90°, Tension clamp connection, Clamping range, rated connection, max.: 3.31 mm ² , Box	4008190435288	100 pc(s).

**OMNIMATE Signal - series BL/SL 5.08
BLL 5.08/04/90 3.2 SN OR BX**

Weidmüller Interface GmbH & Co. KG
 Klingenbergstraße 16
 D-32758 Detmold
 Germany
 Fon: +49 5231 14-0
 Fax: +49 5231 14-292083
 www.weidmueller.com

Mating connector (conditionally pluggable)
SL-SMT 5.08/90LF Box

High-temperature-resistant male header, packed in box or tape. In tape with 1.5 mm solder pin optimised for automatic assembly. 3.2 mm solder pin suitable for reflow and wave soldering. These male connectors provide space for labelling and can be coded.

- 400 V (IEC) / 300 V (UL)
- 19 A (IEC) / 15 A (UL)

General ordering data

Type	Order No.	Version	GTIN (EAN)	Qty.	Product data	Packaging
SL-SMT 5.08/04/90LF 3.2SN BK BX	1780430000	PCB plug-in connector, male header, Solder flange, Reflow solder connection, 5.08 mm, No. of poles: 4, 90°, Solder pin length (l): 3.2 mm, tinned, Black, Box	4032248165759	100 pc(s).	IEC: 400 V / 19 A UL: 300 V / 15 A	Box
SL-SMT 5.08/04/90LF 1.5SN BK BX	1775252001	PCB plug-in connector, male header, Solder flange, Reflow solder connection, 5.08 mm, No. of poles: 4, 90°, Solder pin length (l): 1.5 mm, tinned, Black, Box	4032248157235	100 pc(s).	IEC: 400 V / 19 A UL: 300 V / 15 A	Box

Recommended wave soldering profiles

Weidmüller Interface GmbH & Co. KG
 Klingenbergstraße 16
 D-32758 Detmold
 Germany
 Fon: +49 5231 14-0
 Fax: +49 5231 14-292083
 www.weidmueller.com

Single Wave:

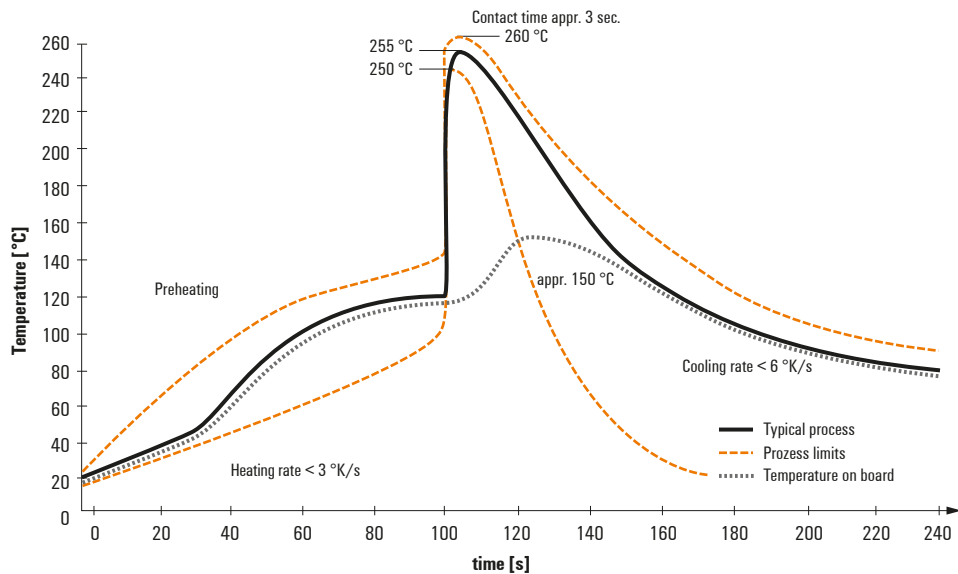

Double Wave:

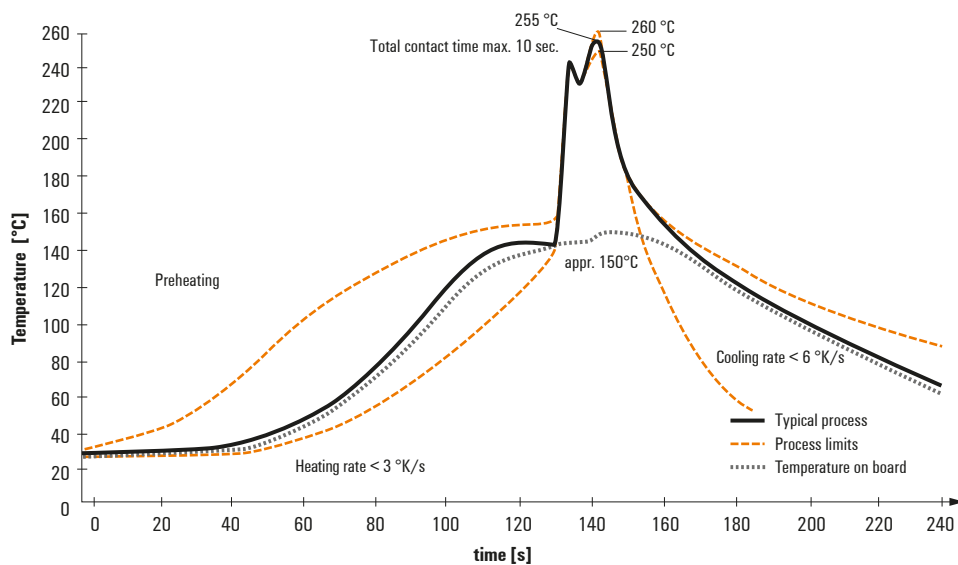

Wave soldering profiles

Wired connection elements should be processed in accordance with the DIN EN 61760-1 standard. We have included two recommendations for practical wave soldering profiles, with which Weidmüller PCB terminals and connectors are qualified.

When choosing a suitable profile for your application, the following factors also need to be considered:

- PCB thickness
- Proportion of Cu in the layers
- Single/double-sided assembly
- Product range
- Heating and cooling rates

The single and double wave profiles each indicate the recommended operating range, including the maximum soldering temperature of 260°C. In practice, the maximum soldering temperature is quite often well below the above maximum profile.

Addresses worldwide

Let's connect.

- AE United Arab Emirates**
Weidmüller Middle East FZE
Warehouse Q3-79
SAIF-Zone
P.O. BOX 8591
Sharjah
Tel. +971 65572723
Fax +971 65572724
wme.info@weidmueller.com
- AO Angola**
Please contact
Phambili Interface (Pty) Ltd.
South Africa
- AR Argentina**
CPI SA
Bauness 2660
C1431DOF Buenos Aires
Tel. +54 11 4523 8008
Fax +54 11 4522 0546
info@cpi.com.ar
www.cpi.com.ar
- AT Austria**
Weidmüller GmbH
IZ NOE Süd Straße 2b, Obj
M 59
2355 Wiener Neudorf
Tel. +43 2236 67080
Fax +43 2236 6708-899
office.at@weidmueller.com
www.weidmueller.com
- AU Australia**
Weidmüller Pty. Ltd.
PO BOX 6944
Huntingwood 2148
Huntingwood Drive 43
Huntingwood NSW 2148
Tel. +61 2 9671 9999
Fax +61 2 9671 9911
info@weidmuller.com.au
www.weidmuller.com.au
- AZ Azerbaijan**
Representative Office
Rashad Mahmudov
Demirchi Tower, 4th floor
37, Khojali ave.
AZ 1025 Baku
Tel. +994 12 488 80 36
Fax +994 12 488 80 37
rashad.mahmudov@weidmueller.com
- BA Bosnia and Herzegovina**
Please contact
our Representative Office
Weidmüller Interface GmbH
& Co. KG
Serbia
or
BIG electric d.o.o
Mladena Stojanovića 117A
78000 Banja Luka
Tel. +387 51926277
Fax +387 51926277
bigelectric@blic.net
www.bigelectric.ba
- BE Belgium**
Weidmüller Benelux B. V.
Mechelsesteenweg 519 bus
6 en 7
1930 Nossegem
Tel. +32 2 752 40 70
Fax +32 2 751 36 06
info@weidmueller.be
www.weidmueller.be
- BG Bulgaria**
Weid-Bul EOOD
Bul. „Kliment Ohridski“ 13
1756 Sofia
Tel. +359 2 963 2560
Fax +359 2 963 1098
sofia@weidbul.com
www.weidbul.com
- BH Bahrain**
Khayber Trading Company
P.O. Box 1976
Manama
Tel. +973 720747
Fax +973 720331
khayber@batelco.com.bh
- BR Brazil**
Weidmüller Conexel do Brasil
Conexões Elétricas Ltda.
Av. Presidente Juscelino, 642
- Piraporinha
Diadema, São Paulo
09950-370
Tel. +55 (11) 4366-9600
Fax +55 (11) 4362-1677
vendas@weidmueller.com.br
www.weidmueller.com.br
- BW Botswana**
Please contact
Phambili Interface (Pty) Ltd.
South Africa
- BY Belarus**
TECHNIKON Ltd.
Nezavisimosti pr. 177-9
220125 Minsk
Tel. +375 17 393-11-77
Fax +375 17 3930080
wm@technikon.by
- CA Canada**
W Interconnections Canada
Inc.
10 Spy Court
Markham Ontario L3R 5H6
Tel. +1 (905) 475-1507
Ext. 9836
Fax +1 (905) 475-2798
support@weidmuller.ca
www.weidmuller.ca
- CG Congo**
Please contact
Phambili Interface (Pty) Ltd.
South Africa
- CH Switzerland**
Weidmüller Schweiz AG
Rundbuckstraße 2
8212 Neuhausen am
Rheinfall SH
Tel. +41 52 674 07 07
Fax +41 52 674 07 08
info@weidmueller.ch
www.weidmueller.ch
- CL Chile**
ATS-INTECH
Maria Luisa Santander 0475
Santiago
Providencia 7500859
Tel. +56 2 341 1271
Fax +56 2 341 1275
felipe@atsintech.com
www.atsintech.com
CPI CHILE LTDA
Av. Presidente Frei Montalva
6001, 47 complejo el cortijo
Santiago - Conchalí
Tel. +562 963 8440
Fax +562 963 8440
cpi@cpichile.cl
www.cpichile.cl
- CN China**
Weidmüller Interface
(Shanghai) Co. Ltd.
100 Yutong Road
25 F, BM Intercontinental
Business Center
200070 Shanghai
Tel. +86 21-22195008
Fax +86 21-22195009
customer.hotline@weidmueller.com.cn
www.cnweidmuller.com
- CO Colombia**
Automatización Avanzada
S. A.
Carrera 97 No., 24 c - 23
Bodega 4
110911 Bogotá-D.C.
Tel. +57 (1) 547-8510
Fax +57 (1) 422-3044
comercial@automatizacionavanzada.com
www.automatizacionavanzada.com
- CR Costa Rica**
ELVATRON S. A.
la Uruca 400 Norte Banco
Costa Rica
San Jose Costa Rica
Tel. +506 2961-060
Fax +506 5200-609
dirk.haase@elvatron.com
www.elvatron.com
- CZ Czech Republic**
Weidmüller s.r.o.
Lomnického 5/1705
140 00 Praha 4
Tel. +420 244 001 400
Fax +420 244 001 499
office@weidmueller.cz
www.weidmueller.cz
- DE Germany**
Weidmüller GmbH & Co. KG
Ohmstraße 9
32758 Detmold
Postfach 30 54
32720 Detmold
Tel. +49 5231 1428-0
Fax +49 5231 1428-116
weidmueller@weidmueller.de
www.weidmueller.de
- DK Denmark**
Weidmüller Danmark
Vallensbækvej 18A
2605 Brøndby
Tel. +45 27747800
kundeservice@weidmuller.dk
www.weidmuller.dk
- EC Ecuador**
Elsystec S. A., Electricidad
Sistemas y Tecnología
Vasco de Contreras N35-25 1
y Mañosa
Quito - Pichincha
Tel. +593 22456510
Fax +593 22456755
Elsystec@uio.satnet.net
- EE Estonia**
Please contact
our Representative Office
Weidmüller Interface GmbH
& Co. KG
Latvia
or
Soots Interface OÜ
Pärnu mnt 142
11317 Tallinn
Tel. +372 609 6933
Fax +372 609 6933
info@sootsinterface.ee
www.sootsinterface.ee
- EG Egypt**
Standard Electric (OMEGA)
87, Mohamed Farid Street
Heliopolis
Cairo
Tel. +202 26229000
Fax +202 26221555
stdelec@rite.com
- ES Spain**
Weidmüller, S. A.
Narcis Monturiol 11-13, Pol.
Ind. Sudoeste
8960 Sant Just
Desvern - Barcelona
Tel. +34 934 803 386
Fax +34 933 718 055
weidmuller@weidmuller.es
www.weidmuller.es
- FI Finland**
Weidmüller Suomi,
Weidmüller Aktiebolagetin
sivillike
Koy Plaza Vivace
Ayritie 6C
FI 1510 Vantaa
Tel. +358 20 7351300
Fax +358 800 114 667
asiakaspalvelu@weidmuller.fi
www.weidmuller.fi
- FR France**
Weidmüller E. U. R. L.
12, Chaussée Jules César
BP 263 Osny
95523 Cergy-Pontoise Cedex
Tel. +33 1 34 24 55 00
Fax +33 1 34 24 55 01
mail@weidmuller.fr
- GB Great Britain**
Weidmüller Ltd.
Klippon House
Centurion Court Office Park,
Meridian East, Meridian
Business Park
Leicester
LE19 1TP
Tel. +44 116 282 3470
Fax +44 116 289 3582
marketing@weidmuller.co.uk
www.weidmuller.co.uk
- GE Georgia**
Please contact
our Representative Office
Rashad Mahmudov
Azerbaijan.
- GR Greece**
G.A. Solutions
Ippokratous 11 Metamorfois
144 52 Athen
Tel. +30 210 2823233
Fax +30 210 2823233
info@weidmuller.gr
www.weidmuller.gr
- GT Guatemala**
Prestelectro, Prestegard
Electro. S.A.
Avenida Petapa 44-22,
Zona 12
Guatemala City
Tel. +502 2442-3346
Fax +502 2476-8945
ventas@preselectro.com
- HK Hong Kong**
Weidmüller (Hong Kong)
Limited Co. Ltd.
Unit 1617, Metropolis Tower
No. 10 Metropolis Drive,
Hungghom, Kowloon
Tel. +852 3154 8088
Fax +852 31548099
Info-hk@weidmueller.com.hk
- HR Croatia**
ElektroPARTNER d.o.o.
Slavonska avenija 24/6
HR-10000 Zagreb
Tel. +385 (1) 6184 793
Fax +385 (1) 6184 795
elektropartner@zg-t.com.hr
www.elektropartner.hr
- HU Hungary**
Weidmüller Kereskedelmi Kft.
Budapest
Gubacsi út 6.
1097
Tel. +36 1 382 7700
Fax +36 1 382 7701
info@weidmueller.hu
www.weidmueller.hu
- ID Indonesia**
PT. Nego Electrindo
Ruko Mega Grosir Cempaka
Mas Blok I No. 20 - 22
Jakarta 10640
Tel. +62 21 42882255
Fax +62 21 42882266
sales@negoelectrindo.co.id
- IE Ireland**
Please contact
Weidmüller Ltd.
Great Britain
- IL Israel**
A. U. Shay Ltd.
23/25, Embar Street
49222 Petach-Tikva
P.O. Box 1 00 49
49222 Petach-Tikva
Tel. +972 3-923-3601
Fax +972 3-923-4601
shay@uriel-shay.com
www.uriel-shay.com
ATEKA Ltd.
4, Ha Tavor lane Industrial
area Segula
49691 Petach-Tikva
P.O. Box 4710
Petach-Tikva
Tel. +972 73-200-1311
Fax +972 3-924 4245
marketing@ateka.co.il
www.ateka.co.il
- IN India**
Representative Office
Weidmüller Electronics India
Pvt. Ltd.
12th Lane North Avenue, Opp
Joggers Park,
Kalyani Nagar, Pune
411 006
Tel. +91 20-41290090
Nitish.Rajan@weidmueller.de
www.weidmueller.com
- IS Iceland**
Samey Automation Center
Lyngas 13
210 Garoabaer
Tel. +354 5 10 5200
Fax +354 5 10 5201
Samey@samey.is
www.samey.is
- IT Italy**
Weidmüller S. r.l.
Via Albert Einstein 4
20092 Cinisello
Balsamo Milano
Tel. +39 02 660681
Fax +39 02 6124945
weidmuller@weidmuller.it
www.weidmuller.it
- JM Jamaica**
Please contact
W Interconnections Inc.
United States
- JO Jordan**
Trans Jordan for Electro
PO Box 33 06 07
Amman
Tel. +962 6 533 2020
Fax +962 6 533 5800
transjordan@batelco.jo
- JP Japan**
Nihon Weidmüller Co. Ltd.
Sphere Tower Tennoz 2-2-8
Higashi-Shinagawa,
Shinagawa-ku
Tokyo
140-0002
Tel. +81 3 6711 5300
Fax +81 3 6711 5333
weidmullerjapan@weidmuller.co.jp
www.weidmuller.co.jp
- KE Kenya**
Please contact
Phambili Interface (Pty) Ltd.
South Africa
- KR Korea**
Weidmüller Korea Co. Ltd.
9th floor, Wonbang B/D
Samsseong 2-Dong, Gangnam-Gu
Seoul 143-42
Tel. +82 2-516-0003
Fax +82 2-516-0090
info@weidmuller.co.kr
www.weidmuller.co.kr
- KZ Kazakhstan**
Please contact
OOO Weidmüller
Russia
- LT Lithuania**
Please contact
our Representative Office
Weidmüller Interface GmbH
& Co. KG
Latvia
or
ELEKTROS IRANGA
Tinklu g. 29 a
LT-5319 Panevezys
Tel. +370 (45) 582 828
Fax +370 (45) 582 727
info@eliranga.lt
- LU Luxembourg**
Please contact
Weidmüller Benelux B. V.
Netherlands



You can find all Weidmüller addresses and your local contact on the internet at: www.weidmueller.com/countries

Sales company 

Representation abroad 

without representation abroad 

Let's connect.

- LV Latvia**
SIA Abi4
Daugavgrivas 31b
Riga, LV-1007
Tel. +371 674 70999
Fax +371 674 65637
abi_4@tvnet.lv

Representative Office
Weidmüller Interface GmbH
& Co. KG
Udens str. 12-118
Riga, LV-1007
Tel. +371 29254766
Fax +371 676 24562
lgonis.rudaks@weidmueller.com
www.weidmueller.com
- MD Moldova**
BERHORD A & D srl
79/1, str. Milescu Spartaru
MD-2075 Chisinau
Moldova
Tel. +373 (22) 815002
Fax +373 (22) 815007
atiuleanu@berhord.com
www.ad.berhord.com
- ME Montenegro**
Please contact
our Representative Office
Weidmüller Interface GmbH
& Co. KG
Serbia.
- MG Madagascar**
Please contact
Phambili Interface (Pty) Ltd.
South Africa
- MK Macedonia**
Please contact
our Representative Office
Weidmüller Interface GmbH
& Co. KG
Serbia

or
ELEKTRO - SMK dool
UL. III Makedonska brigada
b.b.
1000 Skopje
Tel. +389 22460295
Fax +389 22460298
Elektro-smk@telekabel.net.mk
- MT Malta**
E. S. S., Electrical Supplies &
Services Ltd.
San Gwakkim Road
Mriehel

Tel. +356 21255777
Fax +356 21255999
robert.agius@ess.com.mt
- MU Mauritius**
Mubelo Electrical Ltd.
Office 26, Gateway building,
St Jean Road
Quatre Bornes
Mauritius
Tel. +230 4670989
Fax +230 4654051
richard.mubelo@orange.mu
- MW Malawi**
Please contact
Phambili Interface (Pty) Ltd.
South Africa
- MX Mexico**
W Interconnections S. A.
DE C. V.
Bvd. Hermanos Serdán 698,
Col. San Rafael Oriente
72029 Puebla
Tel. +52 (222) 268 6227
Fax +52 (222) 286 6242
clientes@weidmuller.com.mx
- MY Malaysia**
Connect Plus Technology
Sdn Bhd
No. 43, Jalan PJS 11/22,
Bandar Sunway
46150 Petaling Jaya
Selangor Darul Ehsan
Tel. +60 3 5633 7363
Fax +60 3 5633 6562
paul@cpotech.com.my
www.cpotech.com.my
- MZ Mozambique**
Please contact
Phambili Interface (Pty) Ltd.
South Africa
- NA Namibia**
Please contact
Phambili Interface (Pty) Ltd.
South Africa
- NG Nigeria**
Please contact
Phambili Interface (Pty) Ltd.
South Africa
- NL Netherlands**
Weidmüller Benelux B. V.
Franciscusweg 221
1216 SE Hilversum
P.O. Box 1505
1200 BM Hilversum
Tel. +31 35 626 12 61
Fax +31 35 623 20 44
info@weidmuller.nl
www.weidmuller.nl
- NO Norway**
Sivilingeniør J.F. Knudtzen AS
Billingstadstada 97
1396 Billingstad
PO Box 160
1378 Nesbru
Tel. +47 66 98 33 50
Fax +47 66 98 09 55
firmapost@jfkudtzen.no
www.jfkudtzen.no
- NZ New Zealand**
Cuthbert S. Stewart Ltd.
27 Te Puni Street
Petone
PO Box 38496
Wellington Mail Centre 5054
Tel. (04) 568 6156
Fax (04) 568 6056
csi@cuthbertstewart.co.nz

Cuthbert S. Stewart Ltd
4 Fred Thomas Drive
Aon Building, Ground Floor,
South Entry
Takapuna
PO Box 100 338
North Shore City 745
Tel. (09) 489 1751
Fax (09) 489 1752
cslak@cuthbertstewart.co.nz
- OM Oman**
DAN INTERNATIONAL LLC.
Ghala St. 111
BP 2901
Seeb
Tel. +968 5036 77
Fax +968 5037 55
yedu@danintl.com
- PE Peru**
IMPEXINCA S.A.C.
Calle Ortiz de Zevallos No.
105, Urb. San Antonio
18
Lima, Miraflores
Tel. +51 1 447 5608
info@impexinca.pe
www.impexinca.pe

J & W CIA. S. A.
Calle 6 Mz. D Lte. 23, Urb.
Ind. Grimanesa
1
Callao
Tel. +51 1 572 2539
Fax +51 1 572 0152
contacto@jwcia.com
www.jwcia.com
- PH Philippines**
Enclosure Systems Specialists
Inc.
2276 Don Chino Roces
Avenue Extension
Room 103/105 Narra Building
1231 Makati City
Tel. +63 2 813 8580
Fax +63 2 813 8596
sales_encsys@pltdsl.net
www.enclosuresystemsph.com
- PK Pakistan**
Kana Controls (Pak)
Apartment No. 33 C III,
Chenab Block, Allama Iqbal
Town
Lahore
Tel. +92 42 5419948
Fax +92 42 5422895
nadeem@kanapak.com
www.kanapak.com
- PL Poland**
Weidmüller Sp. z o. o.
ul. Ogrodowa 58
00-876 Warszawa
Tel. +48 22 510 09 40
Fax +48 22 510 09 41
biuro@weidmuller.com.pl
www.weidmuller.pl
- PR Puerto Rico**
Please contact
W Interconnections Inc.
United States
- PT Portugal**
Weidmüller Sistemas de
Interface S. A.
Estrada Outeiro Polima, R.
Augusto Dias da Silva, Lote
B - Esct. 2
São Domingos de Rana
2785-515 Abóboda
Tel. +351 214 459 191
Fax +351 214 455 871
weidmuller@weidmuller.pt
www.weidmuller.pt
- PY Paraguay**
Please contact
CPI SA
Argentina
- RO Romania**
Representative Office
Weidmüller Interface GmbH
& Co. KG
Ionescu Crum Street, No.
1, 1st Tower, 1st Floor,
Office 4
500446 Brasov - Brasov
Business Park
Tel. +40 (268) 446 222
Fax +40 (268) 446 224
claudiu.totea@weidmueller.com
www.weidmueller.com
- RS Serbia**
Representative Office
Weidmüller Interface GmbH
& Co. KG
Ustanicka 189, III sprat
Iokal 7a
11050 Beograd
Tel. +381 11 2885274
Fax +381 11 2885274
zoran.rabrenovic@weidmueller.com
- RU Russia**
OOO Weidmüller
Warshavskoye highway, 25
A, bld. 6
Moskau
117105
Tel. +7 (495) 771-69-40
Fax +7 (495) 771-69-41
Info@weidmuller.ru
www.weidmuller.ru
- SA Saudi Arabia**
Please contact
Weidmüller Middle East FZE
United Arab Emirates
- SE Sweden**
Weidmüller AB
Axel Danielssons väg 271
BOX 31025
SE-200 49 Malmö
Tel. +46 77-143 00 44
Fax +46 40-37 48 60
info@weidmuller.se
www.weidmuller.se
- SG Singapore**
Weidmüller Pte. Ltd.
70 Bendemeer Road
04-03 Luzerne Building
Singapore 339940
Tel. +65 6841 5311
Fax +65 6841 5377
info@weidmuller.com.sg
www.weidmuller.com.sg
- SI Slovenia**
Elektrospoji d. o. o.
Stegne 27
SI- 1000 Ljubljana
Osrednjeslovenska
Tel. +386 1 511 3810
Fax +386 1 511 1604
info@elektrospoji.si
www.elektrospoji.si
- SK Slovakia**
ELEKTRIS s.r.o.
Elektrárnská 1
831 04 Bratislava
Tel. +421 2/4920 0113
Fax +421 2/4920 0119
bratislava@elektris.sk
- SV El Salvador**
Prestegard Electro
11 Avenida Norte No. 240
Edificio Salazar No. 2
San Salvador
Tel. +503 2271 1690
Fax +503 2221 3851
prestegard@navegante.com.sv
- SY Syria**
Please contact
Weidmüller Middle East FZE
United Arab Emirates
- SZ Swaziland**
Please contact
Phambili Interface (Pty) Ltd.
South Africa
- TH Thailand**
Pisanu Engineering Co. Ltd.
Kwang Dingaeng, Khet
Dingaeng
800/2 Soi Trakulsuk, Asoke-
dindaeng Road
Dindaeng, Bangkok
10400
Tel. +66 2 248 2896
Fax +66 2 642 9220
ecsales@pisanu.co.th
www.pisanu.co.th

Representative Office
Weidmüller Pte. Ltd.
37/F, Sathorn Square Building
98 North Sathorn Road
Bangkok, Silom Bangrak
10500
Tel. +66 2 105 6300
Fax +662 105 6300
info@weidmuller.com.sg
- TN Tunisia**
Please contact
Weidmüller E. U. R. L.
France
- TR Turkey**
Weidmüller Elektronik Ticaret
Ltd. Sirketi
Kavacık Mah. Orhan Veli Kanık
Caddesi 9/1
34810 Beykoz / Istanbul
Tel. +90 (216) 537 10 70
Fax +90 (216) 537 10 77
info@weidmuller.com.tr
www.weidmuller.com.tr
- TW Taiwan**
Weidmüller (Hong Kong)
Limited
No. 3, Lane 89, ChungYang
N. Rd.
24148 SanChuang City,
Taipei
Tel. +886 921 949 751
roy.lin@weidmueller.com.hk
- TZ Tanzania**
Please contact
Phambili Interface (Pty) Ltd.
South Africa
- UA Ukraine**
LLC WM UKRAINE
Levanevskogo str. 6
Kiev
3058
Tel. +38 044 490 32 48
Fax +38 044 490 32 49
info@wm-ua.com.ua
wm-ua.com.ua/

Representative Office
Weidmüller Interface GmbH
& Co. KG
Z. office 303
7-D, Zdobunivska str.
Kiev, 2081
Mobile +38 050 440 25 24
info.ua@weidmueller.com
- US United States**
W Interconnections Inc.
821 Southlake Boulevard
Richmond Virginia 23236
Tel. +1 (804) 794-2877
Fax +1 (804) 379-2593
info@weidmuller.com
www.weidmuller.com
- UZ Republic of Uzbekistan**
Please contact
OOO Weidmüller
Russia
- VN Vietnam**
AUMI Industrial Equipment &
Automation Company Limited
E1, La Thanh Hotel
218 Doi Can Street
Lieu Giai Ward, Ba Dinh
District
Hanoi City
Tel. +84 4 37628601
Fax +84 4 62661391
aumi@aumi.com.vn
www.aumi.com.vn

Representative Office
Weidmüller Pte. Ltd.
Level 16 Saigon Tower
Building
29 Le Duan Street
District 1
Ho Chi Minh
Tel. +848 3520 7717
Fax +848 3520 7604
info@weidmuller.com.sg
- ZA South Africa**
Phambili Interface (Pty) Ltd.
PO Box 193
1609 Johannesburg, Edenvale
5 Bundo Road, Sebenza
1610 Johannesburg
Tel. +27 (11) 4521930
Fax +27 (11) 4526455
info@weidmuller.co.za
www.weidmuller.co.za
- ZM Zambia**
Please contact
Phambili Interface (Pty) Ltd.
South Africa
- ZW Zimbabwe**
Please contact
Phambili Interface (Pty) Ltd.
South Africa